

TEM

On | Off and everything in between

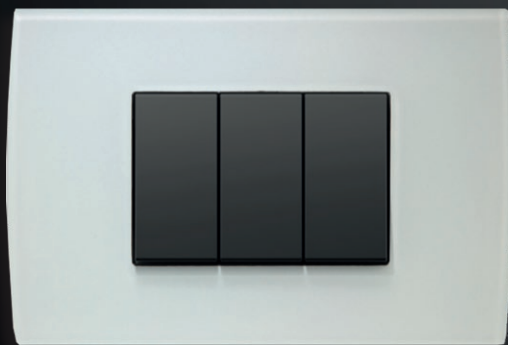

2021

ТЕМА

Добре дошли в семейството **М O D U L**

Welcome to the **М O D U L** family

Ние разширяваме и усъвършенстваме модерната гама ключове за всички видове помещения.

We are expanding and perfecting the modern Modul switch family for all types of rooms.

discovering new insights

ОТКРИВАНЕ НА НОВИ ПРОЗРЕНИЯ



MODUL
—line—



MODUL
—soft—



MODUL
PURE

MODUL

Дизайнерските продуктови линии Pure, Line и Soft отразяват модерен, съвършен и независим стил на живот. Можете да избирате от широк и богат набор от цветове, модели и контакти, които да подхождат на желаната атмосфера и настроение.

The Pure, Line and Soft design lines reflect a modern, sophisticated and independent lifestyle. You can choose from a wide and rich selection of colours, patterns and shapes to alter the appearance of your switches and sockets so that they fit the desired atmosphere and mood.

PURE

естествени материали
natural materials

дърво wood
метал metal
стъкло glass

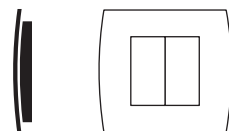

—line—



прави линии
straight lines

soft



меки линии
soft lines

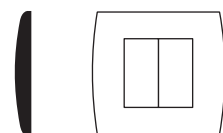
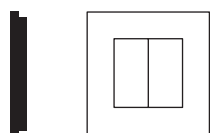

PURE



прекрасен живот wonderful living

Историята на продуктовата гама Pure води началото си от чистотата и непорочността на един нов свят. Усещането за естествени мотиви се преплита с изтънчения вкус на линиите и формите, съчетавайки се с тенденциите на съвременната технология.

From the cleanliness and purity of a new-born world stems the story of the Pure line. The touch of natural motifs is intertwined with a sophisticated taste for lines and form and interwoven with threads of state-of-the-art technology.



PURE

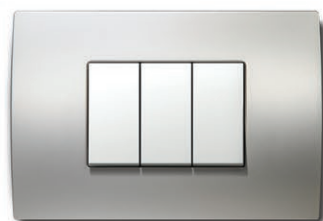



усещане за природа feeling of nature

Продуктовата гама ключове Pure се отличава с използваните естествени материали: метал, дърво и стъкло. Уникалният и дизайн дава усещане за нещо необикновено. Впечатляващо, но въпреки това ненавтрпчиво. Излъчва се чувственост и съвършенство, усещане за висок стандарт, и разбира се, чистота.

The Pure switch line is distinguished by its natural materials: metal, wood and glass. Its unique design gives it a special touch. It is striking yet unobtrusive. It radiates sensuality, sophistication, high standards and, of course, cleanliness.

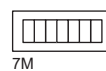
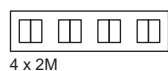

line



хармония от прави линии harmony of straight lines

Подгответе се за елегантното съвършенство на строгите форми. Опитайте прекрасните повърхности, които деликатно се съчетават с модерните елементи във вашата стая. Специално за вас сме вградили технологията „Soft Touch“, която превръща всяко докосване в уникално изживяване.

Prepare for the elegant perfection of straight shapes. Try brilliant surfaces that gently play with modern elements of your room. We have incorporated “Soft Touch” technology especially for you, turning every touch into a unique experience.



line

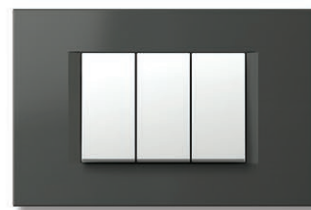
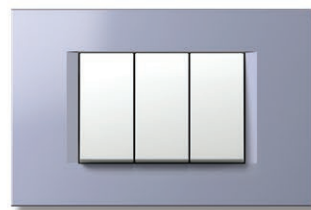
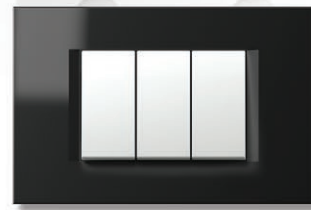
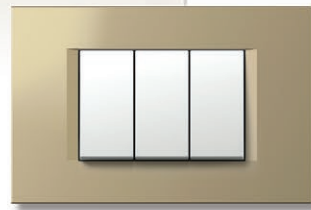
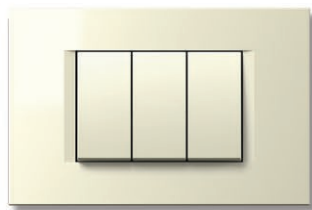
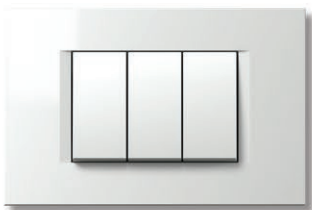

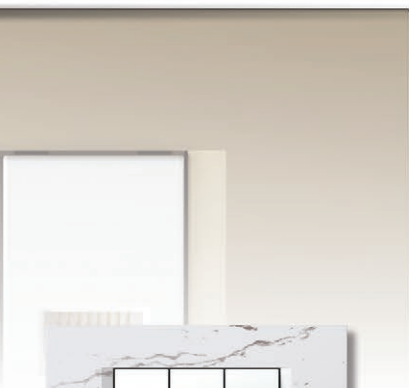

модерен дизайн modern design

Правите и гладки линии определят дизайн, неподвластен на времето. Перфектно правият изящен профил и ергономичното меко докосване придават впечатляващо елегантен външен вид от всеки ъгъл.

Its straight, smooth lines make for a timeless design. Its perfectly straight, sleek profile and soft-touch ergonomics give it an amazingly elegant appearance from all angles.

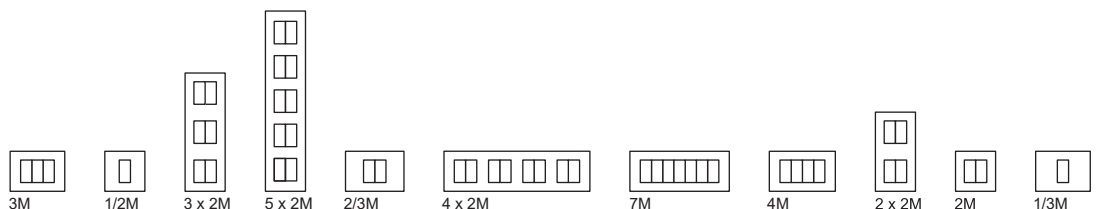

soft



МЕКОТА ВЪВ ВАШИЯ ДОМ softness in your home

Нека заоблените форми и леките преходи
внесат мекота във вашия дом.

Let the rounded shapes and soft transitions
bring softness into your home.



soft





ТОПЪЛ ДОМ a warm home

Перфектни меки форми, оформени с изтънчен избор от цветове и специални покрития, които дават усещане за специално докосване.

Perfectly soft shapes rounded off by a subtle selection of colours and special coatings for a special touch.

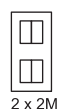
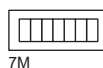
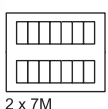



антрацит anthracite

Ние добавяме към нашата продуктова гама още две цветови впечатления – АНТРАЦИТ и ТИТАН. И двата цвята удовлетворяват изтънчения вкус за стил и допълване на пространствените детайли на нашите клиенти в съответствие с желанията им. Сега вие можете да постигнете хармония в своя модерен апартамент.

We are adding two colour experiences to our range – ANTHRACITE and TITANIUM. They both satisfy our customer's sophisticated sense of style and complement the details of spaces according to their wishes. Now you can upgrade your modern apartment in harmony.

МОДЕРНИ ЦВЕТОВЕ

trendy colours



ТИТАН
titanium

МНОГОФУНКЦИОНАЛНОСТ

multifunctionality



ЕСТЕТИКА

aesthetics

Ние създадохме за вас по-големи панели, които ви дават възможност да управлявате няколко функции от едно и също място. Те се предлагат в дизайнерските гами LINE, SOFT и PURE. В панелите, направени от естествени материали, се прилагат повтарящи се дизайнерски елементи, които допринасят за високото им естетично ниво.

We have created larger cover plates for you that allow you to manage multiple functions from one spot. They are available in the LINE, SOFT and PURE design ranges. The cover plates, which are made from natural materials, utilise the repetition of design elements to elevate them to a high aesthetic level.



универсален димер

universal dimmer

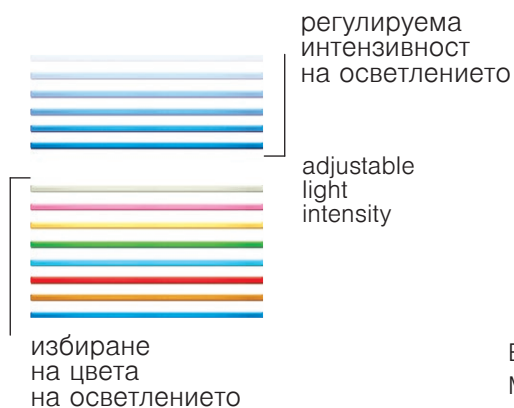
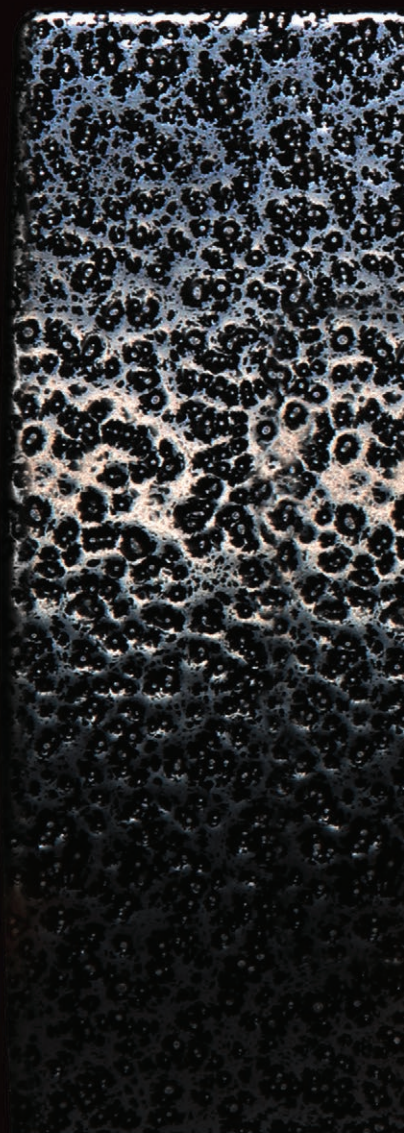

choosing
illumination
colour

В тъмнината Touch предоставя нежна и мека обкръжаваща светлина. Маркира се светлинно петно с натискане на ключа и мястото се осветява уютно. Можете да избирате между осем различни цвята мека светлина и да настройвате яркостта на осветлението според настроението си.

In the dark Touch becomes a tender soft ambient light. It marks the spot of a switch and gently illuminates a place. You can choose among eight different colours of tender light and adapt its brightness according to your mood.

TOUCH®

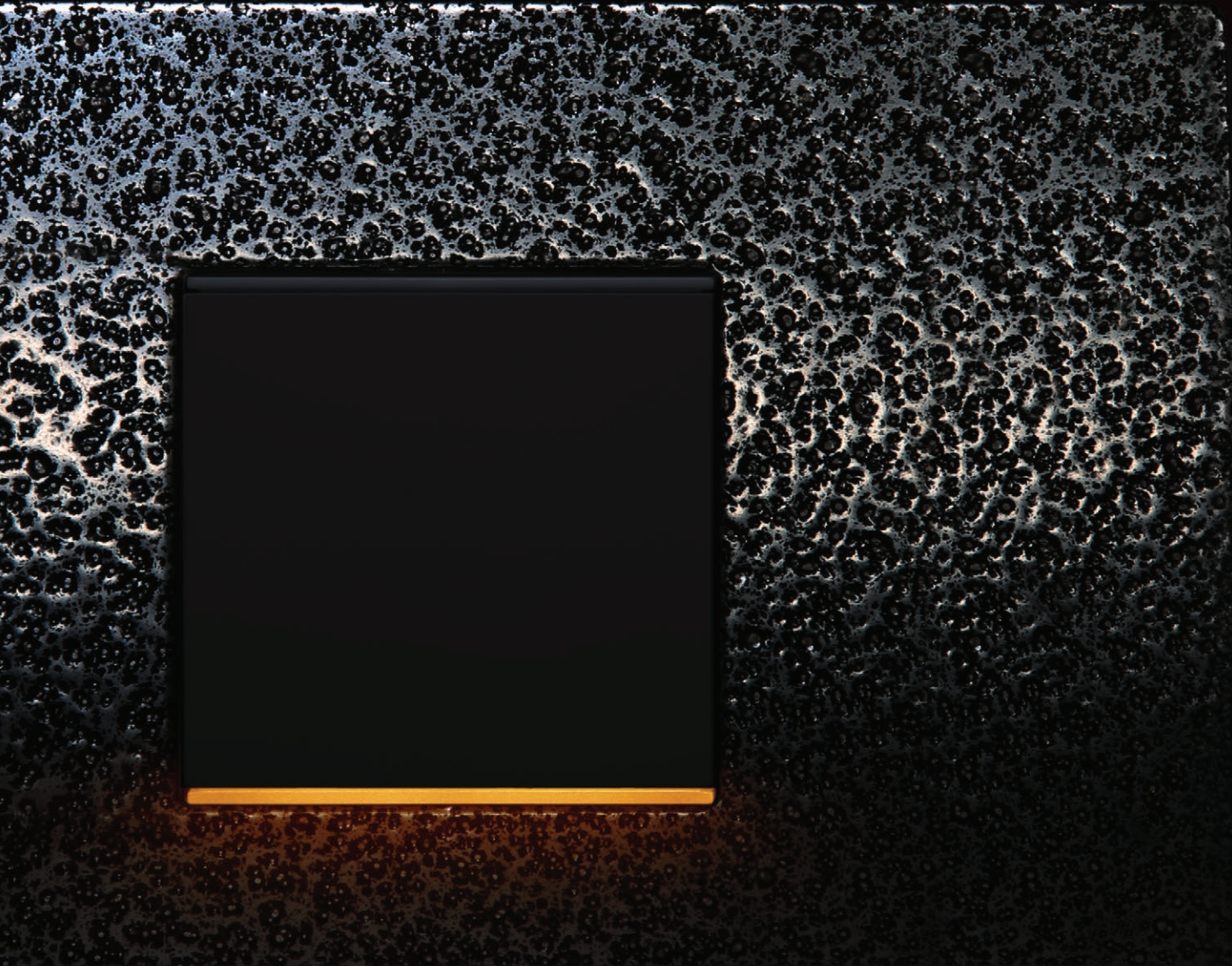

СВЕТЛИНА, КАКВАТО НЕ Е ВИЖДАНА НИКОГА ПРЕДИ light as never seen before

Димираната светлина създава спокойна, чувствена и романтична атмосфера. Тя е запазената марка на романтичните места и спокойните вечерни часове, прекарвани у дома или на работа. Включването е меко и удължено. Така не само се удължава очаквания експлоатационен живот на лампите, но и преходът от тъмно към светло е по-бавен и много по-приятен. Touch ви дава възможност да димирате осветлението навсякъде, независимо от вида на лампите.

A dimmed light makes peaceful, sensual and romantic atmosphere. It is a trade mark of romantic places and quiet late evening hours spent at home or at work. Switching is soft and extended. It does not only prolong the lamp life expectancy, but also changes darkness into light in a slower and much more pleasant way. Touch enables you to dim the light anywhere, regardless of the type of lamps.





ВСИЧКО НА ЕДНО МЯСТО

everything in one place

Вашият дом е центърът на живота ви. Множеството устройства, които използвате, изискват голям брой конектори и контакти. Създайте си собствен мултимедиен център, който да ви даде възможност да свързвате и използвате голям брой компоненти на едно място.

Your house is the centre of your life. The multitude of devices you use requires a number of connectors and sockets. Create your own multimedia centre, one that will allow you to connect and use a multiple number of different components in one place.





ИНОВАЦИОНЕН КОНТРОЛЕР НА ТЕМПЕРАТУРАТА innovative temperature controller

Създайте си удобства като контролирате температурата във вашите жилищни и работни помещения с интелигентен термостат през всички сезони. Той дава възможност да се управляват уредите за отопление и охлаждане и има функция за екологична употреба.

Make yourself comfortable by controlling the temperature in your living and working rooms during all seasons with a smart thermostat. It allows you to control heating and cooling devices and features an eco-function.

КОМФОРТ ВЪВ ВАШАТА СТАЯ ²⁷

comfort in your room



удобство при използване
convenience of use



СЕНЗОРНО ЗАДЕЙСТВАНЕ

Ключът със сензорно задействане ви дава възможност да се наслаждавате на стила на модерен живот, като ви позволява да включвате и изключвате осветлението без нужда от физическо взаимодействие. Тази възможност е особено полезна, когато ръцете ви са заети или мръсни, тъй като можете да включите желаното осветление без излишни усилия. The touchless switch allows you to enjoy a modern lifestyle, enabling the turning on and off of your lights, without the need for physical interaction. This option is very useful when you find yourself with your hands full, or dirty, as you can achieve the desired lighting without undue fuss.



МОДЕРНО ОСВЕТЛЕНИЕ

modern illumination





3D лампа

3D lamp

Ускореното темпо на живота е причина непрекъснато да бъдете засипвани с обилна информация. Цветната 3D лампа предоставя елегантно решение за информационни и упътващи знаци. Ние можем да създаваме графични изображения според нуждите ви.

The rapid pace of life means you are constantly being bombarded with a plenty of information. 3D colour lamp provide an elegant solution for information and direction signs. We can make graphics according to your wishes.



BIOPASS – ОТКЛЮЧВАНЕ БЕЗ КЛЮЧ

BIOPASS – keyless unlocking

BIOPASS е ново поколение ключ за отключване без ключове. Обединява напредничава технология за разпознаване на пръстови отпечатащи и бързото отключване на входни врати.

Само поставете пръста си върху ключа Biopass и вратата на дома или офиса Ви ще се отвори. Толкова лесно и толкова наистина безопасно. Лесно управление посредством мобилно приложение.

BIOPASS is the new generation of switches for keyless unlocking. It combines advanced fingerprint recognition technology with quick front door opening.

Simply put your finger on the Biopass switch and the doors to your home or office will open. It is so easy to use and incredibly secure. You can manage it effortlessly via the mobile app.

повишена сигурност ³³
improved security



ИНДИВИДУАЛНОСТ

individuality



нека бъде само ваше

make it your own

Бъдете различни от другите. Направете си ключ според вашия собствения вкус. Можете да избирате между различни цветове на рамката, а ние можем да ги декорираме с избрани от вас графични изображения или знаци. Изберете цвета на осветлението, който ще подхожда на атмосферата във вашата стая.

Be different. Make a switch according to your taste. You can choose between different frame colours and we can decorate them for you with custom graphics or signs. Choose a illumination colour that suits the ambience of your room.



ПОДХОДЯЩО ЗА ИЗПОЛЗВАНЕ В ОБЩЕСТВЕНИ МЕСТА
suitable for public use



КАЧЕСТВО И ДЪЛГОТРАЙНОСТ quality and durability

Качествените и дълготрайни материали осигуряват дълъг живот на модулните ключове и контакти MODUL. Системата е подходяща за монтаж и безпроблемно използване в обществени съоръжения, бизнес помещения, места за настаняване на туристи, търговски центрове и спортни обекти. Тя се съчетава отлично както с модерна архитектура, така и с класически интериор.

Quality and durable materials ensure the long lifetime of the MODUL modular switches and sockets. The system is suitable for mounting and carefree use in public facilities, business premises, tourist accommodation, shopping centres, schools and sports facilities. It fits perfectly in both modern architecture and classical interiors.





мощни USB зарядни устройства powerful USB chargers

Мощните USB зарядни устройства на Modul дават възможност за бързо и лесно зареждане на вашите смартфони, таблети и други електронни устройства чрез стандартно USB свързване. Те се предлагат с размери от 1M и 2M и са отлични за използване в частни и обществени помещения.

The powerful Modul USB chargers enable the fast and simple charging of your smartphones, tablets and other electronic devices via a standard USB connection. They are available in 1M and 2M sizes and are perfect for use in private and public rooms.

бързо зареждане

fast charging



модерна работна среда a modern working environment





естетични алуминиеви канали за кабели aesthetic aluminium trunkings

Организирайте вашите офисни, училищни и работни зони. Забравете за видимите кабели и неудобните удължители. Елегантните и модерни алуминиеви канали за кабели предоставят изобилно място за електрическите инсталации. Ключовете, контактите и комуникационните елементи са с лесен достъп и са на разположение в подходящите места за използването им. Те лесно могат да се адаптират или надграждат. Създайте приятна и функционална околна среда.

Organise your office, school and work areas. Forget visible cables and unpractical extensions. The elegant and modern aluminium trunkings offer plenty of space for electrical installations. Switches, sockets and communication elements are easily accessible and available in the right place to be used. They can be easily adapted or upgraded. Arrange a pleasant and functional environment for yourself.

модулен принцип

modularity

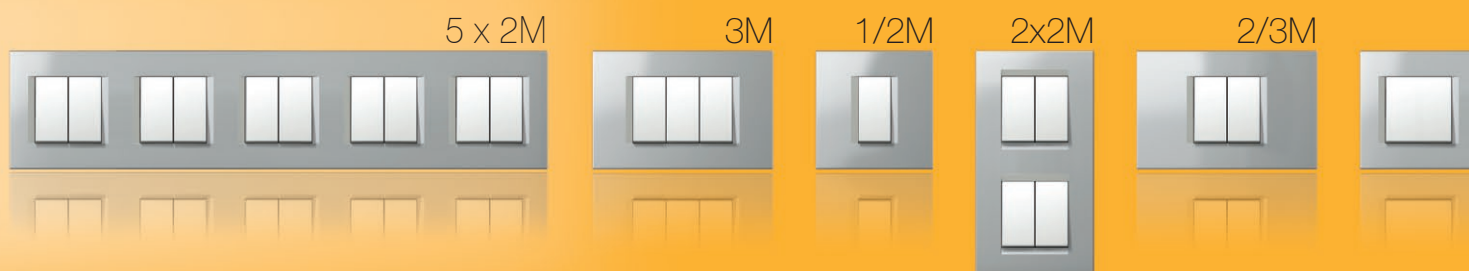

Ние сме разработили универсална система, която се характеризира с разнообразие от елементи, което ви позволява да създадете всяка желана конфигурация. Основните елементи на системата са модулни и може да се комбинират хоризонтално или вертикално.

We have designed a comprehensive system that features a variety of elements, allowing you to create any configuration you wish. The basic elements of the system are modular and can be combined horizontally or vertically.



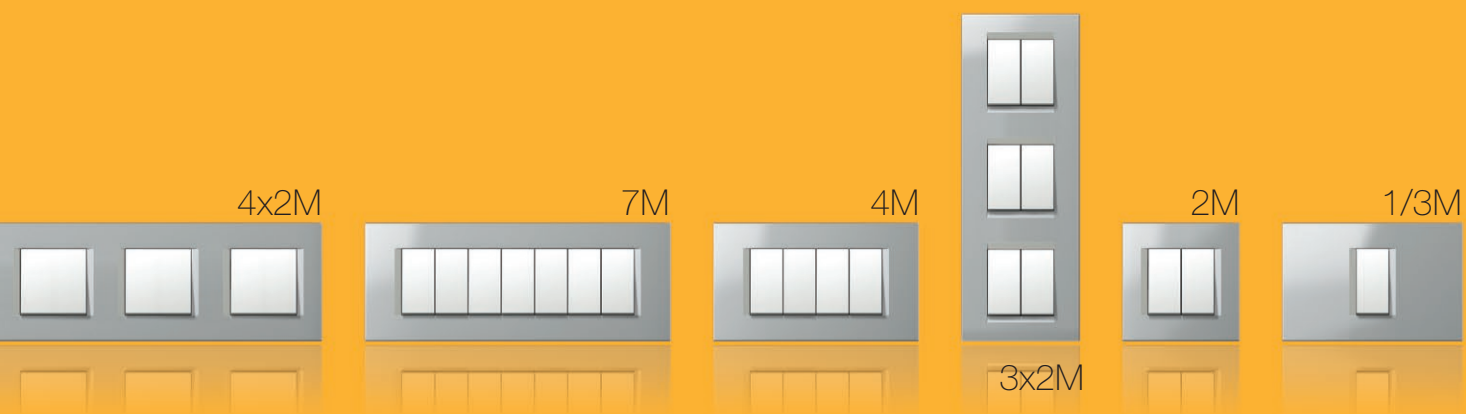

$$1M = \text{[rectangle]}$$

$$2M = \text{[rectangle]} \text{ [rectangle]} = \text{[square]}$$

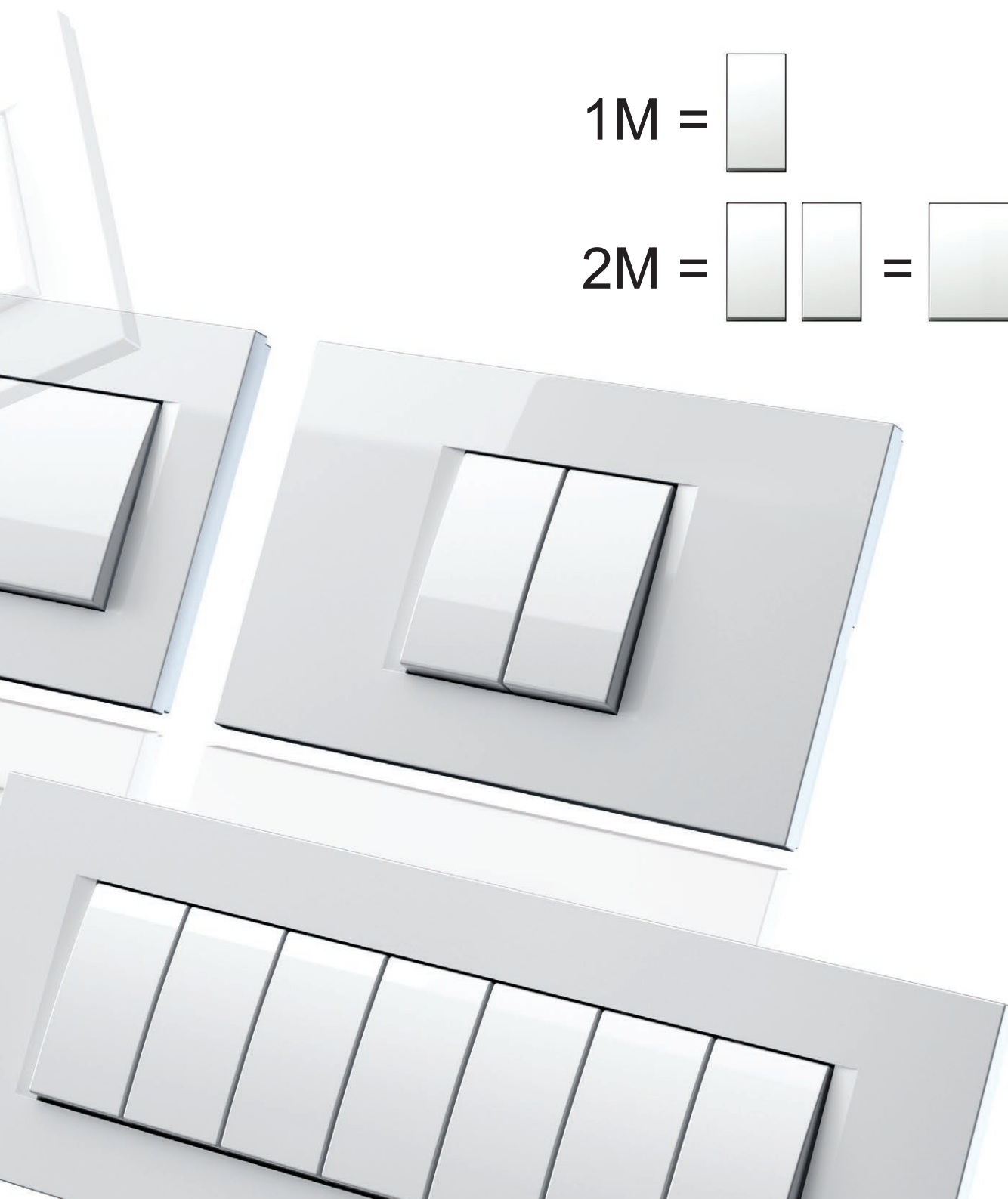

универсалност

universality

Системата се характеризира с обширен избор от елементи и лесен монтаж. Комплектите ключове могат да се полагат по няколко различни начина, независимо от това дали конзолата е кръгла или правоъгълна, самостоятелна или серийна.

The system features a comprehensive selection of elements and is easy to install. Switch sets can be positioned in many different ways, regardless of whether the box is round or rectangular, individual or serial.



modulmanager.tem.si

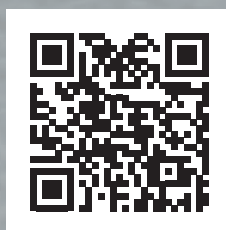

Опитайте инструмента „ModulManager“, който ще ви помогне за съставите която и да и желана комбинация.

Try out the “ModulManager” tool, which will help you put together any combination you want.

решения за 4 ключа solutions for 4 switches

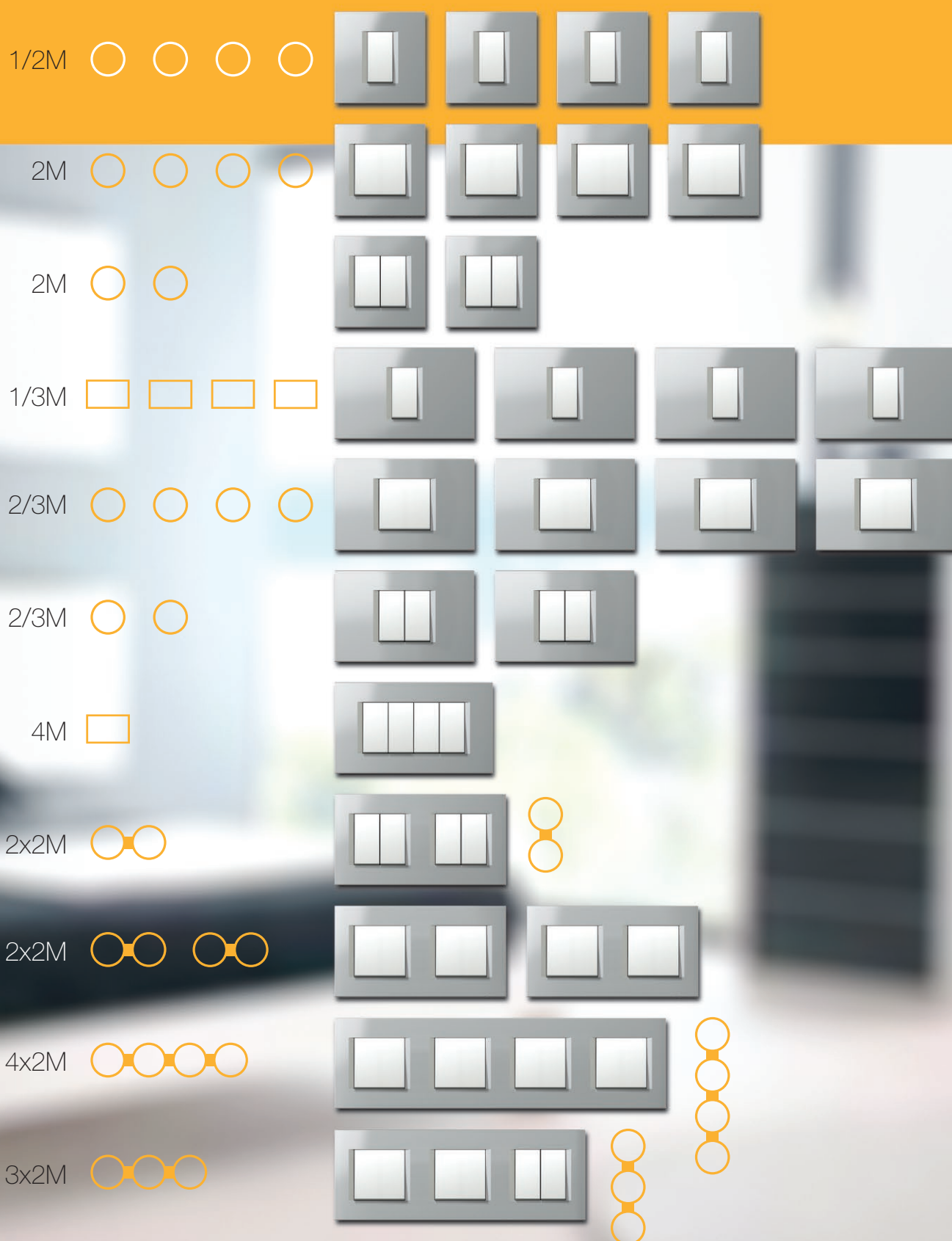

MODUL MANAGER

лесен и бърз / easy and fast





конфигуратор за ключове и контакти configurator of switches and sockets

Modul Manager ви дава възможност да направите бързо пълен опис на ключовете от самия обект или от комфорта на от дома си. Ние сме подготвили уникален начин за поръчки, който е практичен и бърз. Можете да избирате цвета на ключовете, както и формата на рамките, което означава, че можете да ги нагодите към наличното пространство или нуждите на клиента. Защо не опитате? Трябва ви само смартфон, таблет или компютър и <http://modulmanager.tem.si>.

The Modul Manager allows you to perform a complete and quick inventory of switches from the building site itself or from the comfort of your own home. We have prepared a unique ordering method, which is both practical and quick. You can select the colours of the switches, as well as the shape of the frames, meaning you can tailor them to your space or the client's demands. Why not try us out? All you need is a smartphone, a tablet, or a computer and <http://modulmanager.tem.si>.

функционалност

functionality

Modul е създаден за тези, които могат да оценят един грижливо конструиран продукт. Системата изисква по-малко място, тъй като всяка комбинация от функционални елементи може да се помести в една и съща рамка. Тя е подходяща за нови, както и за реновирани сгради.

The Modul was developed for those who can appreciate a thoughtfully designed product. The system takes up less space, as any combination of function elements can be fitted inside the same cover plate. It is suitable for new, as well as renovated buildings.



Също така, Modul Soft се предлага в антибактериално изпълнение AW.

The Modul Soft is also available in an antibacterial solution AW.

декоративни панели
decorative cover plates

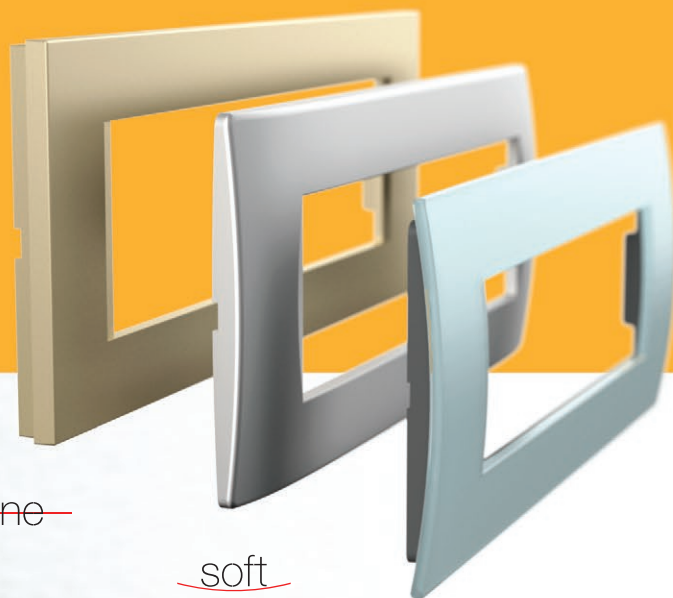

—line—

—soft—

PURE



функционални елементи
function elements



простота simplicity

Функционалните елементи се монтират лесно в монтажната рамка. Решението „щракване за поставяне, щракване за изваждане“, което сме разработили за вас, намалява времето за монтиране. Достъпът до контактите за съединяване е лесен откъм предната страна.

The function elements are easily fitted inside the mounting frame. The “klik-in, klik-out” solution we have developed for you will reduce installation time. The connection contacts are easily accessible from the front.

line
soft
PURE

klik-in, klik-out

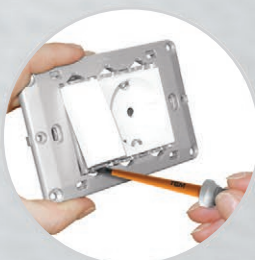
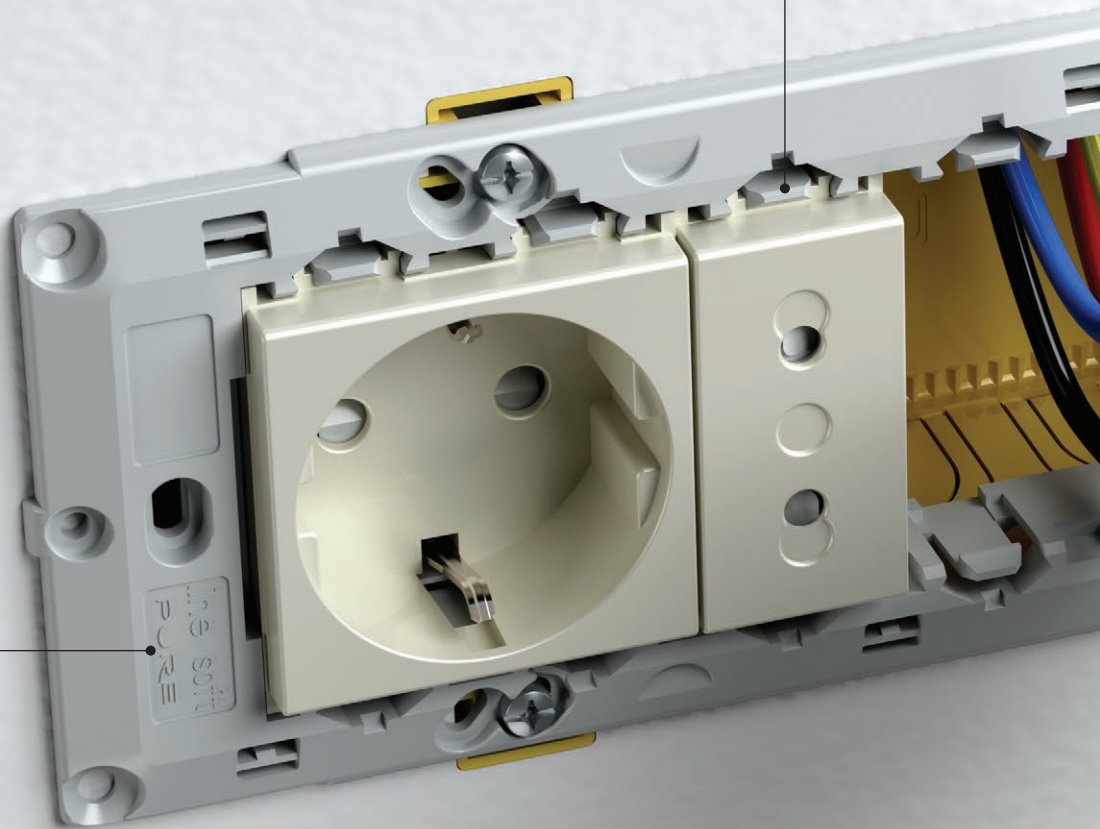

„щракване за поставяне, щракване за изваждане“ – лесно и бързо, не са нужни винчета.

“klik-out” - simple and quick, no screws necessary.

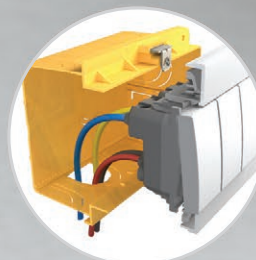

Правоъгълните конзоли предоставят повече място за съединителните проводници.

Rectangular boxes have more space for connection wires.

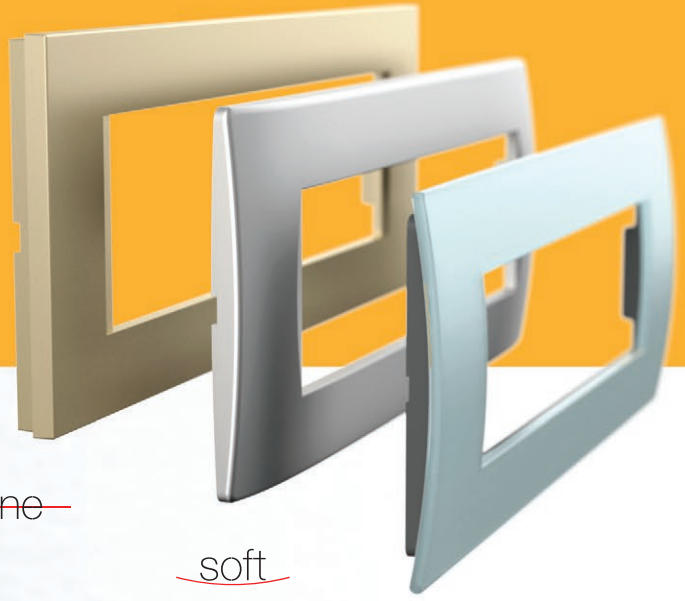
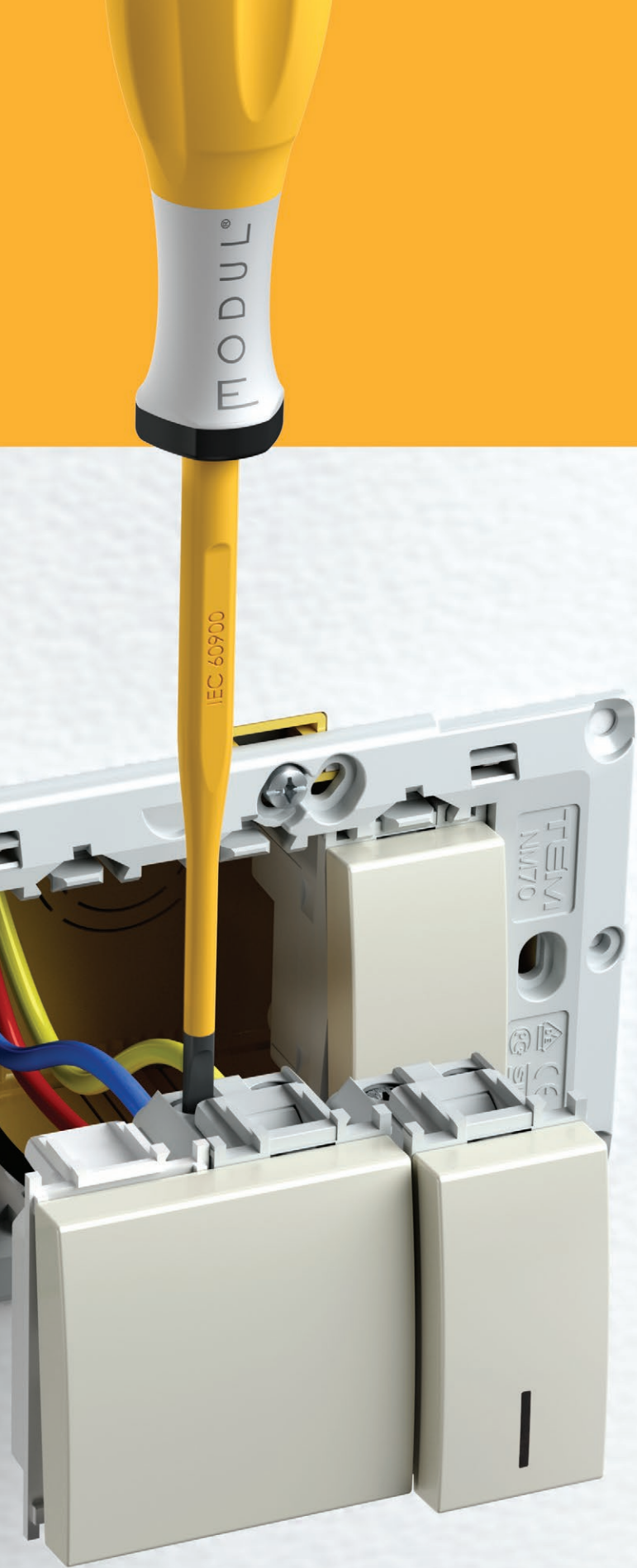

~~line~~

soft

PURE

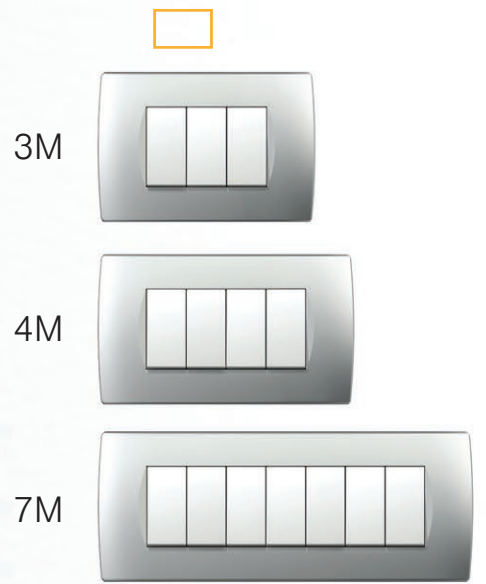

3M

4M

7M

ВЪЗМОЖНОСТИ за комбиниране combinability

Modul предоставя голям брой възможности даже с кръгли конзоли. Можете да ги комбинирате хоризонтално или вертикално, самостоятелно или във вид на групи. Металната монтажна рамка гарантира отлична стабилност дори при работа с кръгли елементи и е подходяща за всякакви декоративни панели.

The Modul enables a many possibilities even with round boxes. You can combine them horizontally or vertically, individually or in groups. The metal mounting frame ensures excellent stability even with rough use and is suitable for any decorative cover plates.

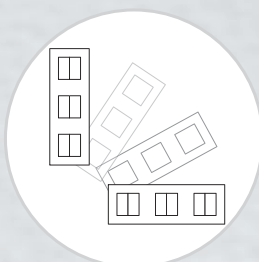
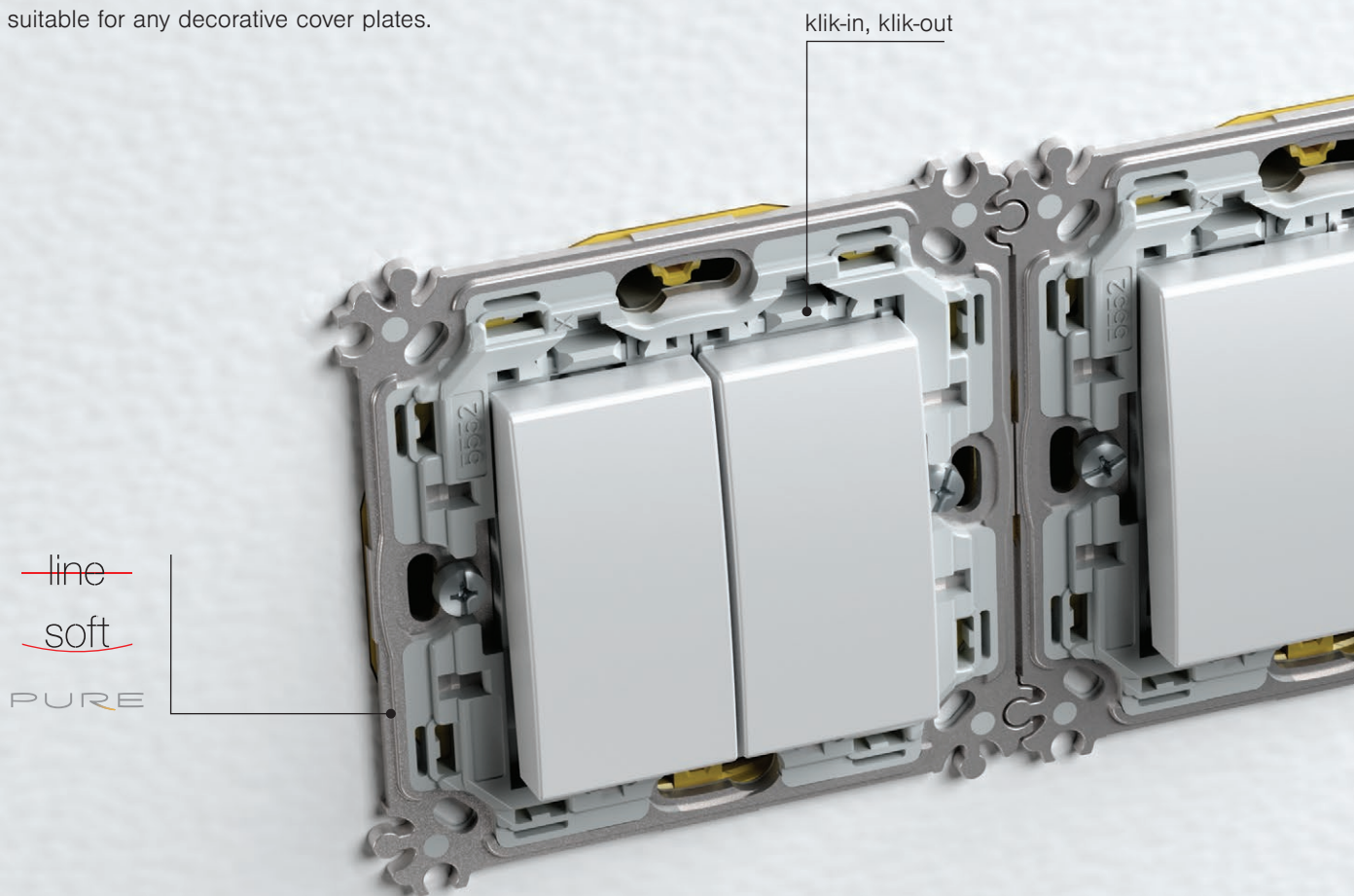

Един и същи панел може да се разполага хоризонтално или вертикално.

The same cover plate can be positioned horizontally or vertically.

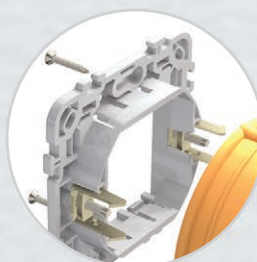

Монтажните рамки може да се закрепват с винтове или с крачета.

Mounting frames can be fixed with screws or claws.

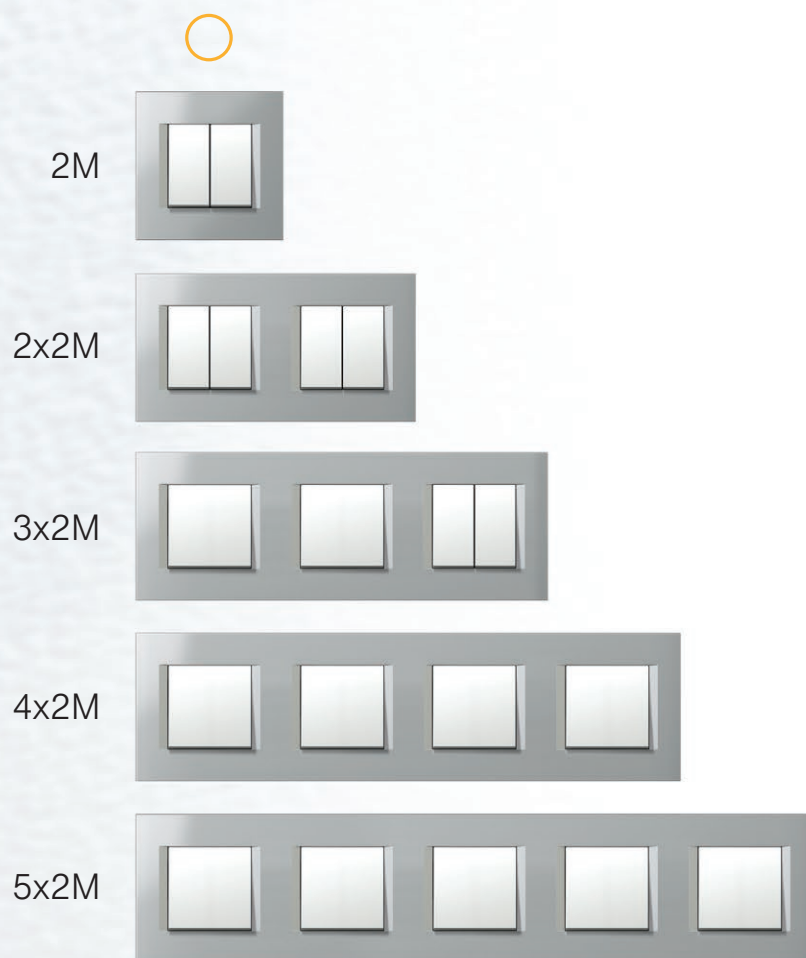
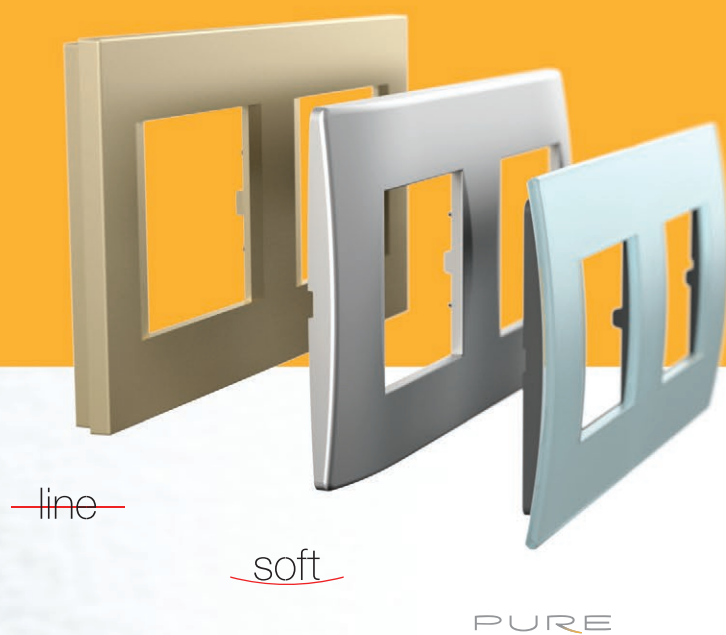

Монтажните рамки 2M лесно се обединяват в групи.

2M mounting frames are easily joined into groups.

универсальность

universality

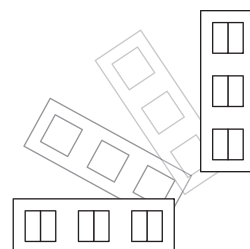
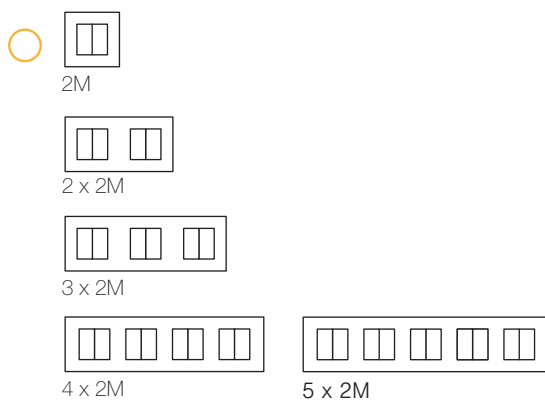
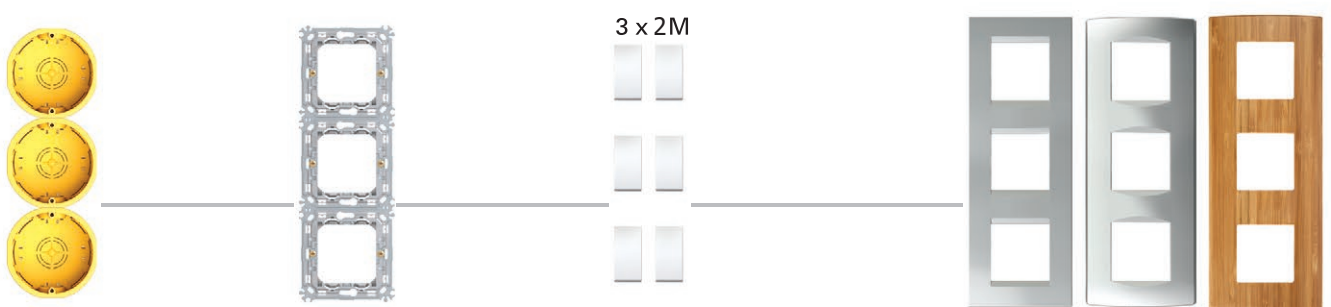
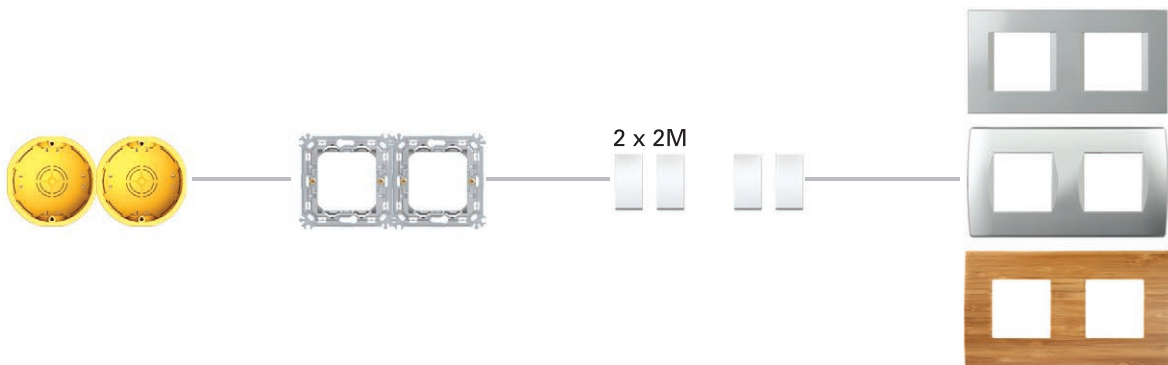
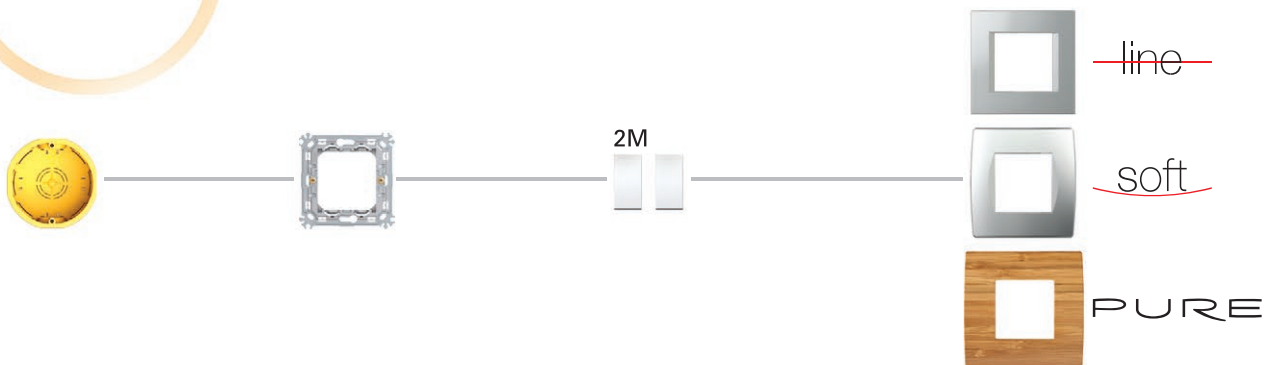

The system is universal and can be fitted in both round and rectangular boxes.

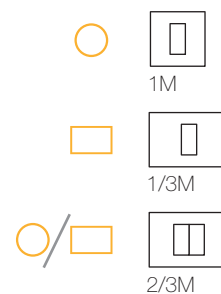
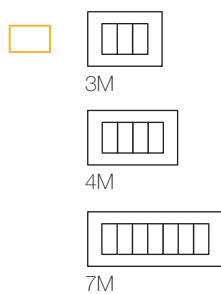
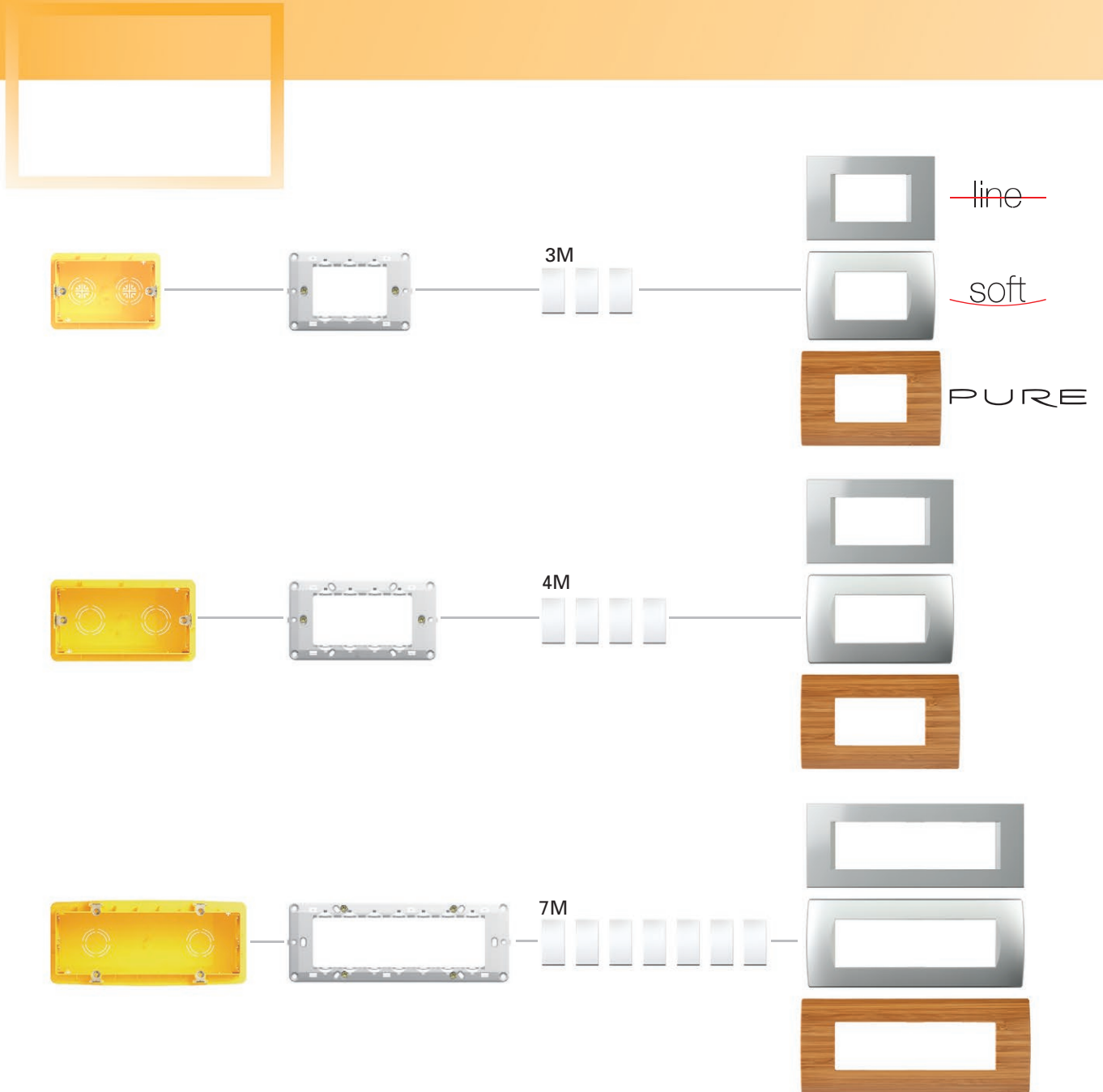

функционални елементи

function elements

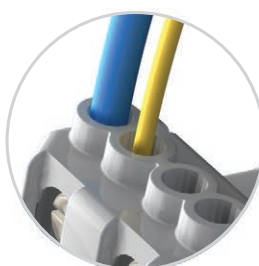
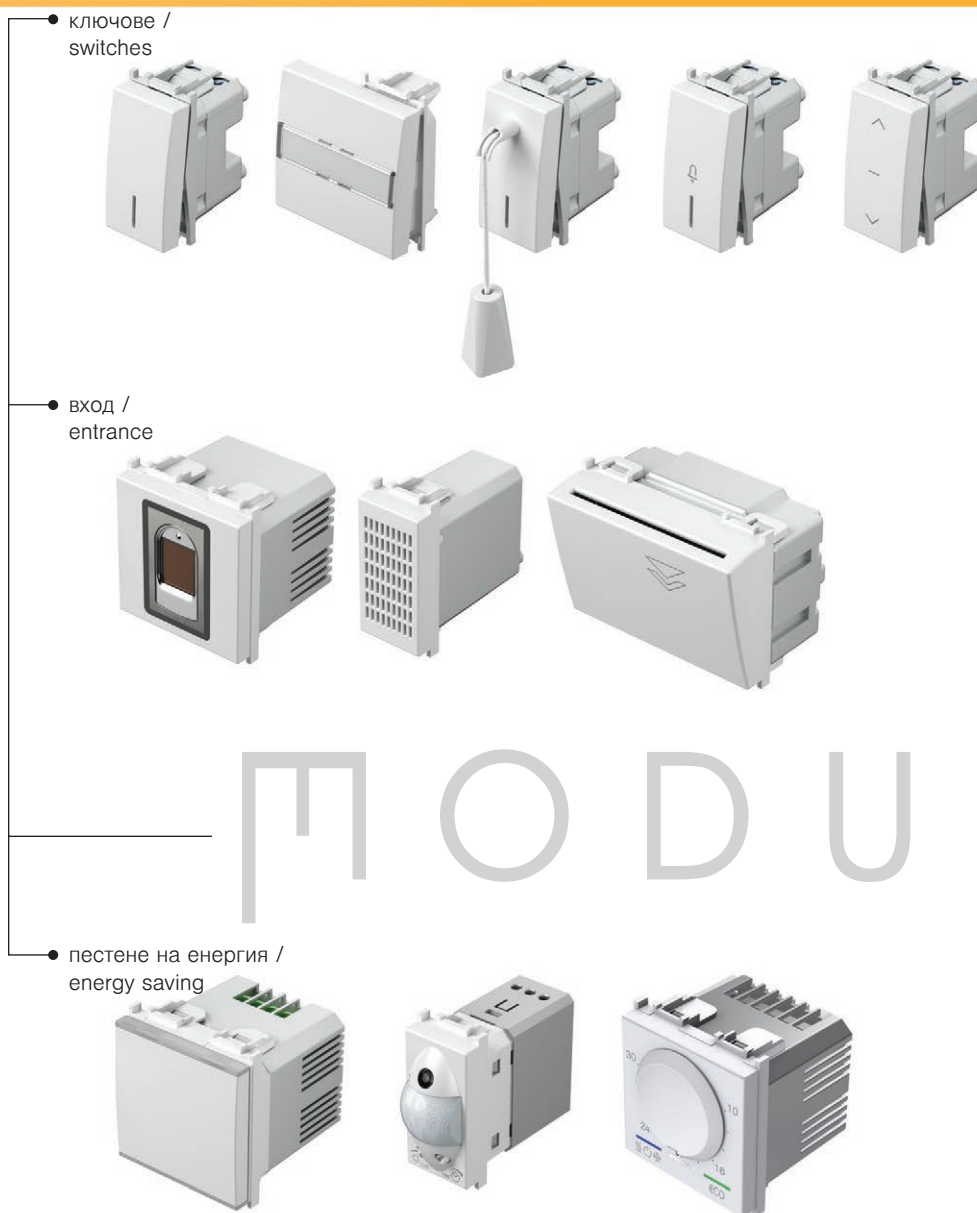

Надеждно свързване, дори при използване на проводници с различно сечение.
Reliable connection even when different size of wires are used.



Дълъг експлоатационен живот на ключовете и съответствие с изискванията на международните стандарти.
Long-life of switches and adequacy to the international standards.

Ние сме разработили широк набор от функционални елементи за продуктова гама Modul. Можете да ги използвате както за малки, така и за сложни инсталации.

We have designed a wide selection of function element for the Modul family. You can use them to design both simple and complex installations.



• контакти / sockets

• развлечения / entertainment

• осветление / illumination



Всички контакти са оборудвани за безопасно изключване, което гарантира защитата на контактите, които са под напрежение.

All the sockets are equipped with a safety shutters assuring the protection to live contacts.



16 AX

КОНТАКТИ

Ключът е с висока надеждност, благодарение на своите контакти със сребърни нитове.

The switch is highly reliable via its silver rivets contacts.

уникален обхват на използване

unique range of usability

Modul Soft AW
антибактериално изпълнение/
antibacterial solution



MODUL

CUBO IP20

конзоли за външен монтаж
surface mounted boxes



CUBO IP55

конзоли за външен монтаж
surface mounted boxes



IP44

конзоли за скрит монтаж
flush mounted



Вие обзавеждате своя дом, офис или работилница?
Modul е подходящ както за жилищни и за работни зони,
така и за частни или обществени сгради. Уникално е, че ключовете
и контактите могат да се монтират, където са необходими.

Are you furnishing your home, office or workshop? The Modul is
suitable for living as well as working spaces and both private and public
buildings. It is unique in that the switches and sockets can be fitted
wherever they are needed.

D

тухла
brick

H

куха стена
hollow wall

B

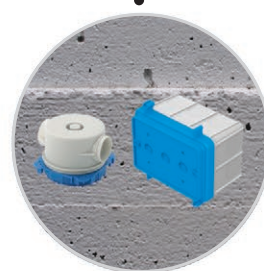
бетон
concrete

• функционални елементи/
function elements

ключове / switches
контакти / sockets
комуникации / communications
датчици / sensors
регулатори / regulators
осветление / illuminations

MA

системи за канали за кабели
trunking systems

MO

разпределителни табла
distribution boards

MT

подови конзоли
floor boxes

решения за скрит монтаж

flush mounted solutions

тухла / brick

Modul е подходящ за всички видове стени и може да се използва в обикновени конструкции, както и за кухи стени или бетон. Инсталирането е лесно и ви дава възможност лесно да инсталирате и комбинирате правилните разстояния за правоъгълни и кръгли конзоли. Използваните материали отговарят на високи стандарти.

The Modul is suitable for all wall types and can be used in conventional, hollow wall or concrete constructions. It is easy to install and enables you to combine rectangular or round boxes at the proper distances. The materials used are compliant with high standards.



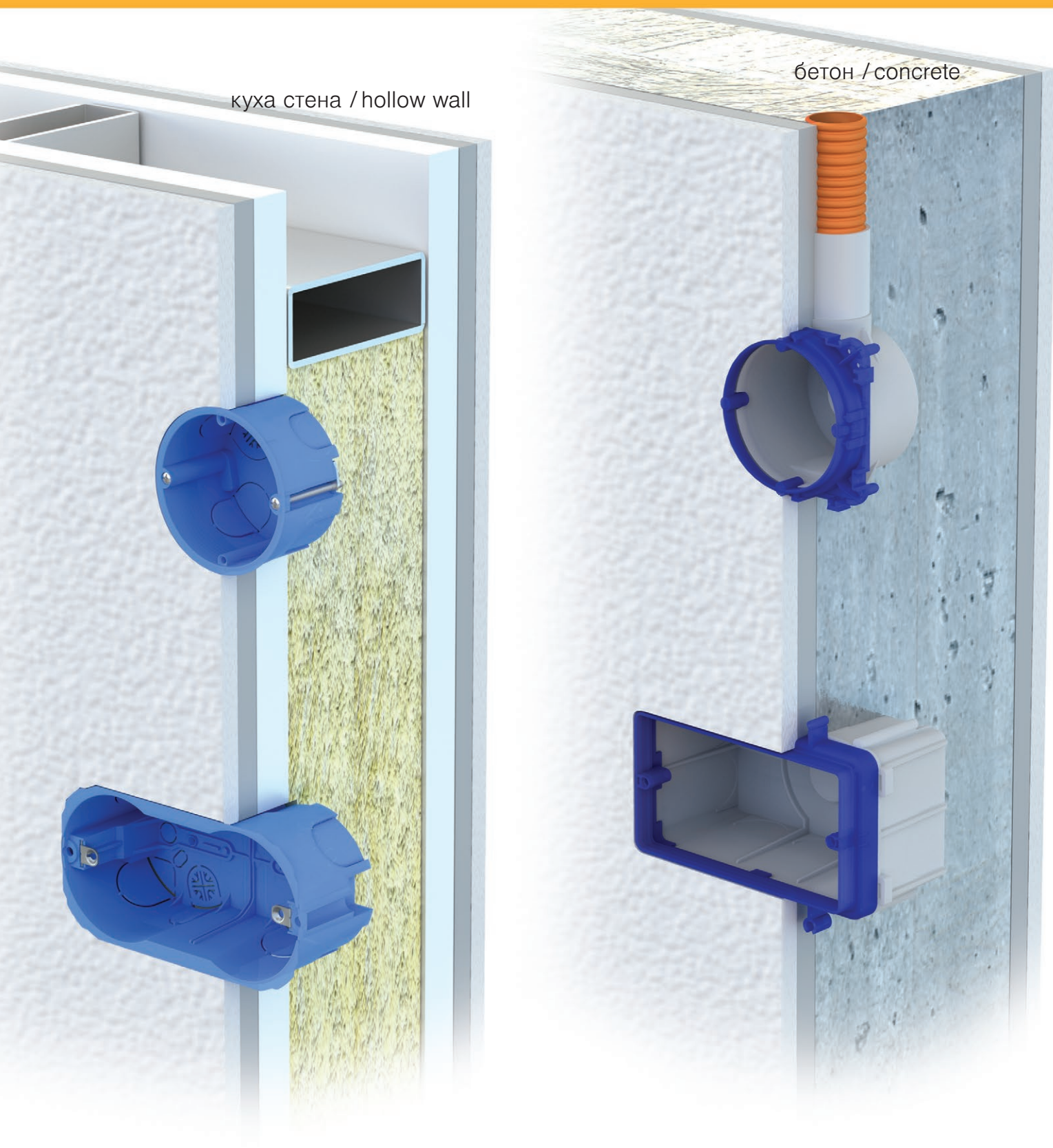

други решения

other solutions

IP44
конзоли за скрит монтаж
flush mounted

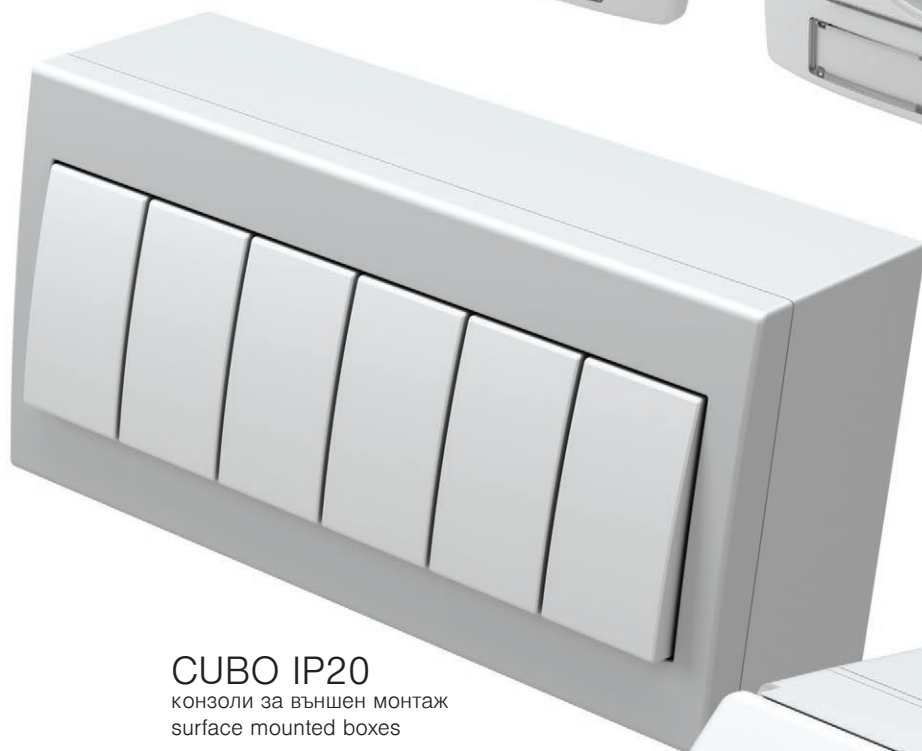

CUBO IP20
конзоли за външен монтаж
surface mounted boxes



CUBO IP55
конзоли за външен монтаж
surface mounted boxes

Трябва ви ключ или контакт за скрит, външен или подов монтаж?
Modul предоставя различни решения за монтаж с различна степен
на IP защита за системи за кабелни канали, разпределителни табла
или подови конзоли. Изборът е ваш.

Do you need switch or socket in flush, surface or floor solution?
The Modul provides different mounting solutions with different IP
protections, for trunking systems, distribution boards or floor boxes.
The choice is yours.



MA

системи за канали за кабели
trunking systems

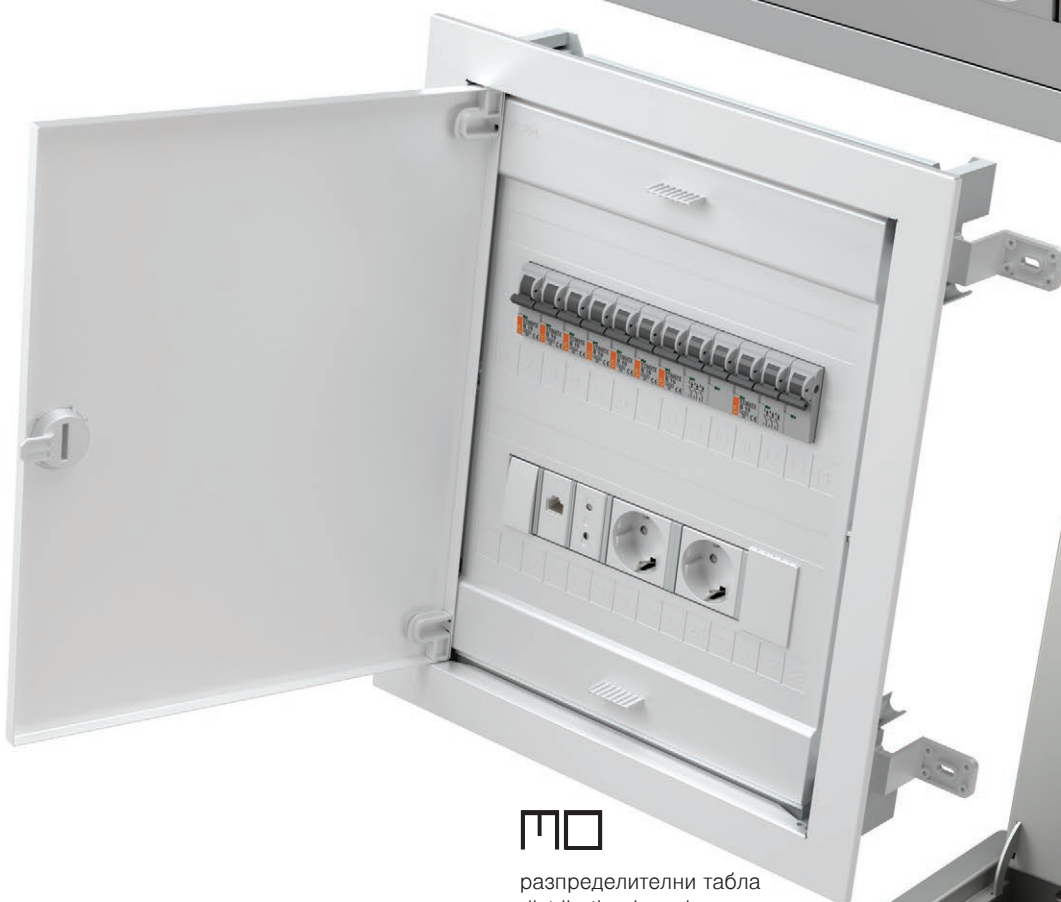

MO

разпределителни табла
distribution boards

MT

подови конзоли
floor boxes



ТЕХНИЧЕСКИ КАТАЛОГ

technical catalogue





MODUL

— функционални елементи
function elements



66

дизайн
design

PURE
line
soft



118

кутии
boxes



138

разпределение
distribution



160

ekonomik —



186

fontana —



216

TEM



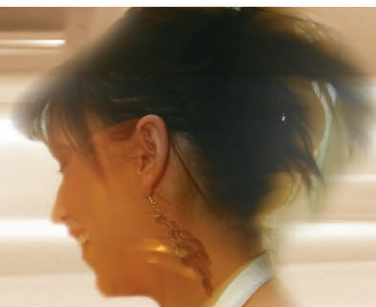

ФУНКЦИОНАЛНИ ЕЛЕМЕНТИ FUNCTION ELEMENTS

КЛЮЧОВЕ SM
SWITCHES SM



68

БУТОНИ TM
BUTTONS TM



73

ОСВЕТЛЕНИЕ IA
ILLUMINATION IA



76

КОНТАКТИ VM
SOCKETS VM



78

КОМУНИКАЦИИ KM
COMMUNICATIONS KM



82

КОМУНИКАЦИОННИ ПРИНАДЛЕЖНОСТИ KA
COMMUNICATION ACCESSORIES KA



88

ЕЛЕКТРОНИКА EM
ELECTRONICS EM



91

КОМПЛЕКТИ CM
SETS CM



110

АНТИБАКТЕРИАЛНА ПРОГРАМА AW
ANTIBACTERIAL PROGRAM AW



115

ДИЗАЙН DESIGN

ПАНЕЛИ PURE OP
COVER PLATES PURE OP



120

ПРОДУКТОВА ГАМА ПАНЕЛИ OL
COVER PLATES LINE OL



124

ПАНЕЛИ SOFT OS
COVER PLATES SOFT OS



128

МОНТАЖНИ РАМКИ NM
MOUNTING FRAMES NM



134

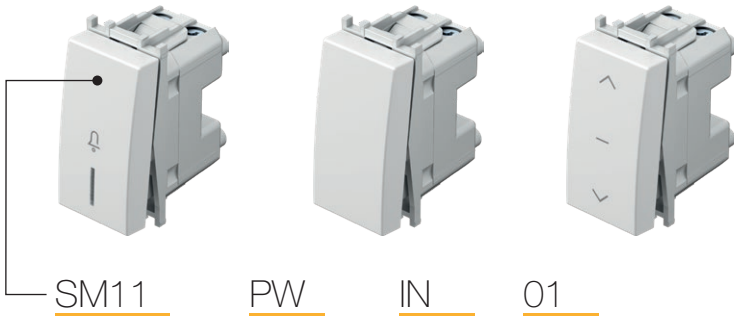

тип type	описание description	технически данни technical data	размер size	цвет colour	допълнителна информация 1 optional data 1	допълнителна информация 2 optional data 2
SM10	КЛЮЧ 1WAY SWITCH 1WAY	16AX 250V~	1M	□ PW снежнобял цвят polar white	NT неутрален neutral	🔔 O1
SM11	БУТОН 1WAY PUSH BUTTON 1WAY	16A 250V~	1M	■ SB сензорен бутон черен soft touch black	IN индикатор indicator	🔦 O2
SM12	КЛЮЧ 1WAY SWITCH 1WAY	20A 250V~	1M	■ AT антрацит anthracite		0 O3
⋮	⋮	⋮	⋮	□ ES сребрист elox silver		
⋮	⋮	⋮	⋮	■ IW слоновя кост ivory white		

КЛЮЧ 1WAY 16AX 250V~ 1M



SM10

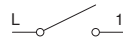

- ключ без бутон
 - 16 AX 250 V~, тип SM10
 - в съответствие с EN 60669-1
 - винтови контакти 1,5 - 2,5 mm²
- SWITCH 1WAY 16AX 250V~ 1M**
- switch without button
 - 16AX 250V~, type SM10
 - in accordance with EN 60669-1
 - screw contacts 1.5-2.5mm²

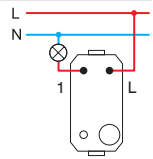

БУТОН 1WAY 16A 250V~ 1M



SM11



- бутон без клавиш за натискане
 - 16 A 250 V~, тип SM11
 - в съответствие с EN 60669-1
 - винтови контакти 1,5 - 2,5 mm²
- PUSH BUTTON 1WAY 16A 250V~ 1M**
- push button without button
 - 16A 250V~, type SM11
 - in accordance with EN 60669-1
 - screw contacts 1.5-2.5mm²

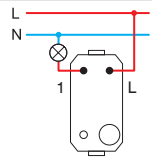

КЛЮЧ 1WAY 20A 250V~ 1M



SM12



- ключ без бутон
 - 20 A 250 V~, тип SM12
 - в съответствие с EN 60669-1
 - винтови контакти 1,5 - 2,5 mm²
- SWITCH 1WAY 20A 250V~ 1M**
- switch without button
 - 20A 250V~, type SM12
 - in accordance with EN 60669-1
 - screw contacts 1.5-2.5mm²

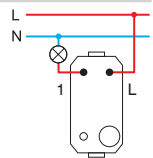

КЛЮЧ 2POLE 16AX 250V~ 1M



SM20

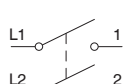

- ключ без бутон
 - 16 AX 250 V~, тип SM20
 - в съответствие с EN 60669-1
 - винтови контакти 1,5 - 2,5 mm²
 - само в комбинация с бутон TM15
- SWITCH 2POLE 16AX 250V~ 1M**
- switch without button
 - 16AX 250V~, type SM20
 - in accordance with EN 60669-1
 - screw contacts 1.5-2.5mm²
 - only in combination with button TM15

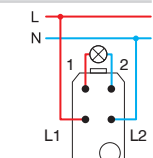



КЛЮЧ ЗА ЩОРИ 1-0-2 16AX 250V~ 1M

SM40

- ключ без бутон
- 16 AX 250 V~, тип SM40
- в съответствие с EN 60669-1
- винтови контакти 1,5 - 2,5 mm²

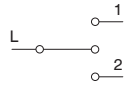

SWITCH SHUTTERS 1-0-2 16AX 250V~ 1M

- switch without button
- 16AX 250V~, type SM40
- in accordance with EN 60669-1
- screw contacts 1.5-2.5mm²

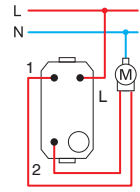

КЛЮЧ ЗА ЩОРИ 1-0-2 16A 250V~ 1M

SM41

- бутон без клавиш за натискане
- 16 A 250 V~, тип SM41
- в съответствие с EN 60669-1
- винтови контакти 1,5 - 2,5 mm²

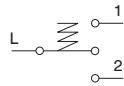

PUSH BUTTON SHUTTERS 1-0-2 16A 250V~ 1M

- push button without button
- 16A 250V~, type SM41
- in accordance with EN 60669-1
- screw contacts 1.5-2.5mm²

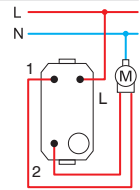

КЛЮЧ 2WAY 16AX 250V~ 1M

SM60

- ключ без бутон
- 16 AX 250 V~, тип SM60
- в съответствие с EN 60669-1
- винтови контакти 1,5 - 2,5 mm²

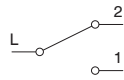

SWITCH 2WAY 16AX 250V~ 1M

- switch without button
- 16AX 250V~, type SM60
- in accordance with EN 60669-1
- screw contacts 1.5-2.5mm²

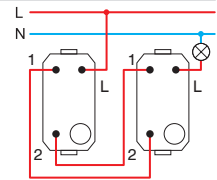

БУТОН 2WAY 16A 250V~ 1M

SM61

- бутон без клавиш за натискане
- 16 A 250 V~, тип SM61
- в съответствие с EN 60669-1
- винтови контакти 1,5 - 2,5 mm²

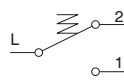

PUSH BUTTON 2WAY 16A 250V~ 1M

- push button without button
- 16A 250V~, type SM61
- in accordance with EN 60669-1
- screw contacts 1.5-2.5mm²

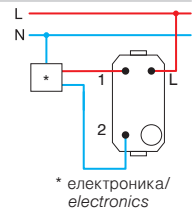

КРЪСТАТ КЛЮЧ 16AX 250V~ 1M

SM70

- ключ без бутон
- 16 AX 250 V~, тип SM70
- в съответствие с EN 60669-1
- винтови контакти 1,5 - 2,5 mm²

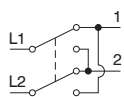

SWITCH INTERMEDIATE 16AX 250V~ 1M

- switch without button
- 16AX 250V~, type SM70
- in accordance with EN 60669-1
- screw contacts 1.5-2.5mm²

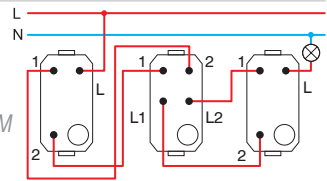

1M = 22,5 x 45
2M = 45 x 45

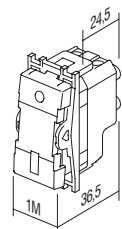
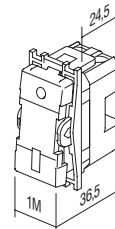



□ PW снежнобял цвят
polar white



■ SB сензорен бутон черен
soft touch black



■ AT антрацит
anthracite



□ ES сребрист
elox silver



□ IW слонова кост
ivory white

КЛЮЧ 1WAY 16AX 250V~ 1M



- SM10PW
- SM10SB
- SM10AT
- SM10ES
- SM10IW

- 16 AX 250 V~, тип SM10
- в съответствие с EN 60669-1
- винтови контакти 1,5 - 2,5 mm²
- сменяем бутон

SWITCH 1WAY 16AX 250V~ 1M
- 16AX 250V~, type SM10
- in accordance with EN 60669-1
- screw contacts 1.5-2.5 mm²
- replaceable button



КЛЮЧ 1WAY 16AX 250V~ 1M __ IN



- SM10PWIN
- SM10SBIN
- SM10ATIN
- SM10ESIN
- SM10IWIN

- IN индикатор
- 16 AX 250 V~, тип SM10
- в съответствие с EN 60669-1
- винтови контакти 1,5 - 2,5 mm²
- лампата не е включена в доставката
- сменяем бутон

SWITCH 1WAY 16AX 250V~ 1M __ IN
- IN indicator
- 16AX 250V~, type SM10
- in accordance with EN 60669-1
- screw contacts 1.5-2.5 mm²
- lamp is not included
- replaceable button



БУТОН 1WAY 16A 250V~ 1M

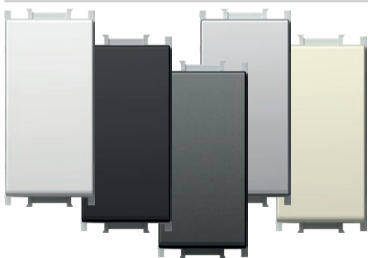

- SM11PW
- SM11SB
- SM11AT
- SM11ES
- SM11IW

- 16 A 250 V~, тип SM11
- в съответствие с EN 60669-1
- винтови контакти 1,5 - 2,5 mm²
- сменяем бутон

PUSH BUTTON 1WAY 16A 250V~ 1M
- 16A 250V~, type SM11
- in accordance with EN 60669-1
- screw contacts 1.5-2.5 mm²
- replaceable button



БУТОН 1WAY 16A 250V~ 1M __ IN 01



- SM11PWIN01
- SM11SBIN01
- SM11ATIN01
- SM11ESIN01
- SM11IWIN01

- IN 01 звънчев индикатор
- 16 A 250 V~, тип SM11
- в съответствие с EN 60669-1
- винтови контакти 1,5 - 2,5 mm²
- лампата не е включена в доставката
- сменяем бутон

PUSH BUTTON 1WAY 16A 250V~ 1M __ IN 01
- IN 01 indicator bell
- 16A 250V~, type SM11
- in accordance with EN 60669-1
- screw contacts 1.5-2.5 mm²
- lamp is not included
- replaceable button



S W I T C H E S S M

БУТОН 1WAY 16A 250V~ 1M __ IN 02



- SM11PWIN02 - IN 02 светлинен индикатор
- SM11SBIN02 - 16 A 250 V~, тип SM11
- SM11ATIN02 - в съответствие с EN 60669-1
- SM11ESIN02 - винтови контакти 1,5 - 2,5 mm²
- SM11WIN02 - лампата не е включена в доставката
- сменяем бутон

PUSH BUTTON 1WAY 16A 250V~ 1M __ IN 02

- IN 02 indicator light
- 16A 250V~, type SM11
- in accordance with EN 60669-1
- screw contacts 1.5-2.5 mm²
- lamp is not included
- replaceable button



КЛЮЧ 2POLE 16AX 250V~ 1M __ NT 03



- SM20PWNT03 - NT 03 неутрален 0-1
- SM20SBNT03 - 16 AX 250 V~, тип SM20
- SM20ATNT03 - в съответствие с EN 60669-1
- SM20ESNT03 - винтови контакти 1,5 - 2,5 mm²
- SM20IWNTO3 - сменяем бутон

SWITCH 2POLE 16AX 250V~ 1M __ NT 03

- NT 03 neutral 0-1
- 16AX 250V~, type SM20
- in accordance with EN 60669-1
- screw contacts 1.5-2.5 mm²
- replaceable button



КЛЮЧ 2POLE 16AX 250V~ 1M __ IN



- SM20PWIN - IN индикатор
- SM20SBIN - 16 AX 250 V~, тип SM20
- SM20ATIN - в съответствие с EN 60669-1
- SM20ESIN - винтови контакти 1,5 - 2,5 mm²
- SM20IWIN - лампата не е включена в доставката
- сменяем бутон

SWITCH 2POLE 16AX 250V~ 1M __ IN

- IN indicator
- 16AX 250V~, type SM20
- in accordance with EN 60669-1
- screw contacts 1.5-2.5 mm²
- lamp is not included
- replaceable button



КЛЮЧ ЗА ЩОРИ 1-0-2 16AX 250V~ 1M __ NT 10

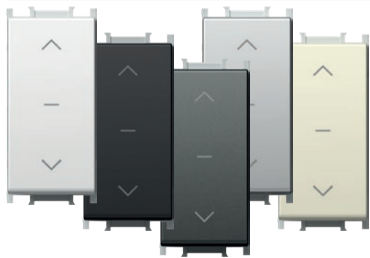

- SM40PWNT10 - NT 10 неутрален 1-0-2
- SM40SBNT10 - 16 AX 250 V~, тип SM40
- SM40ATNT10 - в съответствие с EN 60669-1
- SM40ESNT10 - винтови контакти 1,5 - 2,5 mm²
- SM40IWNTO10 - сменяем бутон

SWITCH SHUTTERS 1-0-2 16AX 250V~ 1M __ NT 10

- NT 10 neutral 1-0-2
- 16AX 250V~, type SM40
- in accordance with EN 60669-1
- screw contacts 1.5-2.5mm²
- replaceable button



БУТОНИ ЗА ЩОРИ 1-0-2 16A 250V~ 1M __ NT 10

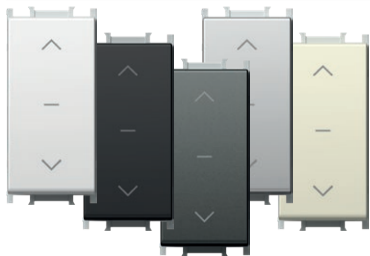

- SM41PWNT10 - NT 10 неутрален 1-0-2
- SM41SBNT10 - 16 A 250 V~, тип SM41
- SM41ATNT10 - в съответствие с EN 60669-1
- SM41ESNT10 - винтови контакти 1,5 - 2,5 mm²
- SM41IWNTO10 - сменяем бутон

PUSH BUTTON SHUTTERS 1-0-2 16A 250V~ 1M __ NT 10

- NT 10 neutral 1-0-2
- 16A 250V~, type SM41
- in accordance with EN 60669-1
- screw contacts 1.5-2.5mm²
- replaceable button



КЛЮЧ 2WAY 16AX 250V~ 1M

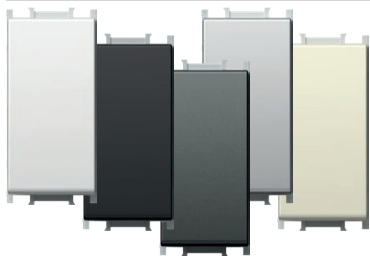

- SM60PW - 16 AX 250 V~, тип SM60
- SM60SB - в съответствие с EN 60669-1
- SM60AT - винтови контакти 1,5 - 2,5 mm²
- SM60ES - сменяем бутон
- SM60IW

SWITCH 2WAY 16AX 250V~ 1M

- 16AX 250V~, type SM60
- in accordance with EN 60669-1
- screw contacts 1.5-2.5 mm²
- replaceable button





- SM61PW
- SM61SB
- SM61AT
- SM61ES
- SM61IW

БУТОН 2WAY 16A 250V~ 1M

- 16 A 250 V~, тип SM61
- в съответствие с EN 60669-1
- винтови контакти 1,5 - 2,5 mm²
- сменяем бутон

PUSH BUTTON 2WAY 16A 250V~ 1M

- 16A 250V~, type SM61
- in accordance with EN 60669-1
- screw contacts 1.5-2.5 mm²
- replaceable button



- SM62PWCD
- SM62SBCD
- SM62ATCD
- SM62ESCD
- SM62IWCD

БУТОН С ШНУР 2WAY 16A 250V~ 1M

- CD индикатор+шнур
- дължина на шнура 1,5 m
- 16 A 250 V~, тип SM62
- в съответствие с EN 60669-1
- винтови контакти 1,5 - 2,5 mm²

PUSH BUTTON 2WAY WITH CORD 16A 250V~ 1M _ CD

- CD indicator+cord
- cord length 1.5m
- 16A 250V~, type SM62
- in accordance with EN 60669-1
- screw contacts 1.5-2.5 mm²



- SM70PW
- SM70SB
- SM70AT
- SM70ES
- SM70IW

КРЪСТАТ КЛЮЧ 16AX 250V~ 1M

- 16 AX 250 V~, тип SM70
- в съответствие с EN 60669-1
- винтови контакти 1,5 - 2,5 mm²
- сменяем бутон

SWITCH INTERMEDIATE 16AX 250V~ 1M

- 16AX 250V~, type SM70
- in accordance with EN 60669-1
- screw contacts 1.5-2.5 mm²
- replaceable button





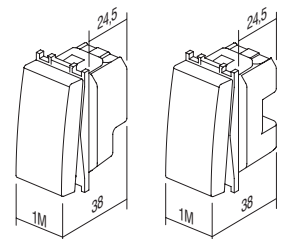



1M = 22,5 x 45
2M = 45 x 45



B U T T O N S T M



тип type	описание description	размер size	цвет colour	допълнителна информация 1 optional data 1	допълнителна информация 2 optional data 2
TM11	БУТОН BUTTON	1M	<input type="checkbox"/> PW снежнобял цвят polar white	 NT неутрален neutral	 01
TM12	БУТОН BUTTON	2M	<input checked="" type="checkbox"/> SB сензорен бутон черен soft touch black	 IN индикатор indicator	 02
TM21	КАПАЧЕ BLANK	1M	<input checked="" type="checkbox"/> AT антрацит anthracite		 03
:	:	:	<input type="checkbox"/> ES сребрист elox silver		
:	:	:	<input type="checkbox"/> IW слонова кост ivory white		

БУТОН 1M

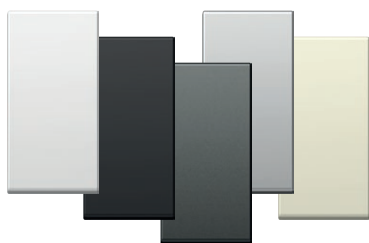

- TM11PW
- TM11SB
- TM11AT
- TM11ES
- TM11IW

- сменяем бутон 1M
- в съответствие с EN 60669-1
BUTTON 1M
- replaceable button 1M
- in accordance with EN 60669-1



БУТОН 1M С ИНДИКАТОР



- TM11PWIN
- TM11SBIN
- TM11ATIN
- TM11ESIN
- TM11IWIN

- сменяем бутон 1M
- в съответствие с EN 60669-1
BUTTON 1M INDICATOR
- replaceable button 1M
- in accordance with EN 60669-1



БУТОН 2M

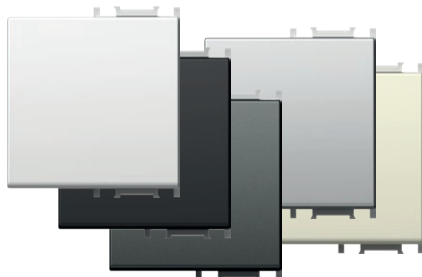

- TM12PW
- TM12SB
- TM12AT
- TM12ES
- TM12IW

- сменяем бутон 2M с носач за бутон
- за надграждане на ключ или бутон от размер 1M към размер 2M
- в съответствие с EN 60669-1
BUTTON 2M
- replaceable button 2M with button carrier
- to upgrade switch or push button from size 1M to size 2M
- in accordance with EN 60669-1

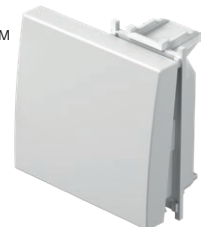

БУТОН 2M С ИНДИКАТОР

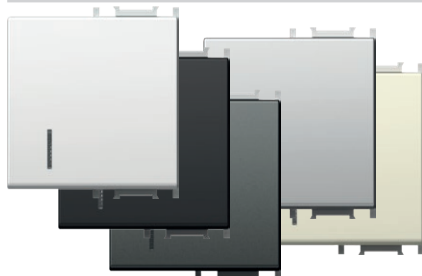

- TM12PWIN
- TM12SBIN
- TM12ATIN
- TM12ESIN
- TM12IWIN

- сменяем бутон 2M с носач за бутон
- за надграждане на ключ или бутон от размер 1M към размер 2M
- в съответствие с EN 60669-1
BUTTON 2M INDICATOR
- replaceable button 2M with button carrier
- to upgrade switch or push button from size 1M to size 2M
- in accordance with EN 60669-1



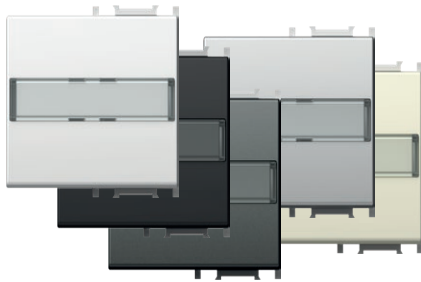

- TM13PWIL
- TM13SBIL
- TM13ATIL
- TM13ESIL
- TM13IWIL

БУТОН 2М С ПАНЕЛ С НАДПИС

- сменяем бутон 2М с носач за бутон
- за надграждане на ключ или бутон
- от размер 1М към размер 2М
- в съответствие с EN 60669-1

BUTTON 2M WITH INSCRIPTION PLATE

- replaceable button 2M with button carrier
- to upgrade switch or push button
- from size 1M to size 2M
- in accordance with EN 60669-1



- TM15PW
- TM15SB
- TM15AT
- TM15ES
- TM15IW

БУТОН 1М 2POLE

- сменяем бутон 1М
- само в комбинация с механизъм SM20
- в съответствие с EN 60669-1

BUTTON 1M 2POLE

- replaceable button 1M
- only in combination with mechanism SM20
- in accordance with EN 60669-1

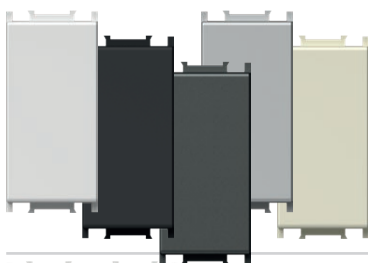

- TM21PW
- TM21SB
- TM21AT
- TM21ES
- TM21IW

КАПАЧЕ 1М

- модулно капаче за покриване на неизползвани позиции
- в съответствие с EN 60669-1

BLANK 1M

- blank modul to fill up empty spaces
- in accordance with EN 60669-1

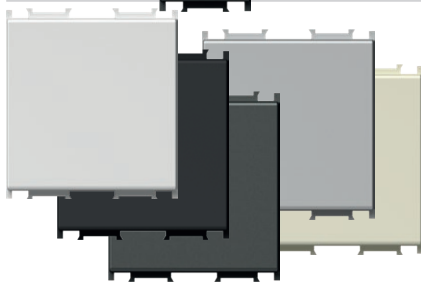

- TM22PW
- TM22SB
- TM22AT
- TM22ES
- TM22IW

КАПАЧЕ 2М

- модулно капаче за покриване на неизползвани позиции
- в съответствие с EN 60669-1

BLANK 2M

- blank modul to fill up empty spaces
- in accordance with EN 60669-1

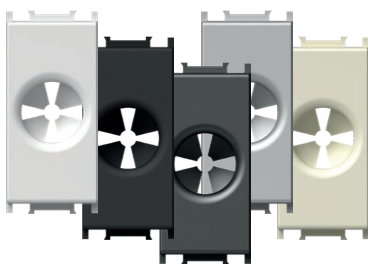

- TM31PW
- TM31SB
- TM31AT
- TM31ES
- TM31IW

ИЗХОД ЗА КАБЕЛ 1М

- отвор за изход на кабел
- в съответствие с EN-60669-1

CABLE OUTLET 1M

- outlet for cable
- in accordance with EN-60669-1



1M = 22,5 x 45
2M = 45 x 45

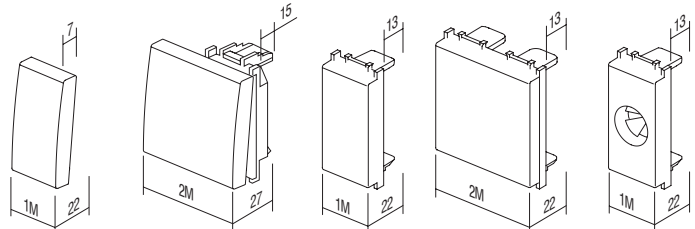

TM11
TM15

TM12
TM13

TM21

TM22

TM31

B U T T O N S T M

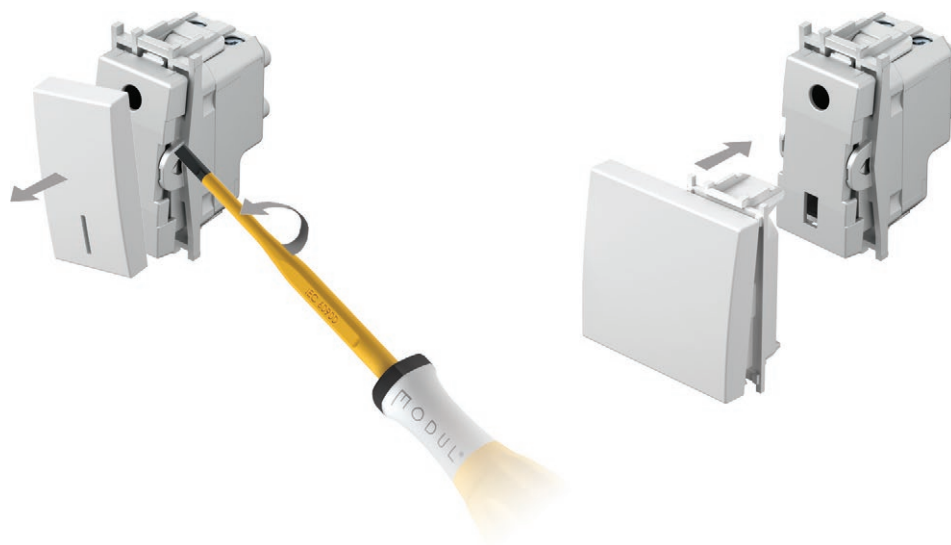

ЛАЗЕРЕН ПЕЧАТ ВЪРХУ БУТОНИ

- лазерно отпечатване на всякакви графични изображения върху маркирани места
 - налични стандартни символи, други – по заявка
- LASER PRINT ON BUTTONS**
- laser print of any graphics on marked locations
 - standard symbols from stock, other on request

1M

A
B
C

2M

A	D	G
B	E	H
C	F	I

СИМВОЛИ

SYMBOLS

01	02	03	04	05	06	07	08	09	10	11	12	20	21	22	23
24	25	26	27	28	29	30	31	32	33	34	35	36	37	38	39
40	41	42	43	44	45	46	47	48							

СТАНДАРТНИ СИМВОЛИ

STANDARD SYMBOLS

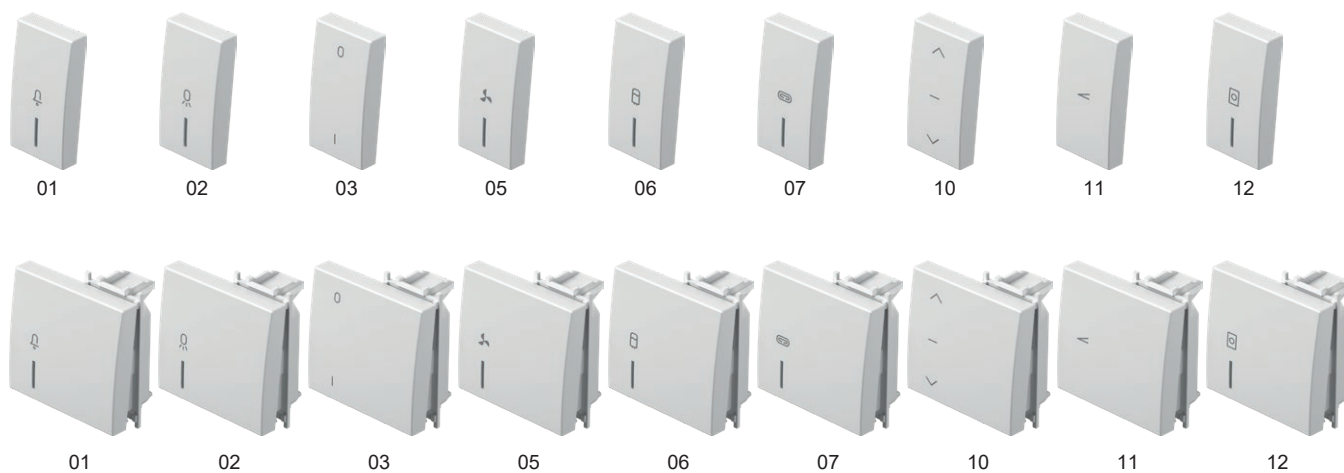

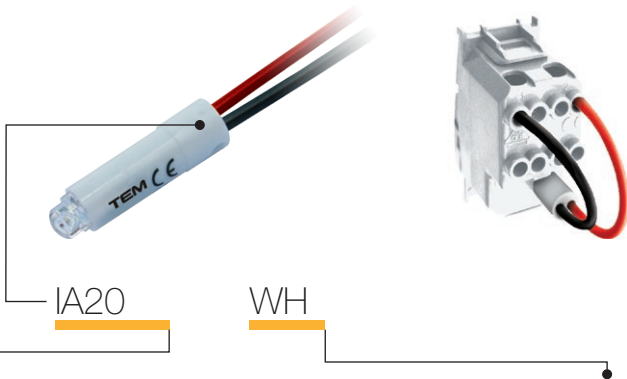

тип type	описание description	технически данни technical data	цвет colour
IA10	НЕОНОВА ЛАМПА NEON LAMP	230V~ 0,34W	□ WH бял цвят white
IA20	СВЕТОДИОДНА ЛАМПА LED LAMP	230V~ AC/DC 0,40W	■ BL син цвят blue
IA21	СВЕТОДИОДНА ЛАМПА LED LAMP	24V AC/DC 0,20W	■ RD червен red
·	·	·	■ GR зелен green
·	·	·	■ OR оранжев orange

НЕОНОВА ЛАМПА 230 V~ 0,34 W

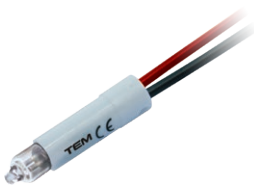

■ IA10OR

- за индикация, осветление или постоянно осветяване на ключа
- в комбинация с бутон с индикатор

NEON LAMP 230V~ 0,34W

- for indication, illumination or constant illumination of switch
- in combination with button with indicator

СВЕТОДИОДНА ЛАМПА 230 V AC/DC 0,40 W



- IA20WH
- IA20GR
- IA20RD
- IA20BL

- за индикация, осветление или постоянно осветяване на ключа
- в комбинация с бутон с индикатор

LED LAMP 230V AC/DC 0,40W

- for indication, illumination or constant illumination of switch
- in combination with button with indicator

СВЕТОДИОДНА ЛАМПА 24 V AC/DC 0,20 W



- IA21WH
- IA21RD

- за индикация, осветление или постоянно осветяване на ключа
- в комбинация с бутон с индикатор

LED LAMP 24V AC/DC 0,20W

- for indication, illumination or constant illumination of switch
- in combination with button with indicator

СВЕТОДИОДНА ЛАМПА 12 V AC/DC 0,10 W



- IA22WH
- IA22RD

- за индикация, осветление или постоянно осветяване на ключа
- в комбинация с бутон с индикатор

LED LAMP 12V AC/DC 0,10W

- for indication, illumination or constant illumination of switch
- in combination with button with indicator

RC ВЕРИГА 250 V~

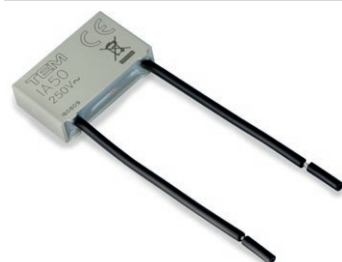

IA50

- RC верига за отстраняване на смущенията при работата на LED лампи
- възможно е успоредно свързване на няколко RC вериги с лампи
- 0,1 μF, 100 Ω, 250 V~

RC CIRCUIT 250V~

- RC circuit to eliminate disturbances in the operation of LED lamps
- parallel connections of more RC circuits with lamps are possible
- 0,1 μF, 100 Ω, 250V~

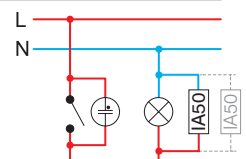

индикация /
Indication

* освещение /
Illumination

Постоянно освещение /
Constant illumination

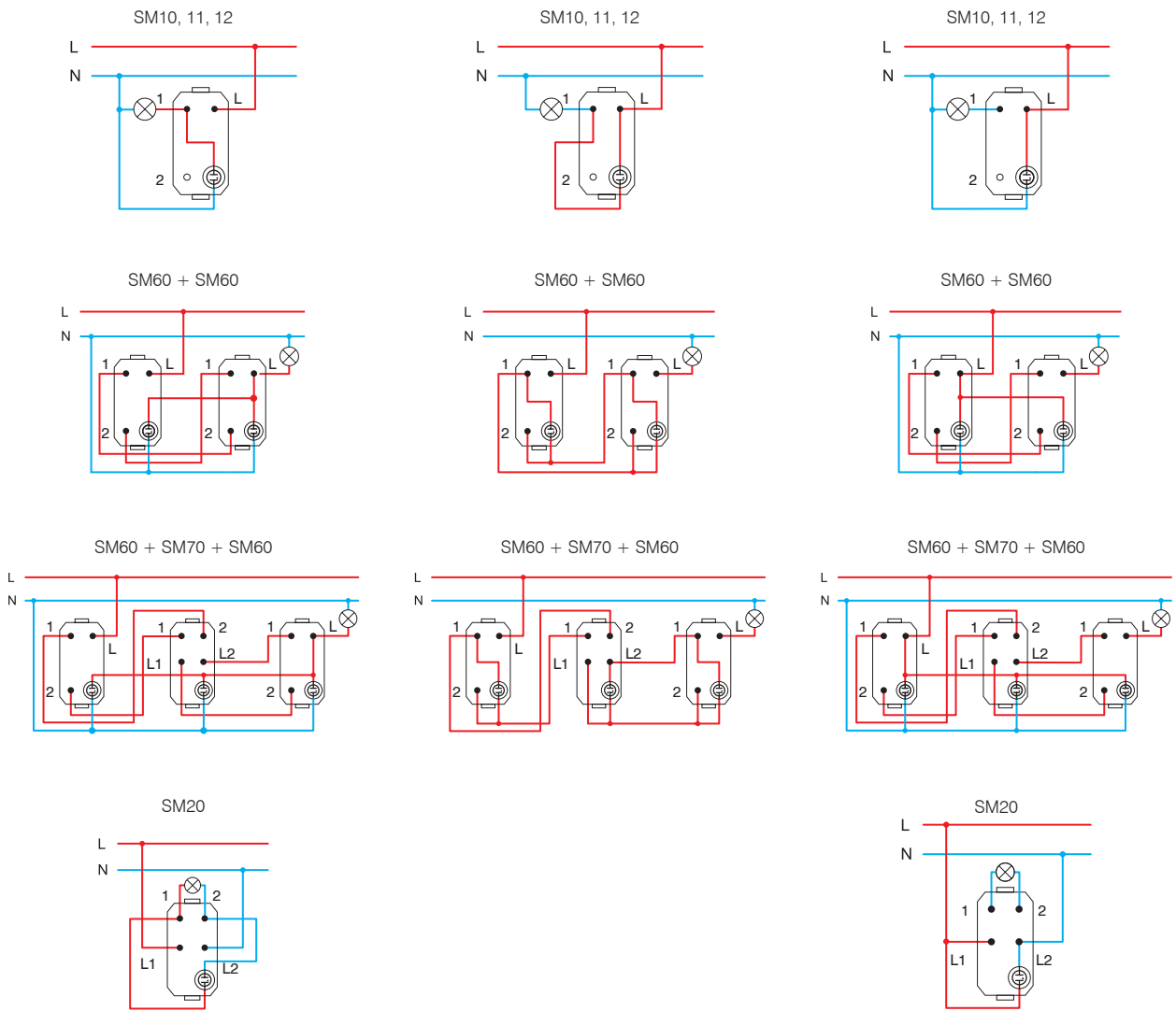

* връзките не са подходящи за енергоспестяващи крушки (CFL, LED) /
the connections are not suitable for energy-saving bulbs (CFL, LED)

1M = 22,5 x 45
2M = 45 x 45

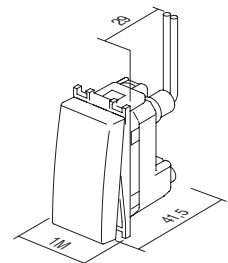

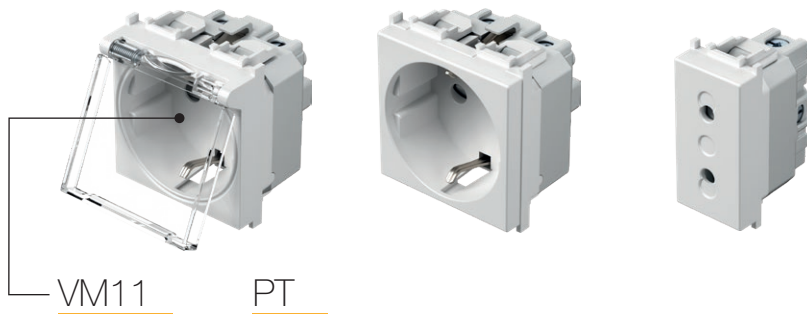

тип type	описание description	технически данни technical data	размер size	цвет colour																																				
VM10	КОНТАКТ ШУКО+KS SOCKET SCHUKO+KS	2P+E 16A 250V~	2M	<table border="0"> <tr> <td><input type="checkbox"/> PW</td> <td>снежнобял polar white</td> <td><input type="checkbox"/> PT</td> <td>бял + прозрачен white+transparent</td> <td><input type="checkbox"/> PP</td> <td>бял+бял white+white</td> </tr> </table>	<input type="checkbox"/> PW	снежнобял polar white	<input type="checkbox"/> PT	бял + прозрачен white+transparent	<input type="checkbox"/> PP	бял+бял white+white																														
<input type="checkbox"/> PW	снежнобял polar white	<input type="checkbox"/> PT	бял + прозрачен white+transparent	<input type="checkbox"/> PP	бял+бял white+white																																			
VM11	КОНТАКТ ШУКО+KS+КАПАК SOCKET SCHUKO+KS+COVER	2P+E 16A 250V~	2M	<table border="0"> <tr> <td><input checked="" type="checkbox"/> SB</td> <td>черен soft touch black</td> <td><input checked="" type="checkbox"/> BT</td> <td>черен + прозрачен soft touch black+transparent</td> <td><input checked="" type="checkbox"/> BB</td> <td>черен+черен soft touch black+black</td> </tr> </table>	<input checked="" type="checkbox"/> SB	черен soft touch black	<input checked="" type="checkbox"/> BT	черен + прозрачен soft touch black+transparent	<input checked="" type="checkbox"/> BB	черен+черен soft touch black+black																														
<input checked="" type="checkbox"/> SB	черен soft touch black	<input checked="" type="checkbox"/> BT	черен + прозрачен soft touch black+transparent	<input checked="" type="checkbox"/> BB	черен+черен soft touch black+black																																			
VM20	КОНТАКТ EURO+KS SOCKET EURO+KS	2P 10A 250V~	1M	<table border="0"> <tr> <td><input checked="" type="checkbox"/> AT</td> <td>антрацит anthracite</td> <td><input checked="" type="checkbox"/> AT</td> <td>антрацит + прозрачен anthracite+transparent</td> <td><input checked="" type="checkbox"/> AA</td> <td>антрацит+прозрачен anthracite+anthracite</td> </tr> <tr> <td><input checked="" type="checkbox"/> ES</td> <td>сребрист elox silver</td> <td><input checked="" type="checkbox"/> ST</td> <td>сребрист + прозрачен silver+transparent</td> <td><input checked="" type="checkbox"/> SS</td> <td>сребрист+сребрист silver+silver</td> </tr> <tr> <td><input checked="" type="checkbox"/> IW</td> <td>слонова кост ivory white</td> <td><input checked="" type="checkbox"/> IT</td> <td>слонова кост + прозрачен ivory+transparent</td> <td><input checked="" type="checkbox"/> II</td> <td>слонова кост+слонова кост ivory+ivory</td> </tr> <tr> <td><input checked="" type="checkbox"/> RD</td> <td>червен red</td> <td><input checked="" type="checkbox"/> RT</td> <td>червен + прозрачен red+transparent</td> <td><input checked="" type="checkbox"/> RR</td> <td>червен+червен red+red</td> </tr> <tr> <td><input checked="" type="checkbox"/> GR</td> <td>зелен green</td> <td><input checked="" type="checkbox"/> GT</td> <td>зелен + прозрачен green+transparent</td> <td><input checked="" type="checkbox"/> GG</td> <td>зелен+зелен green+green</td> </tr> <tr> <td><input checked="" type="checkbox"/> OR</td> <td>оранжев orange</td> <td><input checked="" type="checkbox"/> OT</td> <td>оранжев + прозрачен orange+transparent</td> <td><input checked="" type="checkbox"/> OO</td> <td>оранжев+оранжев orange+orange</td> </tr> </table>	<input checked="" type="checkbox"/> AT	антрацит anthracite	<input checked="" type="checkbox"/> AT	антрацит + прозрачен anthracite+transparent	<input checked="" type="checkbox"/> AA	антрацит+прозрачен anthracite+anthracite	<input checked="" type="checkbox"/> ES	сребрист elox silver	<input checked="" type="checkbox"/> ST	сребрист + прозрачен silver+transparent	<input checked="" type="checkbox"/> SS	сребрист+сребрист silver+silver	<input checked="" type="checkbox"/> IW	слонова кост ivory white	<input checked="" type="checkbox"/> IT	слонова кост + прозрачен ivory+transparent	<input checked="" type="checkbox"/> II	слонова кост+слонова кост ivory+ivory	<input checked="" type="checkbox"/> RD	червен red	<input checked="" type="checkbox"/> RT	червен + прозрачен red+transparent	<input checked="" type="checkbox"/> RR	червен+червен red+red	<input checked="" type="checkbox"/> GR	зелен green	<input checked="" type="checkbox"/> GT	зелен + прозрачен green+transparent	<input checked="" type="checkbox"/> GG	зелен+зелен green+green	<input checked="" type="checkbox"/> OR	оранжев orange	<input checked="" type="checkbox"/> OT	оранжев + прозрачен orange+transparent	<input checked="" type="checkbox"/> OO	оранжев+оранжев orange+orange
<input checked="" type="checkbox"/> AT	антрацит anthracite	<input checked="" type="checkbox"/> AT	антрацит + прозрачен anthracite+transparent	<input checked="" type="checkbox"/> AA	антрацит+прозрачен anthracite+anthracite																																			
<input checked="" type="checkbox"/> ES	сребрист elox silver	<input checked="" type="checkbox"/> ST	сребрист + прозрачен silver+transparent	<input checked="" type="checkbox"/> SS	сребрист+сребрист silver+silver																																			
<input checked="" type="checkbox"/> IW	слонова кост ivory white	<input checked="" type="checkbox"/> IT	слонова кост + прозрачен ivory+transparent	<input checked="" type="checkbox"/> II	слонова кост+слонова кост ivory+ivory																																			
<input checked="" type="checkbox"/> RD	червен red	<input checked="" type="checkbox"/> RT	червен + прозрачен red+transparent	<input checked="" type="checkbox"/> RR	червен+червен red+red																																			
<input checked="" type="checkbox"/> GR	зелен green	<input checked="" type="checkbox"/> GT	зелен + прозрачен green+transparent	<input checked="" type="checkbox"/> GG	зелен+зелен green+green																																			
<input checked="" type="checkbox"/> OR	оранжев orange	<input checked="" type="checkbox"/> OT	оранжев + прозрачен orange+transparent	<input checked="" type="checkbox"/> OO	оранжев+оранжев orange+orange																																			



КОНТАКТ ШУКО+KS 2P+E 16 A 250 V~ 2M

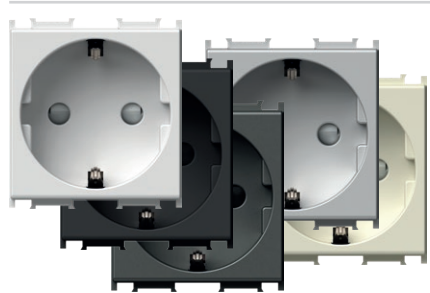

- VM10PW
- VM10SB
- VM10AT
- VM10ES
- VM10IW

- 2P+E шуко
- 16 A 250 V~, тип VM10
- в съответствие с IEC 60884-1, CEE7
- винтови контакти 1,5 - 2,5 mm²
- Вградена защита от допир на контакти



SOCKET SCHUKO+KS 2P+E 16A 250V~ 2M

- 2P+E schuko
- 16A 250V~, type VM10
- in accordance with IEC 60884-1, CEE7
- screw contacts 1.5-2.5 mm²
- shuttered live contacts

КОНТАКТ ШУКО+KS 2P+E 16 A 250 V~ 2M

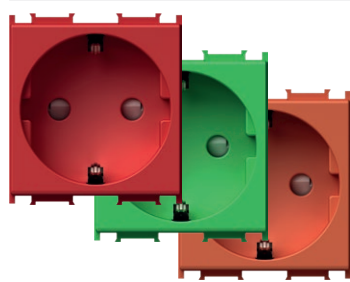

- VM10RD
- VM10GR
- VM10OR

- 2P+E шуко, 16 A 250 V~, тип VM10
- в съответствие с IEC 60884-1, CEE7
- винтови контакти 1,5 - 2,5 mm²
- Вградена защита от допир на контакти



SOCKET SCHUKO+KS 2P+E 16A 250V~ 2M

- 2P+E schuko
- 16A 250V~, type VM10
- in accordance with IEC 60884-1, CEE7
- screw contacts 1.5-2.5 mm²
- shuttered live contacts

КОНТАКТ ШУКО+KS+КАПАК 2P+E 16A 250V~ 2M

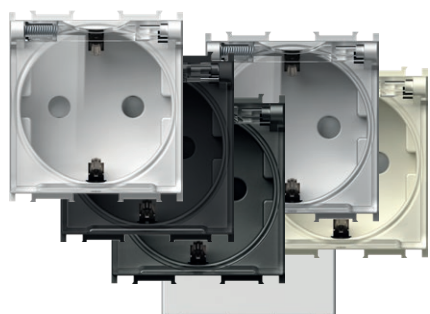

- VM11PT
- VM11BT
- VM11AT
- VM11ST
- VM11IT
- VM11PP

- 2P+E шуко+капак, 16A 250V~, тип VM11
- в съответствие с IEC 60884-1, CEE7
- винтови контакти 1,5 - 2,5 mm²
- Вградена защита от допир на контакти



SOCKET SCHUKO+KS+COVER

2P+E 16A 250V~ 2M
- 2P+E schuko+cover
- 16A 250V~, type VM11
- in accordance with IEC 60884-1, CEE7
- screw contacts 1.5-2.5 mm²
- shuttered live contacts

КОНТАКТ EURO+KS 2P 10 A 250 V~ 1M

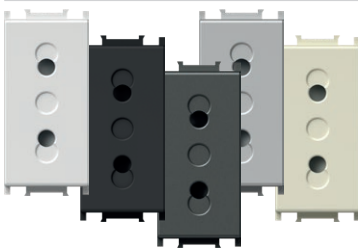

- VM20PW
- VM20SB
- VM20AT
- VM20ES
- VM20IW

- 2P Euro, 10 A 250 V~, тип VM20
- в съответствие с IEC 60884-1, CEE7
- винтови контакти 1,5 - 2,5 mm²
- Вградена защита от допир на контакти



SOCKET EURO+KS 2P 10A 250V~ 1M

- 2P Euro
- 10A 250V~, type VM20
- in accordance with IEC 60884-1, CEE7
- screw contacts 1.5-2.5 mm²
- shuttered live contacts

ФРЕНСКИ КОНТАКТ +KS 2P+E 16 A 250 V~ 2M

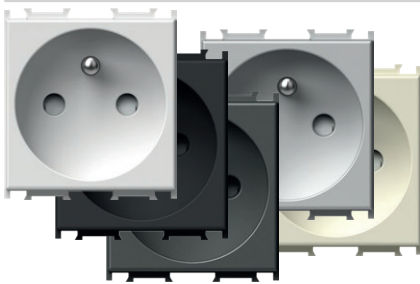

- VM40PW
- VM40SB
- VM40AT
- VM40ES
- VM40IW

- 2P+E френски контакт, 16 A 250 V~, тип VM40
- в съответствие с IEC 60884-1, NF C 61-314, CEE7
- винтови контакти 1,5 - 2,5 mm²
- Вградена защита от допир на контакти



SOCKET FRENCH+KS 2P+E 16A 250V~ 2M

- 2P+E French
- 16A 250V~, type VM40
- in accordance with IEC 60884-1, NF C 61-314, CEE7
- screw contacts 1.5-2.5 mm²
- shuttered live contacts

ФРЕНСКИ КОНТАКТ +KS 2P+E 16 A 250 V~ 2M

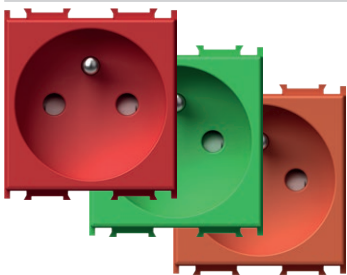

- VM40RD
- VM40GR
- VM40OR

- 2P+E френски контакт, 16 A 250 V~, тип VM40
- в съответствие с IEC 60884-1, NF C 61-314, CEE7
- винтови контакти 1,5 - 2,5 mm²
- Вградена защита от допир на контакти

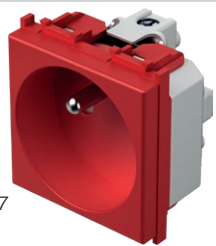

SOCKET FRENCH+KS 2P+E 16A 250V~ 2M

- 2P+E French
- 16A 250V~, type VM40
- in accordance with IEC 60884-1, NF C 61-314, CEE7
- screw contacts 1.5-2.5 mm²
- shuttered live contacts

ФРЕНСКИ КОНТАКТ+KS+КАПАК 2P+E 16A 250V~ 2M



- VM41PT
- VM41BT
- VM41AT
- VM41ST
- VM41IT

- 2P+E френски контакт+капак, 16A 250V~, тип VM41
- в съответствие с IEC 60884-1, NF C 61-314, CEE7
- винтови контакти 1,5 - 2,5 mm²
- Вградена защита от допир на контакти



SOCKET FRENCH+KS+COVER

- 2P+E 16A 250V~ 2M
- 2P+E French+cover
- 16A 250V~, type VM41
- in accordance with IEC 60884-1, NF C 61-314, CEE7
- screw contacts 1.5-2.5 mm²
- shuttered live contacts

ИТАЛИАНСКИ КОНТАКТ P17/11+KS 2P+E 16 A 250 V~ 1M

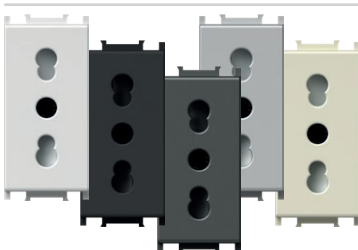

- VM30PW
- VM30SB
- VM30AT
- VM30ES
- VM30IW

- 2P+E Италиански контакт P17/11, 16 A 250 V~, тип VM30
- в съответствие с IEC 60884-1, CEI 23-50
- винтови контакти 1,5 - 2,5 mm²
- Вградена защита от допир на контакти



SOCKET ITALIAN P17/11+KS 2P+E 16A 250V~ 1M

- 2P+E Italian P17/11
- 16A 250V~, type VM30
- in accordance with IEC 60884-1, CEI 23-50
- screw contacts 1.5-2.5 mm²
- shuttered live contacts

КОНТАКТ SCHUKO/ITA P17/11+KS 2P+E 16A 250V~ 2M

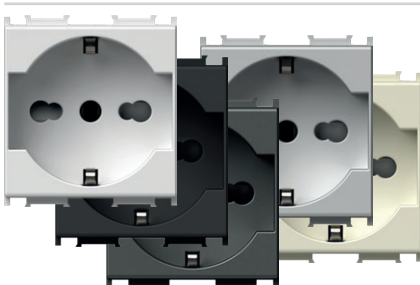

- VM31PW
- VM31SB
- VM31AT
- VM31ES
- VM31IW

- 2P+E/контакт шуко/италиански P17/11, 16A 250V~, тип VM31
- в съответствие с IEC 60884-1, CEI 23-50
- винтови контакти 1,5 - 2,5 mm²
- Вградена защита от допир на контакти

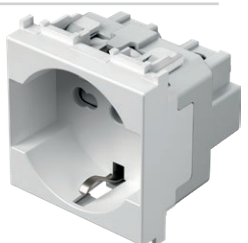

SOCKET SCHUKO/ITA P17/11+KS

- 2P+E 16A 250V~ 2M
- 2P+E schuko/Italian P17/11
- 16A 250V~, type VM31
- in accordance with IEC 60884-1, CEI 23-50
- screw contacts 1.5-2.5 mm²
- shuttered live contacts

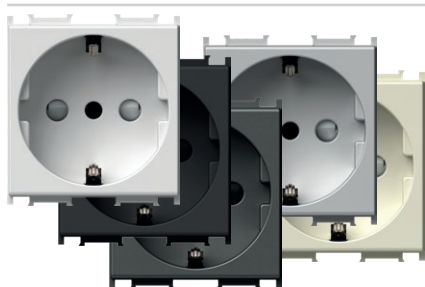

- VM32PW
- VM32SB
- VM32AT
- VM32ES
- VM32IW

КОНТАКТ ШУКО/ИТА P30+KS 2P+E 16A 250V~ 2M

- 2P+E/контакт шуко/италиански P30, 16A 250V~, тип VM32
- в съответствие с IEC 60884-1, CEI 23-50
- винтови контакти 1,5 - 2,5 mm²
- Вградена защита от допир на контакти



SOCKET SCHUKO/ITA P30+KS 2P+E 16A 250V~ 2M

- 2P+E schuko/Italian P30
- 16A 250V~, type VM32
- in accordance with IEC 60884-1, CEI 23-50
- screw contacts 1.5-2.5 mm²
- shuttered live contacts

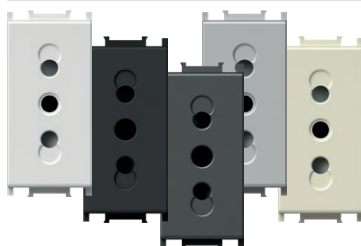

- VM33PW
- VM33SB
- VM33AT
- VM33ES
- VM33IW

ИТАЛИАНСКИ КОНТАКТ P11+KS 2P+E 10 A 250 V~ 1M

- 2P+E Италиански контакт P11, 10 A 250 V~, тип VM33
- в съответствие с IEC 60884-1, CEI 23-50
- винтови контакти 1,5 - 2,5 mm²
- Вградена защита от допир на контакти



SOCKET ITALIAN P11+KS 2P+E 10A 250V~ 1M

- 2P+E Italian P11
- 10A 250V~, type VM33
- in accordance with IEC 60884-1, CEI 23-50
- screw contacts 1.5-2.5 mm²
- shuttered live contacts

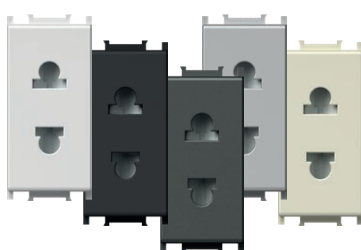

- VM21PW
- VM21SB
- VM21AT
- VM21ES
- VM21IW

КОНТАКТ EURO/АМЕРИКАНСКИ+KS 2P 16 A 250 V~ 1M

- 2P Euro/американски, 16 A 250 V~, тип VM21
- винтови контакти 1,5 - 2,5 mm²
- Вградена защита от допир на контакти
- само за страни, които не са членки в ЕС



SOCKET EURO/AMERICAN+KS 2P 16A 250V~ 1M

- 2P Euro/American
- 16A 250V~, type VM21
- screw contacts 1.5-2.5 mm²
- shuttered live contacts
- only for countries not members of EU

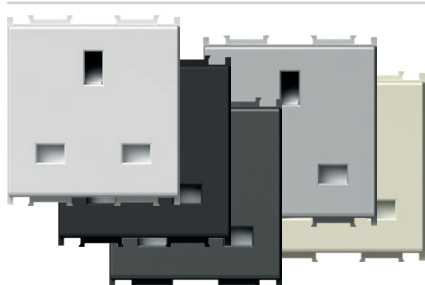

- VM52PW
- VM52SB
- VM52AT
- VM52ES
- VM52IW

БРИТАНСКИ КОНТАКТ BS 1363-2+KS 2P+E 13 A 250 V~ 2M

- 2P+E британски контакт BS 1363-2, 13 A 250 V~, тип VM52
- в съответствие с BS 1363-2
- винтови контакти 1,5 - 4 mm²
- Вградена защита от допир на контакти



SOCKET BRITISH BS 1363-2+KS 2P+E 13A 250V~ 2M

- 2P+E British BS 1363-2
- 13A 250V~, type VM52
- in accordance with BS 1363-2
- screw contacts 1.5-4 mm²
- shuttered live contacts



VM80

УСТРОЙСТВО ЗА ЗАЩИТА СРЕЩУ ОТСКОЦИ НА НАПРЕЖЕНИЕТО MPE MINI 275 V/50 Hz

- успоредно свързване с първия контакт в реда
- клас на защита III
- U_c=275Vac, U_{oc}/I_{sc}=6kV/3kA, U_p<800V
- в съответствие с IEC 61643-1
- проводници 1,5 mm², IP20
- звуков сигнал при прекъсване





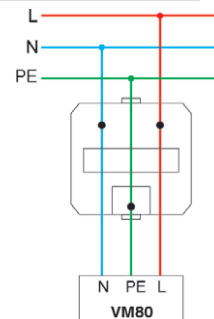





SURGE PROTECTOR MPE MINI 275V/50Hz

- parallel connection with the first socket in the row
- protection class III
- U_c=275Vac, U_{oc}/I_{sc}=6kV/3kA, U_p<800V
- in accordance with IEC 61643-1
- wires 1.5mm², IP20
- sound signal at breakdown





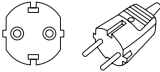
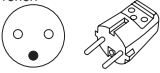

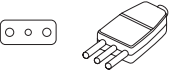
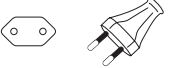
S O C K E T S V M

СЪОТВЕТВИЕ НА КОНТАКТИ И ЩЕПСЕЛИ
SOCKETS AND PLUGS MATCHING

КОНТАКТ / SOCKET								
ТИП НА ЩЕПСЕЛА / PLUG STYLE	VM10 VM11	VM20	VM30	VM33	VM31	VM32	VM40 VM41	VM21
Немски / German 	•				•	•		
Френски / French 	•				•	•	•	
Италиански / Italian S11 			•	•	•	•		
Италиански / Italian S17 			•	•	•			
euro 	•	•	•		•	•	•	•

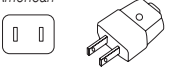
СЪОТВЕТВИЕ НА КОНТАКТИ И ЩЕПСЕЛИ
SOCKETS AND PLUGS MATCHING

КОНТАКТ / SOCKET		
ТИП НА ЩЕПСЕЛА / PLUG STYLE	VM21	VM52
Американски / American 	•	
Британски / British BS 1363-2 		•

1M = 22,5 x 45
2M = 45 x 45

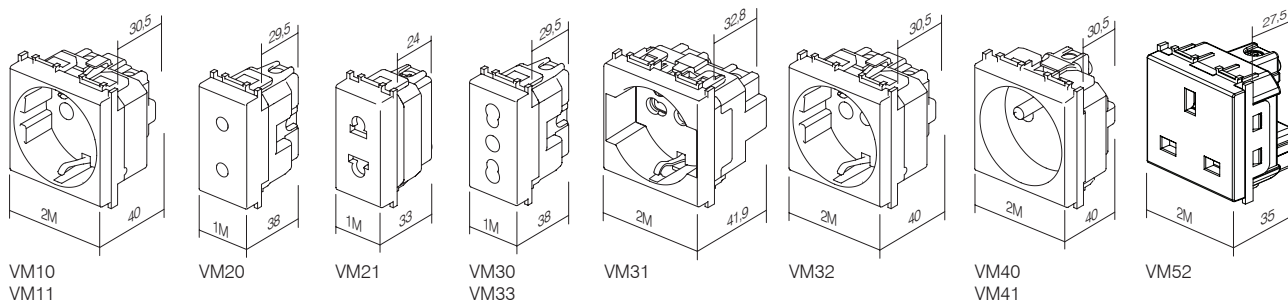



тип type	описание description	технически данни technical data	размер size	цвет colour
KM10	КОНЕКТОР ЗА ТВ ОСНОВЕН SOCKET TV BASIC	0dB	1M	<input type="checkbox"/> PW снежнобял цвят polar white
KM11	КОНЕКТОР ЗА ТВ КРАЕН SOCKET TV END-LINE	1dB	1M	<input checked="" type="checkbox"/> SB сензорен бутон черен soft touch black
KM12	КОНЕКТОР ЗА ТВ ПРЕХОДЕН SOCKET TV TROUGHPASS	10dB	1M	<input checked="" type="checkbox"/> AT антрацит anthracite
⋮	⋮	⋮	⋮	<input type="checkbox"/> ES сребрист elox silver
⋮	⋮	⋮	⋮	<input type="checkbox"/> IW слонова кост ivory white

КОНЕКТОР ЗА ТВ ОСНОВЕН 0 dB 1M



- KM10PW
- KM10SB
- KM10AT
- KM10ES
- KM10IW

- контакт за ТВ базов
- затихване 0 dB
- заден конектор – стандарт F
SOCKET TV BASIC 0dB 1M
- TV basic
- reduction 0dB
- back connector – F standard



КОНЕКТОР ЗА ТВ ОСНОВЕН 0 dB 2M

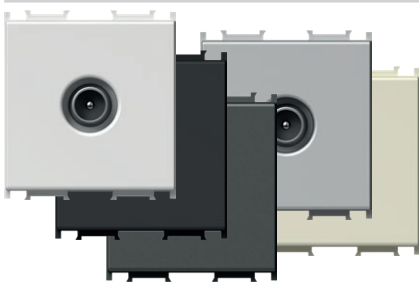

- KM20PW
- KM20SB
- KM20AT
- KM20ES
- KM20IW

- контакт за ТВ базов
- затихване 0 dB
- заден конектор – стандарт F
SOCKET TV BASIC 0dB 2M
- TV basic
- reduction 0dB
- back connector – F standard



КОНЕКТОР ЗА ТВ КРАЕН 1 dB 1M



- KM11PW
- KM11SB
- KM11AT
- KM11ES
- KM11IW

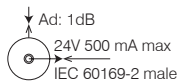

- контакт за ТВ краен
- честотен обхват 5÷2400 MHz
- затихване < 1 dB
- в съответствие с EN 50083-1
- винтови контакти
SOCKET TV END-LINE 1dB 1M
- TV end-line
- frequency range 5÷2400 MHz
- reduction < 1 dB
- in accordance with EN 50083-1
- screw contacts



КОНЕКТОР ЗА ТВ ПРЕХОДЕН 10 dB 1M



- KM12PW
- KM12SB
- KM12AT
- KM12ES
- KM12IW

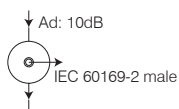

- преходник за ТВ сигнал
- честотен обхват 5÷2400 MHz
- затихване < 10 dB
- в съответствие с EN 50083-1
- винтови контакти
SOCKET TV TROUGHPASS 10dB 1M
- TV troughpass
- frequency range 5÷2400 MHz
- reduction < 10 dB
- in accordance with EN 50083-1
- screw contacts



КОНЕКТОР ЗА САТЕЛИТНА ТВ БАЗОВ 0 dB 1M



- KM15PW
- KM15SB
- KM15AT
- KM15ES
- KM15IW

- контакт за сателитна ТВ базов
 - затихване 0 dB
 - заден конектор – стандарт F
SOCKET SAT BASIC 0dB 1M
 - SAT basic
 - reduction 0dB
 - back connector – F standard



КОНЕКТОР ЗА САТЕЛИТНА ТВ БАЗОВ 0 dB 2M

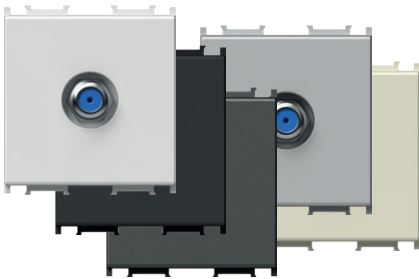

- KM24PW
- KM24SB
- KM24AT
- KM24ES
- KM24IW

- контакт за сателитна ТВ базов
 - затихване 0 dB
 - заден конектор – стандарт F
SOCKET SAT BASIC 0dB 2M
 - SAT basic
 - reduction 0dB
 - back connector – F standard



КОНЕКТОР ЗА САТЕЛИТНА ТВ КРАЕН 1 dB 1M

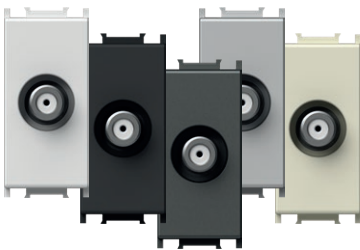

- KM16PW
- KM16SB
- KM16AT
- KM16ES
- KM16IW

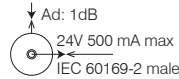

- конектор за сателитна ТВ краен
 - честотен обхват 5÷2400 MHz
 - затихване 1 dB
 - в съответствие с EN 50083-1
 - винтови контакти
SOCKET SAT END-LINE 1dB 1M
 - SAT end-line
 - frequency range 5÷2400 MHz
 - reduction < 1dB
 - in accordance with EN 50083-1
 - screw contacts



КОНЕКТОР ЗА РАДИО ОСНОВЕН 0 dB 1M



- KM19PW
- KM19SB
- KM19AT
- KM19ES
- KM19IW

- контакт за радио базов
 - затихване 0 dB
 - заден конектор – стандарт F
SOCKET R BASIC 0dB 1M
 - R basic
 - reduction 0dB
 - back connector – F standard



КОНЕКТОР ЗА РАДИО ОСНОВЕН 0 dB 2M

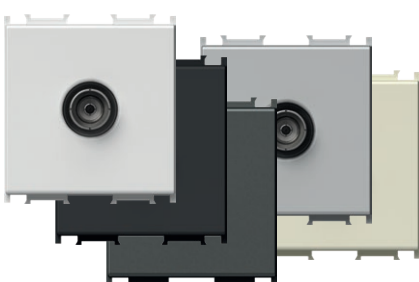

- KM29PW
- KM29SB
- KM29AT
- KM29ES
- KM29IW

- контакт за радио базов
 - затихване 0 dB
 - заден конектор – стандарт F
SOCKET R BASIC 0dB 2M
 - R basic
 - reduction 0dB
 - back connector – F standard



КОНЕКТОР ЗА САТЕЛИТНА ТВ КРАЕН 1 dB 2M



- KM25PW
- KM25SB
- KM25AT
- KM25ES
- KM25IW

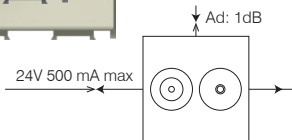

- контакт за сателитна ТВ краен
 - честотен обхват 5÷2400 MHz
 - затихване 1 dB
 - в съответствие с EN 50083-1
 - винтови контакти
SOCKET SAT-TV END-LINE 1dB 2M
 - SAT-TV end-line
 - frequency range 5÷2400 MHz
 - reduction < 1dB
 - in accordance with EN 50083-1
 - screw contacts



ПРИМЕРИ ЗА ОСНОВНО СВЪРЗВАНЕ
BASIC CONNECTION SAMPLES

индивидуално свързване
stand alone connection

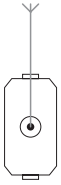

KM10
KM20
KM11
KM15
KM24
KM16
KM19
KM29
KM25

свързване тип звезда
star connection

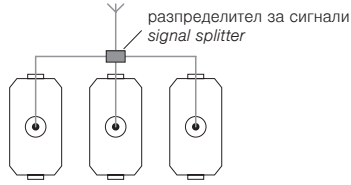

KM10
KM20
KM11
KM15
KM24
KM16
KM19
KM29
KM25

преходно свързване
throughpass connection

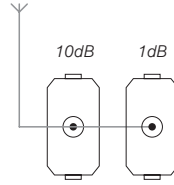

KM12 KM11



- KM22PW
- KM22SB
- KM22AT
- KM22ES
- KM22IW

КОНТАКТ ЗА АУДИОСИГНАЛИ 2xRCA 1M

- за аудиосигнали, с конектори 2x RCA
- свързване на кабела от задната страна чрез запояване

SOCKET AUDIO 2xRCA 1M

- audio 2x RCA
- soldering connection of cable at the back side



- KM23PW
- KM23SB
- KM23AT
- KM23ES
- KM23IW

КОНЕКТОР ЗА ВИСОКОГОВОРТЕЛИ 1M

- за аудиосигнали, 2x Ø4 mm
- за проводник за високоговорители, с щепсел тип банан Ø4 mm или плоски конектори
- свързване на кабела от задната страна чрез запояване

SOCKET AUDIO LOUDSPEAKERS 1M

- audio 2x Ø4mm
- to accommodate speaker wire, banana plug Ø4mm or spades
- soldering connection of cable at the back side



- KM26PW
- KM26SB
- KM26AT
- KM26ES
- KM26IW

КОНЕКТОР ЗА ВИСОКОГОВОРТЕЛИ 2M

- за аудиосигнали, 2x Ø4 mm
- за проводник за високоговорители, с щепсел тип банан Ø4 mm или плоски конектори
- свързване на кабела от задната страна чрез запояване

SOCKET AUDIO LOUDSPEAKERS 2M

- audio 2x Ø4mm
- to accommodate speaker wire, banana plug Ø4mm or spades
- soldering connection of cable at the back side



1M = 22,5 x 45
2M = 45 x 45

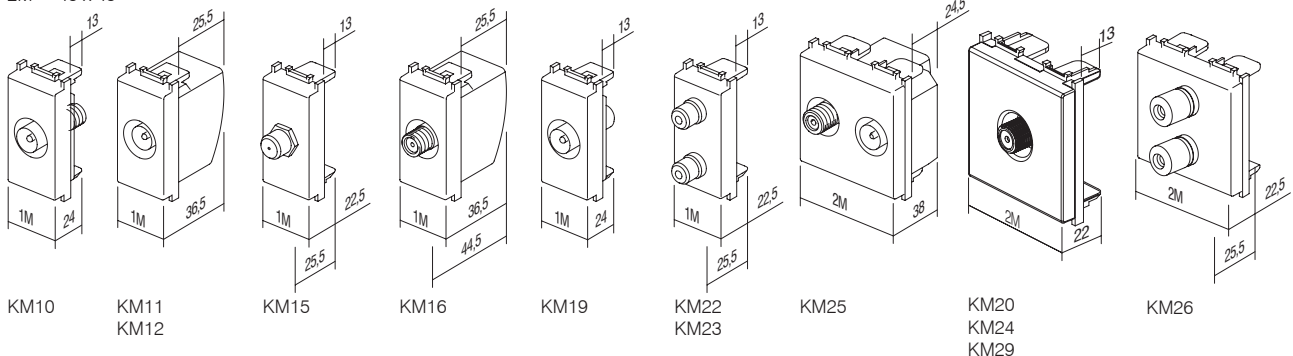

КОНЕКТОР ЗА ТЕЛЕФОН LT RJ11 6/4 1M



- KM30PW
- KM30SB
- KM30AT
- KM30ES
- KM30IW

- телефонен LT винтов
- RJ11 6/4
- в съответствие с IEC 60603-7
- винтови контакти

SOCKET TEL LT RJ11 6/4 1M

- TEL LT screw
- RJ11 6/4
- in accordance with IEC 60603-7
- screw contacts



КОНЕКТОР TEL BT SEC 6/6 1M

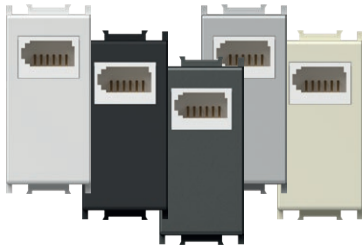

- KM31PW
- KM31SB
- KM31AT
- KM31ES
- KM31IW

- ТЕЛЕФОНЕН BT британски стандарт
- SEC вторичен 6/6
- в съответствие с BS 6312
- винтови контакти

SOCKET TEL BT SEC 6/6 1M

- TEL BT British standard
- SEC secondary 6/6
- in accordance with BS 6312
- screw contacts



КОНЕКТОР ЗА ТЕЛЕФОН KS RJ11 6/4 1M

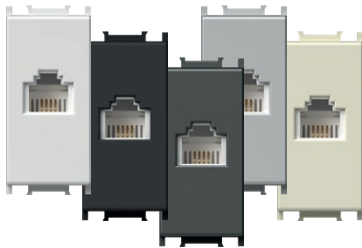

- KM36PW
- KM36SB
- KM36AT
- KM36ES
- KM36IW

- KS модулнен стандарт за закрепване
- RJ11 6/4
- в съответствие с IEC 60603-7

SOCKET TEL KS RJ11 6/4 1M

- KS keystone fixing standard
- RJ11 6/4
- in accordance with IEC 60603-7



КОНЕКТОР CAT5e KS RJ45 8/8 1M

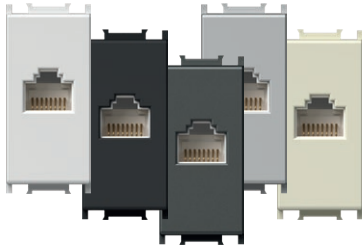

- KM37PW
- KM37SB
- KM37AT
- KM37ES
- KM37IW

- KS модулнен стандарт за закрепване
- CAT5e, RJ45 8/8
- в съответствие с IEC 60603-7

SOCKET CAT5e KS RJ45 8/8 1M

- KS keystone fixing standard
- CAT5e, RJ45 8/8
- in accordance with IEC 60603-7

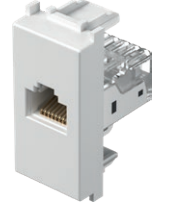

АДАПТЕР KS 1M

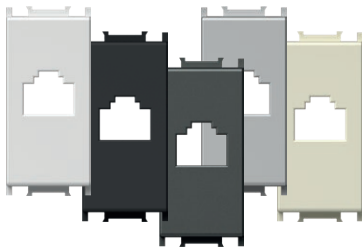

- KM35PW
- KM35SB
- KM35AT
- KM35ES
- KM35IW

- KS модулнен стандарт за закрепване
- AMP, Avaya, Brandrex, FMT, Mfico, Tyco, ...
- комуникационният модул не е включен в доставката

ADAPTER KS 1M

- KS keystone fixing standard
- AMP, Avaya, Brandrex, FMT, Mfico, Tyco, ...
- communication module not included



АДАПТЕР СЪС ЗАЩИТА ПРОТИВ ПРАХ 1M



- KM38PW
- KM38SB
- KM38AT
- KM38ES
- KM38IW

- KS модулнен стандарт за закрепване със защита против прах
- AMP, Avaya, Brandrex, FMT, Mfico, Tyco, ...
- комуникационният модул не е включен в доставката

ADAPTER KS WITH DUST PROTECTION 1M

- KS keystone fixing standard with dust protection
- AMP, Avaya, Brandrex, FMT, Mfico, Tyco, ...
- communication module not included



КОНЕКТОР CAT6 SCH KS RJ45 8/8 1M

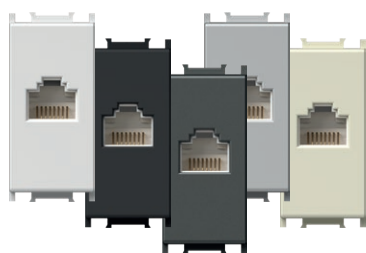

- KM39PW
- KM39SB
- KM39AT
- KM39ES
- KM39IW

- KS модул стандарт за закрепване
- CAT6 UTP без нужда от инструменти, RJ45 8/8
- в съответствие с ISO/IEC 11801

SOCKET CAT6 SCH KS RJ45 8/8 1M

- KS keystone fixing standard
- CAT6 UTP toolless, RJ45 8/8
- in accordance with ISO/IEC 11801



УНИВЕРСАЛЕН АДАПТЕР KS 1M

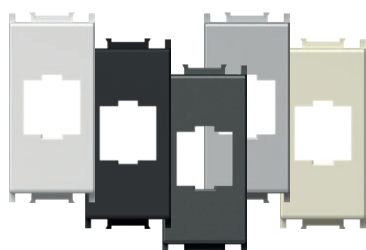

- KM50PW
- KM50SB
- KM50AT
- KM50ES
- KM50IW

- KS модул стандарт за закрепване
- подходящ за HDMI, USB
- комуникационният модул не е включен в доставката

ADAPTER KS UNIVERSAL 1M

- KS keystone fixing standard
- suitable for HDMI, USB
- communication module not included

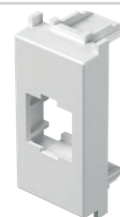

АДАПТЕР PD 1M

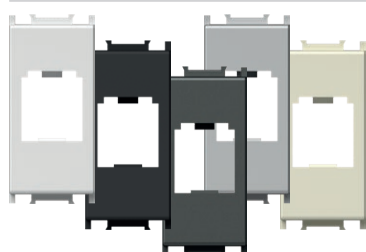

- KM40PW
- KM40SB
- KM40AT
- KM40ES
- KM40IW

- стандарт за закрепване PD Panduit Mini-COM
- комуникационният модул не е включен в доставката

ADAPTER PD 1M

- PD Panduit Mini-COM fixing standard
- communication module not included



АДАПТЕР PD СЪС ЗАЩИТА ПРОТИВ ПРАХ 1M



- KM43PW
- KM43SB
- KM43AT
- KM43ES
- KM43IW

- стандарт за закрепване PD Panduit Mini-COM със защита против прах
- комуникационният модул не е включен в доставката

ADAPTER PD WITH DUST PROTECTION 1M

- PD Panduit Mini-COM fixing standard with dust protection
- communication module not included



АДАПТЕР R&M 1M

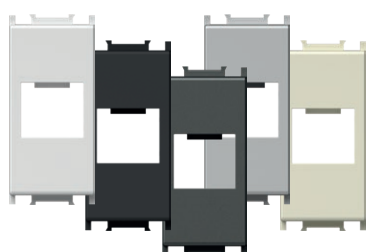

- KM46PW
- KM46SB
- KM46AT
- KM46ES
- KM46IW

- стандарт за закрепване R&M
- комуникационният модул не е включен в доставката

ADAPTER R&M 1M

- R&M fixing standard
- communication module not included



АДАПТЕР R&M CAT6A 1M

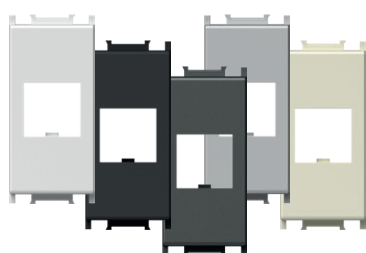

- KM52PW
- KM52SB
- KM52AT
- KM52ES
- KM52IW

- закрепване R&M за CAT6A
- комуникационният модул не е включен в доставката

ADAPTER R&M CAT6A 1M

- R&M fixing for CAT6A
- communication module not included





- KM47PW
- KM47SB
- KM47AT
- KM47ES
- KM47IW

АДАПТЕР R&M СЪС ЗАЩИТА ПРОТИВ ПРАХ 1M

- стандарт за закрепване R&M със защита против прах
- комуникационният модул не е включен в доставката

ADAPTER R&M WITH DUST PROTECTION 1M

- R&M fixing standard with dust protection
- communication module not included



- KM53PW
- KM53SB
- KM53AT
- KM53ES
- KM53IW

АДАПТЕР R&M CAT6A СЪС ЗАЩИТА ПРОТИВ ПРАХ 1M

- закрепване R&M за CAT6A със защита против прах
- комуникационният модул не е включен в доставката

ADAPTER R&M CAT6A WITH DUST PROTECTION 1M

- R&M fixing for CAT6A with dust protection
- communication module not included



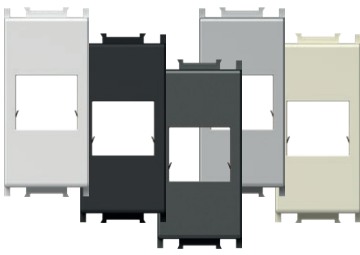

- KM45PW
- KM45SB
- KM45AT
- KM45ES
- KM45IW

АДАПТЕР LK 1M

- стандарт за закрепване LK LeoniKerpen eLine/BKS NewLine
 - комуникационният модул не е включен в доставката

ADAPTER LK 1M

- LK LeoniKerpen eLine / BKS NewLine fixing standard
 - communication module not included

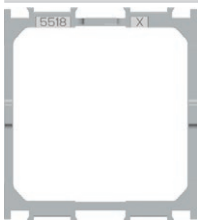

KA26

АДАПТЕР NEXANS/SCHRACK 2M

- адаптер за закрепване за Nexans LANmark и
 LANmark за Schrack размер 45x45 mm
 - модул Schrack 45x45 mm
 - подходящ за Schrack тип HSEMD02W2F
 - комуникационният модул не е включен в доставката

ADAPTER NEXANS/SCHRACK 2M

- fixing adapter for Nexans LANmark and
 Schrack module 45x45mm
 - suitable for Nexans type N423.540N
 - suitable for Schrack type HSEMD02W2F
 - communication module not included

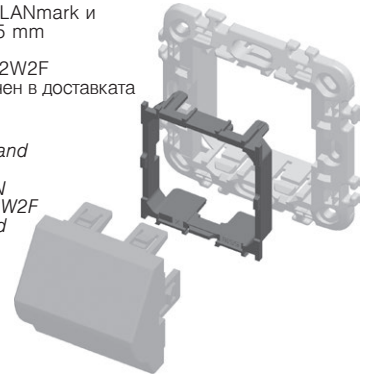

- KM48PW
- KM48SB
- KM48AT
- KM48ES
- KM48IW

АДАПТЕР AT&T SYSTIMAX СЪС ЗАЩИТА ПРОТИВ ПРАХ 1M

- стандарт за закрепване AT&T Systimax със защита против прах
 - комуникационният модул не е включен в доставката

ADAPTER AT&T SYSTIMAX WITH DUST PROTECTION 1M

- AT&T Systimax fixing standard with dust protection
 - communication module not included



- KM51PW
- KM51SB
- KM51AT
- KM51ES
- KM51IW

КОНЕКТОР USB ТИП А 1M

- конектор тип А за USB 2.0
 - винтови контакти, стъпка 5 mm, 1,5 mm², 1x2P + 1x3P
 - свързване:
 Щифт 1 – VCC (+5V, червен проводник)
 Щифт 2 – Данни – (бял проводник)
 Щифт 3 – Данни + (зелен проводник)
 Щифт 4 – МАСА - (черен проводник)
 S – екранировка
 - в съответствие с Директива 2011/95/EC (RoHS2)

SOCKET USB TYPE A 1M

- USB 2.0 socket type A
 - screw contacts, raster 5 mm, 1,5 mm², 1x2P + 1x3P
 - wiring:
 PIN 1 – VCC (+5V, red wire)
 PIN 2 – Data – (white wire)
 PIN 3 – Data + (green wire)
 PIN 4 – GND - ground (black wire)
 S – shield
 - in accordance with directive 2011/95/EU (RoHS2)



1M = 22,5 x 45
 2M = 45 x 45

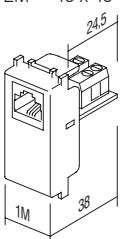

KM30

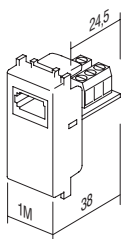

KM31

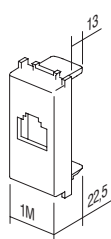

KM35
 KM38
 KM48

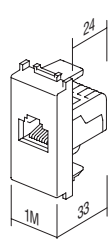

KM36
 KM37
 KM39

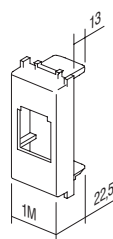

KM40
 KM43

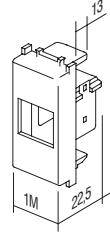

KM45

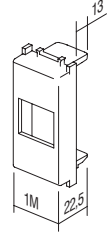

KM46
 KM47
 KM50
 KM52
 KM53

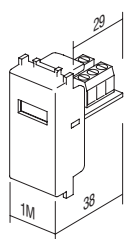

KM51



KA10

тип <i>type</i>	описание <i>description</i>	технически данни <i>technical data</i>
KA10	КОНЕКТОР KS CAT3 <i>CONNECTOR KS CAT3</i>	RJ11 6/4
KA11	КОНЕКТОР KS CAT5e <i>CONNECTOR KS CAT5e</i>	RJ45 8/8
KA12	КОНЕКТОР KS CAT5eS <i>CONNECTOR KS CAT5eS</i>	RJ45 8/8
⋮	⋮	⋮



KA10	КОНЕКТОР KS CAT3 RJ11 6/4 - KS модул стандарт за закрепване - CAT3, RJ11 6/4 - в съответствие с IEC 60603-7 <i>CONNECTOR KS CAT3 RJ11 6/4</i> - KS keystone fixing standard - CAT3, RJ11 6/4 - in accordance with IEC 60603-7
------	---



KA11	КОНЕКТОР KS CAT5e RJ45 8/8 - KS модул стандарт за закрепване - CAT5e, RJ45 8/8 - в съответствие с IEC 60603-7 <i>CONNECTOR KS CAT5e RJ45 8/8</i> - KS keystone fixing standard - CAT5e, RJ45 8/8 - in accordance with IEC 60603-7
------	---



KA12	КОНЕКТОР KS CAT5eS RJ45 8/8 - KS модул стандарт за закрепване - CAT5eS, RJ45 8/8 - в съответствие с IEC 60603-7 <i>CONNECTOR KS CAT5eS RJ45 8/8</i> - KS keystone fixing standard - CAT5eS, RJ45 8/8 - in accordance with IEC 60603-7
------	---



KA15	КОНЕКТОР KS CAT6 SCH RJ45 8/8 - KS модул стандарт за закрепване - CAT6 UTP без нужда от инструменти, RJ45 8/8 - в съответствие с ISO/IEC 11801 <i>CONNECTOR KS CAT6 SCH RJ45 8/8</i> - KS keystone fixing standard - CAT6 UTP toolless, RJ45 8/8 - in accordance with ISO/IEC 11801
------	---



KA16	КОНЕКТОР KS CAT6S SCH RJ45 8/8 - KS модул стандарт за закрепване - CAT6S STP без нужда от инструменти, RJ45 8/8 - в съответствие с ISO/IEC 11801 <i>CONNECTOR KS CAT6S SCH RJ45 8/8</i> - KS keystone fixing standard - CAT6S STP toolless, RJ45 8/8 - in accordance with ISO/IEC 11801
------	---



KA17	КОНЕКТОР KS CAT6a SCH RJ45 8/8 - KS модул стандарт за закрепване - CAT6a STP без нужда от инструменти, RJ45 8/8 - в съответствие с ISO/IEC 11801 <i>CONNECTOR KS CAT6a SCH RJ45 8/8</i> - KS keystone fixing standard - CAT6a STP toolless, RJ45 8/8 - in accordance with ISO/IEC 11801
------	---



KA18

КОНЕКТОР SLIM KS CAT6S SCH RJ45 8/8

- KS модул стандарт за закрепване
- компактно изпълнение
- CAT6S STP без нужда от инструменти, RJ45 8/8
- в съответствие с ISO/IEC 11801
- също така е подходящ за двоен адаптор KE46

CONNECTOR SLIM KS CAT6S SCH RJ45 8/8

- KS keystone fixing standard
- slim style
- CAT6S STP toolless, RJ45 8/8
- in accordance with ISO/IEC 11801
- suitable also for KE46 double adapter



KA27

КОНЕКТОР KS HDMI

- KS модул стандарт за закрепване
- само в комбинация с адаптер KM50
- HDMI/HDMI

CONNECTOR KS HDMI

- KS keystone fixing standard
- only in combination with adapter KM50
- HDMI/HDMI



KA28

КАБЕЛ KS HDMI

- KS модул стандарт за закрепване
- само в комбинация с адаптер KM50
- HDMI/HDMI

CABLE KS HDMI

- KS keystone fixing standard
- only in combination with adapter KM50
- HDMI/HDMI



EM31

PW

тип type	описание description	технически данни technical data	размер size	цвет colour
EM10	ДИМЕР, ВЪРТЯЩ ТИП DIMMER ROTATIVE	R 300W	1M	<input type="checkbox"/> PW снежнобял цвят polar white
EM12	ДИМЕР, ВЪРТЯЩ ТИП/ДВУПОСОЧЕН, АКТИВЕН/ИНДУКТИВЕН ТОВАР DIMMER ROTATIVE 2WAY	RL 300W	1M	<input checked="" type="checkbox"/> SB сензорен бутон, черен soft touch black
EM23	DIMMER INBOX DIMMER INBOX	RC,RL 200VA	/	<input checked="" type="checkbox"/> AT антрацит anthracite
·	·	·	·	<input type="checkbox"/> ES сребрист elox silver
·	·	·	·	<input type="checkbox"/> IW слоновя кост ivory white
·	·	·	·	<input type="checkbox"/> BL син цвят blue
·	·	·	·	<input type="checkbox"/> RD червен red
·	·	·	·	<input type="checkbox"/> GR зелен green
·	·	·	·	<input type="checkbox"/> OR оранжев orange
·	·	·	·	<input type="checkbox"/> RG червен/зелен red/green

ДИМЕР, ВЪРТЯЩ ТИП, R 300W 1M



- EM10PW
- EM10SB
- EM10AT
- EM10ES
- EM10IW

- управление чрез завъртане, без ключ
- тип RTS34, 43 RVP, активен товар, 40 W – 300 W
- захранващо напрежение 230 V ~ 50 Hz
- не е възможна комбинация с двупосочен ключ
- не се допуска комбинация с допълнителни димери
- в съответствие с EN 60669-1
- винтови контакти 1,5 - 2,5 mm²
- светодиодна индикация



- DIMMER ROTATIVE R 300W 1M**
- rotation control without switch
 - type RTS34, 43 RVP, load R, 40W - 300W
 - supply voltage 230V ~ 50Hz
 - 2-way switch combination is not possible
 - more dimmers combination is not allowed
 - in accordance with EN 60669-1
 - screw contacts 1.5-2.5mm²
 - LED indication

ДИМЕР, ВЪРТЯЩ ТИП/ДВУПОСОЧЕН, АКТИВЕН/ИНДУКТИВЕН ТОВАР 300 W 1M



- EM12PW
- EM12SB
- EM12AT
- EM12ES
- EM12IW

- управление чрез завъртане, с двупосочен ключ
- активен/индуктивен товар, 40 W – 300 W
- захранващо напрежение 230 V ~ 50 Hz
- възможна е комбинация с двупосочен ключ
- допуска се инсталиране на няколко устройства заедно в една конзола само ако общият им максимален товар не превишава максималната мощност на един димер
- една верига позволява използване само на един димер
- без вграден предпазител – трябва да се използва външен предпазител
- в съответствие с EN 60669-1
- винтови контакти – 1,5-2,5 mm²
- интегрирана светодиодна индикация за нивото на димиране

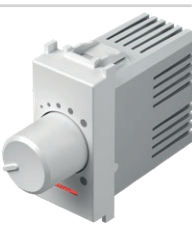

- DIMMER ROTATIVE/2WAY RL 300W 1M**
- rotation control with 2-way switch
 - load RL, 40W - 300W
 - supply voltage 230V ~ 50Hz
 - 2-way switch combination is possible
 - installing several devices together in one box is only permitted if their total maximum load does not exceed the maximum power of a single dimmer
 - one circuit allows the use of only one dimmer
 - no built-in fuse – external fuse must be used
 - in accordance with EN 60669-1
 - screw contacts - 1.5-2.5mm²
 - integrated LED indication of dimming level



- EM13PW
- EM13SB
- EM13AT
- EM13ES
- EM13IW

ДИМЕР, ВЪРТЯЩ ТИП ДВУПОСОЧЕН, ЗА СВЕТОДИОДНО ОСВЕТЛЕНИЕ 60 W 1M

- управление чрез завъртане, с двупосочен ключ
- товар: светодиодно осветление, 0 – 60 W (макс. 6 димируеми светодиодни лампи)
GLS, 0 – 60 W
- захранващо напрежение 230 V~ 50 Hz
- възможна е комбинация с двупосочен ключ
- допуска се инсталиране на няколко устройства заедно в една конзола само ако общият им максимален товар не превишава максималната мощност на един димер
- една верига позволява използване само на един димер
- без вграден предпазител – трябва да се използва външен предпазител
- в съответствие с IEC60669-2-1
- винтови контакти – 1,5-2,5 mm²



DIMMER ROTATIVE/2WAY LED 60W 1M

- rotation control with 2-way switch
- loads: LED, 0 – 60W (max. 6 dimmable LED lamps)
GLS, 0 – 60W
- supply voltage 230V~ 50Hz
- 2-way switch combination is possible
- installing several devices together in one box is only permitted if their total maximum load does not exceed the maximum power of a single dimmer
- one circuit allows the use of only one dimmer
- no built-in fuse – external fuse must be used
- in accordance with IEC60669-2-1
- screw contacts - 1.5-2.5mm²



- EM14PW
- EM14SB
- EM14AT
- EM14ES
- EM14IW

ДИМЕР, ВЪРТЯЩ ТИП ДВУПОСОЧЕН, ЗА СВЕТОДИОДНО ОСВЕТЛЕНИЕ 180W 1M

- управление чрез завъртане, с двупосочен ключ
- товар: светодиодно осветление, 0 – 180 W (макс. 20 димируеми светодиодни лампи)
GLS, 0 – 180 W
- захранващо напрежение 230 V~ 50 Hz
- възможна е комбинация с двупосочен ключ
- допуска се инсталиране на няколко устройства заедно в една конзола само ако общият им максимален товар не превишава максималната мощност на един димер
- една верига позволява използване само на един димер
- без вграден предпазител – трябва да се използва външен предпазител
- в съответствие с IEC60669-2-1
- винтови контакти – 1,5-2,5 mm²



DIMMER ROTATIVE/2WAY LED 180W 1M

- rotation control with 2-way switch
- loads: LED, 0 – 180W (max. 20 dimmable LED lamps)
GLS, 0 – 180W
- supply voltage 230V~ 50Hz
- 2-way switch combination is possible
- installing several devices together in one box is only permitted if their total maximum load does not exceed the maximum power of a single dimmer
- one circuit allows the use of only one dimmer
- no built-in fuse – external fuse must be used
- in accordance with IEC60669-2-1
- screw contacts - 1.5-2.5mm²



- EM15PW
- EM15SB
- EM15AT
- EM15ES
- EM15IW

ДИМЕР, ВЪРТЯЩ ТИП, R 250W 1M

- управление чрез завъртане, без ключ
- активен товар, 40 W – 250 W
- захранващо напрежение 230 V~ 50 Hz
- не е възможна комбинация с двупосочен ключ
- не се допуска комбинация с допълнителни димери
- в съответствие с EN 60669-1
- винтови контакти 1,5 - 2,5 mm²
- светодиодна индикация



DIMMER ROTATIVE R 250W 1M

- rotation control without switch
- load R, 40W - 250W
- supply voltage 230V~ 50Hz
- 2-way switch combination is not possible
- more dimmers combination is not allowed
- in accordance with EN 60669-1
- screw contacts 1.5-2.5mm²
- LED indication



EM23

ДИМЕР, ВГРАДЕН, ЗА АКТИВЕН ТОВАР (250 W), (АКТИВЕН КАПАЦИТИВЕН, АКТИВЕН ИНДУКТИВЕН ТОВАР 200 VA)

- вграден, управлява се от външен бутон
- активен/индуктивен/капацитивен товар 15-250 W или 15-200 VA
- захранващо напрежение 230 V \sim 50 Hz
- възможни са комбинации от няколко бутона
- не се допуска комбинация с допълнителни димери
- памет за интензивността на осветлението
- функция за плавно стартиране/спиране
- »leading edge«
- в съответствие с EN60669, EN60950, EN 61000, ETSI EN 300 220-1, ETSI EN 300 220-2
- винтови контакти за проводници 2,5 mm 2

DIMMER INBOX R (250 W), (RC, RL 200 VA)

- *inbox, controlled by external push button*
- *load RLC 15-250W or 15-200 VA*
- *supply voltage 230V \sim 50Hz*
- *several push-buttons combinations are possible*
- *more dimmers combination is not allowed*
- *light intensity memory*
- *soft start/stop function*
- *»leading edge«*
- *in accordance with EN60669, EN60950, EN 61000, ETSI EN 300 220-1, ETSI EN 300 220-2*
- *screw contacts to wires 2,5 mm 2*



EM18

ДИМЕРНО УСТРОЙСТВО ЗА СВЕТОДИОДИ 250W

- вградена кутия, управлява се външно чрез бутон
- за индуктивен и капацитивен товар
- захранващо напрежение 230 V \sim 50 Hz
- възможни са няколко комбинации с бутони
- памет за интензитета на светлината
- функция за плавен старт/стоп
- контрол на минималния интензитет
- само един димер за стенна кутия
- само за употреба на закрито
- в съответствие с EN 60669-1 и EN 60669-2-1

DIMMER INBOX LED 250W

- *inbox, controlled by external push button*
- *for leading or trailing edge*
- *supply voltage 230V \sim 50Hz*
- *several push-buttons combinations is possible*
- *light intensity memory*
- *soft start / stop function*
- *minimum intensity control*
- *only one dimmer per wall box*
- *only for indoor usage*
- *in accordance with EN 60669-1 and EN 60669-2-1*



EM19

ДИМЕРНО УСТРОЙСТВО ЗА СВЕТОДИОДИ, ПОСТОЯНЕН ТОК 96 W

- вградена кутия, управлява се външно чрез бутон
- за употреба със светодиодни драйвери с постоянно напрежение и някои светодиодни драйвери с постоянен ток, 9 – 48 V DC, макс. 96 W (подходящо и за светодиодни ленти)
- не е подходящо за употреба при индуктивен товар
- възможни са комбинации от няколко бутона и няколко димера
- памет за интензитета на светлината
- функция за плавен старт/стоп
- само един димер за стенна кутия
- само за употреба на закрито

DIMMER INBOX DC LED 96W

- *inbox, controlled by external push button*
- *for use with constant voltage LED drivers and some constant current LED drivers, 9-48V DC, max 96W (also for LED strips)*
- *not for use with inductive loads*
- *several push-buttons combinations and several dimmers is possible*
- *light intensity memory*
- *soft start / stop function*
- *only one dimmer per wall box*
- *only for indoor usage*

EM10 (40÷300W)
EM15 (40÷250W)

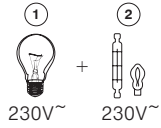

EM12 (40÷300W)

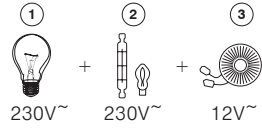

EM13 (0÷60W), EM14 (0÷180W),
EM23 (15÷250W, 15÷200VA),
EM18 (2÷250VA (3=10÷250VA), 2÷250W)

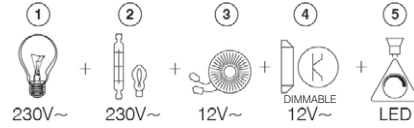

- 1 – лампа с нажежаема жичка / incandescent lamp
- 2 – халогенна лампа / halogen lamp
- 3 – класически трансформатор / classical transformer
- 4 – Димиращ електронен трансформатор / dimmable electronic transformer
- 5 – димируема светодиодна лампа / dimmable LED lamp

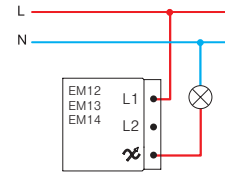
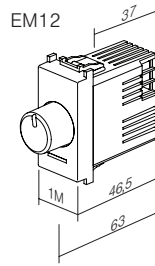
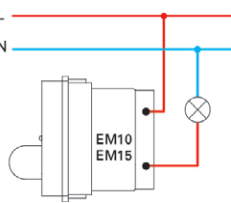
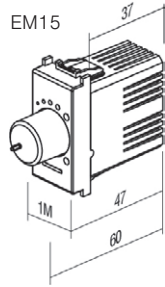
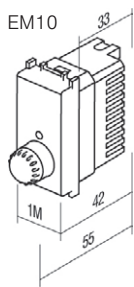

EM23

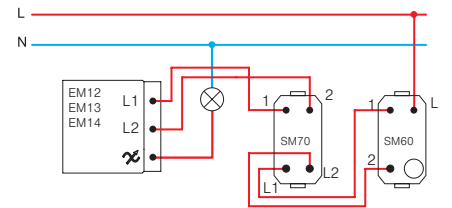
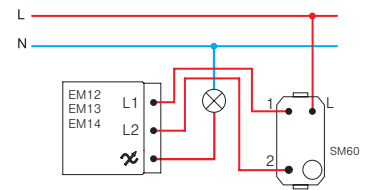
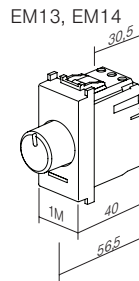
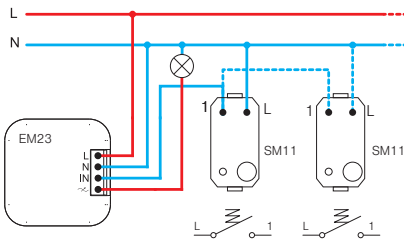
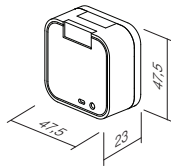

EM18

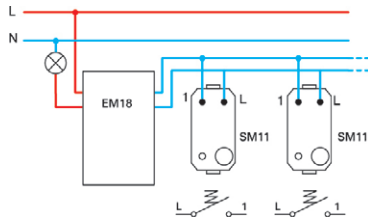
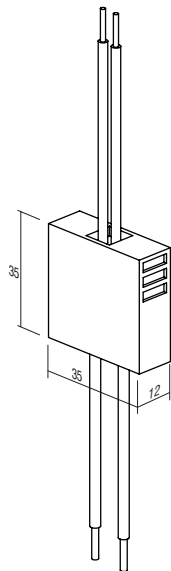

EM19

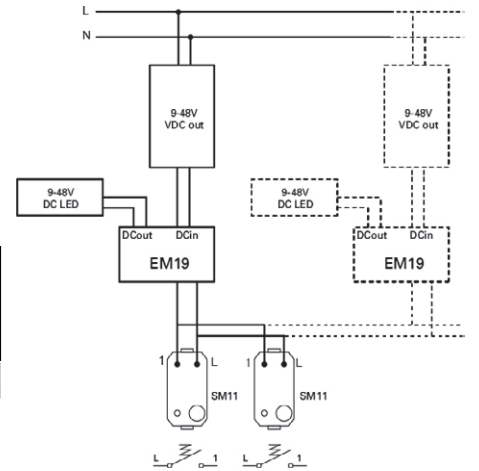
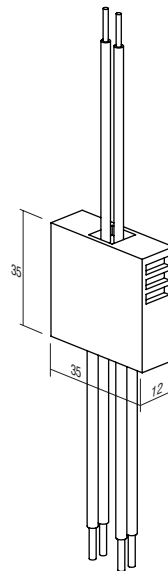

ВНИМАНИЕ!

Ако няколко димера са свързани в една конзола, намалете допустимата обща максимална мощност с 10 % за всеки димер.

ATTENTION!

If more dimmers are connected in one box reduce maximum common power for 10% for each dimmer.

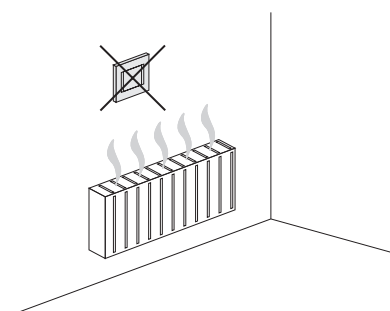

КЛЮЧ УНИВЕРСАЛЕН ДИМЕР ЗА АКТИВЕН ИНДУКТИВЕН КАПАЦИТИВЕН ТОВАР 0-300 W 2M

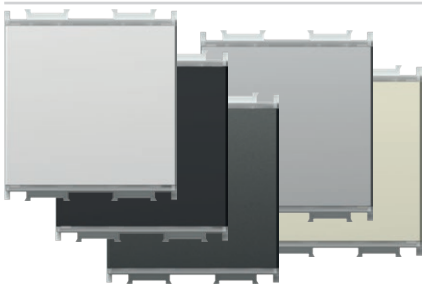

- EM25PW
- EM25SB
- EM25AT
- EM25ES
- EM25IW

- универсален електронен димер за включване, изключване и димиране на всички лампи, позволяващи димиране (класически, халогенни, светодиодни, газоразрядни...) и някои видове лампи, не позволяващи димиране
- автоматично определяне на типа на лампата и регулиране на работния режим
- намалена консумация на енергия
- функцията за плавно стартиране/спиране удължава живота на лампите
- управление чрез вградени микроключета
- съдържа функция за запазване – запомня силата на осветлението в момента на изключване
- допълнително може да се свържат до пет (5) устройства за управление EM26
- не е възможно свързване с двупосочен ключ
- вградена защита против късо съединение, прегряване и претоварване
- захранващо напрежение 230 V ~ 50 Hz
- елегантно светодиодно осветление, регулиране на цвета и яркостта
- замяна на обикновен ключ е възможно при двупроводно свързване (1)
- замяна на обикновен ключ е възможно при двупроводно свързване (2)
- в съответствие с EN 60669-1 и EN 60669-2-1
- винтови контакти за проводници 1,5 mm² (макс. въртящ момент за притягане 0,4 Nm)



TOUCH EM25 е управляван от микропроцесор електронен димер за осветление. Той служи за ключ и димер за лампи, позволяващи димиране, и за някои видове лампи, не позволяващи димиране. Интегрираният микропроцесор автоматично идентифицира типа на лампата и напасава работния режим. Благодарение на интегрираната функция за запазване се запомня нивото на димиране след изключване. Функцията за плавно стартиране/спиране удължава експлоатационния живот на лампите. Вграденото в бутон елегантно светодиодно осветление дава възможности за голям брой различни цветове и нива на осветеност. Като опция е възможно свързване на максимално 5 допълнителни управляващи устройства EM26 («подчинени устройства») към EM 25.

TOUCH EM25 is microprocessor controlled electronic light dimmer. It serves as switch and dimmer for dimmable and some of non-dimmable lamps. Integrated microprocessor automatically identifies the type of lamp and adjusts the operating mode. It remembers the level of dimming after switching off due to integrated memory function. Soft-start function extends the lamp service life. In button integrated elegant LED illumination enables many different colours and intensity levels. Optionally one can connect up to 5 additional control tasters EM26 («slave»).

SWITCH / DIMMER UNIVERSAL RLC 0-300W 2M

- universal electronic dimmer for ON/OFF switching and dimming of all dimmable lamps (classical, halogen, LED, CFL, ...) and some non-dimmable lamps
- automatic detection of lamp type and adjustment of operating mode
- reduction of energy consumption
- soft start function extends life of lamps
- controlled by build-in micro switches
- memory function included – memorizes brightness on turn-off
- up to five (5) additional control units EM26 can be connected
- connection with 2-way switch is not possible
- build-in short-circuit, overheating and overload protection
- supply voltage 230V ~ 50Hz
- elegant LED illumination, adjustable colour and brightness
- replacement of classical switch is possible at two-wire connection⁽¹⁾
- full functionality is achieved at three-wire connection⁽²⁾
- in accordance with EN 60669-1 and EN 60669-2-1
- screw contacts 1.5mm² (max. tightening torque 0.4Nm)

(1) двупроводно свързване
two-wire connection

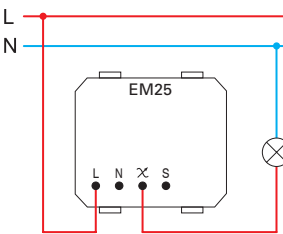

- двупроводното свързване дава възможност за димиране на лампи, позволяващи димиране

- two-wire connection allows dimming of dimmable lamps

(2) трипроводно свързване
three-wire connection

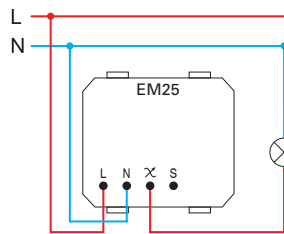

- трипроводното свързване дава възможност за димиране на лампи, позволяващи димиране, и на някои видове не позволяващи димиране светодиодни и газоразрядни лампи

- three-wire connection allows dimming of dimmable lamps and some of non-dimmable LED and CFL lamps

	1	2	5	6	7
Min.	40 W	40 W	40 VA	40 VA	40 VA
Max.	300 W	300 W	300 VA	100 VA	100 VA
	(F)	(F)	(F)		

- 1 – лампа с нажежаема жичка / incandescent lamp
- 2 – халогенна лампа / halogen lamp

- 4 – Димиращ електронен трансформатор / dimmable electronic transformer
- 5 – класически трансформатор / classical transformer

	1	2	4	6	7	8	9
Min.	0 W	0 W	0 VA	0 VA	0 VA	0 VA	0 VA
Max.	300 W	300 W	120 VA	120 VA	120 VA	120 VA	120 VA
	(F)	(F)	(F)			(F)	(F)

- 6 – икономия на енергия при димиране на газоразрядна лампа / dimmable energy saving CFL lamp
- 7 – димируема светодиодна лампа / dimmable LED lamp

- 8 – без икономия на енергия при димиране на газоразрядна лампа / non-dimmable energy saving CFL lamp
- 9 – недимируема светодиодна лампа / non-dimmable LED lamp

бележки / remarks

- (F) филтър EM27
- препоръчва се използване на филтър EM27 / it is recommended to use filter EM27
- всички управлявани лампи трябва да са от един тип / all controlled lamps must be the same
- таблицата за товара е валидна за лампи с коефициент на мощност PF>0,5 / table of loads is valid for lamps with power factor PF>0.5

- включване, изключване и димиране на лампа /
on / off swithcing and dimming of lamp

- избиране на цвета на светодиодите и регулиране на нивото на осветеност /
LED colour selection and intensity level adjustment

* функция за „нулиране“ (RESET) /
"RESET" function

включване/изключване
кратковременно
натискане
on / off
short press

изключване на лампата
кратковременно натискане
lamp off
short press

изключване на лампата
кратковременно натискане
lamp off
short press

усилване на димирането
продължително натискане
dimming up
long press

едновременно натискане ~3
сек интегрираният светодиод
примигва 3 пъти
simultaneous press ~3s
integrated LED blinks 3
times

едновременно натискане ~3
сек интегрираният светодиод
примигва 3 пъти
simultaneous press ~3s
integrated LED blinks 3
times

намалвяване на
димирането
продължително
натискане
dimming down
long press

избиране на цвят
кратковременно натискане
colour selection
short press

едновременно натискане ~5
сек интегрираният светодиод
примигва 5 пъти
re-simultaneous press ~5s
integrated LED blinks 5
times

интегриран светодиод за увеличаване
на нивото на димиране продължително
натискане
integrated LED dimming up
long press

интегриран светодиод за намалвяване на нивото
на димиране продължително натискане
integrated LED dimming
down
long press

запаметвяване на настройката – едновременно
кратковременно натискане
интегрираният светодиод примигва 3 пъти
settings saving - simultaneous short
press
integrated LED blinks 3 times

- * - препоръчва се при инсталиране на димер и смяна на лампи
- задължително, ако се използват лампи, не позволяващи димиране
- функцията за „нулиране“ (RESET) не е налична при използване на двупроводно свързване
- възможно е само за EM25
- it is recommended at dimmer installation and lamp replacement
- mandatory when using non-dimmable lamps
- "RESET" function is not possible when using two-wire connection
- only possible on EM25

предупреждения във връзка с инсталирането /
installation precautions

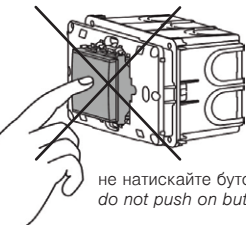
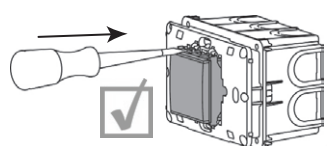
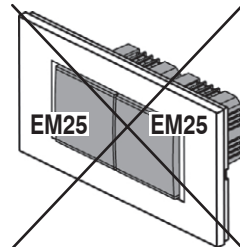
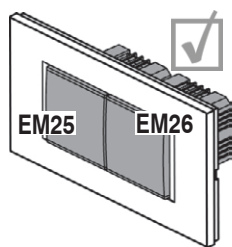

не натискайте бутона по време на монтажа
do not push on button during mounting

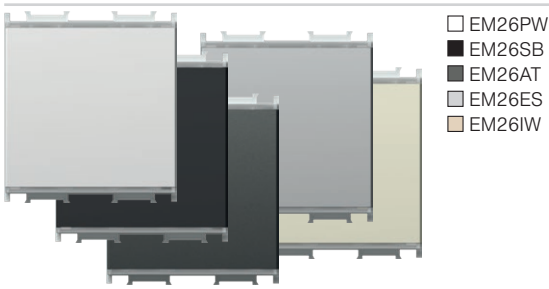

БУТОННО УСТРОЙСТВО ЗА УПРАВЛЕНИЕ 2M

- свързано към универсален димер EM25 дава възможност за управление на лампи със същата функционалност (максимално до) като EM25
- захранващо напрежение 230 V \sim 50 Hz
- в съответствие с EN 60669-1 и EN 60669-2-1
- винтови контакти за проводници 1,5 mm² (макс. въртящ момент за притягане 0,4 Nm)

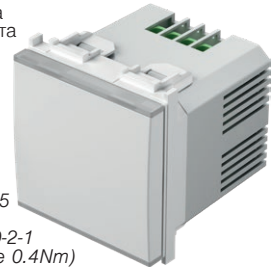

PUSH-BUTTON CONTROL UNIT 2M

- connected to universal dimmer EM25 allows controlling of lamps with same functionality as EM25
- supply voltage 230V \sim 50Hz
- in accordance with EN 60669-1 and EN 60669-2-1
- screw contacts 1.5mm² (max. tightening torque 0.4Nm)

(1) двупроводно свързване
two-wire connection

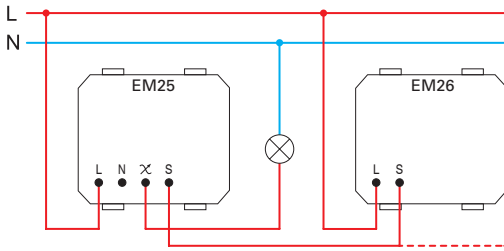

- двупроводното свързване дава възможност за димиране на лампи, позволяващи димиране
- при двупроводно свързване всяко допълнително устройство за управление увеличава минималния товар с 25 W
- *two-wire connection allows dimming of dimmable lamps*
- *in a two-wire connection each additional control unit increases the minimum load by 25W*

(2) трипроводно свързване
three-wire connection

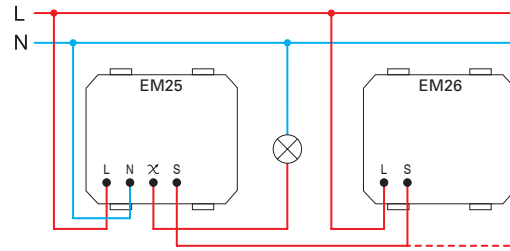

- трипроводното свързване дава възможност за димиране на лампи, позволяващи димиране, и на някои видове не позволяващи димиране светодиодни и газоразрядни лампи
- *three-wire connection allows dimming of dimmable lamps and some of non-dimmable LED and CFL lamps*



EM27

ЧЕСТОТЕН ФИЛТЪР

- честотен филтър за EM25
- изображението е символично
- FREQUENCY FILTER**
- frequency filter for EM25
- image is symbolic

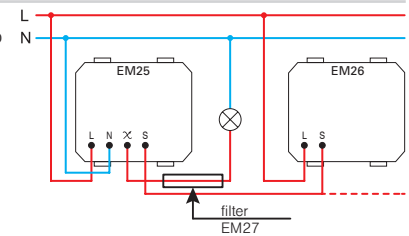

EM25PPOL20

КОМПЛЕКТ КЛЮЧНИ УНИВЕРСАЛЕН ДИМЕР ЗА АКТИВЕН ИНДУКТИВЕН КАПАЦИТИВЕН ТОВАР 0-300 W 2M PP OL20

- комплектът съдържа димер EM25, монтажна рамка 2M и панел LINE 2M PW
- за технически подробности вижте EM25
- SET SWITCH / DIMMER UNIVERSAL RLC 0-300W 2M PP OL20**
- set includes dimmer EM25, mounting frame 2M and cover plate LINE 2M PW
- for technical details see EM25



2M = 45 x 45

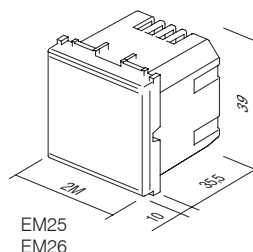

EM25
EM26



- EM31PW
- EM31SB
- EM31AT
- EM31ES
- EM31IW

КЛЮЧ IR 5 A 230 V~ 1M

- инфрачервен ключ IR
- захранващо напрежение: 230 V~ ±10 % 50 Hz
- реле: 5 A/250 V~ (нулевата стойност)
- клас на защита: IP40
- сечение на проводниците при контакта 0,75 - 2,5 mm²
- ъгъл на откриване: до 110° при 20° C
- разстояние на откриване: пригл. 8 m при 20° C
- регулируема продължителност: от пригл. 5 сек до 12 мин
- регулиране на яркостта на осветлението: от пригл. 5 до 200 лукса
- работна температура: от 0° C до +40° C
- не е подходящо за инсталиране в конзоли с дълбочина 45 mm и конзоли за външен монтаж CUBO IP20
- само за използване на закрито



IR SWITCH 5A 230V~ 1M

- IR infrared switch
- supply voltage: 230V~ ±10 % 50Hz
- relay: 5A / 250V~ (zero crossing)
- protection rating: IP40
- cross-section of wires at the contact terminal: 0.75 - 2.5 mm²
- detection angle: up to 110° at 20°C
- detection area: approx. 8 m at 20°C
- adjustability of duration: from approx. 5 s to 12 min
- adjustability of brightness: from approx. 5 to 200 LUX
- operating temperature: from 0°C to +40°C
- not suitable for installation in 45 mm deep boxes and surface mount box CUBO IP20
- only for indoor usage

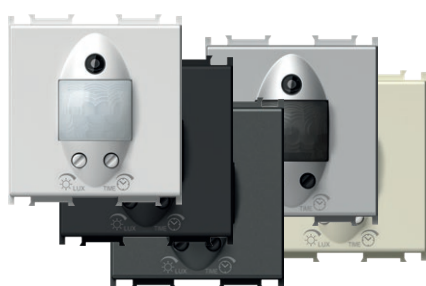

- EM32PW
- EM32SB
- EM32AT
- EM32ES
- EM32IW

КЛЮЧ IR 5 A 230V~ 2M

- инфрачервен ключ IR
- захранващо напрежение: 230 V~ ±10 % 50 Hz
- реле: 5 A/250 V~ (нулевата стойност)
- клас на защита: IP40
- сечение на проводниците при контакта 0,75 - 2,5 mm²
- ъгъл на откриване: до 110° при 20° C
- разстояние на откриване: пригл. 8 m при 20° C
- регулируема продължителност: от пригл. 5 сек до 12 мин
- регулиране на яркостта на осветлението: от пригл. 5 до 200 лукса
- работна температура: от 0° C до +40° C
- не е подходящо за инсталиране в конзоли с дълбочина 45 mm и конзоли за външен монтаж CUBO IP20
- само за използване на закрито



IR SWITCH 5A 230V~ 2M

- IR infrared switch
- supply voltage: 230V~ ±10 % 50Hz
- relay: 5A / 250V~ (zero crossing)
- protection rating: IP40
- cross-section of wires at the contact terminal: 0.75 - 2.5 mm²
- detection angle: up to 110° at 20°C
- detection area: approx. 8 m at 20°C
- adjustability of duration: from approx. 5 s to 12 min
- adjustability of brightness: from approx. 5 to 200 LUX
- operating temperature: from 0°C to +40°C
- not suitable for installation in 45 mm deep boxes and surface mount box CUBO IP20
- only for indoor usage

обхват на откриване /
detection range

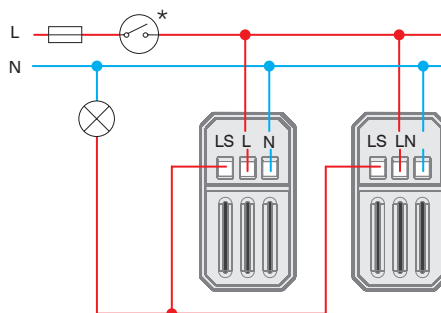
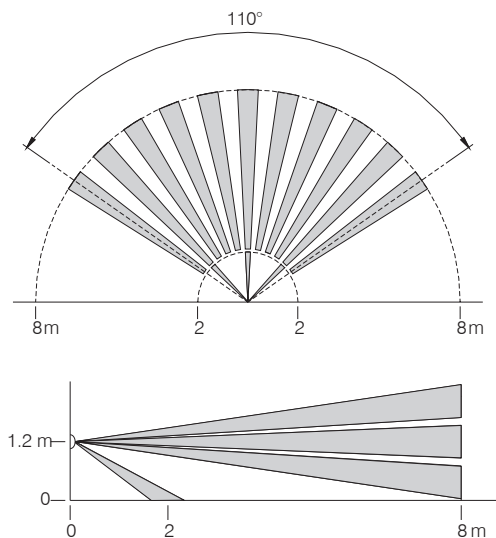

настройка на времето и осветеността C
time and twilight adjustment

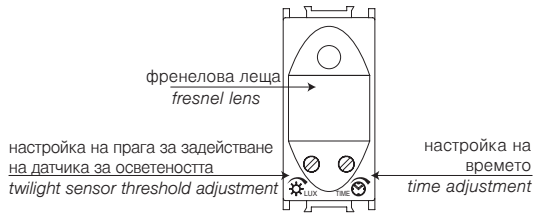

	~5 s	~12 min

	1	2	3	4	5	6	7	8
Min.	1 W	1 W		1 VA	1 W	1 W	1 VA	1 VA
Max.	800 W	800 W	5A	6x20 VA	6x36 W	4x36 W (20μF)	6x23 VA	6x20 VA

- 1 – лампа с нажежаема жичка / incandescent lamp
- 2 – халогенна лампа / halogen lamp
- 3 – съпротивителен нагревателен елемент / resistive heating element
- 4 – електронен преобразовател / electronic transformer
- 5 – флуоресцентна пура (версия 1) / fluorescent tube (version 1)
- 6 – флуоресцентна пура (версия 2) / fluorescent tube (version 2)
- 7 – енергоспестяваща газоразрядна лампа / energy saving CFL lamp
- 8 – светодиодна лампа / LED lamp

внимание/
attention

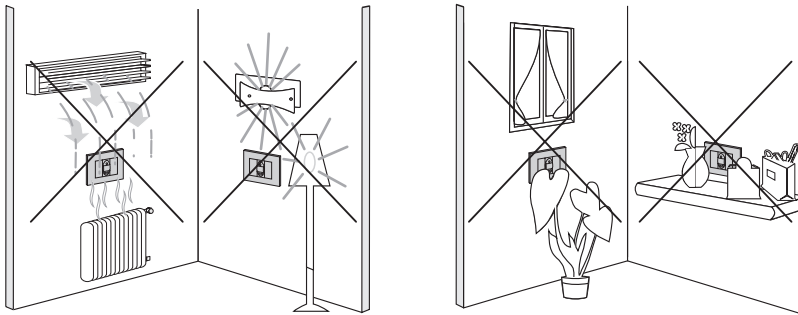

1M = 22,5 x 45

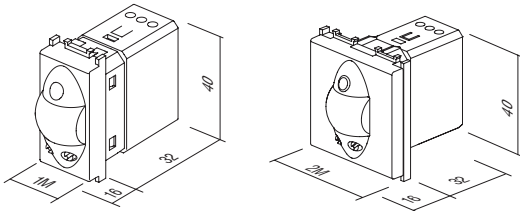

ТЕРМОСТАТ ОСНОВЕН 6A 230V~ 2M



- EM37PW
- EM37SB
- EM37AT
- EM37ES
- EM37IW

- електронен термостат, базов
- работен режим: отопление/охлаждане/изключване
- захранващо напрежение: 230 VAC, 50 Hz
- изход: 6(2) A, 230 VAC, релейен ключ
- обхват на регулиране: +10° C до +30° C
- хистерезис: ±0,5° C, ED = 20 мин
- защита против замръзване (режим на отопление): +6° C
- защита против прегряване (режим на охлаждане): +32° C
- функция ECO за намаляване на температурата с 3° C за 6 часа в режим на отопление и повишаване на температурата с 3° C за 6 часа в режим на охлаждане
- адаптивна функция ECO function, ежедневно автоматично в едно и също време намаляване на температурата с 3° C за 6 часа в режим на отопление и повишаване на температурата с 3° C за 6 часа в режим на охлаждане
- опция за включване на работния режим ECO чрез външно задействане по отделен вход
- светодиодна индикация за режима на работа
- не е подходящо за електрическо подово отопление
- винтови контакти макс. 2,5 mm²
- в съответствие с Директивата за ниско напрежение, Директивата за EMC, стандарти EN60730-1 и EN60730-2-9
- за правилно функциониране препоръчваме да се инсталира в единична отделна конзола, отделно от устройствата, излъчващи топлина
- работна температура: 5 ÷ 35° C
- температура на съхраняване: -20 ÷ 50° C



Термостатът е предназначен за регулиране на температурата в помещението. Термостатът предоставя два работни режима – отопление или охлаждане. Той има инсталирани функции за безопасност – за защита против замръзване (режим на отопление) и - защита против прегряване (режим на охлаждане). Индикацията за действието му е чрез светодиоди. Настройката на термостата се осъществява с въртящ се регулатор за задаване на температурата и с други сензорни капацитивни бутони.

The thermostat is intended for regulating temperature in a room. A thermostat enables two modes of operation – heating or cooling. It has safety functions installed for protection against freezing (heating mode) and protection against overheating (cooling mode). The operation is indicated via LED lights. Thermostat setup is performed with the help of a rotary button for setting the temperature and with other capacitive touch buttons.

THERMOSTAT BASIC 6A 230 V ~ 2M

- electronic thermostat, basic
- operation mode: heating/cooling/turn off
- power supply: 230 VAC, 50 Hz
- output: 6(2) A, 230 VAC, relay switch
- regulation range: +10 °C to +30 °C
- hysteresis: ±0.5 °C, ED = 20min
- anti-freeze protection (heating mode): +6 °C
- overheating protection (cooling mode): +32 °C
- ECO function for lowering the temperature by 3 °C for 6 hours in the heating mode and raising temperature by 3 °C for 6 hours in the cooling mode
- adaptive ECO function, automatically every day at the same time lowers the temperature by 3 °C for 6 hours in the heating mode and raises temperature by 3 °C for 6 hours in the cooling mode
- option to turn on the ECO operating mode by external trigger via a separate input
- LED indication of operation
- not suitable for electrical floor heating
- screw contacts max. 2.5 mm²
- in accordance with the LV Directive, the EMC Directive, standards EN60730-1 and EN60730-2-9
- for correct operation, we recommend installing in an independent single box, separate from devices that generate heat
- operating temperature: 5 ÷ 35 °C
- storage temperature: -20 ÷ 50 °C

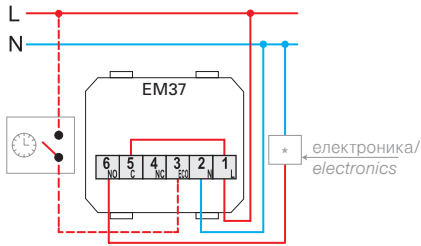

циркуляционна помпа, горелка (директно свързване), термоелектрическо задвижване/
circulation pump, burner (direct connection)
thermoelectric drive

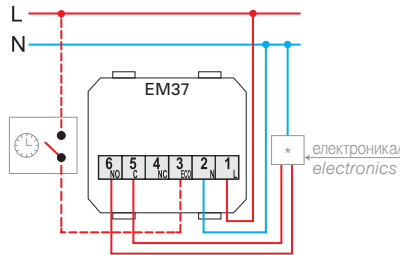

бойлер, помпа за отоплението, горелка (управляващ вход T1/T2) /
boiler, heat pump, burner (control input T1/T2)

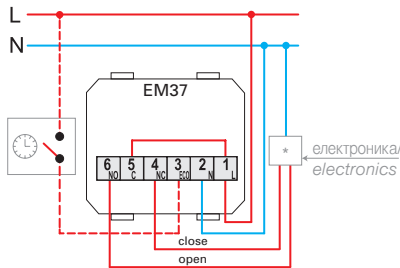

задвижване с мотор (ограничено използване с подово отопление) /
motor drive (limited use with underfloor heating)

настройка на функцията и температурата
function and temperature adjustment

бутон за избиране на функция и светодиоден индикатор за състоянието:
червен: отопление
син: климатизация
без светещ индикатор: изключено

function selection button and LED status indicator:
red: heating
blue: air conditioning
no light: switched off

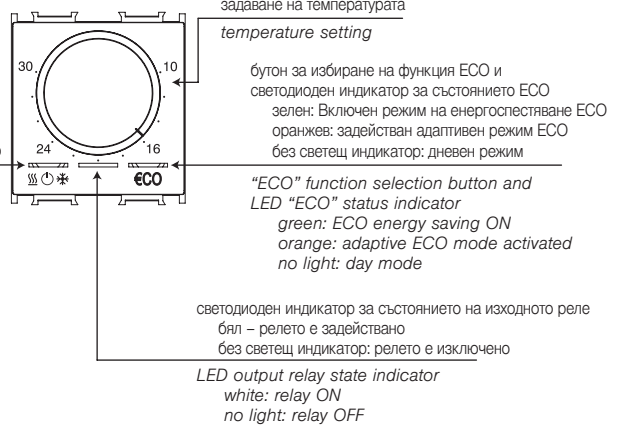

внимание/
attention

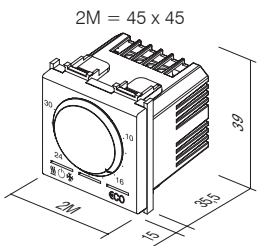
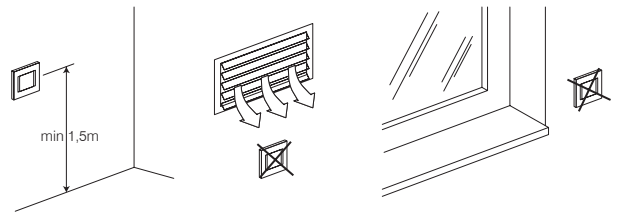

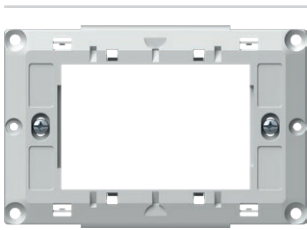

NM39

МОНТАЖНА РАМКА С ВИНТОВЕ ЗА ТЕРМОСТАТИ FANTINI COSMI 3M

- монтажна рамка с винтове за термостати Fantini Cosmi 3M
- подходяща за използване с моделите едноквартни термостати Fantini Cosmi CH121 и CH123
- подходяща за използване с моделите едноседмични термостати Fantini Cosmi CH141A и CH143A
- за монтаж в правоъгълни конзоли 3M
- подходящо за сглобяване с панели PURE, Line, Soft



MOUNTING FRAME WITH SCREWS FOR FANTINI COSMI THERMOSTATS 3M

- mounting frame with screws for Fantini Cosmi thermostats 3M
- suitable for use with Fantini Cosmi daily thermostats models CH121 and CH123
- suitable for use with Fantini Cosmi weekly thermostats models CH141A and CH143A
- for mounting in rectangular boxes 3M
- suitable for assembling with cover plates PURE, Line, Soft



- EM40PW
- EM40SB
- EM40AT
- EM40ES
- EM40IW

КЛЮЧ С КАРТА ЗА ИКОНОМИЯ НА ЕНЕРГИЯ ЗА 250V ~ 3M

- ключ с карта, базов, всякаква ISO карта
- захранващо напрежение 230 V~ 50 Hz
- изход 3 A 250 V~ за комутационния контактор *
- закъснение при изключване 15-20 сек
- в съответствие с EN 61000-6-1
- картата не е включена в доставката
- не е предназначено за контрол на достъпа



ENERGY SAVER CARD SWITCH 3A 250V~ 3M

- card switch basic, any ISO card
- supply voltage 230V~ 50Hz
- output 3A 250V~ for switching contactor *
- switch off delay 15-20s
- in accordance with EN 61000-6-1
- card is not included
- not for access control

3M = 67,5 x 45

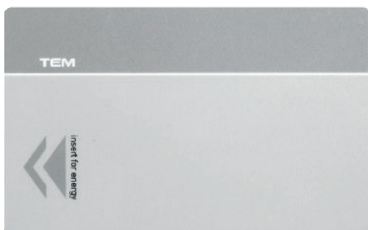
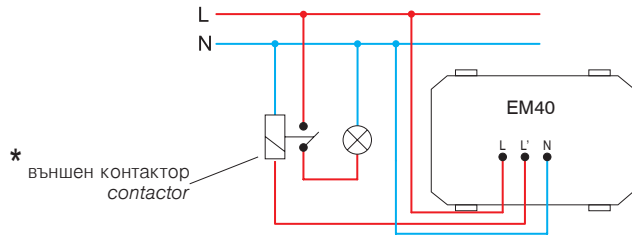
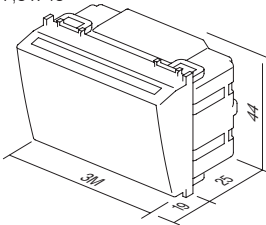

EM47

КАРТА ISO

- карта ISO
- за комбинация с ключ с карта EM40
- размер: 85x54 mm

CARD ISO

- ISO card
- for combination with card switch EM40
- size: 85x54 mm



EM44BK

КЛЮЧ С КАРТА ЗА ИКОНОМИЯ НА ЕНЕРГИЯ RF HF 13,56 MHz 3M

- електронен ключ с карта за RFID ISO карта
- захранва се от релейно устройство EM49 по кабел конектори тип RJ12
- изходът трябва да се свързва с изхода на релейно устройство EM49
- закъснение при изключване на „главното захранване“ 15-20 сек. при изваждане на картата
- закъснение 1 мин. при изключване на „HVAC“ (Отопление, вентилация и климатизация) при изваждане на картата, когато се отворят врати на балкон или прозорец
- в съответствие с EN 61000-6-1
- картата не е включена в доставката
- не е предназначено за контрол на достъпа

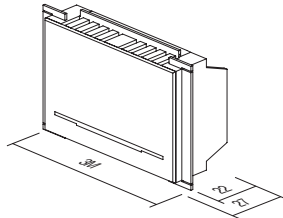

ENERGY SAVER CARD SWITCH RF HF 13,56MHz 3M

- electronic card switch for RFID ISO card
- supply from relay unit EM49 through cable connectors RJ12
- output to be connected to relay output unit EM49
- 15-20s "main power" switch off delay with card withdrawal
- 1 min "HVAC" switch off delay with card withdrawal when balcony doors or windows opened
- in accordance with EN 61000-6-1
- card is not included
- not for access control

УСТРОЙСТВО ЗА УПРАВЛЕНИЕ ЗА ИКОНОМИЯ НА ЕНЕРГИЯ 2x16 A 250 V ~

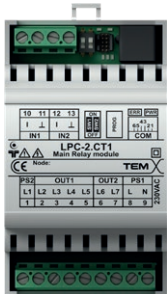

EM49

- релейно устройство за ключове с карта EM44
- захранващо напрежение 230 V ~ 50 Hz
- в съответствие с EN 61000-6-1
- за монтаж върху DIN релса 35 mm, 3 MU
- входът и изходът зависят от реализацията: единична или двойна стая

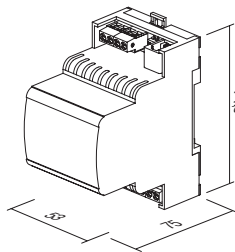

ENERGY SAVER CONTROL UNIT 2x16A 250V~

- relay unit for card switches EM44
- supply voltage 230V~ 50Hz
- in accordance with EN 61000-6-1
- mounting on DIN rail 35mm, 3MU
- input and output depending on implementation: single or double room

РАЗПРЕДЕЛИТЕЛ SPL-1

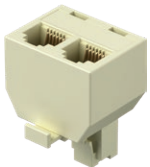

EM45

- служи за свързване на два периферни модула EM44 към релейно устройство EM49
- комуникационен конектор тип RJ12
- размер: 37 x 30 x 27 mm

SPLITTER SPL-1

- used to connect two peripheral modules EM44 to relay unit EM49
- communication connector RJ12
- size: 37 x 30 x 27 mm

схема на свързване при реализация за единична стая / wiring diagram for single room implementation

схема на свързване при реализация за двойна стая / wiring diagram for double room implementation

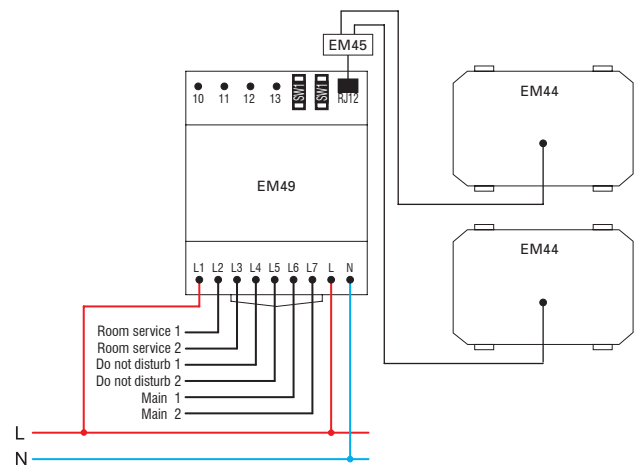
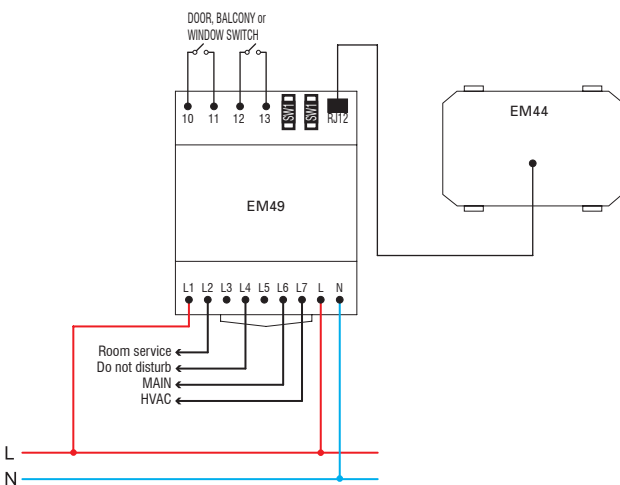

съединителен кабел RJ12 между EM44 и EM49 / connection cable RJ12 between EM44 and EM49

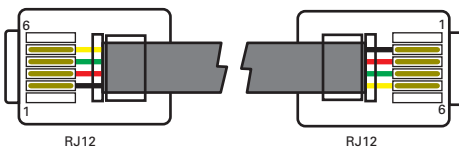



- EM60PW
- EM60SB
- EM60AT
- EM60ES
- EM60IW

КОНТАКТ ЗА САМОБРЪСНАЧКА 230 V~/120 V~ 3M

- захранващо устройство с разделителен трансформатор 20 VA
- захранване: 230 V~ 50-60 Hz
- изход:
 - 230 V~ за 2P 2,5 A Europlug или
 - 120 V~ за 2P 15 A Американски щепсел
- клас II
- в съответствие с EN 61558-2-5

SOCKET SHAVER 230V~/120V~ 3M

- shaver supply unit with isolating transformer 20VA
- supply: 230V~ 50-60Hz
- output:
 - 230V~ for 2P 2.5A Europlug or
 - 120V~ for 2P 15A American plug
- Class II
- in accordance with EN 61558-2-5

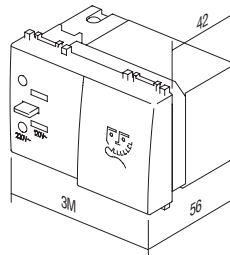

3M = 67,5 x 45

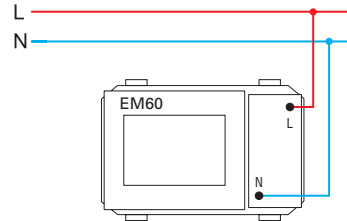

- EM66PW
- EM66SB
- EM66AT
- EM66ES
- EM66IW

USB ЗАХРАНВАЩО УСТРОЙСТВО 5 V 2,1 A 1M

- за зареждане на електронни устройства от стандартен USB порт (съвместим и с устройства от Apple)
- захранване: 100-230 V~ 50/60 Hz
- консумация: 300 mA при 100 V~/150 mA при 230 V~
- консумация в режим на готовност: 30mW при 230 V~
- номинално изходно напрежение: 5 VDC ($\pm 5\%$) SELV (безопасно ниско напрежение)
- напрежение на пулсациите на изхода: 150 mV
- номинален изходен ток: 2.1 A (1 x 2,100 mA) ($\pm 10\%$)
- КПД: максимално 77 %
- работна температура: 0° C/+45° C (само за използване на закрито)
- клас на IP защита: IP20, само за използване на закрито
- устройство клас II
- категория за превишаване на напрежение (EN 62109): клас III
- винтови контакти: макс. 2.5 mm²
- устройство с разстояние между контактите най-малко 3 mm
- в съответствие с EN 60950-1 и директивите за устройства за ниско напрежение и EMC

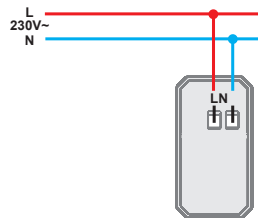
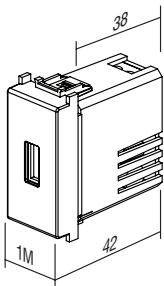

USB POWER SUPPLY UNIT 5V 2,1A 1M

- for charging of electronic devices via a standard USB port (also compatible with Apple devices)
- power supply: 100-230V~ 50/60Hz
- power consumption: 300mA at 100V~/150mA at 230V~
- standby power consumption: 30mW at 230V~
- nominal output voltage: 5 VDC ($\pm 5\%$) SELV
- output ripple voltage: 150mV
- nominal output current: 2,1A (1 x 2.100mA) ($\pm 10\%$)
- efficiency: maximum of 77%
- operating temperature: 0°C/+45°C (indoor use)
- IP protection class: IP20, indoor use only
- class device II
- overvoltage category (EN 62109): Class III
- screw contacts: max. 2.5 mm²
- device with a contact gap of at least 3mm
- in accordance with EN 60950-1 and LVD & EMC directives

USB ЗАХРАНВАЩО УСТРОЙСТВО 5 V 2,4 A 1M

- за зареждане на електронни устройства от стандартен USB порт (съвместим и с устройства от Apple)
- захранване: 100-230 V~ 50/60 Hz
- консумация: 300 mA при 100 V~/150 mA при 230 V~
- консумация в режим на готовност: 30mW при 230 V~
- номинално изходно напрежение: 5 VDC ($\pm 5\%$) SELV (безопасно ниско напрежение)
- напрежение на пулсациите на изхода: 150 mV
- номинален изходен ток: 2.4 A ($\pm 10\%$)
- КПД: максимално 77 %
- работна температура: 0° C/+45° C (само за използване на закрито)
- клас на IP защита: IP20, само за използване на закрито
- устройство клас II
- категория за превишаване на напрежение (EN 62109): клас III
- винтови контакти: макс. 2.5 mm²
- устройство с разстояние между контактите най-малко 3 mm
- в съответствие с EN 60950-1 и директивите за устройства за ниско напрежение и EMC



- EM67PW
- EM67SB
- EM67AT
- EM67ES
- EM67IW

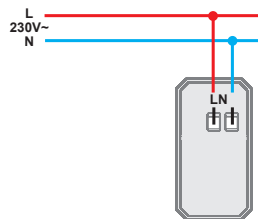
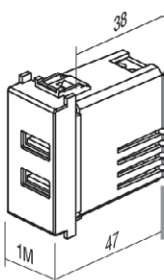

USB POWER SUPPLY UNIT 5V 2,4A 1M

- for charging of electronic devices via a standard USB port (also compatible with Apple devices)
- power supply: 100-230V~ 50/60Hz
- power consumption: 300mA at 100V~/150mA at 230V~
- standby power consumption: 30mW at 230V~
- nominal output voltage: 5 VDC ($\pm 5\%$) SELV
- output ripple voltage: 150mV
- nominal output current: 2,4A ($\pm 10\%$)
- efficiency: maximum of 77%
- operating temperature: 0°C/+45°C (indoor use)
- IP protection class: IP20, indoor use only
- class device II
- overvoltage category (EN 62109): Class III
- screw contacts: max. 2.5 mm²
- device with a contact gap of at least 3mm
- in accordance with EN 60950-1 and LVD & EMC directives



- EM68PW
- EM68SB
- EM68AT
- EM68ES
- EM68IW

USB ЗАХРАНВАЩ БЛОК 5V 3,0A

- за зареждане на електронни устройства чрез стандартен USB порт (съвместим с устройства на Apple)
- захранване: 100-230V~ 50/60Hz
- консумация на енергия: 300mA при 100V~/150mA при 230V~
- консумация на енергия в режим на готовност: 30mW при 230V~
- номинално изходно напрежение: 5 VCD (± 5%) SELV
- изходно напрежение на пулсации: 150 mV
- номинален изходен ток: 3,0 A (±10%)
- вид конектор: USB A/USB C
- ефективност: максимум 77%
- температура на работа: 0°C/+45°C (за употреба в затворени пространства)
- Клас на IP защита: IP20, само за употреба в затворени пространства
- устройство клас II
- категория свръхнапрежение (EN 62109): Клас III
- контакти с винтови клеми: макс. 2,5 mm²
- устройство с контактна междина най-малко 3 mm
- в съответствие с Директива EN 60950-1 и Директива за безопасност на нисковолтови електрически съоръжения (LVD) и Директива относно електромагнитна съвместимост (EMC)

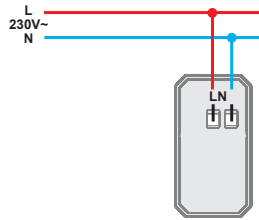
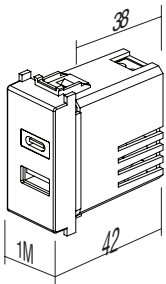

USB POWER SUPPLY UNIT 5V 3,0A

- for charging of electronic devices via a standard USB port (also compatible with Apple devices)
- power supply: 100-230V~ 50/60Hz
- power consumption: 300mA at 100V~/150mA at 230V~
- standby power consumption: 30mW at 230V~
- nominal output voltage: 5 VCD (± 5%) SELV
- output ripple voltage: 150mV
- nominal output current: 3,0 A (±10%)
- connector type: USB A / USB C
- efficiency: maximum of 77%
- operating temperature: 0°C/+45°C (indoor use)
- IP protection class: IP20, indoor use only
- class device II
- overvoltage category (EN 62109): Class III
- screw contacts: max. 2.5 mm²
- device with a contact gap of at least 3mm
- in accordance with EN 60950-1 and LVD & EMC directives

СВЕТОДИОДНО АВАРИЙНО ОСВЕТЛЕНИЕ 250 V~ 0,90 W, NiCd 3h 7M



□ EM55

- светодиодна лампа за аварийно осветление
- захранващо напрежение 250 V~ 50 Hz 3 x LED 0,3 W, 10000 mcd, 6500 K
- NiCd акумулатор 400 mAh, позволяващ смяна
- автономно действие 3 часа, зареждане 24 часа
- клас II
- в съответствие с EN 60598-1, EN 60598-2-2, EN 60598-2-22



LED EMERGENCY LIGHT 250V~ 0.90W, NiCd 3h 7M

- emergency LED lamp
- supply voltage 250V~ 50Hz 3x LED 0,3W, 10000mcd, 6500K
- NiCd accumulator 400 mAh, replaceable
- autonomy 3h, charging 24h
- Class II
- in accordance with EN 60598-1, EN 60598-2-2, EN 60598-2-22

7M = 151,5 x 45

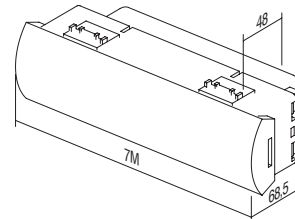
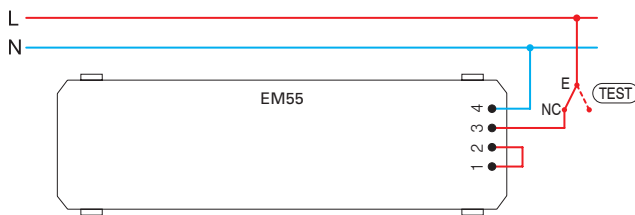

АВАРИЙНА СВЕТОДИОДНА ЛАМПА 230V~50 Hz, 0,5 W, NiMH 2h 2M



EM57

- аварийна светодиодна лампа
- с опция за употреба и като ръчна лампа (издърпващ се механизъм)
- захранващо напрежение 230 V~ 50 Hz, 1xLED 0,5 W
- Акумулаторна NiMH батерия 140 mAh, сменяема
- автономна работа 2 часа, зареждане 36 часа
- устройство клас II
- в съответствие с EN60598-1, EN60598-2-2, EN62471, EN55015:2006, EN61547

LED EMERGENCY LIGHT 230V~50Hz, 0.5W, NiMH 2h 2M

- emergency LED lamp
- option to use it as a hand lamp (pull-out mechanism)
- supply voltage 230V~ 50Hz, 1xLED 0.5W
- NiMH accumulator 140mAh, replaceable
- autonomy 2h, charging 36h
- class device II
- in accordance EN60598-1, EN60598-2-2, EN62471, EN55015:2006, EN61547

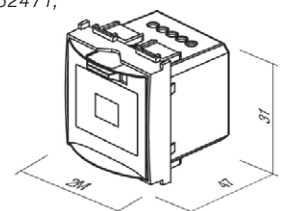
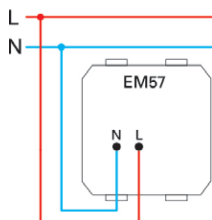
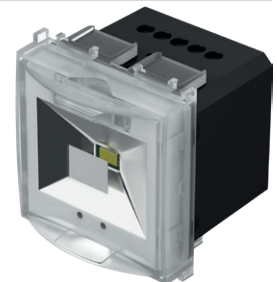

ЕДНОЦВЕТНА СВЕТОДИОДНА ЛАМПА 250 V~ 0,8 W 2M

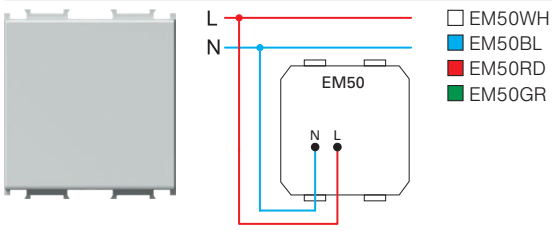

- светодиодна лампа за обозначаване на стъпала
- захранващо напрежение 230 V~ 50 Hz 0,8 W, 6500 K
- клас II
- в съответствие с EN 60598-1
- възможно е да се използва за осветяване на знаци за сигнализация и упътване с отпечатване на текст по желание на клиента с лазерен печат върху дифузора

LED LAMP MONOCOLOR 250V~ 0,8W 2M

- step marker LED lamp
- supply voltage 230V~ 50Hz 0,8W, 6500K
- Class II
- in accordance with EN 60598-1
- optional usage for directional or signal illumination with customized laser printing on diffuser



ДВУЦВЕТНА СВЕТОДИОДНА ЛАМПА 250 V~ 2 x 0,4 W 2M

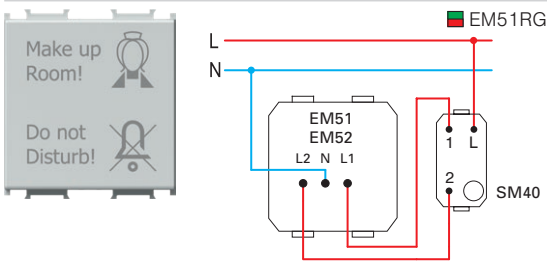

- светодиодна лампа с двоен сигнален цвят (червен/зелен)
- захранващо напрежение 230 V~ 50 Hz 2 x 0,4 W, 6500 K
- клас II
- в съответствие с EN 60598-1
- върху дифузора има графично изображение, както е показано
- възможно е отпечатване по желание на клиента с лазерен печат върху дифузора

LED LAMP DUAL COLOR 250V~ 2x0,4W 2M

- signaling dual color (red/green) LED lamp
- supply voltage 230V~ 50Hz 2x0,4W, 6500K
- Class II
- in accordance with EN 60598-1
- diffuser includes graphics as shown
- possible customized laser printing on diffuser



ДВУЦВЕТНА СВЕТОДИОДНА 3D ЛАМПА 250 V~ 2 x 0,4 W 2M

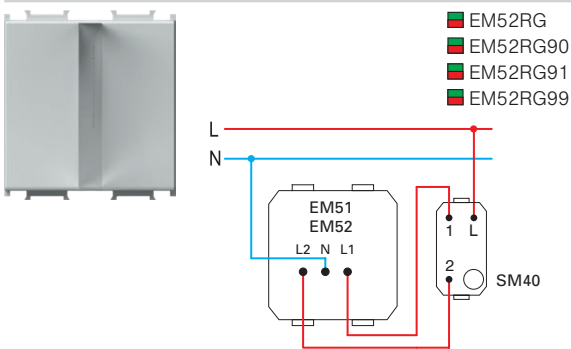

- сигнална светодиодна лампа, два цвята (червен/зелен) с 3D символ
- захранващо напрежение 230 V~ 50 Hz 2 x 0,4 W, 6500 K
- клас II
- в съответствие с EN 60598-1
- възможно е отпечатване на графично изображения по желание на клиента
- 90 символ „Мъже“, 91 символ „Жени“, 99 символ по поръчка

LED LAMP 3D DUAL COLOR 250V~ 2x0,4W 2M

- signalling LED lamp, dual color (red/green) with 3D symbol
- supply voltage 230V~ 50Hz 2x0,4W, 6500K
- class II
- in accordance with EN 60598-1
- possible customized graphics on request
- 90 male symbol, 91 female symbol, 99 symbol on request

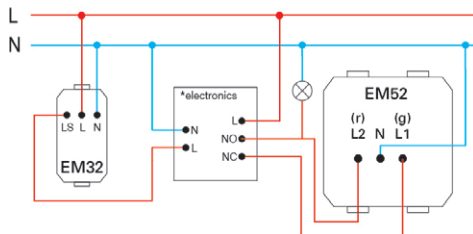
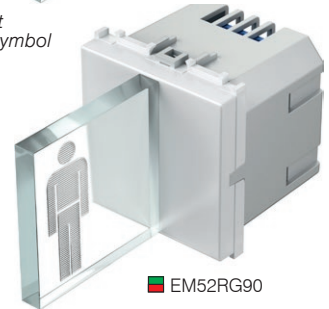
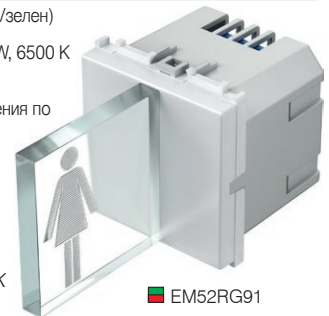

2M = 45 x 45

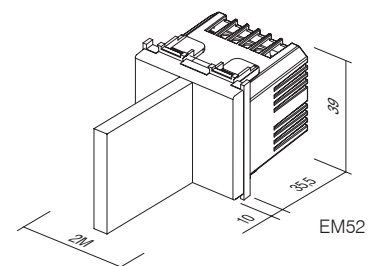
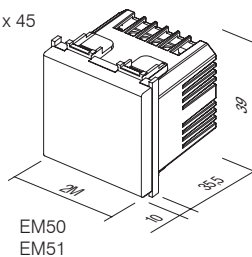



- EM71PW
- EM71SB
- EM71AT
- EM71ES
- EM71IW

ПРЕВКЛЮЧАТЕЛ С ПРЪСТОВ ОТПЕЧАТЪК BIOPASS 2M

- Превключвател с пръстов отпечатък с включен вътрешен релейен модул и захранване
- Капацитет: 500 пръстови отпечатъка
- Лесно управление чрез мобилното приложение X-Manager
- Захранващо напрежение: 8 – 30 V – DC или AC (с включено захранване)
- Капацитивен сензор
- 2 изходни релета
- Максимално напрежение/ток в релето: 40 V/3 A
- Време за задействане на релето: 1 – 10 сек
- Максимална мощност: 3,6 W
- 256-битова шифрована връзка между превключвателя и вътрешния релейен модул
- Комплект с включени NM24 монтажна рамка и OS20 декоративна рамка.

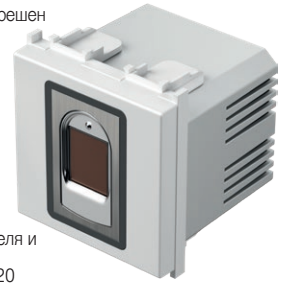

FINGERPRINT SWITCH BIOPASS 2M

- fingerprint switch with included internal relay unit and power supply
- capacity: 500 fingerprints
- easy management via X-Manager mobile app
- power supply voltage: 8-30V – DC or AC (power supply included)
- capacitive sensor
- 2 output relays
- maximum voltage/current on relay: 40V/3A
- relay triggering time: 1-10 sec
- maximum power: 3.6W
- 256-bit encrypted link between switch and internal relay unit
- Set also includes NM24 mounting frame and OS20 decorative cover plate.

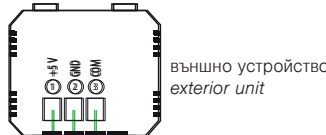
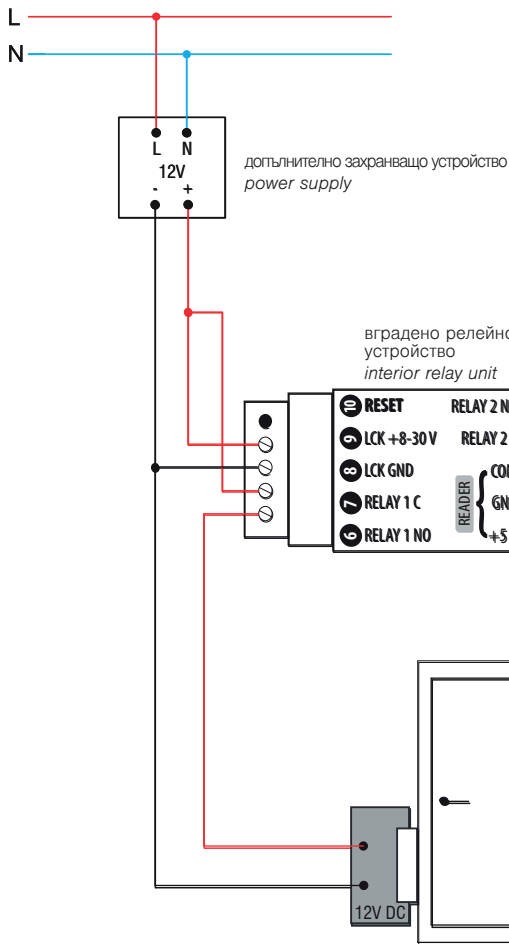

X-Manager app



support.tem.si



електрическа ключалка electric lock

външно устройство exterior unit

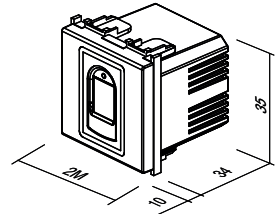

БЕЗКОНТАКТЕН КЛЮЧ, 10 A 240 V~



EM80GW

- безконтактен ключ за включване/изключване („главен“)
- захранване: 240 V~ 50 Hz
- релеен изход 10 A/250 V~ (2400 W при 240 V~)
- регулируем диапазон 2 до 10 cm
- предназначен е за инсталиране в стандартна кръгла конзола Ø60 mm
- за свързването се изисква проводник за неутралата (N)
- не е възможно свързване с двупосочен ключ
- възможно е свързване с до 5 ключа за управление EM81
- лесно инсталиране на декоративни капаци с помощта на магнити
- винтово захващане на проводници със сечение до 2,5 mm² (макс. въртящ момент за притягане 0,4 Nm)
- в съответствие с EN 60669-1 и EN 60669-2-1
- само за използване на закрито



SWITCH, TOUCHLESS 10A 240V~

- touchless switch for turning on/off ("master")
- power supply: 240 V~ 50 Hz
- output relay 10A / 250V~ (2400W at 240V~)
- adjustable range from 2 to 10 cm
- intended for installation into a standard round Ø60 mm box
- a neutral lead (N) is required for connection
- connection with toggle switches is not possible
- connection with up to 5 EM81 control switches is possible
- simple installation of decorative covers with the help of magnets
- screw fastening of leads up to 2.5 mm² (max. screw tightening torque is 0.4 Nm)
- in accordance with EN 60669-1 and EN 60669-2-1
- only for indoor use

БЕЗКОНТАКТЕН КЛЮЧ, УСТРОЙСТВО ЗА УПРАВЛЕНИЕ



EM81GW

- ключ за управление („подчинен“)
- функционира само при свързване с ключ EM80 („главен“)
- регулируем диапазон 2 до 10 cm
- лесно инсталиране на декоративни капаци с помощта на магнити
- винтово захващане на проводници със сечение до 2,5 mm² (макс. въртящ момент за притягане е 0,4 Nm)
- в съответствие с EN 60669-1 и EN 60669-2-1
- само за използване на закрито

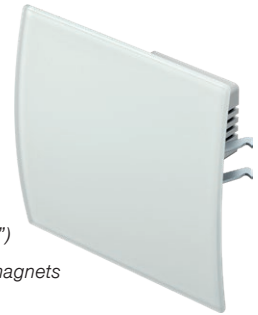

SWITCH, TOUCHLESS, CONTROL UNIT

- control switch ("slave")
- works only when connected with the EM80 switch ("master")
- adjustable range from 2 to 10 cm
- simple installation of decorative covers with the help of magnets
- screw fastening of leads up to 2.5 mm² (max. screw tightening torque is 0.4 Nm)
- in accordance with EN 60669-1 and EN 60669-2-1
- only for indoor use

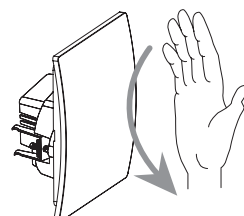
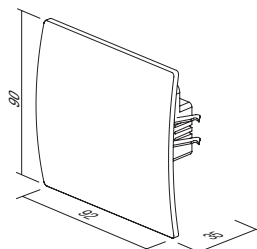
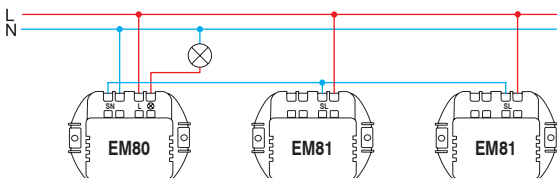
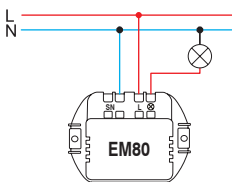

ЗУМЕР 8 VA 230 V~1M

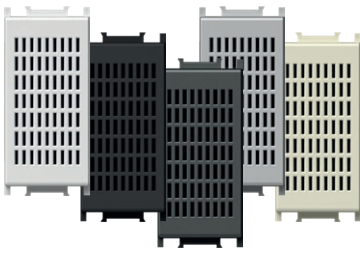

- EM90PW
- EM90SB
- EM90AT
- EM90ES
- EM90IW

- сигнален зумер
- издаването на звук продължава колкото управляващото действие
- захранващо напрежение 230 V ~ 50 Hz 8 VA

BUZZER 8VA 230V~1M

- signal buzzer
- the sound emission has the same lasting time as the control operation
- supply voltage 230V~ 50Hz 8VA



ЗУМЕР 8 VA 12 V~1M

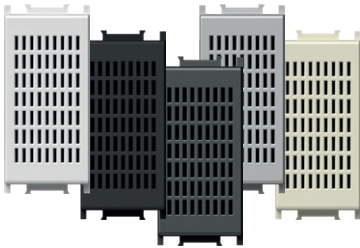

- EM91PW
- EM91SB
- EM91AT
- EM91ES
- EM91IW

- сигнален зумер
- издаването на звук продължава колкото управляващото действие
- захранващо напрежение 12 V~ 50 Hz 8 VA

BUZZER 8VA 12V~1M

- signal buzzer
- the sound emission has the same lasting time as the control operation
- supply voltage 12V~ 50Hz 8VA



ЗВЪНЕЦ 8 VA 230 V~1M

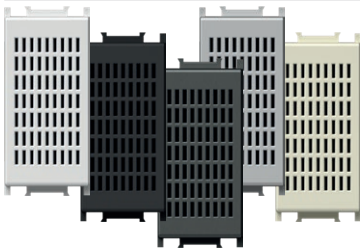

- EM92PW
- EM92SB
- EM92AT
- EM92ES
- EM92IW

- сигнален звънец
- издаването на звук продължава колкото управляващото действие
- захранващо напрежение 230 V~ 50 Hz 8 VA

BELL 8VA 230V~1M

- signal bell
- the sound emission has the same lasting time as the control operation
- supply voltage 230V~ 50Hz 8VA



ЗВЪНЕЦ 8 VA 12V~1M

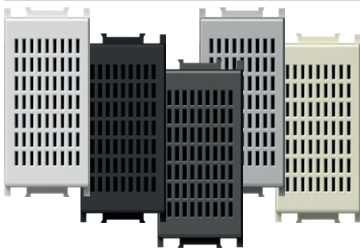

- EM93PW
- EM93SB
- EM93AT
- EM93ES
- EM93IW

- сигнален звънец
- издаването на звук продължава колкото управляващото действие
- захранващо напрежение 12 V~ 50 Hz 8 VA

BELL 8VA 12V~1M

- signal bell
- the sound emission has the same lasting time as the control operation
- supply voltage 12V~ 50Hz 8VA

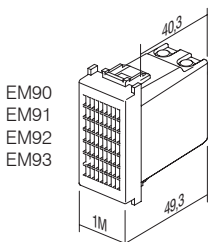

EM90
EM91
EM92
EM93

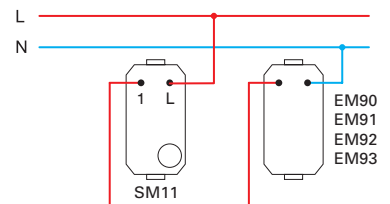

EM90
EM91
EM92
EM93

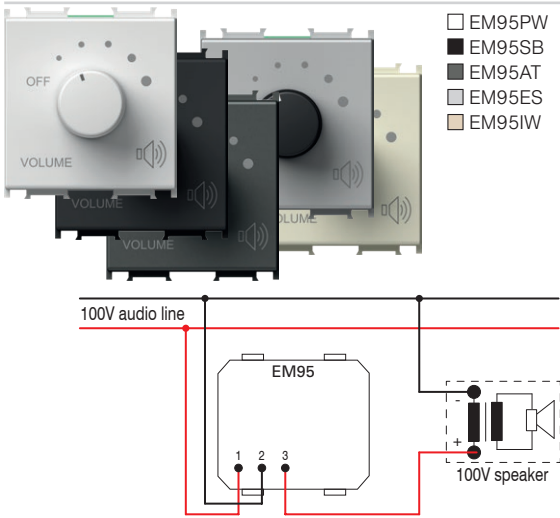

РЕГУЛАТОР НА СИЛАТА НА ЗВУКА 100 V AUDIO LINE 35 W 2M

- регулатор на силата на звука (атенюатор) за аудиосистеми 100 V
- номинална мощност 35 W (макс. 45 W), 6 нива регулиране на силата на звука
- подходящо за инсталиране в конзоли (с мин. дълбочина 60 mm)
- не е подходящо за инсталиране в конзоли с дълбочина 45 mm и конзоли за външен монтаж CUBO IP20
- само за използване на закрито

VOLUME CONTROL 100V AUDIO LINE 35W 2M

- volume control (attenuator) for 100V audio systems
- power rating 35W (max.45W), 6 steps volume control
- suitable for boxes min. 60 mm deep
- not suitable for installation in 45 mm deep boxes and surface mount boxes CUBO IP20
- for indoor use only

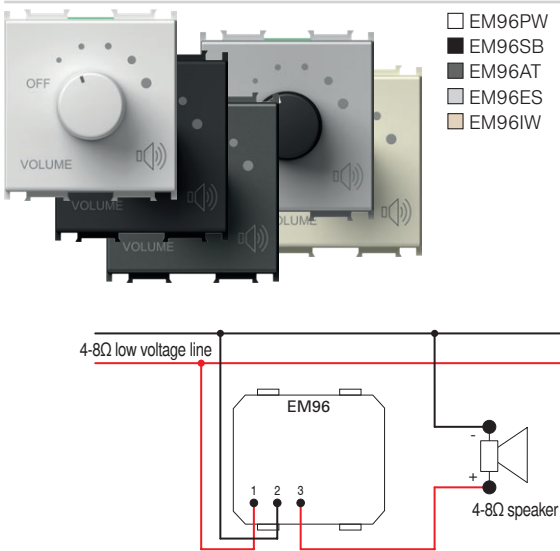

РЕГУЛАТОР НА СИЛАТА НА ЗВУКА 4-8 Ω 35 W 2M

- регулатор на силата на звука (атенюатор) за изходи с ниско напрежение 4-8 Ω, 35 W
- допуска се свързване на HI-FI устройства
- номинална мощност 35 W, 6 нива на регулиране на силата на звука
- подходящо за инсталиране в конзоли (с мин. дълбочина 60 mm)
- не е подходящо за инсталиране в конзоли с дълбочина 45 mm и конзоли за външен монтаж CUBO IP20
- само за използване на закрито

VOLUME CONTROL 4-8 Ω 35W 2M

- volume control (attenuator) for low voltage outputs 4-8 Ω, 35W
- power rating 35W, 6 steps volume control
- suitable for boxes min. 60 mm deep
- not suitable for installation in 45 mm deep boxes and surface mount boxes CUBO IP20
- for indoor use only

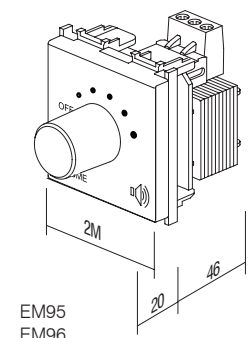

EM95
EM96



CM25

PW

OS

тип type	описание description	технически данни technical data	размер size	цвет colour	допълнителна информация 1 optional data 1
CM10	КОМПЛЕКТ КОНТАКТИ 2xШУКО SOCKET SET 2x SCHUKO	2P+E 16A 250V~	4M	<input type="checkbox"/> PW снежнобял цвят polar white	<input type="checkbox"/> OL панел LINE cover plate LINE
CM11	КОМПЛЕКТ КОНТАКТИ 3xШУКО SOCKET SET 3x SCHUKO	2P+E 16A 250V~	7M	<input checked="" type="checkbox"/> SB сензорен бутон, черен soft touch black	<input type="checkbox"/> OS панел SOFT cover plate SOFT
CM15	КОМПЛЕКТ СЪЕДИНИТЕЛНИ ПРОВОДНИЦИ LINK WIRE SET	3x1.5mm ²	1M	<input checked="" type="checkbox"/> AT антрацит anthracite	
...	<input type="checkbox"/> ES сребрист elox silver	
...	<input type="checkbox"/> IW слонова кост ivory white	

КОМПЛЕКТ КОНТАКТИ 2 x ШУКО 2P+E 16 A 250 V~ 4M

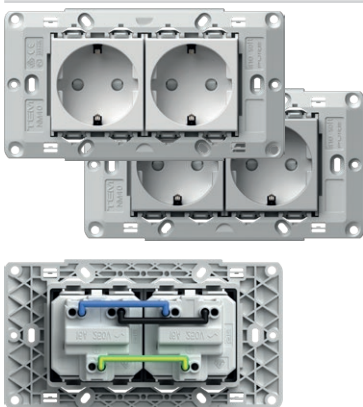

- CM10PW
- CM10ES

- комплект контакти 2 x шуко VM10 2P+E 16 A 250 V~
- предварително свързани съединителни проводници CM16
- с монтажна рамка 4M без винтове
- за закрепване към монтажна рамка използвайте винтове CM17, CM18 или CM19
- винтови контакти 1,5 - 2,5 mm²
- в съответствие с IEC 60884-1, CEE7

SOCKETS SET 2x SCHUKO 2P+E 16A 250V~ 4M

- socket set 2x schuko VM10 2P+E 16A 250V~
- prewired with link wires CM16
- with mounting frame 4M without screws
- for mounting frame fixing use screws CM17, CM18 or CM19
- screw contacts 1.5-2.5 mm²
- in accordance with IEC-60884-1, CEE7

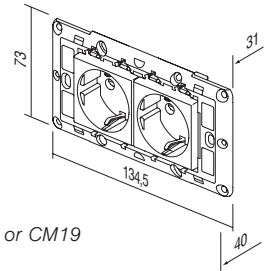

КОМПЛЕКТ КОНТАКТИ 3 x ШУКО 2P+E 16 A 250 V~ 7M

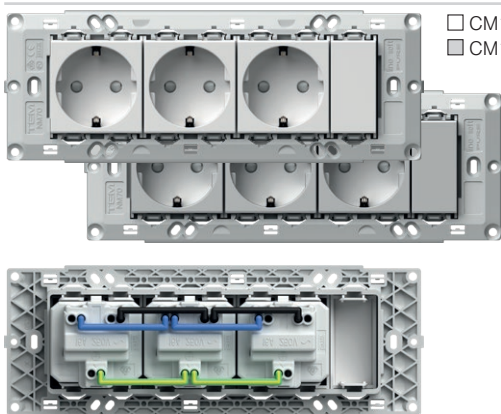

- CM11PW
- CM11ES

- комплект контакти 3 x шуко VM10 2P+E 16 A 250 V~
- предварително свързани съединителни проводници CM16
- с монтажна рамка 7M без винтове
- за закрепване към монтажна рамка използвайте винтове CM17, CM18 или CM19
- винтови контакти 1,5 - 2,5 mm²
- в съответствие с IEC 60884-1, CEE7

SOCKETS SET 3x SCHUKO 2P+E 16A 250V~ 7M

- socket set 3x schuko VM10 2P+E 16A 250V~
- prewired with link wires CM16
- with mounting frame 7M without screws
- for mounting frame fixing use screws CM17, CM18 or CM19
- screw contacts 1.5-2.5 mm²
- in accordance with IEC-60884-1, CEE7

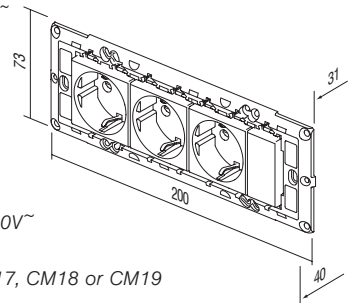

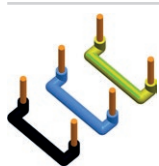

CM15

КОМПЛЕКТ СЪЕДИНИТЕЛНИ ПРОВОДНИЦИ 3 x 1,5 mm², 1M

- комплект съединителни проводници за свързване на два елемента с размер 1M
- съдържа 10 черни, 10 сини и 10 жълти/зелени проводника

LINK WIRE SET 3x1.5mm² 1M

- link wire set to connect two elements size 1M
- includes 10 black, 10 blue and 10 yellow/green wires

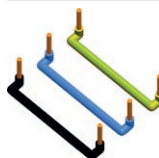
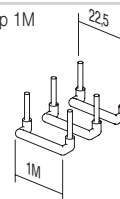

CM16

КОМПЛЕКТ СЪЕДИНИТЕЛНИ ПРОВОДНИЦИ 3 x 2,5 mm², 2M

- комплект съединителни проводници за свързване на два елемента с размер 2M
- съдържа 10 черни, 10 сини и 10 жълти/зелени проводника

LINK WIRE SET 3x2.5mm² 2M

- link wire set to connect two elements size 2M
- includes 10 black, 10 blue and 10 yellow/green wires

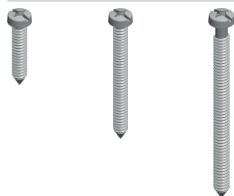
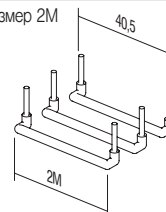

CM17

CM18

CM19

КОМПЛЕКТ ВИНТОВЕ 3,5

- адаптер за закрепване за монтажни рамки NM30, NM32, NM40, NM41, NM70
- CM17 - l=20 mm, 100 бр.
- CM18 - l=35 mm, 50 бр.
- CM19 - l=50mm, 50 бр.

SCREW SET 3,5

- screw set for fixing mounting frames NM30, NM32, NM40, NM41, NM70
- CM17 - l=20mm, 100pcs
- CM18 - l=35mm, 50pcs
- CM19 - l=50mm, 50pcs

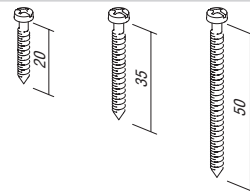

□ CM22PW

КОМПЛЕКТ КЛЮЧОВЕ IP44 2M

- за използване във влажни зони
- защита IP44 може да се постигне за всички ключове Modul
- ключовете и бутоните не са част от комплекта
- панел SOFT 2M с надпис
- в съответствие с IEC 60669-1

SET SWITCHES IP44 2M

- for usage in humid areas
- IP44 protection provides for all Modul switches
- switches and buttons are not part of the set
- SOFT 2M cover plate with inscription plate
- in accordance with IEC 60669-1



□ CM23PW

КОМПЛЕКТ КОНТАКТИ IP44 2M

- за използване във влажни зони
- защита IP44 може да се постигне само в комбинация с покрит контакт (VM11, VM41)
- контактите не са част от комплекта
- панел SOFT 2M с надпис
- в съответствие с IEC 60884-1

SET SOCKETS IP44 2M

- for usage in humid areas
- IP44 protection can be achieved only in combination with covered socket (VM11, VM41)
- sockets are not part of the set
- SOFT 2M cover plate with inscription plate
- in accordance with IEC 60884-1

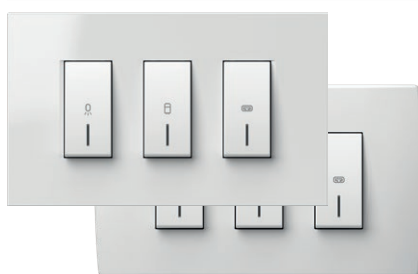

□ CM25PWOL

■ CM25IWOL

□ CM25PWOS

■ CM25IWOS

КОМПЛЕКТ КЛЮЧОВЕ ЗА БАНЯ 3 x 20 A 250 V~ 4M

- комплект ключове 3 x SM12 20 A 250 V~ с монтажна рамка и панел
- винтови контакти 1,5 - 2,5 mm²
- в съответствие с EN 60669-1
- универсално решение за подновяване на конзоли с размери за закрепване 108-135 mm или конзоли размер 4M
- височина на панела 90 mm

SWITCH SET FOR BATHROOM 3x20A 250V~ 4M

- switch set 3xSM12 20A 250V~ with mounting frame and cover plate
- screw contacts 1.5-2.5mm²
- in accordance with EN 60669-1
- universal solution for renovation on boxes with fixing dimensions 108-135mm or boxes 4M size
- cover plate height 90mm

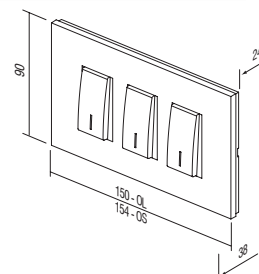

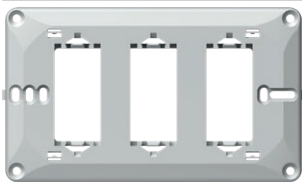

NM41

МОНТАЖНА РАМКА ЗА КОМПЛЕКТ ЗА БАНЯ 4M

- универсална монтажна рамка за комплект за баня с винтове
- универсално решение за монтиране върху правоъгълни конзоли с размери за закрепване 108-135 mm или конзоли размер 4M
- в съответствие с EN 60669-1

MOUNTING FRAME BATHROOM SET 4M

- universal mounting frame for bathroom set with screws
- universal solution for mounting on rectangular boxes with fixing dimensions 108-135mm or boxes 4M size
- in accordance with EN 60669-1

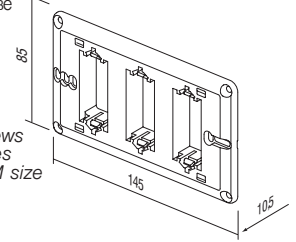

	OL41PW
	OL41NB
	OL41IW
	OL41ES
	OL41SG
	OL41IB
	OL41AT
	OL41TI

ПАНЕЛ LINE ЗА КОМПЛЕКТ ЗА БАНЯ

- декоративен панел LINE за комплект за баня
- височина 90 mm
- в съответствие с EN 60669-1

COVER PLATE LINE BATHROOM SET

- decorative cover plate bathroom set LINE
- height 90mm
- in accordance with EN 60669-1

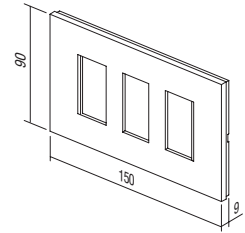

	OS41PW		OS41SB
	OS41NB		OS41WE
	OS41IW		OS41AT
	OS41ES		OS41TI
	OS41SG		

ПАНЕЛ SOFT ЗА КОМПЛЕКТ ЗА БАНЯ



- декоративен панел SOFT за комплект за баня
- височина 90 mm
- в съответствие с EN 60669-1

COVER PLATE SOFT BATHROOM SET

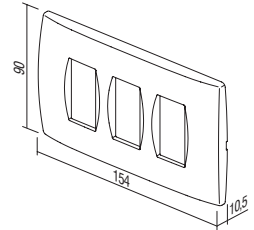
- decorative cover plate bathroom set SOFT
- height 90mm
- in accordance with EN 60669-1





тип type	описание description	размер size	цвет colour	допълнителна информация 1 optional data 1
TM11	БУТОН BUTTON	1M	□ AW антибактериален, бял antibacterial white	 NT неутрален neutral
TM21	КАПАЧЕ BLANK	1M		
VM10	КОНТАКТ SOCKET	2M		 IN индикатор indicator
.	.	.		
.	.	.		

МОДУЛ ЗА АНТИБАКТЕРИАЛНА ПРОГРАМА

- ключовете и контактите всеки ден се докосват от много хора, поради което са общо място за развитие и разпространение на бактерии
- благодарение на естествените си антибактериални свойства, среброто вече три хилядолетия се използва като безопасен и ефикасен дезинфектант, тъй като е напълно естествено, здравословно и не уврежда околната среда
- добавката със специални антибактериални йони осигурява дълготрайно надеждна и ефикасна защита против развитието и разпространението на бактерии, микроби и плесени
- антибактериалната защита осигурява поддържане хигиена, чистота и здраве
- антибактериалната програма MODUL е изключително подходяща за приложение в среда със строги изисквания за хигиена (болници, здравни центрове, фармацевтични обекти, домове за възрастни, приюти, лаборатории, ресторанти, хотели, летища, автобусни и железопътни станции, бизнес и търговски зони, обществени институции...)
- проведени са независими лабораторни изпитвания в съответствие с най-високите японски стандарти JIS Z 2801
- ниски разходи за подобряване на човешкото здраве
- структурата и функционалността на антибактериалната програма MODUL позволяват лесно почистване и поддръжка
- антибактериалните бутони, панели и контакти се комбинират с класически монтажни рамки и ключове
- продуктите са обозначени отзад с AW (антибактериален, бял)

ANTIBACTERIAL PROGRAM MODUL

- switches and sockets are daily touched by many people, so this is a common place for development and spread of bacteria
- thanks to its natural antibacterial characteristics silver has been used for three millennia as a safe and effective disinfectant, since it is completely natural, healthy and environmentally friendly
- special antibacterial silver ions additive provides long-term, reliable and effective protection against the development and spread of bacteria, microbes and fungi
- antibacterial protection ensures hygiene, cleanliness and health for people
- perfectly suitable for use in environments with strict hygiene conditions (hospitals, health centers, pharmaceutical facilities, homes for elderly, nursing homes, laboratories, restaurants, hotels, airports, bus and railway stations, business and shopping areas, public institutions ...)
- independent laboratory testings have been carried out in accordance with highest Japanese standards JIS Z 2801
- low cost for providing human health
- design and functionality of antibacterial program MODUL allow easy cleaning and maintenance
- antibacterial buttons, cover plates and sockets are combined with classic mounting frames and switches
- products are labelled on the back with AW (antibacterial white)

A N T I B A C T E R I A L P R O G R A M M O D U L

БУТОН 1М



□ TM11AW

- сменяем бутон 1М, в съответствие с EN 60669-1
- антибактериална защита в съответствие с изискванията по стандарт JIS Z 2801

BUTTON 1M

- replaceable button 1M
- in accordance with EN 60669-1
- antibacterial protection in accordance with JIS Z 2801



БУТОН 1М С ИНДИКАТОР



□ TM11AWIN

- сменяем бутон 1М, в съответствие с EN 60669-1
- антибактериална защита в съответствие с изискванията по стандарт JIS Z 2801

BUTTON 1M INDICATOR

- replaceable button 1M
- in accordance with EN 60669-1
- antibacterial protection in accordance with JIS Z 2801



БУТОН 2М



□ TM12AW

- сменяем бутон 2М с носач за бутон
- за надграждане на ключ или бутон от размер 1М към размер 2М
- в съответствие с EN 60669-1
- антибактериална защита в съответствие с изискванията по стандарт JIS Z 2801

BUTTON 2M

- replaceable button 2M with button carrier
- to upgrade switch or push button from size 1M to size 2M
- in accordance with EN 60669-1
- antibacterial protection in accordance with JIS Z 2801

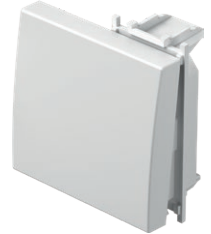

БУТОН 2М С ИНДИКАТОР



□ TM12AWIN

- сменяем бутон 2М с носач за бутон
- за надграждане на ключ или бутон от размер 1М към размер 2М
- в съответствие с EN 60669-1
- антибактериална защита в съответствие с изискванията по стандарт JIS Z 2801

BUTTON 2M INDICATOR

- replaceable button 2M with button carrier
- to upgrade switch or push button from size 1M to size 2M
- in accordance with EN 60669-1
- antibacterial protection in accordance with JIS Z 2801



КАПАЧЕ 1М



□ TM21AW

- модулно капаче за покриване на неизползвани позиции
- в съответствие с EN 60669-1
- антибактериална защита в съответствие с изискванията по стандарт JIS Z 2801

BLANK 1M

- blank modul to fill up empty spaces
- in accordance with EN 60669-1
- antibacterial protection in accordance with JIS Z 2801



КАПАЧЕ 2М



□ TM22AW

- модулно капаче за покриване на неизползвани позиции
- в съответствие с EN 60669-1
- антибактериална защита в съответствие с изискванията по стандарт JIS Z 2801

BLANK 2M

- blank modul to fill up empty spaces
- in accordance with EN 60669-1
- antibacterial protection in accordance with JIS Z 2801

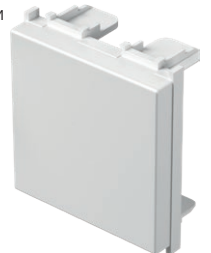



□ VM10AW

КОНТАКТ SCHUKO+KS 2P+E 16A 250V~ 2M

- 2P+E шуко, 16A 250V~, тип VM10
- в съответствие с IEC 60884-1, CEE7
- винтови контакти 1,5 - 2,5 mm²
- Вградена защита от допир на контакти
- антибактериална защита в съответствие с изискванията по стандарт JIS Z 2801

SOCKET SCHUKO+KS 2P+E 16A 250V~ 2M

- 2P+E schuko
- 16A 250V~, type VM10
- in accordance with IEC 60884-1, CEE7
- screw contacts 1.5-2.5 mm²
- shuttered live contacts
- antibacterial protection in accordance with JIS Z 2801



□ VM11AW

КОНТАКТ SCHUKO+KS+COVER 2P+E 16A 250V~ 2M

- 2P+E шуко+капак, 16A 250V~, тип VM11
- в съответствие с IEC 60884-1, CEE7
- винтови контакти 1,5 - 2,5 mm²
- Вградена защита от допир на контакти
- антибактериална защита в съответствие с изискванията по стандарт JIS Z 2801

SOCKET SCHUKO+KS+COVER

- 2P+E schuko+cover
- 16A 250V~, type VM11
- in accordance with IEC 60884-1, CEE7
- screw contacts 1.5-2.5 mm²
- shuttered live contacts
- antibacterial protection in accordance with JIS Z 2801



□ VM20AW

КОНТАКТ EURO+KS 2P 10 A 250 V~ 1M

- 2P Euro, 10 A 250 V~, тип VM20
- в съответствие с IEC 60884-1, CEE7
- винтови контакти 1,5 - 2,5 mm²
- Вградена защита от допир на контакти
- антибактериална защита в съответствие с изискванията по стандарт JIS Z 2801

SOCKET EURO+KS 2P 10A 250V~ 1M

- 2P Euro
- 10A 250V~, type VM20
- in accordance with IEC 60884-1, CEE7
- screw contacts 1.5-2.5 mm²
- shuttered live contacts
- antibacterial protection in accordance with JIS Z 2801



□ KM11AW

КОНЕКТОР ЗА ТВ КРАЕН 1 dB 1M

- контакт за ТВ краен
- честотен обхват 5÷2400 MHz, затихване < 1 dB
- в съответствие с EN 50083-1
- винтови контакти
- антибактериална защита в съответствие с изискванията по стандарт JIS Z 2801

SOCKET TV END-LINE 1dB 1M

- TV end-line
- frequency range 5÷2400 MHz
- reduction < 1 dB
- in accordance with EN 50083-1
- screw contacts
- antibacterial protection in accordance with JIS Z 2801

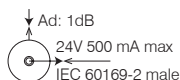

□ KM35AW

АДАПТЕР KS 1M

- KS модул стандарт за закрепване
- AMP, Avaya, Brandrex, FMT, Mfico, Tyco, ...
- комуникационният модул не е включен в доставката
- антибактериална защита в съответствие с изискванията по стандарт JIS Z 2801

ADAPTER KS 1M

- KS keystone fixing standard
- AMP, Avaya, Brandrex, FMT, Mfico, Tyco, ...
- communication module not included
- antibacterial protection in accordance with JIS Z 2801



A N T I B A C T E R I A L P R O G R A M M O D U L



OS20AW

ПАНЕЛ SOFT 2M

- декоративен панел SOFT 2M
- в съответствие с EN 60669-1
- антибактериална защита в съответствие с изискванията по стандарт JIS Z 2801

COVER PLATE SOFT 2M

- decorative cover plate SOFT 2M
- in accordance with EN 60669-1
- antibacterial protection in accordance with JIS Z 2801



OS24AW

ПАНЕЛ SOFT 2x2M

- декоративен панел SOFT 2x2M
- хоризонтален или вертикален монтаж
- в съответствие с EN 60669-1
- антибактериална защита в съответствие с изискванията по стандарт JIS Z 2801

COVER PLATE SOFT 2x2M

- decorative cover plate SOFT 2x2M
- horizontal or vertical mounting
- in accordance with EN 60669-1
- antibacterial protection in accordance with JIS Z 2801



OS26AW

ПАНЕЛ SOFT 3x2M

- декоративен панел SOFT 3x2M
- хоризонтален или вертикален монтаж
- в съответствие с EN 60669-1
- антибактериална защита в съответствие с изискванията по стандарт JIS Z 2801

COVER PLATE SOFT 3x2M

- decorative cover plate SOFT 3x2M
- horizontal or vertical mounting
- in accordance with EN 60669-1
- antibacterial protection in accordance with JIS Z 2801



OS30AW

ПАНЕЛ SOFT 3M

- декоративен панел SOFT 3M
- в съответствие с EN 60669-1
- антибактериална защита в съответствие с изискванията по стандарт JIS Z 2801

COVER PLATE SOFT 3M

- decorative cover plate SOFT 3M
- in accordance with EN 60669-1
- antibacterial protection in accordance with JIS Z 2801



OS40AW

ПАНЕЛ SOFT 4M

- декоративен панел SOFT 4M
- в съответствие с EN 60669-1
- антибактериална защита в съответствие с изискванията по стандарт JIS Z 2801

COVER PLATE SOFT 4M

- decorative cover plate SOFT 4M
- in accordance with EN 60669-1
- antibacterial protection in accordance with JIS Z 2801

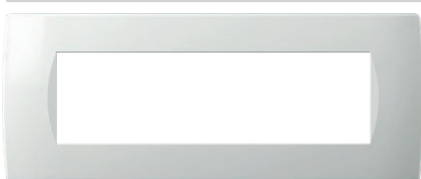

OS70AW

ПАНЕЛ SOFT 7M

- декоративен панел SOFT 7M
- в съответствие с EN 60669-1
- антибактериална защита в съответствие с изискванията по стандарт JIS Z 2801

COVER PLATE SOFT 7M

- decorative cover plate SOFT 7M
- in accordance with EN 60669-1
- antibacterial protection in accordance with JIS Z 2801

ДЪРВО
wood

WB бамбук
bamboo



WW орех
walnut



WM клен
maple



WE венге
wenge



Природата е уникална и прецизна, и сред нашите декоративни панели няма два еднакви.
Рекламации във връзка с разнообразния външен вид на дървени декоративни панели и различия не се приемат.

Nature is unique and precious, as our decorative cover plates where no two are the same.
Complaints about wooden decorative cover plate's diverse appearance and differentiation cannot be considered.

COVER PLATES PURE OP

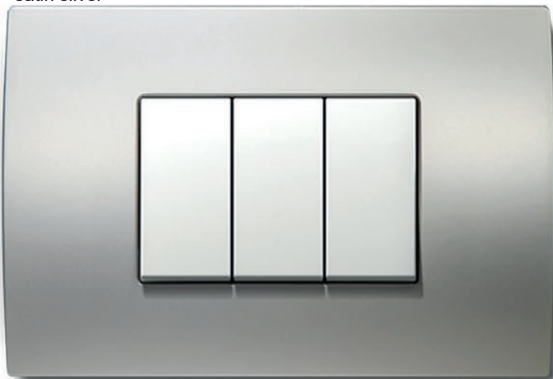
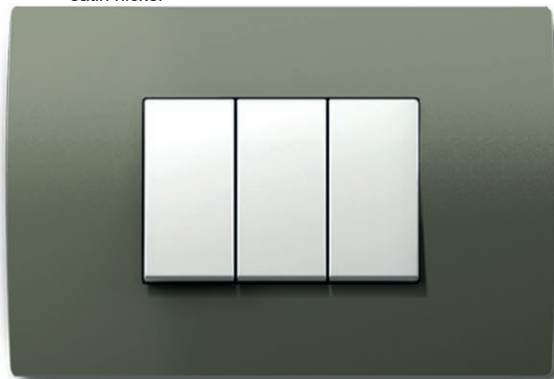
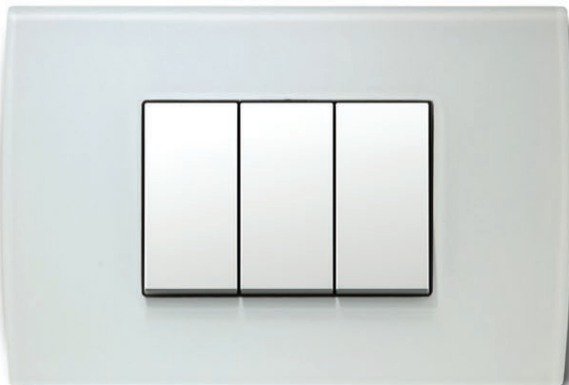
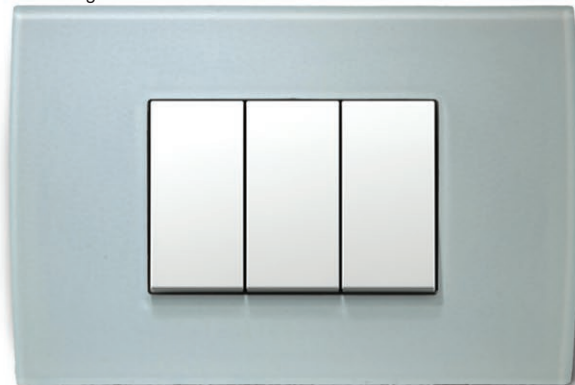
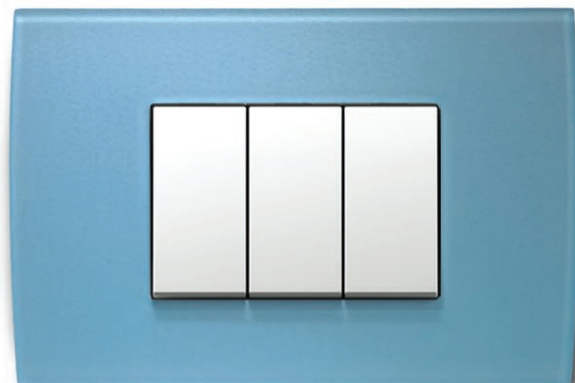
МЕТАЛ
metalMH ковано желязо
hammered steelME ецвано желязо
etched ironMS матов сребрист цвят
satin silverMN матов никел
satin nickelСТЪКЛО
glassGW снежнобял цвят
ice whiteGG снежнозелен
ice greenGY снежносив
ice greyGB снежносин
ice blue



тип type	описание description	размер size	цвет colour					
OP13	ПАНЕЛ PURE COVER PLATE PURE	1/3M	MH	ковано желязо hammered steel	WB	бамбук bamboo	GW	снежнобял цвят ice white
OP20	ПАНЕЛ PURE COVER PLATE PURE	2M	ME	ецовано желязо etched iron	WW	орех walnut	GG	снежнозелен ice green
OP23	ПАНЕЛ PURE COVER PLATE PURE	2/3M	MS	матов сребрист цвет satin silver	WM	клен maple	GY	снежносив ice grey
.	.	.	MN	матов никел satin nickel	WE	венге wenge	GB	снежносив ice blue



OP20MH	OP20WB
OP20ME	OP20WW
OP20MS	OP20WM
OP20MN	OP20WE
	OP20GW
	OP20GG
	OP20GY
	OP20GB

ПАНЕЛ PURE 2M

- декоративен панел PURE 2M
- в съответствие с EN 60669-1
- само в комбинация с монтажна рамка NM24 или NM25

COVER PLATE PURE 2M

- decorative cover plate PURE 2M
- in accordance with EN 60669-1
- only in combination with mounting frame NM24 or NM25

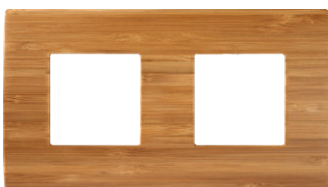

OP24MH	OP24WB
OP24ME	OP24WW
OP24MS	OP24WM
OP24MN	OP24WE
	OP24GW
	OP24GG
	OP24GY
	OP24GB

ПАНЕЛ PURE 2x2M

- декоративен панел PURE 2x2M
- хоризонтален или вертикален монтаж
- в съответствие с EN 60669-1
- само в комбинация с монтажна рамка NM24 или NM25

COVER PLATE PURE 2x2M

- decorative cover plate PURE 2x2M
- horizontal or vertical mounting
- in accordance with EN 60669-1
- only in combination with mounting frames NM24 or NM25



OP26MH	OP26WB
OP26ME	OP26WW
OP26MS	OP26WM
OP26MN	OP26WE
	OP26GW
	OP26GG
	OP26GY
	OP26GB

ПАНЕЛ PURE 3x2M

- декоративен панел PURE 3x2M
- хоризонтален или вертикален монтаж
- в съответствие с EN 60669-1
- само в комбинация с монтажна рамка NM24 или NM25

COVER PLATE PURE 3x2M

- decorative cover plate PURE 3x2M
- horizontal or vertical mounting
- in accordance with EN 60669-1
- only in combination with mounting frames NM24 or NM25



OP28MH	OP28WB
OP28ME	OP28WW
OP28MS	OP28WM
OP28MN	OP28WE
	OP28GW
	OP28GG
	OP28GY
	OP28GB

ПАНЕЛ PURE 4x2M

- декоративен панел PURE 4x2M
- хоризонтален или вертикален монтаж
- в съответствие с EN 60669-1
- само в комбинация с монтажна рамка NM24 или NM25

COVER PLATE PURE 4x2M

- decorative cover plate PURE 4x2M
- horizontal or vertical mounting
- in accordance with EN 60669-1
- only in combination with mounting frames NM24 or NM25

COVER PLATES PURE OP



	OP30MH		OP30WB
	OP30ME		OP30WW
	OP30MS		OP30WM
	OP30MN		OP30WE
			OP30GW
			OP30GG
			OP30GY
			OP30GB

ПАНЕЛ PURE 3M

- декоративен панел PURE 3M
- в съответствие с EN 60669-1

COVER PLATE PURE 3M

- decorative cover plate PURE 3M
- in accordance with EN 60669-1



	OP40MH		OP40WB
	OP40ME		OP40WW
	OP40MS		OP40WM
	OP40MN		OP40WE
			OP40GW
			OP40GG
			OP40GY
			OP40GB

ПАНЕЛ PURE 4M

- декоративен панел PURE 4M
- в съответствие с EN 60669-1

COVER PLATE PURE 4M

- decorative cover plate PURE 4M
- in accordance with EN 60669-1



	OP70MH		OP70WB
	OP70ME		OP70WW
	OP70MS		OP70WM
	OP70MN		OP70WE
			OP70GW
			OP70GG
			OP70GY
			OP70GB

ПАНЕЛ PURE 7M

- декоративен панел PURE 7M
- в съответствие с EN 60669-1

COVER PLATE PURE 7M

- decorative cover plate PURE 7M
- in accordance with EN 60669-1



	OP13MH		OP13WB
	OP13ME		OP13WW
	OP13MS		OP13WM
	OP13MN		OP13WE
			OP13GW
			OP13GG
			OP13GY
			OP13GB

ПАНЕЛ PURE 1/3M

- декоративен панел PURE 1/3M
- в съответствие с EN 60669-1

COVER PLATE PURE 1/3M

- decorative cover plate PURE 1/3M
- in accordance with EN 60669-1



	OP23MH		OP23WB
	OP23ME		OP23WW
	OP23MS		OP23WM
	OP23MN		OP23WE
			OP23GW
			OP23GG
			OP23GY
			OP23GB

ПАНЕЛ PURE 2/3M

- декоративен панел PURE 2/3M
- в съответствие с EN 60669-1

COVER PLATE PURE 2/3M

- decorative cover plate PURE 2/3M
- in accordance with EN 60669-1

базов
basic

PW снежнобял цвят
polar white

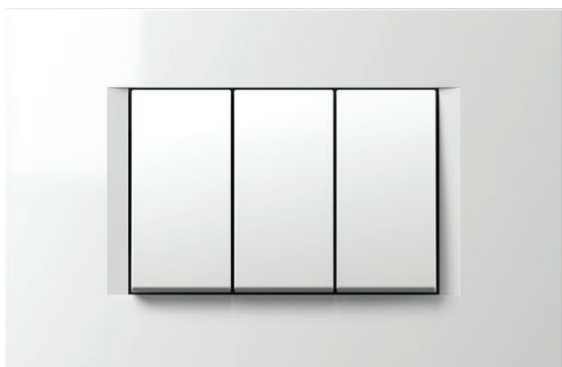

IW слонова кост
ivory white

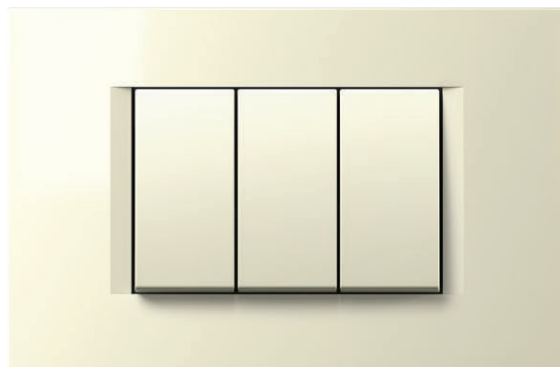

ES сребрист цвят с анодизирано покритие
elox silver



SB сензорен бутон, черен
soft touch black



AT антрацит
anthracite

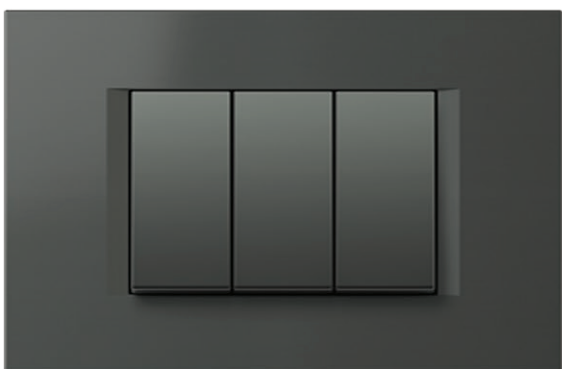

C O V E R P L A T E S L I N E O L

декор
decor

SG пясъчнозлатист
sand gold

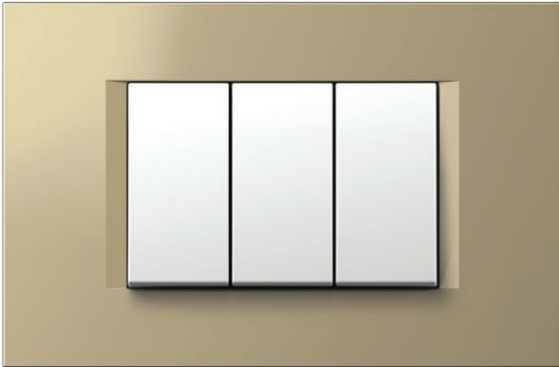

NB тъмночерен
night black

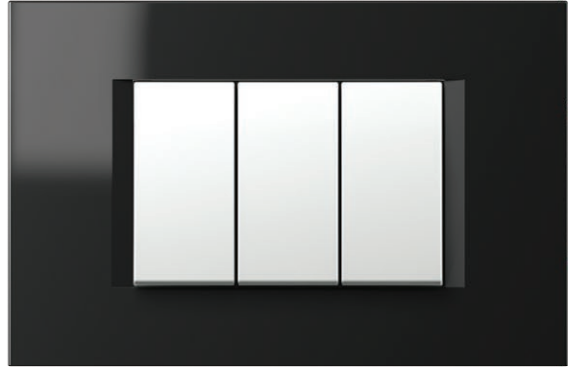

IB Импулно синьо
impulse blue

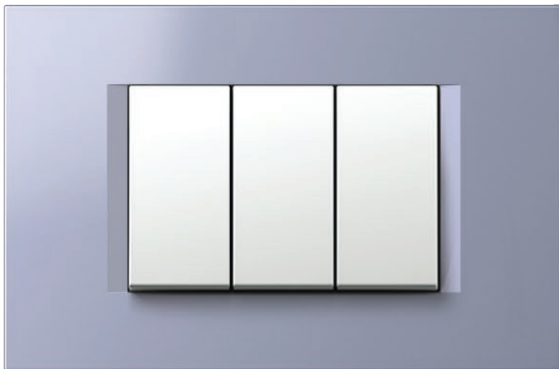

TI титан
titanium



SW бял камък
stone white



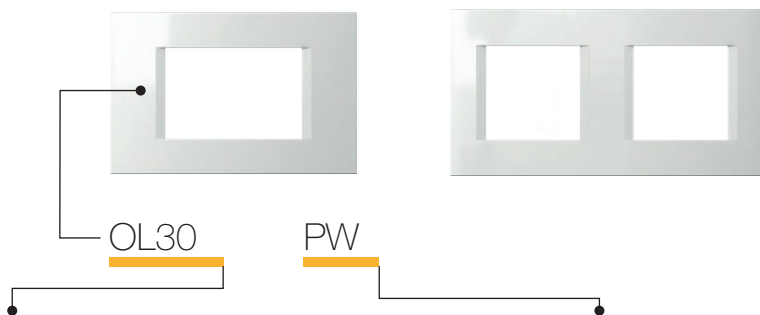

тип type	описание description	размер size	ЦВЯТ colour																		
OL10	ПАНЕЛ LINE COVER PLATE LINE	1/2M	<table border="0"> <tr> <td></td> <td>PW</td> <td>снежнобял цвят polar white</td> <td></td> <td>SG</td> <td>пясъчнозлатист sand gold</td> <td></td> <td>AT</td> <td>антрацит anthracite</td> </tr> </table>		PW	снежнобял цвят polar white		SG	пясъчнозлатист sand gold		AT	антрацит anthracite									
	PW	снежнобял цвят polar white		SG	пясъчнозлатист sand gold		AT	антрацит anthracite													
OL13	ПАНЕЛ LINE COVER PLATE LINE	1/3M	<table border="0"> <tr> <td></td> <td>IW</td> <td>слонова кост ivory white</td> <td></td> <td>NB</td> <td>тъмночерен night black</td> <td></td> <td>TI</td> <td>титан titanium</td> </tr> </table>		IW	слонова кост ivory white		NB	тъмночерен night black		TI	титан titanium									
	IW	слонова кост ivory white		NB	тъмночерен night black		TI	титан titanium													
OL20	ПАНЕЛ LINE COVER PLATE LINE	2M	<table border="0"> <tr> <td></td> <td>ES</td> <td>сребрист цвят с анодизирано покритие elox silver</td> <td></td> <td>IB</td> <td>Импулсно синьо impulse blue</td> <td></td> <td>SW</td> <td>бял камък stone white</td> </tr> <tr> <td></td> <td>SB</td> <td>сензорен бутон, черен soft touch black</td> <td></td> <td></td> <td></td> <td></td> <td></td> <td></td> </tr> </table>		ES	сребрист цвят с анодизирано покритие elox silver		IB	Импулсно синьо impulse blue		SW	бял камък stone white		SB	сензорен бутон, черен soft touch black						
	ES	сребрист цвят с анодизирано покритие elox silver		IB	Импулсно синьо impulse blue		SW	бял камък stone white													
	SB	сензорен бутон, черен soft touch black																			



ПАНЕЛ LINE 2M

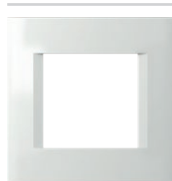

	OL20PW		OL20SG
	OL20IW		OL20NB
	OL20ES		OL20IB
	OL20SB		OL20AT
			OL20TI
			OL20SW

- декоративен панел LINE 2M
- в съответствие с EN 60669-1

COVER PLATE LINE 2M

- decorative cover plate LINE 2M
- in accordance with EN 60669-1

ПАНЕЛ LINE 2x2M

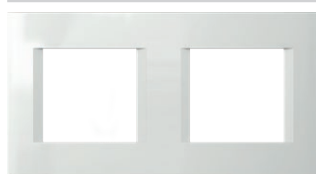

	OL24PW		OL24SG
	OL24IW		OL24NB
	OL24ES		OL24IB
	OL24SB		OL24AT
			OL24TI
			OL24SW

- декоративен панел LINE 2x2M
- хоризонтален или вертикален монтаж
- в съответствие с EN 60669-1

COVER PLATE LINE 2x2M

- decorative cover plate LINE 2x2M
- horizontal or vertical mounting
- in accordance with EN 60669-1

ПАНЕЛ LINE 3x2M

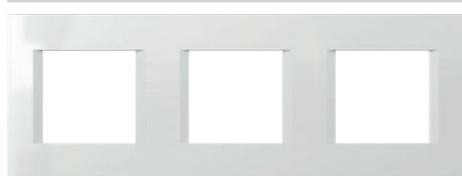

	OL26PW		OL26SG
	OL26IW		OL26NB
	OL26ES		OL26IB
	OL26SB		OL26AT
			OL26TI
			OL26SW

- декоративен панел LINE 3x2M
- хоризонтален или вертикален монтаж
- в съответствие с EN 60669-1

COVER PLATE LINE 3x2M

- decorative cover plate LINE 3x2M
- horizontal or vertical mounting
- in accordance with EN 60669-1

ПАНЕЛ LINE 4x2M



	OL28PW		OL28SG
	OL28IW		OL28NB
	OL28ES		OL28IB
	OL28SB		OL28AT
			OL28TI
			OL28SW

- декоративен панел LINE 4x2M
- хоризонтален или вертикален монтаж
- в съответствие с EN 60669-1

COVER PLATE LINE 4x2M

- decorative cover plate LINE 4x2M
- horizontal or vertical mounting
- in accordance with EN 60669-1

ПАНЕЛ LINE 5x2M

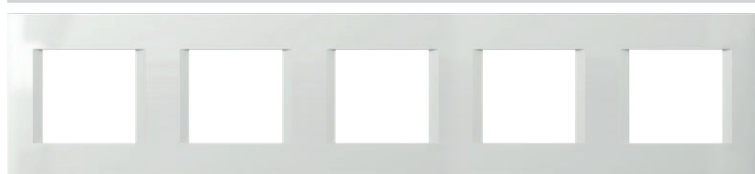

	OL29PW
	OL29IW
	OL29ES
	OL29SB
	OL29AT
	OL29TI



- декоративен панел LINE 5x2M
- хоризонтален или вертикален монтаж
- в съответствие с EN 60669-1

COVER PLATE LINE 5x2M

- decorative cover plate LINE 5x2M
- horizontal or vertical mounting
- in accordance with EN 60669-1

COVER PLATES LINE OL



 OL30PW	 OL30SG
 OL30IW	 OL30NB
 OL30ES	 OL30IB
 OL30SB	 OL30AT
	 OL30TI
	 OL30SW











ПАНЕЛ LINE 3M

- декоративен панел LINE 3M
- в съответствие с EN 60669-1

COVER PLATE LINE 3M

- decorative cover plate LINE 3M
- in accordance with EN 60669-1



 OL40PW	 OL40SG
 OL40IW	 OL40NB
 OL40ES	 OL40IB
 OL40SB	 OL40AT
	 OL40TI
	 OL40SW



ПАНЕЛ LINE 4M

- декоративен панел LINE 4M
- в съответствие с EN 60669-1

COVER PLATE LINE 4M

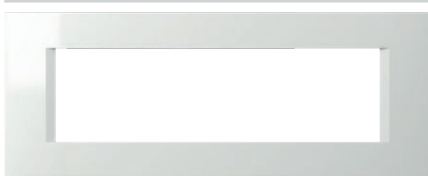
- decorative cover plate LINE 4M
- in accordance with EN 60669-1



 OL70PW	 OL70SG
 OL70IW	 OL70NB
 OL70ES	 OL70IB
 OL70SB	 OL70AT
	 OL70TI
	 OL70SW

ПАНЕЛ LINE 7M

- декоративен панел LINE 7M
- в съответствие с EN 60669-1

COVER PLATE LINE 7M

- decorative cover plate LINE 7M
- in accordance with EN 60669-1



 OL10PW	 OL10SG
 OL10IW	 OL10NB
 OL10ES	 OL10IB
 OL10SB	 OL10AT
	 OL10TI
	 OL10SW

ПАНЕЛ LINE 1/2M

- декоративен панел LINE 1/2M
- в съответствие с EN 60669-1

COVER PLATE LINE 1/2M

- decorative cover plate LINE 1/2M
- in accordance with EN 60669-1

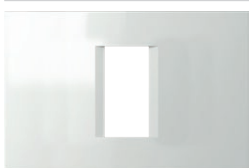

 OL13PW	 OL13SG
 OL13IW	 OL13NB
 OL13ES	 OL13IB
 OL13SB	 OL13AT
	 OL13TI
	 OL13SW











ПАНЕЛ LINE 1/3M

- декоративен панел LINE 1/3M
- в съответствие с EN 60669-1

COVER PLATE LINE 1/3M

- decorative cover plate LINE 1/3M
- in accordance with EN 60669-1



 OL23PW	 OL23SG
 OL23IW	 OL23NB
 OL23ES	 OL23IB
 OL23SB	 OL23AT
	 OL23TI
	 OL23SW

ПАНЕЛ LINE 2/3M

- декоративен панел LINE 2/3M
- в съответствие с EN 60669-1

COVER PLATE LINE 2/3M

- decorative cover plate LINE 2/3M
- in accordance with EN 60669-1

базов
basic

PW снежнобял цвят
polar white

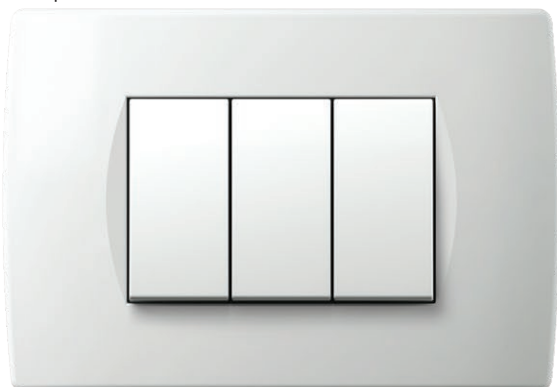

IW слонова кост
ivory white

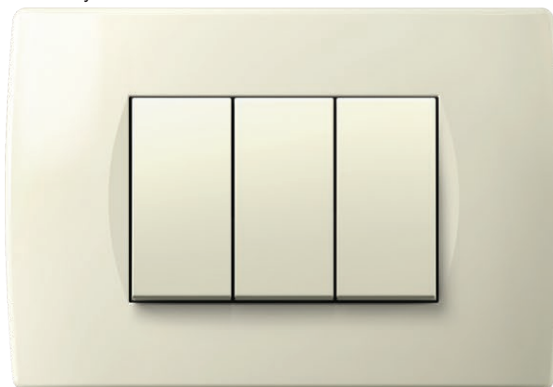

ES сребрист цвят с анодизирано покритие
elox silver

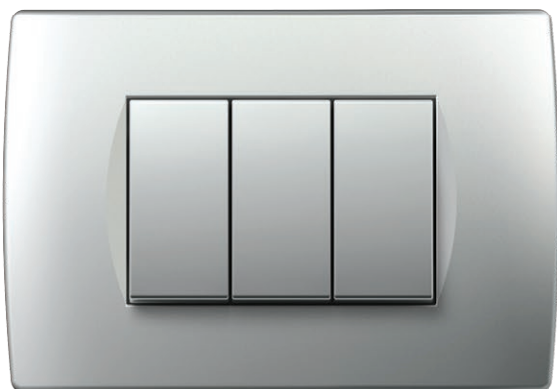

SB сензорен бутон, черен
soft touch black



AT anthracite



C O V E R P L A T E S S O F T O S

декор
decor

SG пясъчнозлатист
sand gold

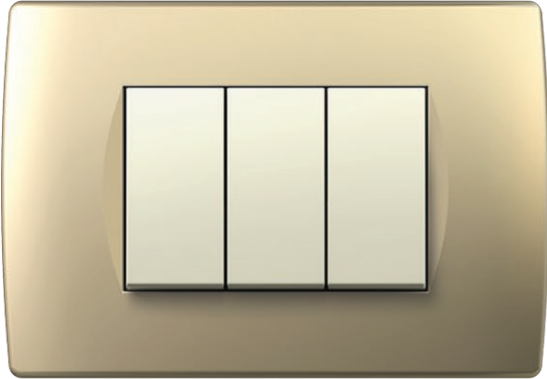

NB тъмночерен
night black



TI антрацит
titanium



WE титан
wenge

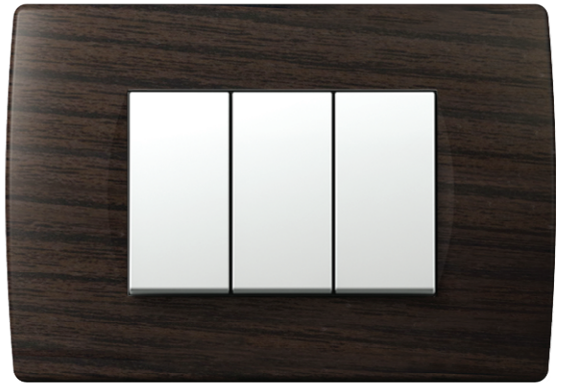

WW венге
walnut



орех

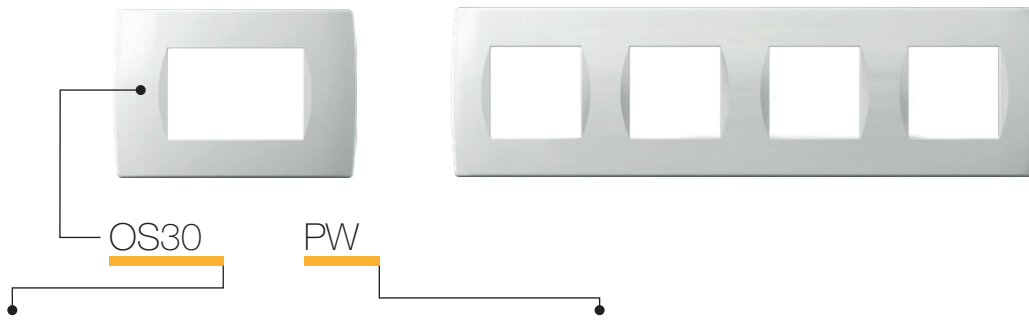

тип type	описание description	размер size	ЦВЯТ colour																		
OS10	ПАНЕЛ SOFT COVER PLATE SOFT	1/2M	<table border="0"> <tr> <td></td> <td>PW</td> <td>снежнобял цвят polar white</td> <td></td> <td>SG</td> <td>пясъчнозлатист sand gold</td> <td></td> <td>WW</td> <td>орех walnut</td> </tr> </table>		PW	снежнобял цвят polar white		SG	пясъчнозлатист sand gold		WW	орех walnut									
	PW	снежнобял цвят polar white		SG	пясъчнозлатист sand gold		WW	орех walnut													
OS13	ПАНЕЛ SOFT COVER PLATE SOFT	1/3M	<table border="0"> <tr> <td></td> <td>IW</td> <td>слонова кост ivory white</td> <td></td> <td>NB</td> <td>тъмночерен night black</td> <td></td> <td>WE</td> <td>венге wenge</td> </tr> </table>		IW	слонова кост ivory white		NB	тъмночерен night black		WE	венге wenge									
	IW	слонова кост ivory white		NB	тъмночерен night black		WE	венге wenge													
OS20	ПАНЕЛ SOFT COVER PLATE SOFT	2M	<table border="0"> <tr> <td></td> <td>ES</td> <td>сребрист цвят с анодизирано покритие elox silver</td> <td></td> <td>AT</td> <td>антрацит anthracite</td> <td></td> <td>TI</td> <td>титан titanium</td> </tr> <tr> <td></td> <td>SB</td> <td>сензорен бутон, черен soft touch black</td> <td></td> <td></td> <td></td> <td></td> <td></td> <td></td> </tr> </table>		ES	сребрист цвят с анодизирано покритие elox silver		AT	антрацит anthracite		TI	титан titanium		SB	сензорен бутон, черен soft touch black						
	ES	сребрист цвят с анодизирано покритие elox silver		AT	антрацит anthracite		TI	титан titanium													
	SB	сензорен бутон, черен soft touch black																			
...																		



	OS20PW		OS20SG
	OS20IW		OS20NB
	OS20ES		OS20AT
	OS20SB		OS20TI
			OS20WW
			OS20WE

ПАНЕЛ SOFT 2M

- декоративен панел SOFT 2M
- в съответствие с EN 60669-1

COVER PLATE SOFT 2M

- decorative cover plate SOFT 2M
- in accordance with EN 60669-1



	OS24PW		OS24SG
	OS24IW		OS24NB
	OS24ES		OS24AT
	OS24SB		OS24TI
			OS24WW
			OS24WE

ПАНЕЛ SOFT 2x2M

- декоративен панел SOFT 2x2M
- хоризонтален или вертикален монтаж
- в съответствие с EN 60669-1

COVER PLATE SOFT 2x2M

- decorative cover plate SOFT 2x2M
- horizontal or vertical mounting
- in accordance with EN 60669-1



	OS26PW		OS26SG
	OS26IW		OS26NB
	OS26ES		OS26AT
	OS26SB		OS26TI
			OS26WW
			OS26WE

ПАНЕЛ SOFT 3x2M

- декоративен панел SOFT 3x2M
- хоризонтален или вертикален монтаж
- в съответствие с EN 60669-1

COVER PLATE SOFT 3x2M

- decorative cover plate SOFT 3x2M
- horizontal or vertical mounting
- in accordance with EN 60669-1



	OS28PW		OS28SG
	OS28IW		OS28NB
	OS28ES		OS28AT
	OS28SB		OS28TI
			OS28WW
			OS28WE

ПАНЕЛ SOFT 4x2M

- декоративен панел SOFT 4x2M
- хоризонтален или вертикален монтаж
- в съответствие с EN 60669-1

COVER PLATE SOFT 4x2M

- decorative cover plate SOFT 4x2M
- horizontal or vertical mounting
- in accordance with EN 60669-1

COVER PLATES SOFT OS



 OS30PW	 OS30SG
 OS30IW	 OS30NB
 OS30ES	 OS30AT
 OS30SB	 OS30TI
	 OS30WW
	 OS30WE





ПАНЕЛ SOFT 3M

- декоративен панел SOFT 3M
- в съответствие с EN 60669-1

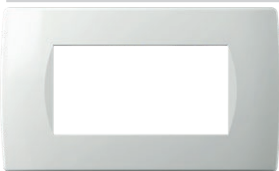
COVER PLATE SOFT 3M

- decorative cover plate SOFT 3M
- in accordance with EN 60669-1



 OS40PW	 OS40SG
 OS40IW	 OS40NB
 OS40ES	 OS40AT
 OS40SB	 OS40TI
	 OS40WW
	 OS40WE





ПАНЕЛ SOFT 4M

- декоративен панел SOFT 4M
- в съответствие с EN 60669-1

COVER PLATE SOFT 4M

- decorative cover plate SOFT 4M
- in accordance with EN 60669-1



 OS70PW	 OS70SG
 OS70IW	 OS70NB
 OS70ES	 OS70AT
 OS70SB	 OS70TI
	 OS70WW
	 OS70WE





ПАНЕЛ SOFT 7M

- декоративен панел SOFT 7M
- в съответствие с EN 60669-1

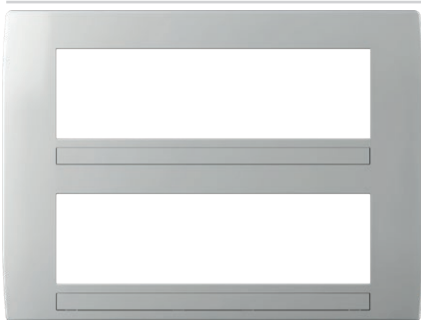
COVER PLATE SOFT 7M

- decorative cover plate SOFT 7M
- in accordance with EN 60669-1



 OS72PW	 OS72AT
 OS72IW	 OS72TI
 OS72ES	
 OS72SB	

ПАНЕЛ SOFT 2x7M

- декоративен панел SOFT 2x7M
панел с надпис
- в съответствие с EN 60669-1

COVER PLATE SOFT 2x7M

- decorative cover plate SOFT 2x7M
with inscription plate
- in accordance with EN 60669-1



 OS10PW	 OS10SG
 OS10IW	 OS10NB
 OS10ES	 OS10AT
 OS10SB	 OS10TI
	 OS10WW
	 OS10WE







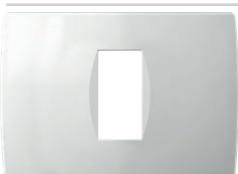

ПАНЕЛ SOFT 1/2M

- декоративен панел SOFT 1/2M
- в съответствие с EN 60669-1

COVER PLATE SOFT 1/2M

- decorative cover plate SOFT 1/2M
- in accordance with EN 60669-1



 OS13PW	 OS13SG
 OS13IW	 OS13NB
 OS13ES	 OS13AT
 OS13SB	 OS13TI
	 OS13WW
	 OS13WE









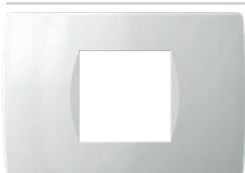

ПАНЕЛ SOFT 1/3M

- декоративен панел SOFT 1/3M
- в съответствие с EN 60669-1

COVER PLATE SOFT 1/3M

- decorative cover plate SOFT 1/3M
- in accordance with EN 60669-1



 OS23PW	 OS23SG
 OS23IW	 OS23NB
 OS23ES	 OS23AT
 OS23SB	 OS23TI
	 OS23WW
	 OS23WE

ПАНЕЛ SOFT 2/3M

- декоративен панел SOFT 2/3M
- в съответствие с EN 60669-1

COVER PLATE SOFT 2/3M

- decorative cover plate SOFT 2/3M
- in accordance with EN 60669-1



ПО ЖЕЛЕНИЕ НА КЛИЕНТА

- лазерно отпечатване на всякакви графични изображения
- по поръчка
- подходящо за панели OL, OS

LASER PRINT ON COVER PLATES

- laser print of any graphics
- made on request
- suitable for cover plates OL, OS



ДЕКОРИРАНЕ НА ПАНЕЛИ







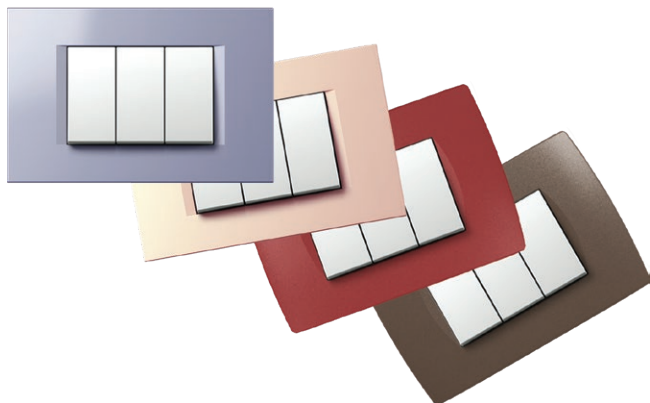

- текстура и цвят по желание на клиента
- по поръчка
- подходящо за панели OL, OS

COVER PLATES DECORATIONS

- customised textures and colours
- made on request
- suitable for cover plates OL, OS

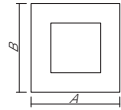
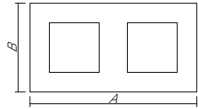
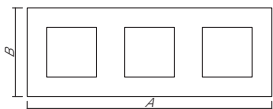
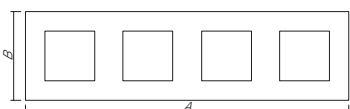
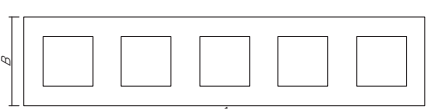

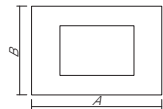
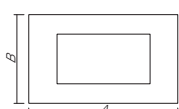
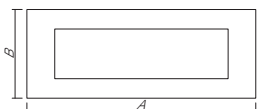
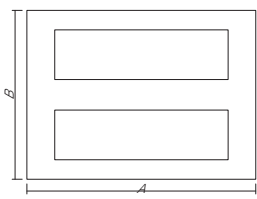
F R A M E S

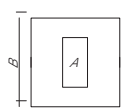
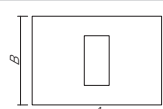
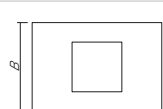
		 line A x B	 soft A x B	 PURE A x B
				
2M		80 x 80 mm	84 x 84 mm	93 x 90 mm
2x2M		151 x 80 mm	155 x 84 mm	164 x 90 mm
3x2M		222 x 80 mm	226 x 84 mm	235 x 90 mm
4x2M		293 x 80 mm	297 x 84 mm	304 x 90 mm
5x2M		364,1 x 80 mm		
				
3M		122 x 80 mm	122 x 84 mm	134 x 90 mm
4M		149 x 80 mm	144 x 84 mm	157 x 90 mm
7M		207 x 80 mm	212 x 84 mm	224 x 90 mm
2x7M			212 x 158 mm	
				
1/2M		80 x 80 mm	84 x 84 mm	
1/3M		122 x 80 mm	122 x 84 mm	134 x 90 mm
2/3M		122 x 80 mm	122 x 84 mm	134 x 90 mm

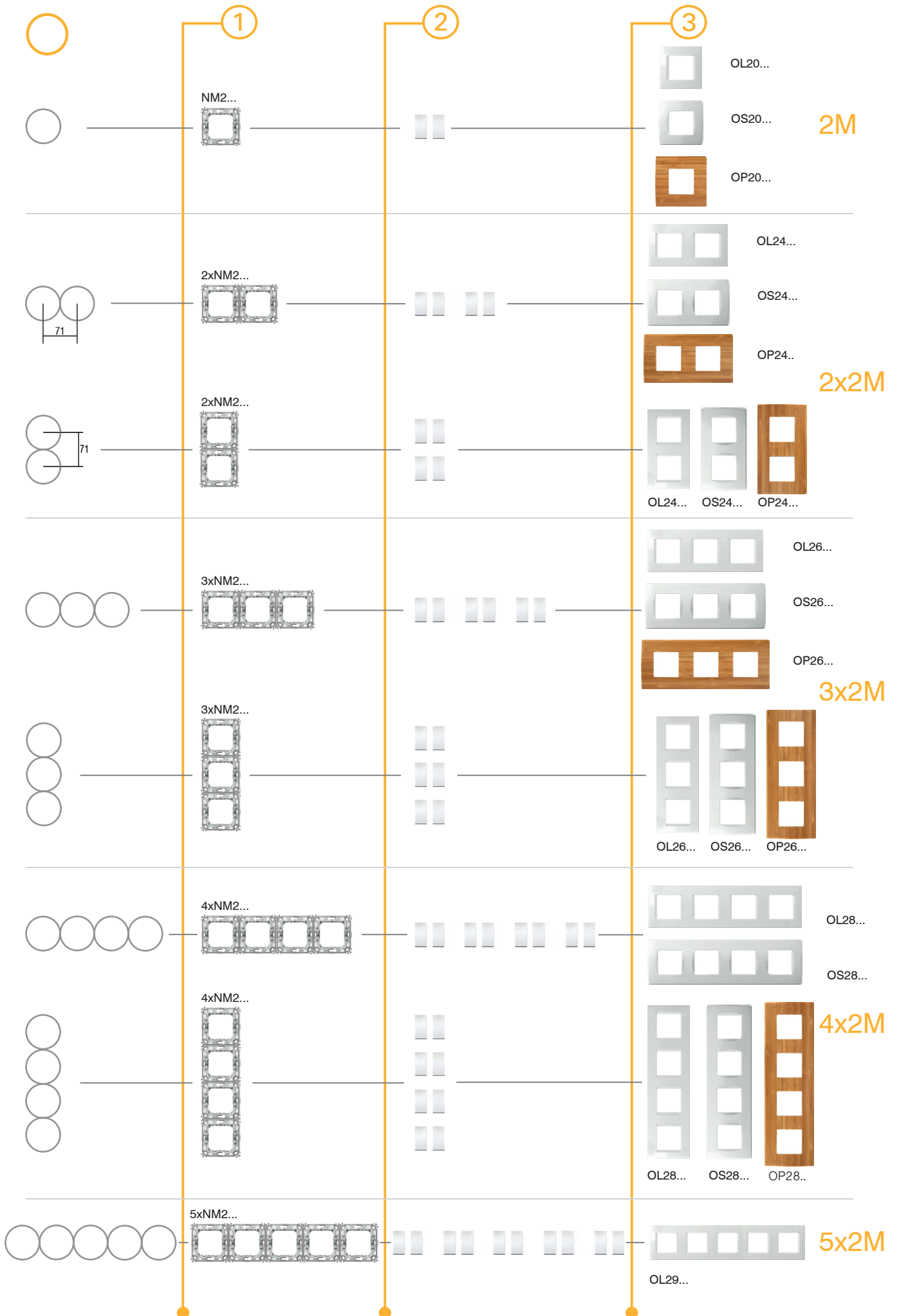

C O M B I N A T I O N S

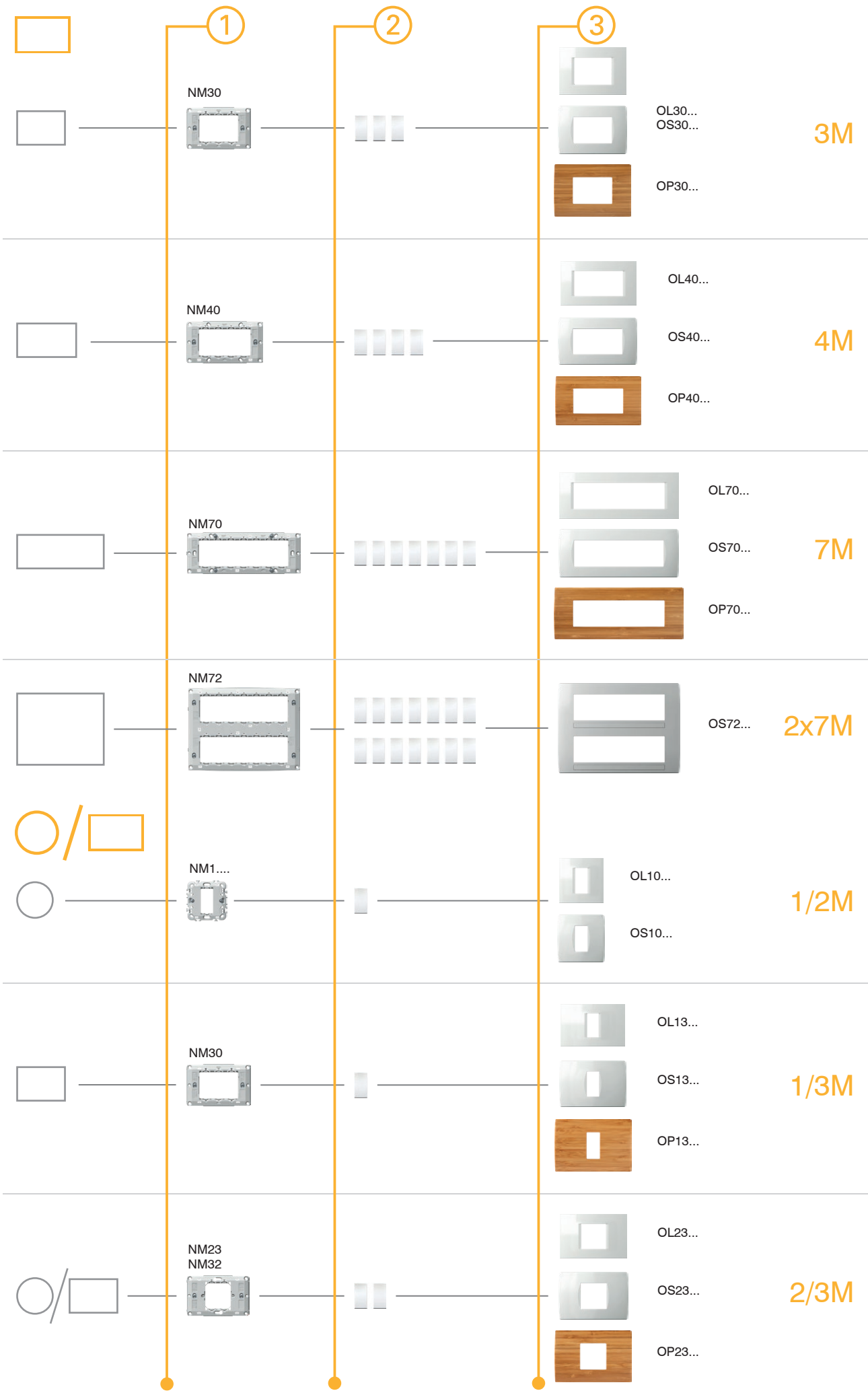

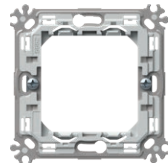
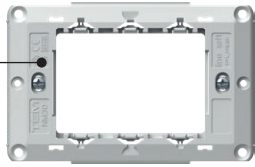

NM30

тип type	описание description	размер size
NM10	МОНТАЖНА РАМКА С ЩИПКИ MOUNTING FRAME WITH CLAWS	1/2M
NM11	МОНТАЖНА РАМКА БЕЗ ВИНТОВЕ MOUNTING FRAME WITHOUT SCREWS	1/2M
NM20	МОНТАЖНА РАМКА С ЩИПКИ MOUNTING FRAME WITH CLAWS	2M
⋮	⋮	⋮



МОНТАЖНА РАМКА С ЩИПКИ 2M

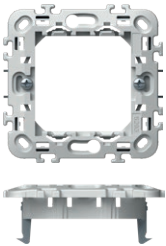

NM20

- монтажна рамка 2M с крачета
- за монтаж на конзоли Ø60 (DE.) с крачета
- възможни са хоризонтални или вертикални комбинации 2x2M, 3x2M и 4x2M
- подходяща за сглобяване с панели LINE и SOFT
- в съответствие с EN 60669-1

MOUNTING FRAME WITH CLAWS 2M

- mounting frame 2M with claws
- for mounting on boxes Ø60 (DE..) with claws
- possible horizontal or vertical combinations 2x2M, 3x2M and 4x2M
- suitable for assembling with cover plates LINE and SOFT
- in accordance with EN 60669-1

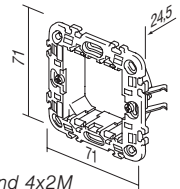

МОНТАЖНА РАМКА БЕЗ ВИНТОВЕ 2M

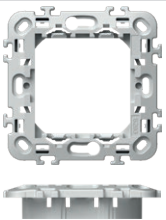

NM21

- монтажна рамка 2M без винтове и без крачета
- за монтаж на конзоли Ø60 (HE., BE.) с винтове
- възможни са хоризонтални или вертикални комбинации 2x2M, 3x2M и 4x2M
- подходяща за сглобяване с панели LINE и SOFT
- в съответствие с EN 60669-1

MOUNTING FRAME WITHOUT SCREWS 2M

- mounting frame 2M without screws and without claws
- for mounting in boxes Ø60 (HE..., BE...) with screws
- possible horizontal or vertical combinations 2x2M, 3x2M and 4x2M
- suitable for assembling with cover plates LINE and SOFT
- in accordance with EN 60669-1

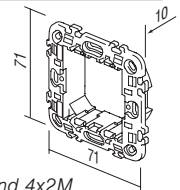

МЕТАЛНА МОНТАЖНА РАМКА С ЩИПКИ 2M

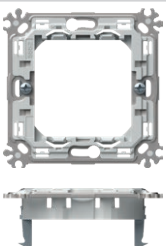

NM24

- метална монтажна рамка 2M с крачета – твърда версия
- за монтаж на конзоли Ø60 (DE.) с крачета
- възможни са хоризонтални или вертикални комбинации 2x2M, 3x2M и 4x2M
- подходяща за сглобяване с панели PURE, LINE и SOFT
- в съответствие с EN 60669-1

MOUNTING FRAME METAL WITH CLAWS 2M

- metal mounting frame 2M with claws - stiff version
- for mounting on boxes Ø60 (DE..) with claws
- possible horizontal or vertical combinations 2x2M, 3x2M and 4x2M
- suitable for assembling with cover plates PURE, LINE and SOFT
- in accordance with EN 60669-1

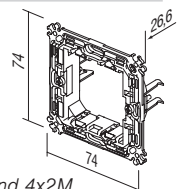

МЕТАЛНА МОНТАЖНА РАМКА БЕЗ ВИНТОВЕ 2M

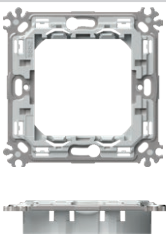

NM25

- метална монтажна рамка без винтове и без крачета – твърда версия
- за монтаж в конзоли Ø60 (HE..., BE...) с винтове
- възможни са хоризонтални или вертикални комбинации 2x2M, 3x2M и 4x2M
- подходяща за сглобяване с панели PURE, LINE и SOFT
- в съответствие с EN 60669-1

MOUNTING FRAME METAL WITHOUT SCREWS 2M

- metal mounting frame 2M without screws and without claws - stiff version
- for mounting in boxes Ø60 (HE..., BE...) with screws
- possible horizontal or vertical combinations 2x2M, 3x2M and 4x2M
- suitable for assembling with cover plates PURE, LINE and SOFT
- in accordance with EN 60669-1

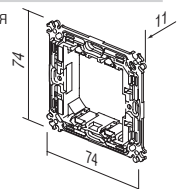

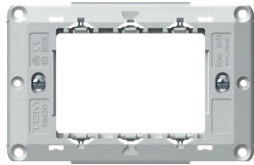

NM30

МОНТАЖНА РАМКА С ВИНТОВЕ 3М

- монтажна рамка 3М с винтове
- за монтаж в правоъгълни конзоли 3М
- подходяща за сглобяване с панели PURE, LINE и SOFT
- в съответствие с EN 60669-1

MOUNTING FRAME WITH SCREWS 3M

- mounting frame 3M with screws
- for mounting on rectangular boxes 3M
- suitable for assembling with cover plates PURE, LINE and SOFT
- in accordance with EN 60669-1

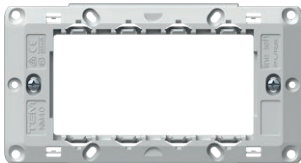
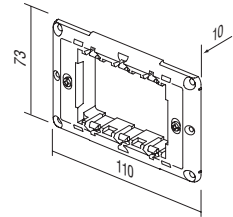

NM40

МОНТАЖНА РАМКА С ВИНТОВЕ 4М

- монтажна рамка 4М с винтове
- за монтаж в правоъгълни конзоли 4М
- подходяща за сглобяване с панели PURE, LINE и SOFT
- в съответствие с EN 60669-1

MOUNTING FRAME WITH SCREWS 4M

- mounting frame 4M with screws
- for mounting on rectangular boxes 4M
- suitable for assembling with cover plates PURE, LINE and SOFT
- in accordance with EN 60669-1

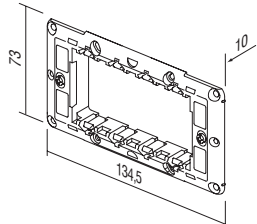

NM70

МОНТАЖНА РАМКА С ВИНТОВЕ 7М

- монтажна рамка 7М с винтове
- за монтаж в правоъгълни конзоли 7М
- подходяща за сглобяване с панели PURE, LINE и SOFT
- в съответствие с EN 60669-1

MOUNTING FRAME WITH SCREWS 7M

- mounting frame 7M with screws
- for mounting on rectangular boxes 7M
- suitable for assembling with cover plates PURE, LINE and SOFT
- in accordance with EN 60669-1

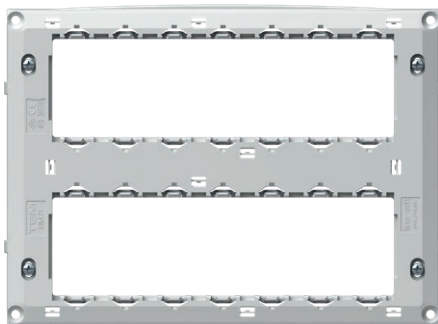
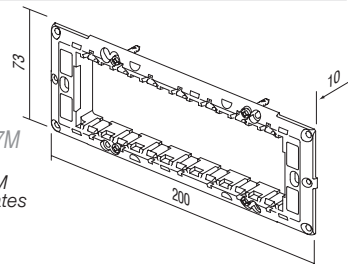

NM72

МОНТАЖНА РАМКА С ВИНТОВЕ 2x7М

- монтажна рамка с винтове 2x7М
- за монтаж в правоъгълни конзоли 2x7М
- подходяща за сглобяване с панел SOFT OS72
- в съответствие с EN 60669-1

MOUNTING FRAME WITH SCREWS 2x7M

- mounting frame 2x7M with screws
- for mounting on rectangular boxes 2x7M
- suitable for assembling with cover plate SOFT OS72
- in accordance with EN 60669-1

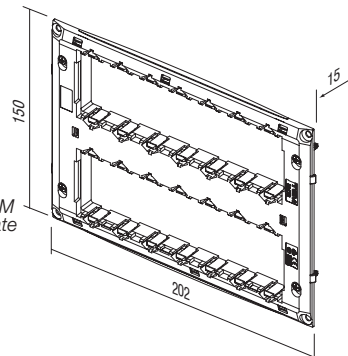

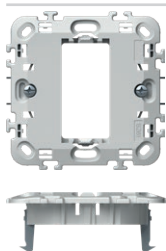

МОНТАЖНА РАМКА С ЩИПКИ 1/2М

NM10

- монтажна рамка 1/2М с крачета
- за монтаж на конзоли Ø60 (DE.) с крачета
- подходяща за сглобяване с панели LINE и SOFT
- в съответствие с EN 60669-1

MOUNTING FRAME WITH CLAWS 1/2M

- mounting frame 1/2M with claws
- for mounting on boxes Ø60 (DE..) with claws
- suitable for assembling with cover plates LINE and SOFT
- in accordance with EN 60669-1

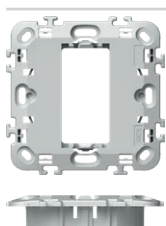
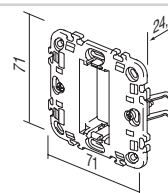

МОНТАЖНА РАМКА БЕЗ ВИНТОВЕ 1/2М

NM11

- монтажна рамка 1/2М без винтове и без крачета
- за монтаж на конзоли Ø60 (HE., BE.) с винтове
- подходяща за сглобяване с панели LINE и SOFT
- в съответствие с EN 60669-1

MOUNTING FRAME WITHOUT SCREWS 1/2M

- mounting frame 1/2M without screws and without claws
- for mounting on boxes Ø60 (HE., BE..) with screws
- suitable for assembling with cover plates LINE and SOFT
- in accordance with EN 60669-1

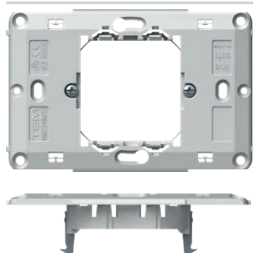
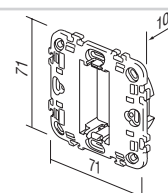

МОНТАЖНА РАМКА С ЩИПКИ 2/3М

NM23

- монтажна рамка 2/3М с крачета
- за монтаж на конзоли Ø60 (DE.) с крачета
- подходяща за сглобяване с панели PURE, LINE и SOFT
- в съответствие с EN 60669-1

MOUNTING FRAME WITH CLAWS 2/3M

- mounting frame 2/3M with claws
- for mounting on boxes Ø60 (DE..) with claws
- suitable for assembling with cover plates PURE, LINE and SOFT
- in accordance with EN 60669-1

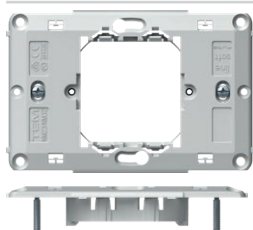
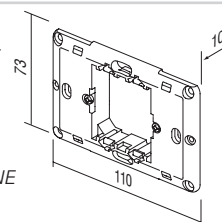

МОНТАЖНА РАМКА С ВИНТОВЕ 2/3М

NM32

- монтажна рамка 2/3М с винтове
- за монтаж в правоъгълни конзоли 3М
- подходяща за сглобяване с панели PURE, LINE и SOFT
- в съответствие с EN 60669-1

MOUNTING FRAME WITH SCREWS 2/3M

- mounting frame 2/3M with screws
- for mounting on rectangular boxes 3M
- suitable for assembling with cover plates PURE, LINE and SOFT
- in accordance with EN 60669-1

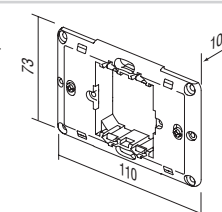

TEM

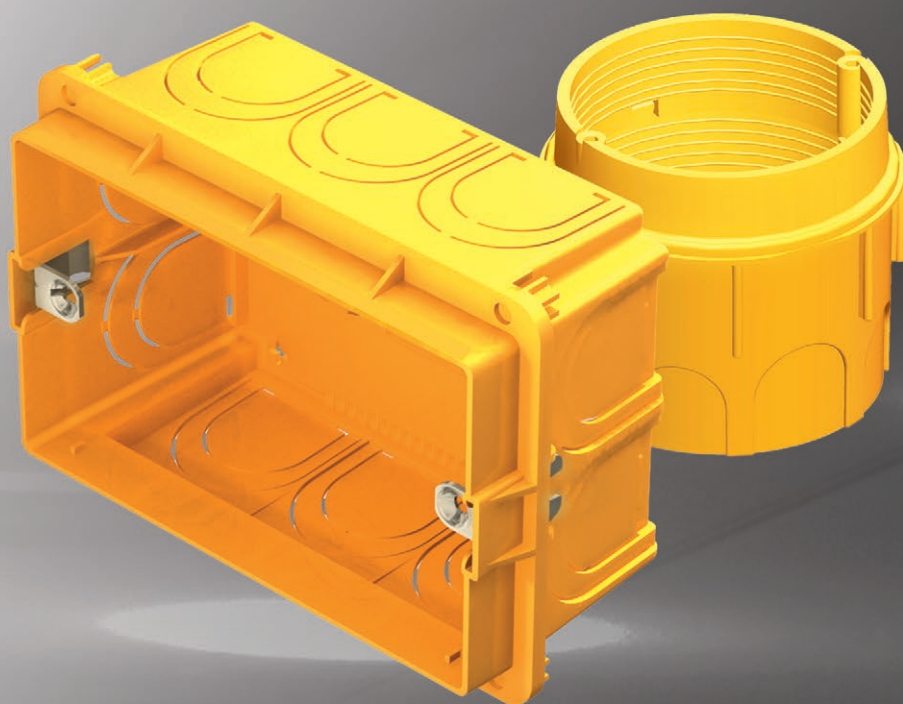

КУТИИ



КРЪГЛИ КОНЗОЛИ
ROUND BOXES



140

ПРАВОЪГЪЛНИ КОНЗОЛИ
RECTANGULAR BOXES



148

СЪЕДИНИТЕЛНИ КУТИИ
JUNCTION BOXES



156

ПРИНАДЛЕЖНОСТИ ЗА СВЪРЗВАНЕ
WIRING ACCESSORIES



158

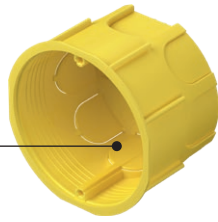

DE12



HE11



BE10

тип type	описание description	размер size
DE10	КРЪГЛИ КОНЗОЛИ ЗА ТУХЛЕНИ СТЕНИ <i>ROUND BOX BRICK</i>	SM60-01
HE10	КРЪГЛИ КОНЗОЛИ ЗА КУХИ СТЕНИ <i>ROUND BOX HOLLOW WALL</i>	SM68X40
BE10	КРЪГЛИ КОНЗОЛИ ЗА СТЕНИ ОТ БЕТОН <i>ROUND BOX CONCRETE</i>	
:	:	:
:	:	:

КРЪГЛИ КОНЗОЛИ ЗА ТУХЛЕНИ СТЕНИ SM60-01



DE10

- Ø60, дълбочина 40 mm
- 650° C, 500 V[~]
- в съответствие с IEC 60670-1
- без съдържание на халоген

ROUND BOX BRICK SM60-01

- Ø60, depth 40mm
- 650° C, 500V[~]
- in accordance with IEC 60670-1
- halogen free

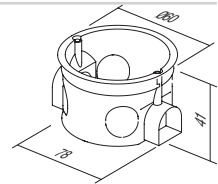

КРЪГЛИ ДЪЛБОКИ КОНЗОЛИ ЗА ТУХЛЕНИ СТЕНИ SM60-06



DE11

- Ø60, дълбочина 60 mm
- 650° C, 500 V[~]
- в съответствие с IEC 60670-1
- без съдържание на халоген

ROUND BOX BRICK DEEP SM60-06

- Ø60, depth 60mm
- 650° C, 500V[~]
- in accordance with IEC 60670-1
- halogen free

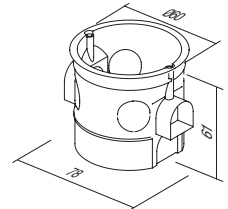

COMBI-CLIP SM60-03



DE30

- за вертикално закрепване на SM60-06 или SM60-01 на разстояние 91 mm
- в съответствие с IEC 60670-1
- без съдържание на халоген

COMBI-CLIP SM60-03

- for vertical fitting of boxes SM60-06 or SM60-01 on distance 91 mm
- in accordance with IEC 60670-1
- halogen free

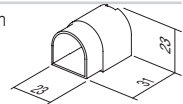

COMBI-CLIP SM60-04

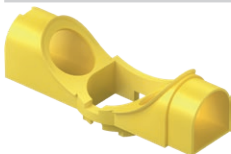

DE31

- за хоризонтално закрепване на SM60-06 или SM60-01 на разстояние 71 mm
- в съответствие с IEC 60670-1
- без съдържание на халоген

COMBI-CLIP SM60-04

- for horizontal fitting of boxes SM60-06 or SM60-01 on distance 71mm
- in accordance with IEC 60670-1
- halogen free

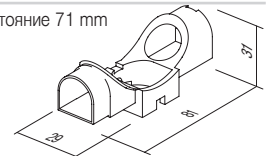

R O U N D B O X E S

	DE12	КРЪГЛИ КОНЗОЛИ ЗА ТУХЛЕНИ СТЕНИ MD65-46 - Ø65, дълбочина 46 mm - 650° C, 500 V~ - в съответствие с IEC 60670-1 - без съдържание на халоген <i>ROUND BOX BRICK MD65-46</i> - Ø65, depth 46mm - 650° C, 500V~ - in accordance with IEC 60670-1 - halogen free	
	DE13	КРЪГЛИ ДЪЛБОКИ КОНЗОЛИ ЗА ТУХЛЕНИ СТЕНИ MD65-60 - Ø65/60, дълбочина 62 mm - 650° C, 500 V~ - в съответствие с IEC 60670-1 - без съдържание на халоген <i>ROUND BOX BRICK DEEP MD65-60</i> - Ø65/60, depth 62mm - 650° C, 500V~ - in accordance with IEC 60670-1 - halogen free	
	DE14	ДОПЪЛНИТЕЛЕН ДЕТАЙЛ ЗА MD65-46 - Ø65/60, дълбочина 17mm - 650° C, 500 V~ - в съответствие с IEC 60670-1 - без съдържание на халоген <i>ADDITIONAL PIECE FOR MD65-46</i> - Ø65/60, depth 17mm - 650° C, 500V~ - in accordance with IEC 60670-1 - halogen free	
	DE32	COMBI-CLIP MD65-71 - за закрепване на конзоли MD65 на разстояние 71 mm - в съответствие с IEC 60670-1 - без съдържание на халоген <i>COMBI-CLIP MD65-71</i> - for fitting of boxes MD65 on distance 71mm - in accordance with IEC 60670-1 - halogen free	
	DE33	COMBI-CLIP MD65-91 - за закрепване на конзоли MD65 на разстояние 91 mm - в съответствие с IEC 60670-1 - без съдържание на халоген <i>COMBI-CLIP MD65-91</i> - for fitting of boxes MD65 on distance 91mm - in accordance with IEC 60670-1 - halogen free	
	DE20	BOX COVER PROTECTIVE 60 - защитно капаче за конзола за конзола Ø60 DE10, DE11, DE13, DE14 - в съответствие с IEC 60670-1 - за защита на конзолата по време на измазване <i>BOX COVER PROTECTIVE 60</i> - protective cover for box Ø60 for DE10, DE11, DE13, DE14 - in accordance with IEC 60670-1 - box protection during plastering	
	DE21	BOX COVER PROTECTIVE 65 - защитно капаче за конзола за конзола Ø65 DE12 - в съответствие с IEC 60670-1 - за защита на конзолата по време на измазване <i>BOX COVER PROTECTIVE 65</i> - protective cover for box Ø65 for DE12 - in accordance with IEC 60670-1 - box protection during plastering	
	DE22	BOX COVER SM60 - декоративно капаче за конзоли Ø60 - в съответствие с IEC 60670-1 - без съдържание на халоген <i>BOX COVER DECORATIVE SM60</i> - decorative cover for boxes Ø60 - in accordance with IEC 60670-1 - halogen free	



К
У
Т
И
И

указания за сглобяване /
assembly instructions

разстояние между конзолите /
distance between boxes: 71 mm

разстояние между конзолите /
distance between boxes: 91 mm

DE10,11

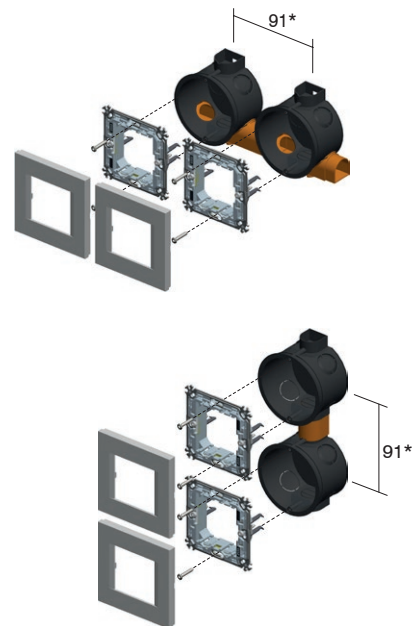
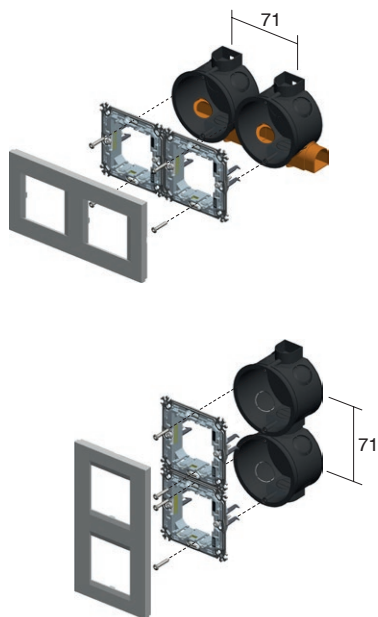
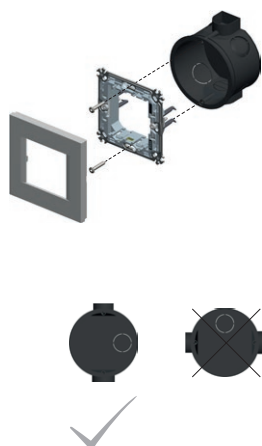

DE12,13

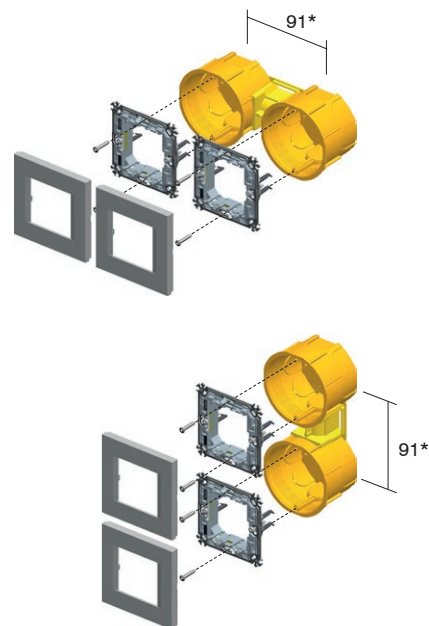
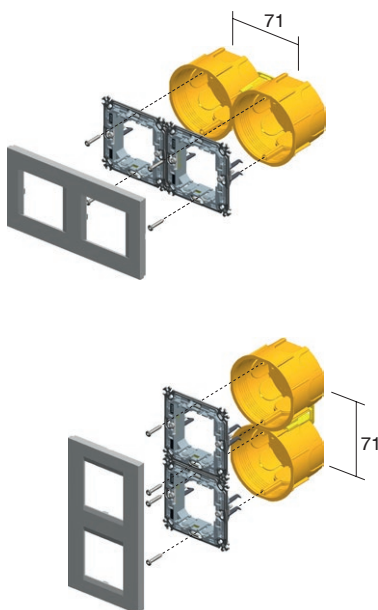
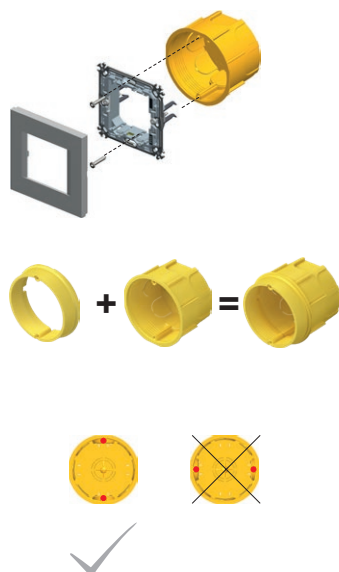

* за панели PURE минималното разстояние между конзолите е 100 mm
* for PURE cover plates the minimum distance between boxes is 100mm

R O U N D B O X E S



DE10,11



DE12,13



NM20



NM24



DE10,11



DE12,13



NM10



71

2xDE10,11 + 2xDE31



2xDE12,13 + 1xDE32



2xNM20



2xNM24



DE10,11



DE12,13



NM23



2xDE10,11



2xDE12,13 + 1xDE32



2xNM20



2xNM24



5xDE10,11

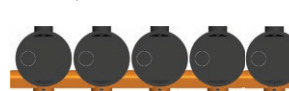

5xNM20



5xDE12,13 + 4xDE32



5xNM24



3xDE10,11 + 3xDE31



3xDE12,13 + 2xDE32



3xNM20



3xNM24

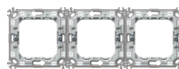

3xDE10,11



3xDE12,13 + 2xDE32



3xNM20

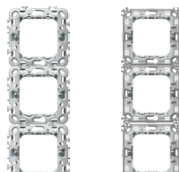

3xNM24



4xDE10,11 + 4xDE31



4xDE12,13 + 3xDE32



4xNM20



4xNM24

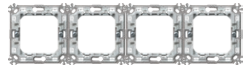

4xDE10,11



4xDE12,13 + 3xDE32



4xNM20

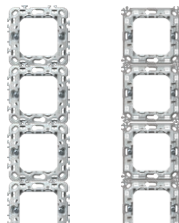

4xNM24



M
M
T
Y
K

КРЪГЛА КОНЗОЛА ЗА КУХИ СТЕНИ SM68x40



HE10

- Ø60, дълбочина 40 mm
- прорязване на отвор Ø68
- 850° C, 400 V~
- в съответствие с IEC 60670-1
- монтаж с крачета
- без съдържание на халоген

ROUND BOX HOLLOW WALL SM68x40

- Ø60, depth 40mm
- cutting hole Ø68
- 850° C, 400V~
- in accordance with IEC 60670-1
- mounting with claws
- halogen free

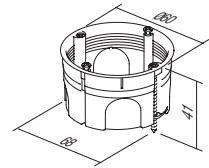

КРЪГЛА КОНЗОЛА ЗА КУХИ СТЕНИ SM68x55



HE11

- Ø60, дълбочина 55 mm
- прорязване на отвор Ø68
- 850° C, 400 V~
- в съответствие с IEC 60670-1
- монтаж с крачета
- без съдържание на халоген

ROUND BOX HOLLOW WALL SM68x55

- Ø60, depth 55mm
- cutting hole Ø68
- 850° C, 400V~
- in accordance with IEC 60670-1
- mounting with claws
- halogen free

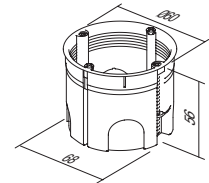

КРЪГЛИ КОНЗОЛИ ЗА СТЕНИ ОТ БЕТОН



BE10

- Ø60 mm, дълбочина 49 mm
- 650° C, 500 V~
- в съответствие с IEC 60670-1
- без съдържание на халоген

ROUND BOX CONCRETE

- Ø60mm, depth 49mm
- 650° C, 500V~
- in accordance with IEC 60670-1
- halogen free

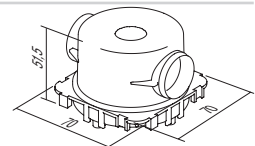

КРЪГЛИ ДЪЛБОКИ КОНЗОЛИ ЗА СТЕНИ ОТ БЕТОН



BE11

- Ø60 mm, дълбочина 58mm
- 650° C, 500 V~
- в съответствие с IEC 60670-1
- без съдържание на халоген

ROUND BOX CONCRETE DEEP

- Ø60mm, depth 58mm
- 650° C, 500V~
- in accordance with IEC 60670-1
- halogen free

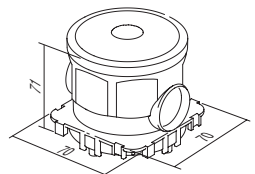

ЗАДНА ОПОРА ЗА КОНЗОЛА ЗА СТЕНИ ОТ БЕТОН



BE20

- за поддържане на конзоли за бетон с дистанционен профил BM82 срещу стената
- в съответствие с IEC 60670-1
- без съдържание на халоген

COUNTER BOX SUPPORT CONCRETE

- to support concrete boxes with discance profile BM82 for extreme loads
- in accordance with IEC 60670-1
- halogen free

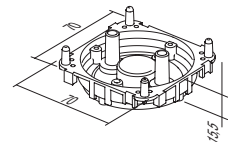

PIPE STOPPER CONCRETE BOX 16



BE21

- за закрепване на инсталационна тръба към конзола
- в съответствие с IEC 60670-1
- без съдържание на халоген

PIPE STOPPER CONCRETE BOX 16

- for firming installation pipe to box
- in accordance with IEC 60670-1
- halogen free

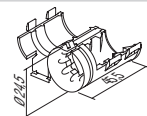

R O U N D B O X E S

кухи стени/ hollow walls



бетон/ concrete

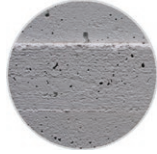

указания за сглобяване /
assembly instructions

разстояние между конзолите /
distance between boxes: 71mm

разстояние между конзолите /
distance between boxes: 91mm

HE10,11

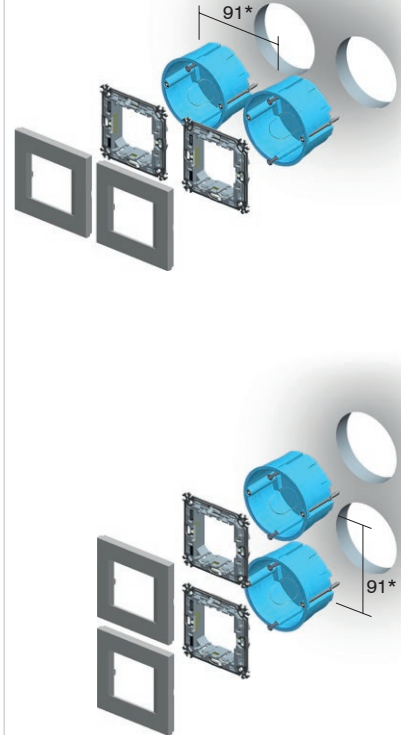
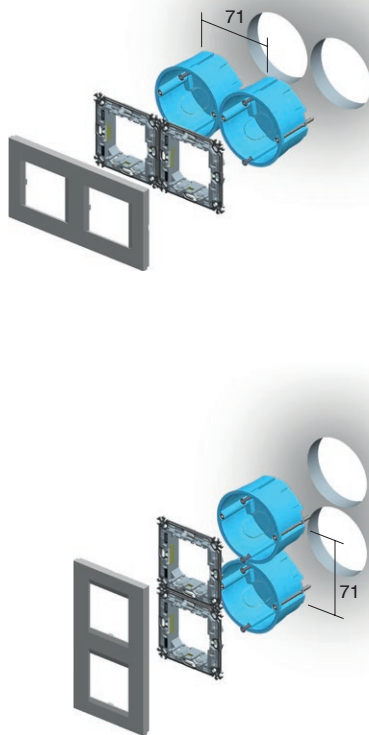
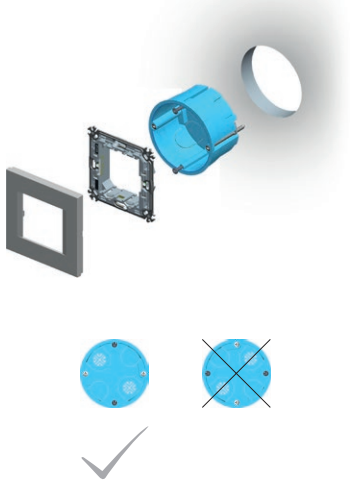

BE10

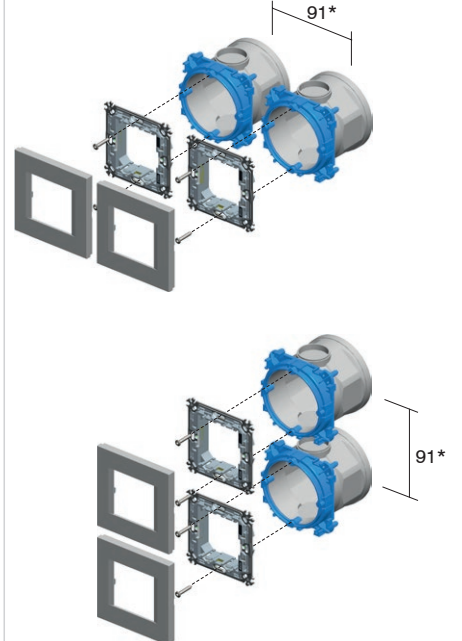
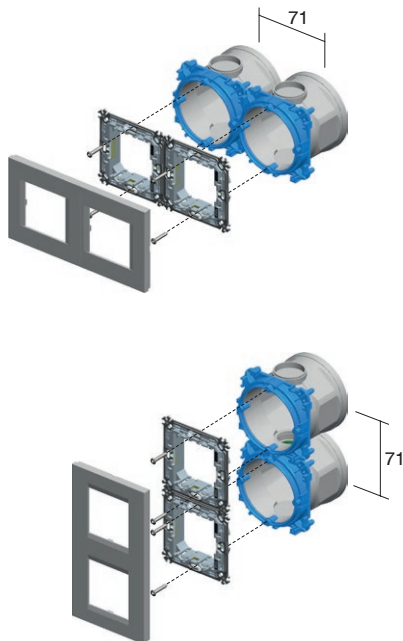
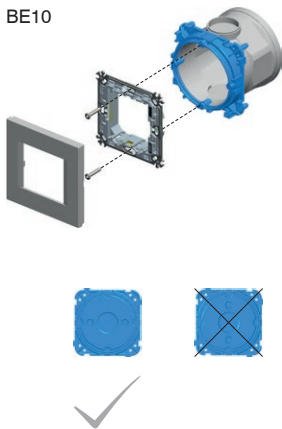

* за панелите PURE минималното разстояние между конзолите е 100 mm
* for PURE cover plates the minimum distance between boxes is 100mm

И
И
Т
К
К

кухи стени/ hollow walls



бетон/ concrete



HE10,11



BE10,11



NM21



NM25



2M

HE10,11



BE10,11



NM11



1/2M

2xHE10,11



2xBE10,11



2xNM21



2xNM25



2x2M

HE10,11



BE10,11



NM32



2/3M

2xHE10,11



2xBE10,11



2xNM21



2xNM25



5xHE10,11



5xNM21



5xBE10,11



5xNM25

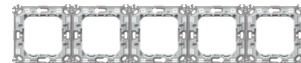

5x2M

3xHE10,11

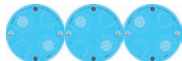

3xBE10,11



3xNM21



3xNM25



3x2M

3xHE10,11



3xBE10,11



3xNM21



3xNM25

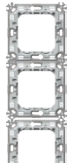

4xHE10,11



4xBE10,11



4xNM21



4xNM25



4x2M

4xHE10,11



4xBE10,11



4xNM21



4xNM25

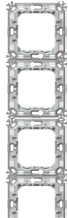

К
У
Т
И
И

R O U N D B O X E S

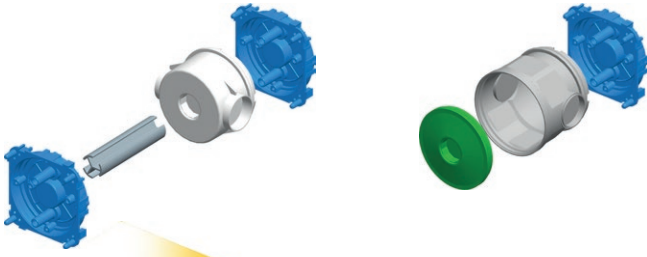

указания за сглобяване /
assembly instructions

1

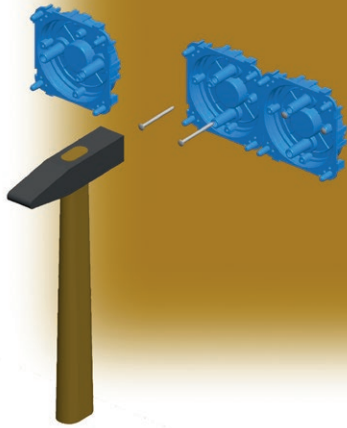

2

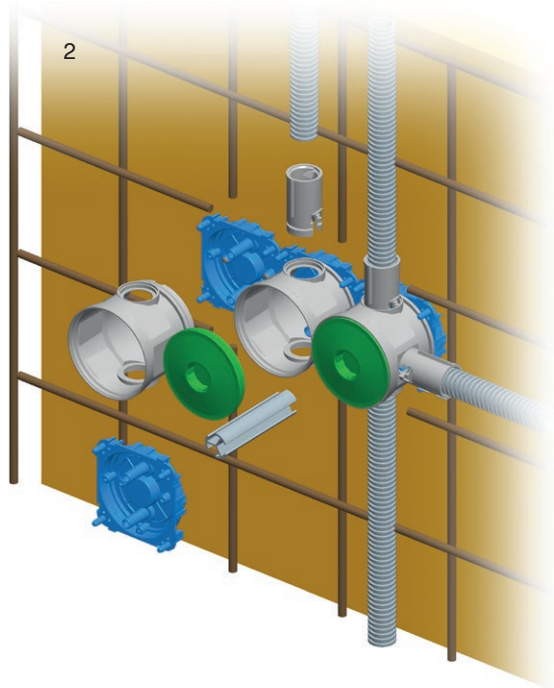

3

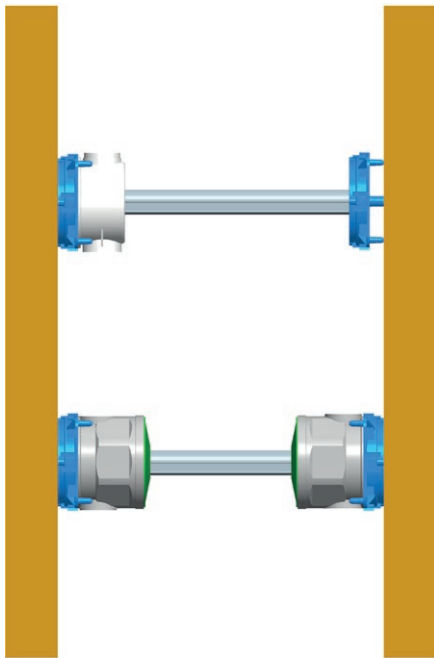

4

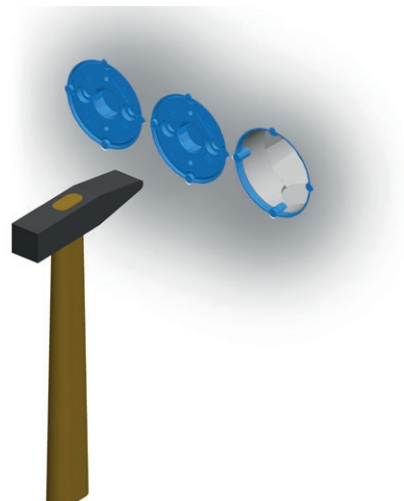

П Р А В О Ъ Г Ъ Л Н И К О Н З О Л И



DM30



HM30



BM30

тип type	описание description	размер size
DM30	ПРАВОЪГЪЛНА КОНЗОЛА ЗА ТУХЛЕНИ СТЕНИ <i>RECTANGULAR BOX BRICK</i>	PM3
HM30	ПРАВОЪГЪЛНА КОНЗОЛА ЗА КУХИ СТЕНИ <i>RECTANGULAR BOX HOLLOW WALL</i>	VM3
BM30	ПРАВОЪГЪЛНА КОНЗОЛА ЗА СТЕНИ ОТ БЕТОН <i>RECTANGULAR BOX CONCRETE</i>	BM3
·	·	·
·	·	·

ПРАВОЪГЪЛНА КОНЗОЛА ЗА ТУХЛЕНИ СТЕНИ PM3



DM30

- размер 3M, дълбочина 49 mm
- 650° C, 400V~
- в съответствие с IEC 60670-1
- без съдържание на халоген

RECTANGULAR BOX BRICK PM3

- size 3M, depth 49mm
- 650°C, 400V~
- in accordance with IEC 60670-1
- halogen free

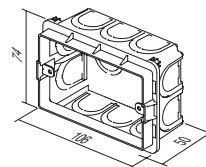

ПРАВОЪГЪЛНА КОНЗОЛА ЗА ТУХЛЕНИ СТЕНИ PM3-65



DM31

- размер 3M, дълбочина 65mm
- 650° C, 400V~
- в съответствие с IEC 60670-1
- без съдържание на халоген

RECTANGULAR BOX BRICK PM3-65

- size 3M, depth 65mm
- 650°C, 400V~
- in accordance with IEC 60670-1
- halogen free

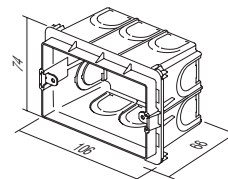

ПРАВОЪГЪЛНА КОНЗОЛА ЗА ТУХЛЕНИ СТЕНИ PM4



DM40

- размер 4M, дълбочина 49 mm
- 650° C, 400V~
- в съответствие с IEC 60670-1
- без съдържание на халоген

RECTANGULAR BOX BRICK PM4

- size 4M, depth 49mm
- 650°C, 400V~
- in accordance with IEC 60670-1
- halogen free

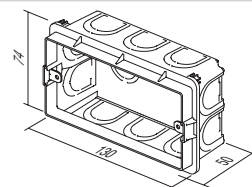

ПРАВОЪГЪЛНА КОНЗОЛА ЗА ТУХЛЕНИ СТЕНИ PM4-65



DM41

- размер 4M, дълбочина 65mm
- 650° C, 400V~
- в съответствие с IEC 60670-1
- без съдържание на халоген

RECTANGULAR BOX BRICK PM4-65

- size 4M, depth 65mm
- 650°C, 400V~
- in accordance with IEC 60670-1
- halogen free

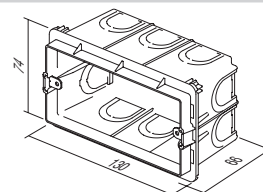

R E C T A N G U L A R B O X E S

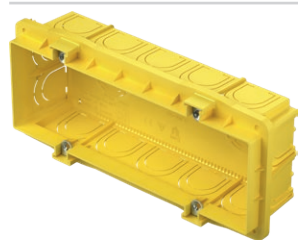

DM70

ПРАВОЪГЪЛНА КОНЗОЛА ЗА ТУХЛЕНИ СТЕНИ PM7

- размер 7М, дълбочина 49 mm
- 650° C, 400V~
- в съответствие с IEC 60670-1
- без съдържание на халоген

RECTANGULAR BOX BRICK PM7

- size 7M, depth 49mm
- 650°C, 400V~
- in accordance with IEC 60670-1
- halogen free

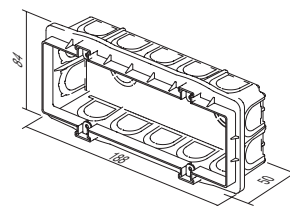

DM71

ПРАВОЪГЪЛНА КОНЗОЛА ЗА ТУХЛЕНИ СТЕНИ PM7-65

- размер 7М, дълбочина 65mm
- 650° C, 400V~
- в съответствие с IEC 60670-1
- без съдържание на халоген

RECTANGULAR BOX BRICK PM7-65

- size 7M, depth 65mm
- 650°C, 400V~
- in accordance with IEC 60670-1
- halogen free

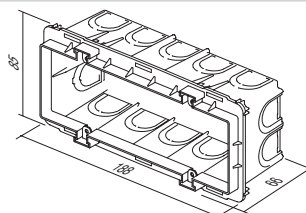

DM72

ПРАВОЪГЪЛНА КОНЗОЛА ЗА ТУХЛЕНИ СТЕНИ PM72-65

- размер 2x7М, дълбочина 64mm
- 650° C, 400V~
- в съответствие с IEC 60670-1
- без съдържание на халоген

RECTANGULAR BOX BRICK PM72-65

- size 2x7M, depth 64mm
- 650°C, 400V~
- in accordance with IEC 60670-1
- halogen free

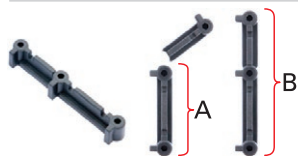
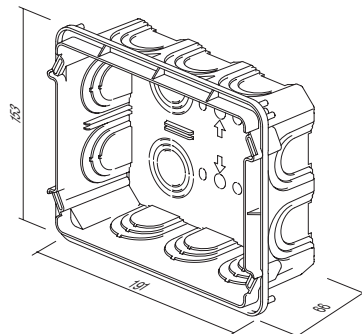

DM80

ДИСТАНЦИОНЕН ЕЛЕМЕНТ ЗА КОНЗОЛА PM

- за вертикален (A) и хоризонтален (B) монтаж на конзоли PM3, PM4 в PM7
- подходящ за декоративни панели LINE and SOFT (не за PURE)

DISTANCE PIECE FOR BOX PM

- for vertical (A) and horizontal (B) fitting of boxes PM3, PM4 and PM7
- suitable for Line and Soft decorative cover plates (not for PURE)

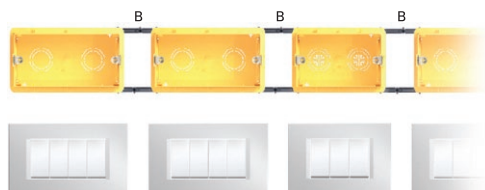
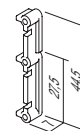



DM33

BOX COVER PROTECTIVE PM3

- защитно капаче за конзола PM3
- в съответствие с IEC 60670-1
- без съдържание на халоген
- за защита на конзолата по време на измазване

BOX COVER PROTECTIVE PM3

- protective cover for box PM3
- in accordance with IEC 60670-1
- halogen free
- box protection during plastering

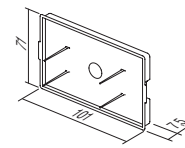

DM34

BOX COVER DECORATIVE PM3

- декоративно капаче за конзоли 3M
- винтовете са включени в доставката
- в съответствие с IEC 60670-1
- без съдържание на халоген

BOX COVER DECORATIVE PM3

- decorative cover for boxes 3M
- screws are included
- in accordance with IEC 60670-1
- halogen free

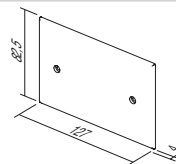

DM43

BOX COVER PROTECTIVE PM4

- защитно капаче за конзола PM4
- в съответствие с IEC 60670-1
- без съдържание на халоген
- за защита на конзолата по време на измазване

BOX COVER PROTECTIVE PM4

- protective cover for box PM4
- in accordance with IEC 60670-1
- halogen free
- box protection during plastering

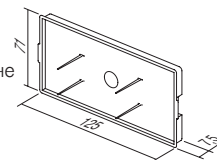

DM44

BOX COVER DECORATIVE PM4

- декоративно капаче за конзоли 4M
- винтовете са включени в доставката
- в съответствие с IEC 60670-1
- без съдържание на халоген

BOX COVER DECORATIVE PM4

- decorative cover for boxes 4M
- screws are included
- in accordance with IEC 60670-1
- halogen free

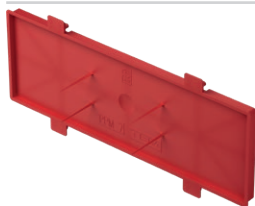
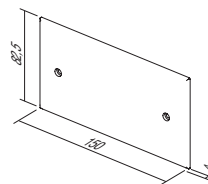

DM73

BOX COVER PROTECTIVE PM7

- защитно капаче за конзола PM7
- в съответствие с IEC 60670-1
- без съдържание на халоген
- за защита на конзолата по време на измазване

BOX COVER PROTECTIVE PM7

- protective cover for box PM7
- in accordance with IEC 60670-1
- halogen free
- box protection during plastering

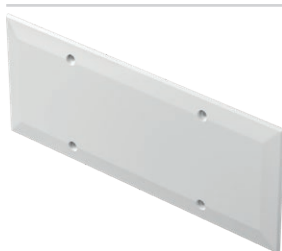
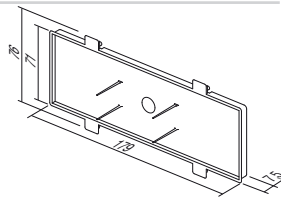

DM74

BOX COVER DECORATIVE PM7

- декоративно капаче за конзоли 7M
- винтовете са включени в доставката
- в съответствие с IEC 60670-1
- без съдържание на халоген

BOX COVER DECORATIVE PM7

- decorative cover for boxes 7M
- screws are included
- in accordance with IEC 60670-1
- halogen free

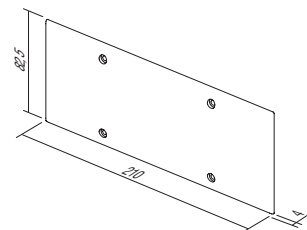

R E C T A N G U L A R B O X E S



DM75

BOX COVER DECORATIVE PM72

- декоративно капаче за конзоли 2x7M
- винтовете са включени в доставката
- в съответствие с IEC 60670-1

BOX COVER DECORATIVE PM72

- decorative cover for boxes 2x7M
- screws are included
- in accordance with IEC 60670-1

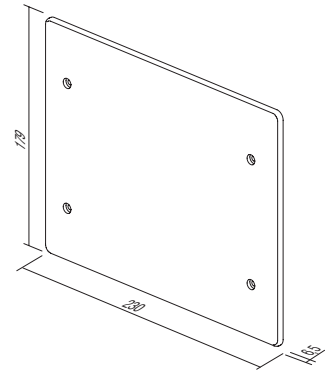



HM30

ПРАВОЪГЪЛНА КОНЗОЛА ЗА КУХИ СТЕНИ VM3

- размер 3M, дълбочина 49 mm
- прорязване на отвор 2xØ68/45 mm
- 850° C, 400 V[~]
- в съответствие с IEC 60670-1
- без съдържание на халоген

RECTANGULAR BOX HOLLOW WALL VM3

- size 3M, depth 49mm
- cutting hole 2xØ68/45mm
- 850°C, 400V[~]
- in accordance with IEC 60670-1
- halogen free

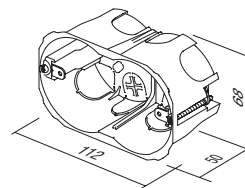

HM40

ПРАВОЪГЪЛНА КОНЗОЛА ЗА КУХИ СТЕНИ VM4

- размер 4M, дълбочина 49 mm
- прорязване на отвор 2xØ68/70 mm
- 850° C, 400 V[~]
- в съответствие с IEC 60670-1
- без съдържание на халоген

RECTANGULAR BOX HOLLOW WALL VM4

- size 4M, depth 49mm
- cutting hole 2xØ68/70mm
- 850°C, 400V[~]
- in accordance with IEC 60670-1
- halogen free

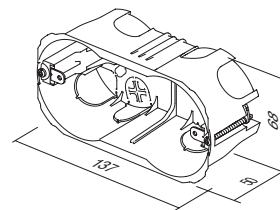

HM70

ПРАВОЪГЪЛНА КОНЗОЛА ЗА КУХИ СТЕНИ VM7

- размер 7M, дълбочина 49 mm
- прорязване на отвор 2xØ68/120 mm
- 850° C, 400 V[~]
- в съответствие с IEC 60670-1
- без съдържание на халоген

RECTANGULAR BOX HOLLOW WALL VM7

- size 7M, depth 49mm
- cutting hole 2xØ68/120mm
- 850°C, 400V[~]
- in accordance with IEC 60670-1
- halogen free

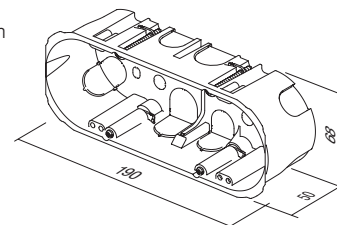

HM72

ПРАВОЪГЪЛНА КОНЗОЛА ЗА КУХИ СТЕНИ VM72







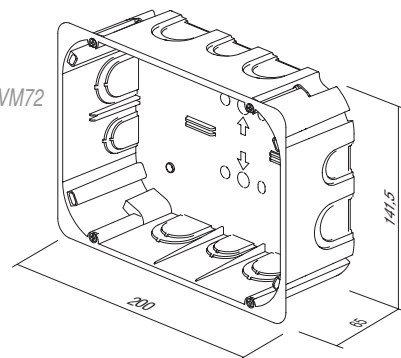

- размер 2x7M, дълбочина 63mm
- 850° C, 400 V[~]
- в съответствие с IEC 60670-1
- без съдържание на халоген

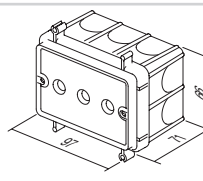
RECTANGULAR BOX HOLLOW WALL VM72

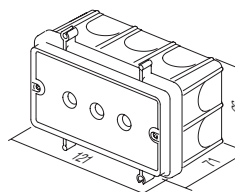
- size 2x7M, depth 63mm
- 850°C, 400V[~]
- in accordance with IEC 60670-1
- halogen free

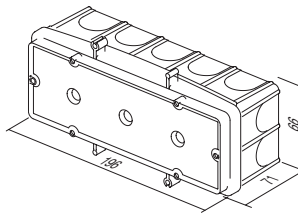

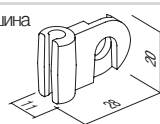
R E C T A N G U L A R B O X E S

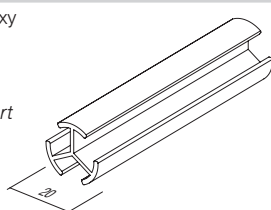
	BM30	ПРАВОЪГЪЛНА КОНЗОЛА ЗА СТЕНИ ОТ БЕТОН BM3	
		<ul style="list-style-type: none"> - размер 3M, дълбочина 60 mm - 650° C, 400V~ - в съответствие с IEC 60670-1 - без съдържание на халоген <p><i>RECTANGULAR BOX CONCRETE BM3</i></p> <ul style="list-style-type: none"> - size 3M, depth 60mm - 650° C, 400V~ - in accordance with IEC 60670-1 - halogen free 	
	BM40	ПРАВОЪГЪЛНА КОНЗОЛА ЗА СТЕНИ ОТ БЕТОН BM4	
		<ul style="list-style-type: none"> - размер 4M, дълбочина 60 mm - 650° C, 400V~ - в съответствие с IEC 60670-1 - без съдържание на халоген <p><i>RECTANGULAR BOX CONCRETE BM4</i></p> <ul style="list-style-type: none"> - size 4M, depth 60mm - 650° C, 400V~ - in accordance with IEC 60670-1 - halogen free 	
	BM70	ПРАВОЪГЪЛНА КОНЗОЛА ЗА СТЕНИ ОТ БЕТОН BM7	
		<ul style="list-style-type: none"> - размер 7M, дълбочина 60 mm - 650° C, 400V~ - в съответствие с IEC 60670-1 - без съдържание на халоген <p><i>RECTANGULAR BOX CONCRETE BM7</i></p> <ul style="list-style-type: none"> - size 7M, depth 60mm - 650° C, 400V~ - in accordance with IEC 60670-1 - halogen free 	
	BM80	FIXING COMBI-CLIP BM	
		<ul style="list-style-type: none"> - за бързо закрепване правоъгълни конзоли BM върху подсилваща шина - подходящо за пръти с диаметър до Ø8 mm <p><i>FIXING COMBI-CLIP BM</i></p> <ul style="list-style-type: none"> - for fast fixation of BM rectangular boxes on reinforcing bar - suitable for bar diameter up to Ø8mm 	
	BM82	ДИСТАНЦИОНЕН ПРОФИЛ ЗА КОНЗОЛИ BM	
		<ul style="list-style-type: none"> - за поддържане на конзоли BM с опора върху стената - дължина l=1 m, диаметър Ø20 mm <p><i>DISTANCE PROFIL FOR BOXES BM</i></p> <ul style="list-style-type: none"> - to support boxes BM with counter box support on opposite wall - length l=1m, diameter Ø20mm 	

П Р А В О Ъ Г Ъ Л Н И К О Н З О Л И



тухла/ brick

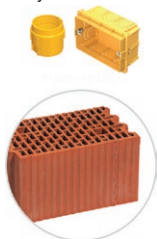

кухи стени/ hollow walls

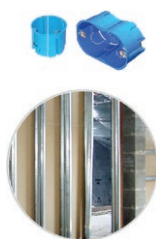

бетон/ concrete

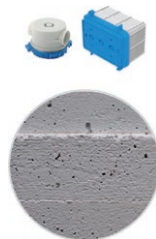

К
У
Т
И
И

DM30   **NM30**

HM30  ————

BM30 



3M

DM40   **NM40**

HM40  ————

BM40 

4M

DM70   **NM70**

HM70  ————

BM70 

7M

DM72   **NM72**

HM72  ————

2x7M

DM30   **NM32**

HM30  ————

BM30 

2/3M

R E C T A N G U L A R B O X E S

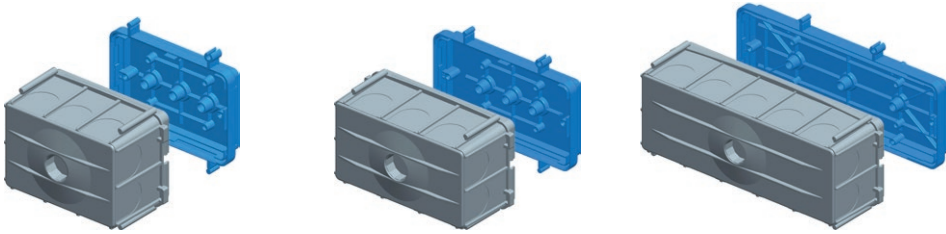

указания за сглобяване /
assembly instructions

1

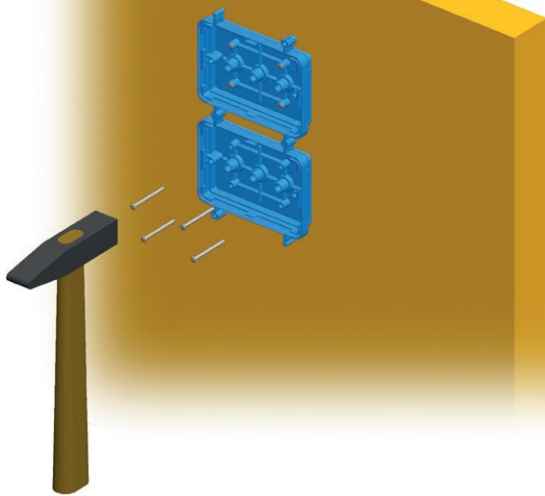

2

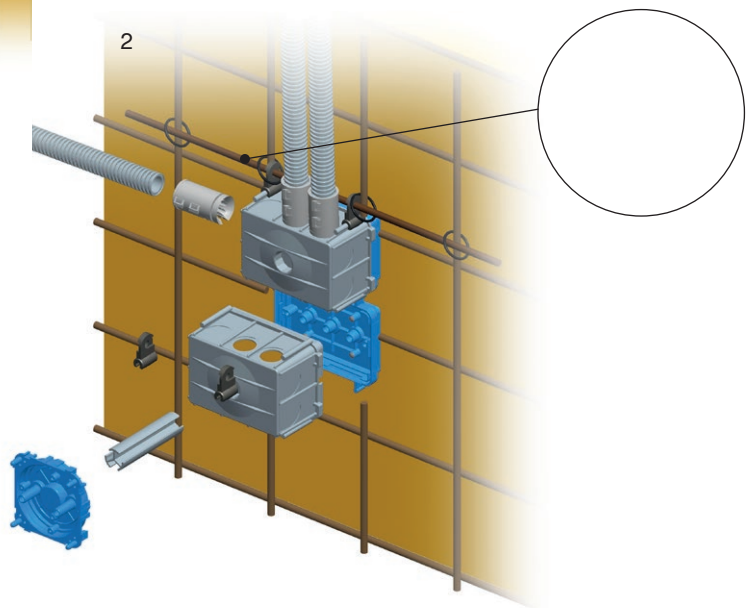

3

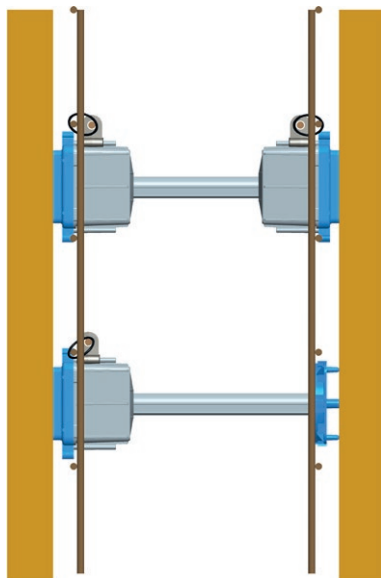

4

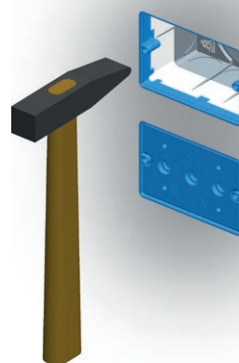



DW10

КРЪГЛА СЪЕДИНИТЕЛНА КОНЗОЛА ЗА ТУХЛЕНИ СТЕНИ DSM78

- Ø78, дълбочина 40 mm
- 650° C, 500 V~
- в съответствие с IEC 60670-1 и IEC 60670-22
- без съдържание на халоген

CONNECTION ROUND BOX BRICK DSM78

- Ø78, depth 40mm
- 650°C, 500V~
- in accordance with IEC 60670-1 and IEC 60670-22
- halogen free

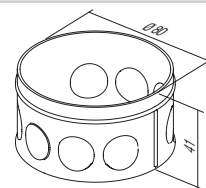

HW10

КРЪГЛА СЪЕДИНИТЕЛНА КОНЗОЛА ЗА КУХИ СТЕНИ SM78x45

- Ø78, дълбочина 45 mm
- прорязване на отвор Ø80
- 850° C, 400 V~
- в съответствие с IEC 60670-1 и IEC 60670-22
- монтаж с крачета
- без съдържание на халоген

CONNECTION ROUND BOX HOLLOW WALL SM78x45

- Ø78, depth 45mm
- cutting hole Ø80
- 850°C, 400V~
- in accordance with IEC 60670-1 and IEC 60670-22
- mounting with claws
- halogen free

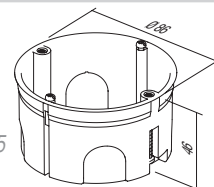

DE23

BOX COVER SM78

- декоративно капаче за конзоли Ø78
- в съответствие с IEC 60670-1 и IEC 60670-22
- без съдържание на халоген

BOX COVER DECORATIVE SM78

- decorative cover for boxes Ø78
- in accordance with IEC 60670-1 and IEC 60670-22
- halogen free

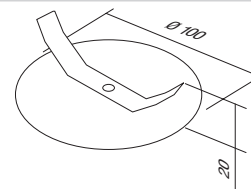

DE24

BOX COVER PROTECTIVE 78

- защитно капаче за конзола Ø78
- в съответствие с IEC 60670-1 и IEC 60670-22
- без съдържание на халоген

BOX COVER PROTECTIVE 78

- protective cover for box Ø78
- in accordance with IEC 60670-1 and IEC 60670-22
- halogen free

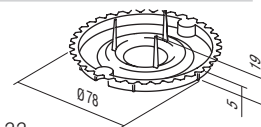

HW20

КВАДРАТНА СЪЕДИНИТЕЛНА КОНЗОЛА ЗА ТУХЛЕНИ СТЕНИ SM105x105

- размер 105x105mm, дълбочина 50 mm
- прорязване на отвор с приложения шаблон
- 850° C, 400 V~
- в съответствие с IEC 60670-1 и IEC 60670-22
- монтаж с крачета
- без съдържание на халоген

CONNECTION SQUARE BOX BRICK SM105x105

- size 105x105mm, depth 50mm
- cutting hole according to attached template
- 850°C, 400V~
- in accordance with IEC 60670-1 and IEC 60670-22
- mounting with claws
- halogen free

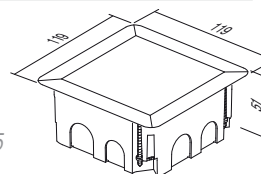

J U N C T I O N B O X E S

K
Y
T
N
N

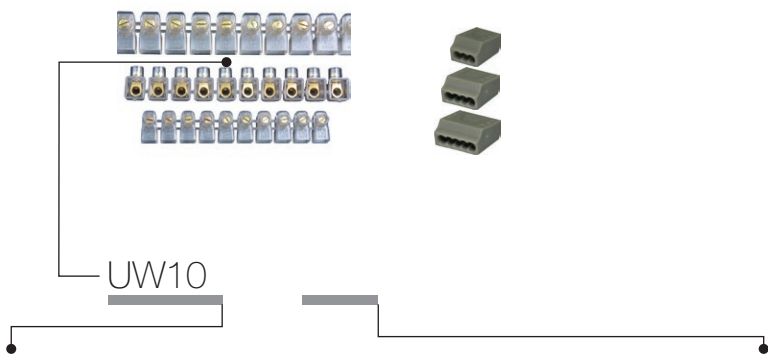

тип type	описание description	технически данни technical data	размер size	цвет colour
UW10	1 РЕД КЛЕМОРЕДИ ЗАТВОРЕНИ 1 ROW TERMINAL BLOCKS	2x2.5mm ²	10P	TS прозрачен transparent
UW11	1 РЕД КЛЕМОРЕДИ ЗАТВОРЕНИ 1 ROW TERMINAL BLOCKS	2x4mm ²	10P	CO цвет colour
UW12	1 РЕД КЛЕМОРЕДИ ЗАТВОРЕНИ 1 ROW TERMINAL BLOCKS	2x6mm ²	10P	WH бял цвет white
·	·	·	·	GY сив grey

1 РЕД КЛЕМОРЕДИ ЗАТВОРЕНИ



- 450 V~; 2x2,5 mm² ÷ 2x6 mm²
- термопласт PC, прозрачен
- брой полюси: 10

1 ROW TERMINAL BLOCKS CLOSED

- 450V~; 2x2.5mm² ÷ 2x6mm²
- thermoplast PC, transparent
- number of poles: 10

UW10TS	(NS12)	2x2.5mm ²	10P
UW11TS	(NS12)	2x4mm ²	10P
UW12TS	(NS12)	2x6mm ²	10P

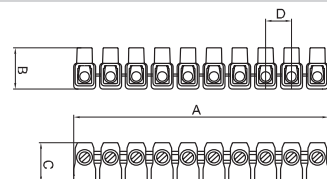

	A	B	C	D
2x2.5 □	110	17.5	17.5	11
2x4 □	128	21	19	12.5
2x6 □	146	21.5	22	15

1 РЕД КЛЕМОРЕДИ

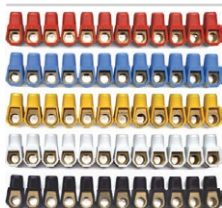

- 450 V~; 2x2,5 mm² ÷ 2x6 mm²
- термопласт PA
- предлага се в различни цветове
- брой полюси: 12

1 ROW TERMINAL BLOCKS

- 450V~; 2x2.5mm² ÷ 2x6mm²
- thermoplast PA
- available in different colours
- number of poles: 12

UW15CO	(NS12)	2x2.5mm ²	12P
UW16CO	(NS12)	2x4mm ²	12P
UW17CO	(NS12)	2x6mm ²	12P

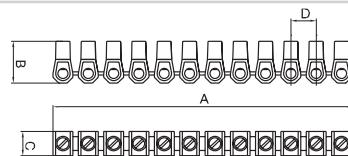

	A	B	C	D
2x2.5 □	110	16.4	9	10
2x4 □	118.8	19	10	10
2x6 □	129.8	21.3	11	11.8

2 РЕДА КЛЕМОРЕДИ PP

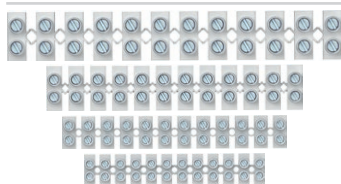

- 450 V~; 1 mm² ÷ 16 mm²
- термопласт полипропилен PP, бял
- за температури до 80°C
- брой полюси: 12

2 ROW TERMINAL BLOCKS PP

- 450V~; 1mm² ÷ 16mm²
- thermoplast polypropylene PP, white
- for temperatures up to 80°C
- number of poles: 12

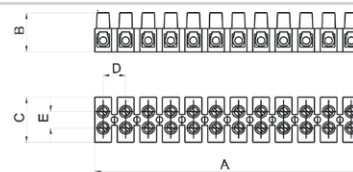

					A	B	C	D	E
UW29WHPP	1.0-4.0mm ²	24 A	450 V		94,9	13	16,6	8,1	6,4
UW30WHPP	1.5-6.0mm ²	32 A	450 V		116,5	14,9	18,9	10	7,3
UW31WHPP	2.5-10mm ²	41 A	450 V		133,8	17,3	23,4	11,5	10
UW32WHPP	4-16mm ²	76 A	450 V		174,5	20,7	25	15	11

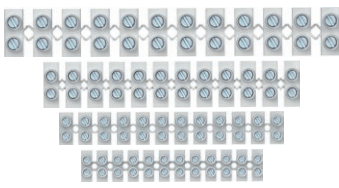
**2 РЕДА КЛЕМОРЕДИ РА**

- 450 V \sim ; 1 mm² ÷ 16 mm²
- термопласт полиамид РА, бял
- за температури до 110° C
- брой полюси: 12

2 ROW TERMINAL BLOCKS PA

- 450V \sim ; 1mm² ÷ 16mm²
- thermoplast polyamide PA, white
- for temperatures up to 110° C
- number of poles: 12

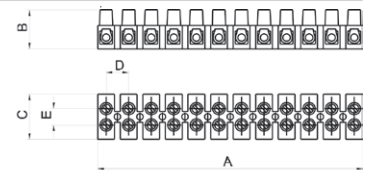

					A	B	C	D	E
UW25WHPA	1.0-4.0mm ²	24 A	450 V		93,6	13,4	16,2	8	6,4
UW26WHPA	1.5-6.0mm ²	32 A	450 V		117	15	18,6	10	7,3
UW27WHPA	2.5-10mm ²	41 A	450 V		132,8	17,3	22,2	11,5	10
UW28WHPA	4-16mm ²	76 A	450 V		173,9	20,8	25,2	15	11

СЪЕДИНИТЕЛИ С ВКАРВАНЕ НА ПРОВОДНИЦИТЕ

- 24 A 450 V \sim , термопласт РА, сив
- брой полюси: 3÷8
- контакти чрез вкарване 0,5÷1,5 mm², за твърди проводници
- в съответствие с EN 60998-1

PLUG-IN WIRE CONNECTORS

- 24A 450V \sim , thermoplast PA, grey
- number of poles: 3÷8
- plug-in contacts 0.5÷1.5mm², for rigide wires
- in accordance with EN 60998-1



UW40GY	PC153	1.5mm ²	3P	3P	A 12	B 18	C 9
UW41GY	PC155	1.5mm ²	5P	5P	17	18	9
UW42GY	PC158	1.5mm ²	8P	8P	26	18	9

СЪЕДИНИТЕЛИ С ВКАРВАНЕ НА ПРОВОДНИЦИТЕ

- 24 A 450 V \sim , термопласт РА, сив
- брой полюси: 3÷5
- контакти чрез вкарване 1,5÷2,5 mm², за твърди проводници
- в съответствие с EN 60998-1

PLUG-IN WIRE CONNECTORS

- 24A 450V \sim , thermoplast PA, grey
- number of poles: 3÷5
- plug-in contacts 1.5÷2.5mm², for rigide wires
- in accordance with EN 60998-1

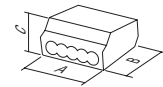

UW45GY	PC253	2.5mm ²	3P	3P	A 14	B 19	C 9
UW46GY	PC254	2.5mm ²	4P	4P	17	19	9
UW47GY	PC255	2.5mm ²	5P	5P	21	19	9

СЪЕДИНИТЕЛ С ВКАРВАНЕ НА ПРОВОДНИЦИТЕ

- 24 A 450 V \sim , термопласт РА, сив
- брой полюси: 2 (твърд проводник)+1 (мек проводник)
- контакти чрез вкарване 1,5÷2,5 mm²
- в съответствие с EN 60998-1

PLUG-IN WIRE CONNECTOR

- 24A 450V \sim , thermoplast PA, grey
- number of poles: 2 (rigide wire)+1 (soft wire)
- plug-in contacts 1.5÷2.5mm²
- in accordance with EN 60998-1

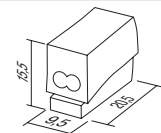

UW50WH	PC302	2.5mm ²	2/1P
--------	-------	--------------------	------

TEM

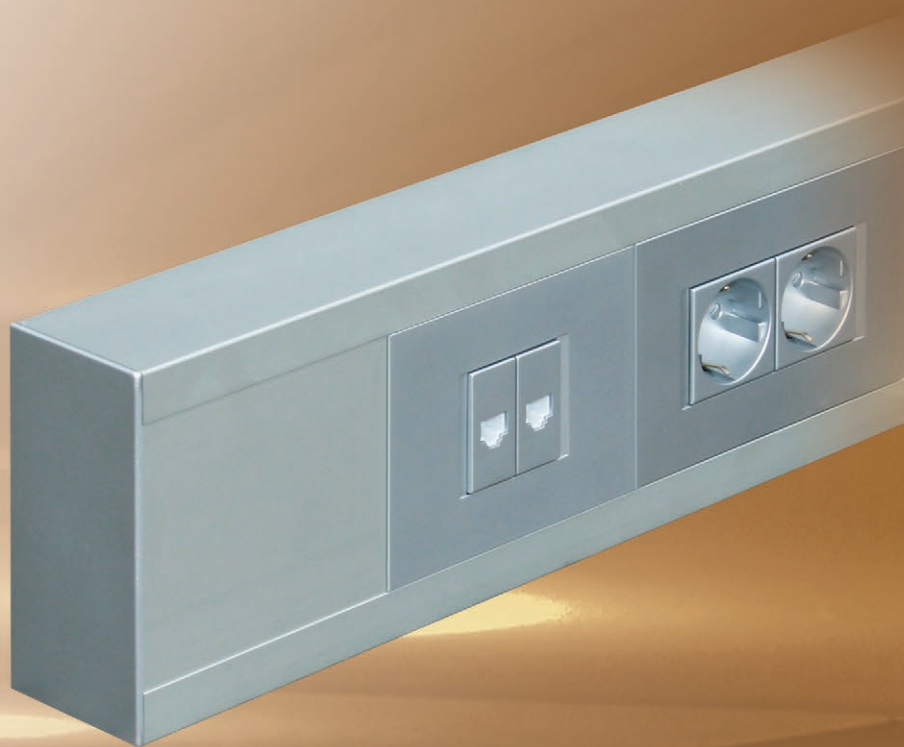

КАТАЛОГ /
CATALOGUE

разпределение



<p>КОНЗОЛИ CUBO IP20 AC <i>BOXES CUBO IP20 AC</i></p>		162
<p>КОНЗОЛИ CUBO IP55 AQ <i>BOXES CUBO IP55 AQ</i></p>		163
<p>СИСТЕМА ЗА КАНАЛ ЗА КАБЕЛИ МА <i>TRUNKING SYSTEM ALUMINIUM MA</i></p>		165
<p>ПОДОВИ КОНЗОЛИ МТ <i>FLOOR BOXES MT</i></p>		171
<p>РАЗПРЕДЕЛИТЕЛНИ ТАБЛА МО <i>DISTRIBUTION BOARDS MO</i></p>		173

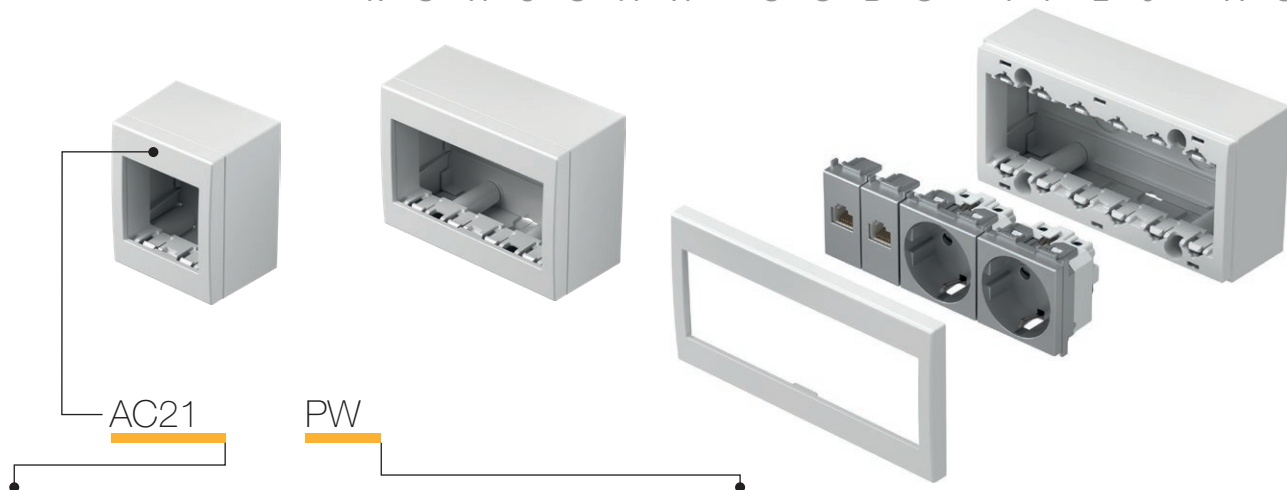

тип type	описание description	технически данни technical data	размер size	цвет colour
AC11	КОНЗОЛА NO CUBO СЪС ЗАДЕН КАПАК SURFACE MOUNT BOX WITH BACK SIDE COVER	IP20	1M	<input type="checkbox"/> PW снежнобял цвят polar white <input type="checkbox"/> ES сребрист цвят с анодизирано покритие elox silver
AC21	КОНЗОЛА NO CUBO СЪС ЗАДЕН КАПАК SURFACE MOUNT BOX WITH BACK SIDE COVER	IP20	2M	<input type="checkbox"/> IW слонова кост ivory white
AC41	КОНЗОЛА NO CUBO СЪС ЗАДЕН КАПАК SURFACE MOUNT BOX WITH BACK SIDE COVER	IP20	4M	

разпределение

КОНЗОЛА NO CUBO СЪС ЗАДЕН КАПАК IP20 1M



- AC11PW
- AC11ES
- AC11IW

- конзола IP20 1M
- за външен монтаж на елементи
- подходяща за ключове SM
- в съответствие с EN 60669-1

BOX NO CUBO WITH BACK SIDE COVER IP20 1M
- box IP20 1M
- for surface mounting of elements
- suitable to SM switches
- in accordance with EN 60669-1



КОНЗОЛА NO CUBO СЪС ЗАДЕН КАПАК IP20 2M



- AC21PW
- AC21ES
- AC21IW

- конзола IP20 2M
- за външен монтаж на елементи
- в съответствие с EN 60669-1, EN60884-1

BOX NO CUBO WITH BACK SIDE COVER IP20 2M
- box IP20 2M
- for surface mounting of elements
- in accordance with EN 60669-1, EN60884-1



КОНЗОЛА NO CUBO СЪС ЗАДЕН КАПАК IP20 4M



- AC41PW
- AC41ES
- AC41IW

- конзола IP20 4M
- за външен монтаж на елементи
- в съответствие с EN 60669-1, EN60884-1

BOX NO CUBO WITH BACK SIDE COVER IP20 4M
- box IP20 4M
- for surface mounting of elements
- in accordance with EN 60669-1, EN60884-1



КОНЗОЛА NO CUBO СЪС ЗАДЕН КАПАК IP20 6M



- AC61PW
- AC61ES
- AC61IW

- конзола IP20 6M
- за външен монтаж на елементи
- в съответствие с EN 60669-1, EN60884-1

BOX NO CUBO WITH BACK SIDE COVER IP20 6M
- box IP20 6M
- for surface mounting of elements
- in accordance with EN 60669-1, EN60884-1

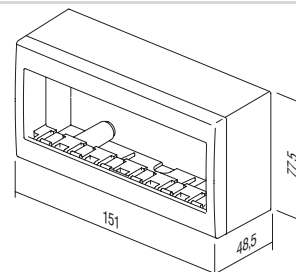
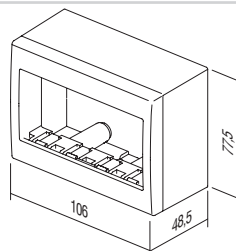
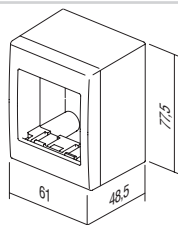
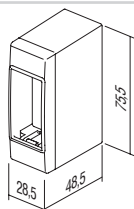

B O X E S C U B O I P 5 5 A Q

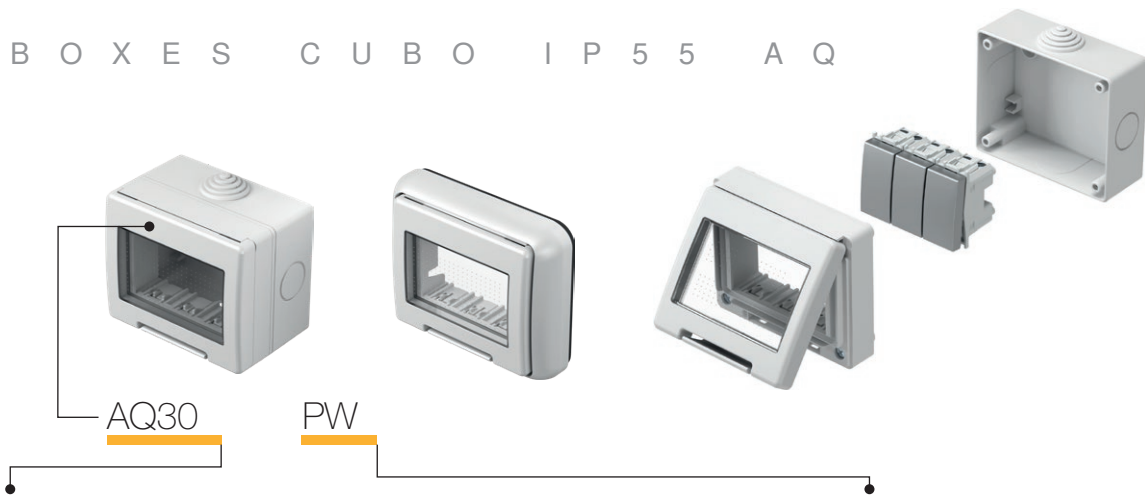

тип type	описание description	технически данни technical data	размер size	цвет colour
AQ20	КОНЗОЛА NO CUBO OUTDOOR SURFACE MOUNT BOX	IP55	2M	<input type="checkbox"/> PW снежнобял цвят polar white
AQ22	КОНЗОЛА NO CUBO OUTDOOR SURFACE MOUNT BOX	IP55	2x2M	<input checked="" type="checkbox"/> GY сив grey
AQ30	КОНЗОЛА NO CUBO OUTDOOR SURFACE MOUNT BOX	IP55	3M	
AQ31	КОНЗОЛА PO CUBO OUTDOOR SURFACE MOUNT BOX	IP55	3M	

КОНЗОЛА NO CUBO IP55 2M



- AQ20PW
- AQ20GY

- конзола IP55 2M
- за външен монтаж
- IP55 за използване във влажни зони
- в съответствие с IEC 23-48, CEI 60670

BOX NO CUBO IP55 2M

- box IP55 2M
- for surface mounting
- IP55 for usage in humid areas
- in accordance with CEI 23-48, EN 60670



КОНЗОЛА NO CUBO IP55 2x2M



- AQ22PW
- AQ22GY

- конзола IP55 2x2M
- за външен монтаж
- IP55 за използване във влажни зони
- в съответствие с IEC 23-48, CEI 60670

BOX NO CUBO IP55 2x2M

- box IP55 2x2M
- for surface mounting
- IP55 for usage in humid areas
- in accordance with CEI 23-48, EN 60670



КОНЗОЛА NO CUBO IP55 3M



- AQ30PW
- AQ30GY

- конзола IP55 3M
- за външен монтаж
- IP55 за използване във влажни зони
- в съответствие с IEC 23-48, CEI 60670

BOX NO CUBO IP55 3M

- box IP55 3M
- for surface mounting
- IP55 for usage in humid areas
- in accordance with CEI 23-48, EN 60670





□ AQ21PW

КУТИЯ ПО СУВО IP55 2M

- кутия IP55 2M
- може да се съчетава с функционални елементи на Modul
- за вграден монтаж
- IP55 за употреба в помещения с наличие на влага
- в съответствие със CEI 23-48, EN 60670

BOX PO СУВО IP55 2M

- box IP55 2M
- can be combined with all Modul functional elements
- for flush mounting
- IP55 for usage in humid areas
- in accordance with CEI 23-48, EN 60670



□ AQ31PW
■ AQ31GY

КОНЗОЛА ПО СУВО IP55 3M

- конзола IP55 3M
- за скрит монтаж
- IP55 за използване във влажни зони
- в съответствие с IEC 23-48, CEI 60670

BOX PO СУВО IP55 3M

- box IP55 3M
- for flush mounting
- IP55 for usage in humid areas
- in accordance with CEI 23-48, EN 60670

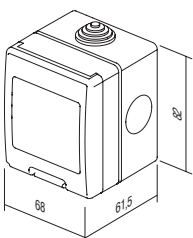

AQ20

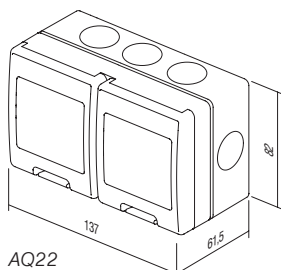

AQ22

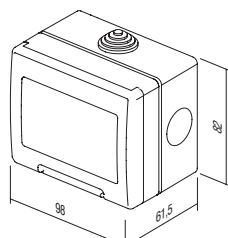

AQ30

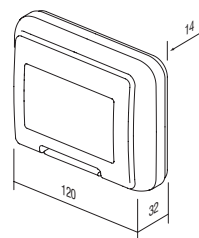

AQ31

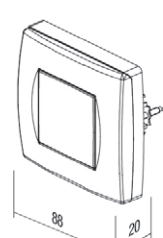

AQ21

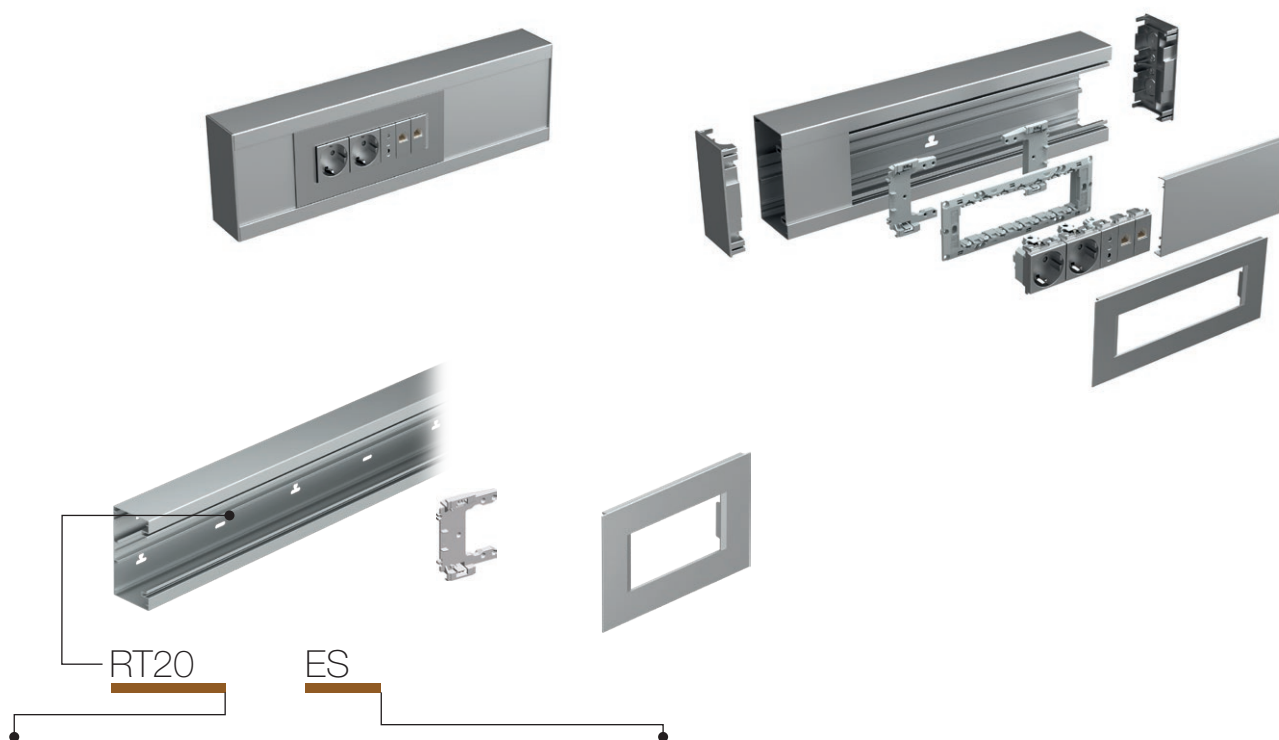

тип type	описание description	размер size	цвет colour
RT10	АДАПТЕР MA 92 ADAPTER MA 92	/	■ ES сребрист цвят с анодизирано покритие elox silver-mat
RT12	ПАНЕЛ MA 92 COVER PLATE MA 92	2/3M	□ PW бял матов (RAL 9016) white-mat
RT14	ПАНЕЛ MA 92 COVER PLATE MA 92	4M	
⋮	⋮	⋮	

АДАПТЕР MA 92



RT10

- адаптер за закрепване за монтажни рамки 2/3M, 4M или 7M върху канал MA без конзола
- за всяка монтажна рамка са нужни два адаптера
- в съответствие с EN 50085-1

ADAPTER MA 92

- adapter for fixing mounting frames 2/3M, 4M or 7M on MA trunking without box
- each mounting frame needs two adapters
- in accordance with EN 50085-1



ПАНЕЛ MA 92 2/3M



■ RT12ES
□ RT12PW

- декоративен панел MA 2/3M
- в съответствие с EN 50085-1

COVER PLATE MA 92 2/3M

- decorative cover plate MA 2/3M
- in accordance with EN 50085-1

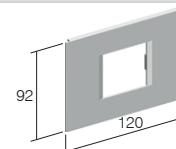

ПАНЕЛ MA 92 4M



■ RT14ES
□ RT14PW

- декоративен панел MA 4M
- в съответствие с EN 50085-1

COVER PLATE MA 92 4M

- decorative cover plate MA 4M
- in accordance with EN 50085-1

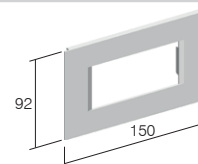

ПАНЕЛ MA 92 7M



■ RT17ES
□ RT17PW

- декоративен панел MA 7M
- в съответствие с EN 50085-1

COVER PLATE MA 92 7M

- decorative cover plate MA 7M
- in accordance with EN 50085-1

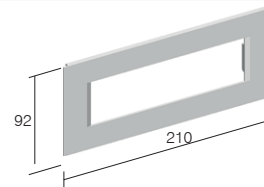

ОСНОВА ЗА КАНАЛ МА 130x65



- RT20ES
- RT20PW

- основа за канал от екструдиран алуминий
- височина 130 mm, дължина 2 m
- DIN – релса 35 mm долен профил
- в съответствие с EN 50085-1

TRUNKING BASE MA 130x65

- trunking base from extruded aluminium
- height 130mm, length 2m
- DIN - rail 35mm shape on bottom
- in accordance with EN 50085-1

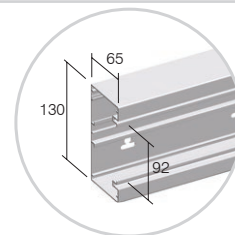

ОСНОВА ЗА КАНАЛ МА 165x65



- RT21ES
- RT21PW

- основа за канал от екструдиран алуминий
- височина 165 mm, дължина 2 m
- DIN – релса 35 mm долен профил
- в съответствие с EN 50085-1

TRUNKING BASE MA 165x65

- trunking base from extruded aluminium
- height 165mm, length 2m
- DIN - rail 35mm shape on bottom
- in accordance with EN 50085-1

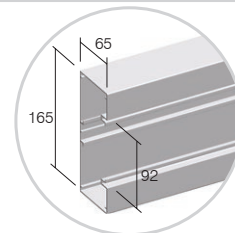

ПРЕДЕН КАПАК МА 92



- RT25ES
- RT25PW

- преден капак от екструдиран алуминий
- височина 92mm, дължина 2 m
- в съответствие с EN 50085-1

FRONT COVER MA 92

- front cover from extruded aluminium
- height 92mm, length 2m
- in accordance with EN 50085-1

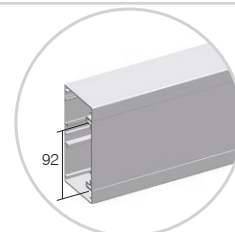

КАБЕЛНА СКАРА МА 43



RT30

- кабелна скара от екструдиран полимер
- дълбочина 43 mm, дължина 2 m
- в съответствие с EN 50085-1

CABLE SHELF MA 43

- cable shelf from extruded polymer
- depth 43mm, length 2m
- in accordance with EN 50085-1

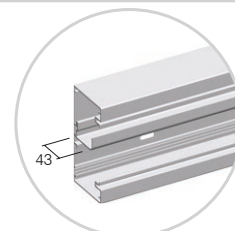

КАБЕЛНА СКАРА МА 43 AL



RT31

- кабелна скара от екструдиран алуминий
- дълбочина 43 mm, дължина 2 m
- в съответствие с EN 50085-1

CABLE SHELF MA 43 AL

- cable shelf from extruded aluminium
- depth 43mm, length 2m
- in accordance with EN 50085-1

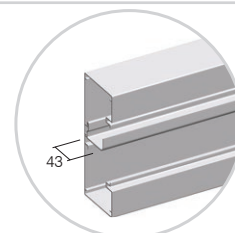

ДВОЙНА КАБЕЛНА СКАРА МА 43 AL



RT32

- двойна кабелна скара от екструдиран алуминий
- дълбочина 43 mm, дължина 2 m
- в съответствие с EN 50085-1

CABLE SHELF MA 43 AL DOUBLE

- double cable shelf from extruded aluminium
- depth 43mm, length 2m
- in accordance with EN 50085-1

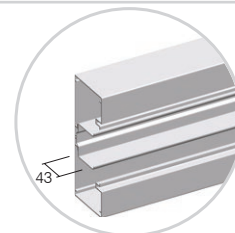

	<input checked="" type="checkbox"/> RT35ES <input type="checkbox"/> RT35PW	КРАЕН ЕЛЕМЕНТ МА 130x65	<ul style="list-style-type: none"> - краен елемент от полимер - височина 130 mm - в съответствие с EN 50085-1 	
	<input checked="" type="checkbox"/> RT36ES <input type="checkbox"/> RT36PW	КРАЕН ЕЛЕМЕНТ МА 165x65	<ul style="list-style-type: none"> - метален краен елемент - височина 165mm - в съответствие с EN 50085-1 	
	RT38	КОМПЛЕКТ СЪЕДИНИТЕЛЕН ЕЛЕМЕНТ МА 65	<ul style="list-style-type: none"> - съединителен елемент от полимер - комплектът съдържа два елемента и винтове - в съответствие с EN 50085-1 	
	<input checked="" type="checkbox"/> RT40ES <input type="checkbox"/> RT40PW	УНИВЕРСАЛЕН ТЪГЛОВ ЕЛЕМЕНТ МА 130x65	<ul style="list-style-type: none"> - универсален ъглов елемент - височина 130 mm - в съответствие с EN 50085-1 	
	<input checked="" type="checkbox"/> RT41ES <input type="checkbox"/> RT41PW	УНИВЕРСАЛЕН ТЪГЛОВ ЕЛЕМЕНТ МА 165x65	<ul style="list-style-type: none"> - универсален ъглов елемент - височина 165mm - в съответствие с EN 50085-1 	
	RT42	ЗАЗЕМИТЕЛЕН ЕЛЕМЕНТ МА 2 x A6.3	<ul style="list-style-type: none"> - заземителен елемент за заземяване на основата на канала и предния капак - в съответствие с EN 50085-1 	

L-КОЛЯНО MA 130x65



- RT43ES
- RT43PW

- универсален елемент- L-коляно от алуминий
- височина 130 mm, дължина 400 mm
- в съответствие с EN 50085-1

L-BEND MA 130x65

- universal L bend element from aluminium
- height 130mm, length 400mm
- in accordance with EN 50085-1

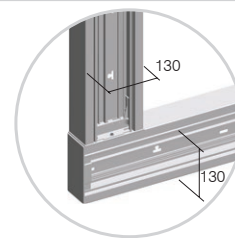

L-КОЛЯНО MA 165x65



- RT44ES
- RT44PW

- универсален елемент- L-коляно от алуминий
- височина 165 mm, дължина 400 mm
- свързване с MA 130x65
- в съответствие с EN 50085-1

L-BEND MA 165x65

- universal L bend element from aluminium
- height 165mm, length 400mm
- connection on MA 130x65
- in accordance with EN 50085-1

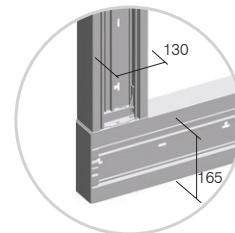

T-КОЛЯНО MA 130x65



- RT45ES
- RT45PW

- универсален елемент- T-коляно от алуминий
- височина 130 mm, дължина 400 mm
- в съответствие с EN 50085-1

T-BEND MA 130x65

- universal T bend element from aluminium
- height 130mm, length 400mm
- in accordance with EN 50085-1

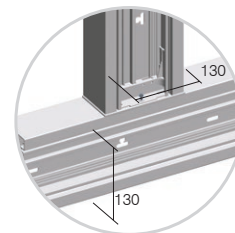

T-КОЛЯНО MA 165x65

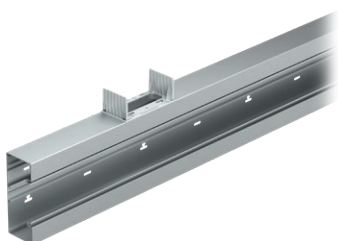

- RT46ES
- RT46PW

- универсален елемент- T-коляно от алуминий
- височина 165 mm, дължина 400 mm
- свързване с MA 130x65
- в съответствие с EN 50085-1

T-BEND MA 165x65

- universal T bend element from aluminium
- height 165mm, length 400mm
- connection on MA 130x65
- in accordance with EN 50085-1

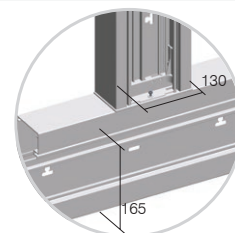

каналите MA се основават на модулна система за 2M, 4M или 7M комбинации от елементи

MA trunking is based on modular system making 2M, 4M or 7M combinations of elements

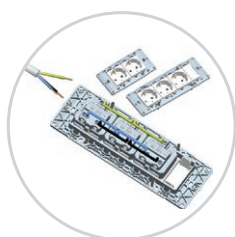

В Modul ние предоставяме специални елементи за бърз монтаж

In Modul we provide special elements for quick installation

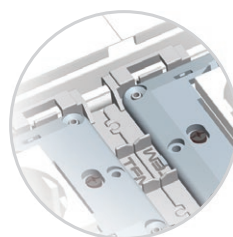

C Adapter MA се предоставя точно позициониране без излишни усилия

With Adapter MA exact positioning without extra effort is provided

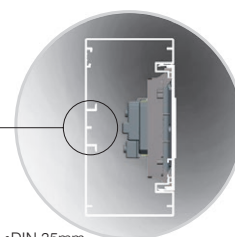

Монтаж без конзола означава повече място за кабели, DIN-релса базов профил EN-60715

Mounted without box means more space for cables, DIN-rail base shape EN-60715



ЕДИНИЧНА ЗАКРЕПВАЩА ПЛАСТИНА MA 130x65



- RT50ES
- RT50PW

- закрепваща пластина за закрепване на основа за канал MA130
върху под и/или на таван

- в съответствие с EN 50085-1

FIXING PLATE MA SINGLE 130x65

- fixing plate for fixing trunking base MA130 on the floor
and/or on the ceiling

- in accordance with EN 50085-1



- RT51ES
- RT51PW

ДВОЙНА ЗАКРЕПВАЩА ПЛАСТИНА MA 130x65

- закрепваща пластина за закрепване на две основи
за канал MA130 върху под и/или на таван

- в съответствие с EN 50085-1

FIXING PLATE MA DOUBLE 130x65

- fixing plate for fixing two trunking bases MA130 on the
floor and/or on the ceiling

- in accordance with EN 50085-1



СЕРВИЗНА КОЛОНА MA 130x65x500



- RT52ES
- RT52PW

- сервисна колона MA

- височина 500 mm

- включена в доставката монтажна рамка 7M

- в съответствие с EN 50085-1

SERVICE POST MA 130x65x500

- service post MA

- height 500mm

- mounting frame 7M included

- in accordance with EN 50085-1

ДВОЙНА СЕРВИЗНА КОЛОНА MA 130x130x500



- RT53ES
- RT53PW

- двойна сервисна колона MA

- височина 500 mm

- включени в доставката монтажни рамки 7M

- в съответствие с EN 50085-1

SERVICE POST MA DOUBLE 130x130x500

- service post MA double

- height 500mm

- mounting frames 7M included

- in accordance with EN 50085-1

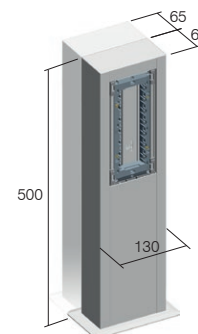

Сечение на кабел / Cable intersection mm ²	Напречно сечение на кабелите / Cable cross-section (mm ²)				
	1 проводник / 1 wire	2 проводника / 2 wires	3 проводника / 3 wires	4 проводника / 4 wires	5 проводника / 5 wires
1,5	44	111	121	144	169
2,5	49	133	157	169	211
4	58	169	183	211	256
6	68	196	225	256	307

Вместимост на канал за кабели / Trunk capacity				
Канал за кабели / Trunk	MA 130x65	MA 130x65	MA 165x65	MA 130x65
	празен / empty	с ключове и контакти Modul / with Modul switches and sockets	празен / empty	с ключове и контакти Modul / with Modul switches and sockets
вместимост / capacity max ø	7600 mm ² 54 mm	5500 mm ² 2x42 mm	9900 mm ² 54 mm	7800 mm ² 2x42 mm

П О Д О В И К О Н З О Л И М Т



RB33

разпределение

тип type	описание description	технически данни technical data
RB30	ПОДОВА КОНЗОЛА FLOOR BOX	MT 7
RB31	ПОДОВА КОНЗОЛА С ФЛАНЕЦ FLOOR BOX FLANGE	MT 7
RB33	ПОДОВА КОНЗОЛА FLOOR BOX	MT 14
⋮	⋮	⋮

	RB30	RB33	RB36	RB40	RB43	RB46
a	170	260	350	170	260	350
b	260	260	260	260	260	260
X	140	230	320	140	230	320
Y	230	230	230	230	230	230

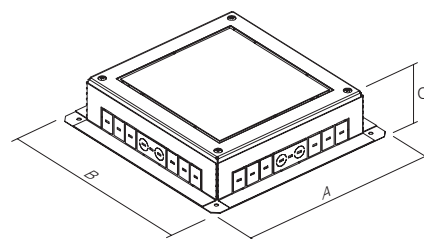
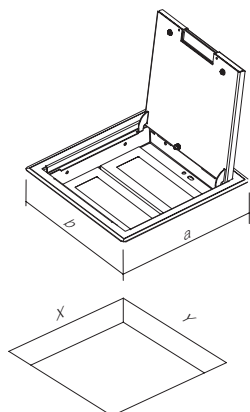

	RB31	RB34	RB37	RB41	RB44	RB47
A	250	340	430	250	340	430
B	340	340	340	340	340	340
C	95-125	95-125	95-125	125-150	125-150	125-150

ПОДОВА КОНЗОЛА MT 7



RB30

- подова конзола MT 7
- метална, сребрист цвят RAL 9006
- включена в доставката монтажна рамка MODUL 7M
- монтажни размери 140 x 230 mm, мин. дълбочина 95 mm
- дебелина на облицовката на пода до 10 mm
- в съответствие с EN 50085-1 и EN 50085-2-2

FLOOR BOX MT 7

- floor box MT 7
- metal, colour silver RAL 9006
- mounting frame MODUL 7M included
- mounting dimensions 140x230mm, depth min 95mm
- floor lining thickness up to 10mm
- in accordance with EN 50085-1 and EN 50085-2-2

ПОДОВА КОНЗОЛА MT 7 H=88 mm



RB40

- подова конзола MT 7
- метална, сребрист цвят RAL 9006
- включена в доставката монтажна рамка MODUL 7M
- монтажни размери 140 x 230 mm, мин. дълбочина 120 mm
- дебелина на облицовката на пода до 10 mm
- в съответствие с EN 50085-1 и EN 50085-2-2

FLOOR BOX MT 7 H=88mm

- floor box MT 7
- metal, colour silver RAL 9006
- mounting frame MODUL 7M included
- mounting dimensions 140x230mm, depth min 120mm
- floor lining thickness up to 10mm
- in accordance with EN 50085-1 and EN 50085-2-2

ПОДОВА КОНЗОЛА С ФЛАНЕЦ MT 7

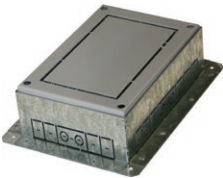

RB31

- подова конзола с фланец за капак на конзола MT 7
- метална, с галванично покритие
- за инсталиране в под или двоен под
- регулируема височина 95 -125 mm
- в съответствие с EN 50085-1 и EN 50085-2-2

FLOOR BOX FLANGE MT 7

- floor box flange for box cover MT 7
- metal, galvanized
- for installation in a floor or double floor
- adjustable height 95-125mm
- in accordance with EN 50085-1 and EN 50085-2-2

ПОДОВА КОНЗОЛА С ФЛАНЕЦ MT 7 H=88 mm

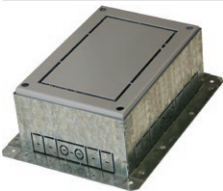

RB41

- подова конзола с фланец за капак на конзола MT 7 H=88 mm
- метална, с галванично покритие
- за инсталиране в под или двоен под
- регулируема височина 125 -150 mm
- в съответствие с EN 50085-1 и EN 50085-2-2

FLOOR BOX FLANGE MT 7 H=88mm

- floor box flange for box cover MT 7 H=88mm
- metal, galvanized
- for installation in a floor or double floor
- adjustable height 125-150mm
- in accordance with EN 50085-1 and EN 50085-2-2

ПОДОВА КОНЗОЛА MT 14



RB33

- подова конзола MT 14
- метална, сребрист цвят RAL 9006
- включена в доставката монтажна рамка MODUL 2x7M
- монтажни размери 230x230 mm, мин. дълбочина 95 mm
- дебелина на облицовката на пода до 10 mm
- в съответствие с EN 50085-1 и EN 50085-2-2

FLOOR BOX MT 14

- floor box MT 14
- metal, colour silver RAL 9006
- mounting frame MODUL 2x7M included
- mounting dimensions 230x230mm, depth min 95mm
- floor lining thickness up to 10mm
- in accordance with EN 50085-1 and EN 50085-2-2

ПОДОВА КОНЗОЛА MT 14 H=88 mm



RB43

- подова конзола MT 14
- метална, сребрист цвят RAL 9006
- включена в доставката монтажна рамка MODUL 2x7M
- монтажни размери 230x230 mm, мин. дълбочина 120 mm
- дебелина на облицовката на пода до 10 mm
- в съответствие с EN 50085-1 и EN 50085-2-2

FLOOR BOX MT 14 H=88mm

- floor box MT 14
- metal, colour silver RAL 9006
- mounting frames MODUL 2x7M included
- mounting dimensions 230x230mm, depth min 120mm
- floor lining thickness up to 10mm
- in accordance with EN 50085-1 and EN 50085-2-2

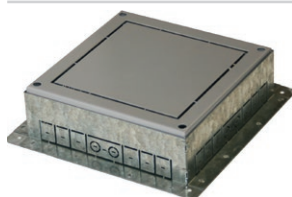

RB34

ПОДОВА КОНЗОЛА С ФЛАНЕЦ МТ 14

- подова конзола с фланец за капак на конзола МТ 14
- метална, с галванично покритие
- за инсталиране в под или двоен под
- регулируема височина 95 -125 mm
- в съответствие с EN 50085-1 и EN 50085-2-2

FLOOR BOX FLANGE MT 14

- floor box flange for box cover MT 14
- metal, galvanized
- for installation in a floor or double floor
- adjustable height 95-125mm
- in accordance with EN 50085-1 and EN 50085-2-2

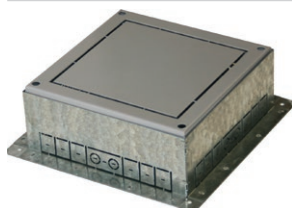

RB44

ПОДОВА КОНЗОЛА С ФЛАНЕЦ МТ 14 H=88 mm

- подова конзола с фланец за капак на конзола МТ 14 H=88 mm
- метална, с галванично покритие
- за инсталиране в под или двоен под
- регулируема височина 125 -150 mm
- в съответствие с EN 50085-1 и EN 50085-2-2

FLOOR BOX FLANGE MT 14 H=88mm

- floor box flange for box cover MT 14 H=88mm
- metal, galvanized
- for installation in a floor or double floor
- adjustable height 125-150mm
- in accordance with EN 50085-1 and EN 50085-2-2



RB36

ПОДОВА КОНЗОЛА МТ 21

- подова конзола МТ 21
- метална, сребрист цвят RAL 9006
- включена в доставката монтажни рамки MODUL 3x7M
- монтажни размери 320x230 mm, мин. дълбочина 95 mm
- дебелина на облицовката на пода до 10 mm
- в съответствие с EN 50085-1 и EN 50085-2-2

FLOOR BOX MT 21

- floor box MT 21
- metal, colour silver RAL 9006
- mounting frames MODUL 3x7M included
- mounting dimensions 320x230mm, depth min 95mm
- floor lining thickness up to 10mm
- in accordance with EN 50085-1 and EN 50085-2-2



RB46

ПОДОВА КОНЗОЛА МТ 21 H=88 mm

- подова конзола МТ 21
- метална, сребрист цвят RAL 9006
- включена в доставката монтажни рамки MODUL 3x7M
- монтажни размери 320x230 mm, мин. дълбочина 120mm
- дебелина на облицовката на пода до 10 mm
- в съответствие с EN 50085-1 и EN 50085-2-2

FLOOR BOX MT 21 H=88mm

- floor box MT 21
- metal, colour silver RAL 9006
- mounting frames MODUL 3x7M included
- mounting dimensions 320x230mm, depth min 120mm
- floor lining thickness up to 10mm
- in accordance with EN 50085-1 and EN 50085-2-2

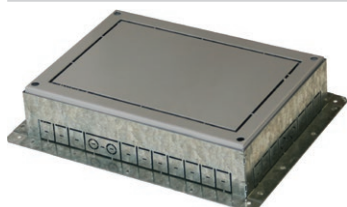

RB37

ПОДОВА КОНЗОЛА С ФЛАНЕЦ МТ 21

- подова конзола с фланец за капак на конзола МТ 21
- метална, с галванично покритие
- за инсталиране в под или двоен под
- регулируема височина 95 -125 mm
- в съответствие с EN 50085-1 и EN 50085-2-2

FLOOR BOX FLANGE MT 21

- floor box flange for box cover MT 21
- metal, galvanized
- for installation in a floor or double floor
- adjustable height 95-125mm
- in accordance with EN 50085-1 and EN 50085-2-2



RB47

ПОДОВА КОНЗОЛА С ФЛАНЕЦ МТ 21 H=88 mm

- подова конзола с фланец за капак на конзола МТ 21 H=88 mm
- метална, с галванично покритие
- за инсталиране в под или двоен под
- регулируема височина 125 -150 mm
- в съответствие с EN 50085-1 и EN 50085-2-2

FLOOR BOX FLANGE MT 21 H=88mm

- floor box flange for box cover MT 21 H=88mm
- metal, galvanized
- for installation in a floor or double floor
- adjustable height 125-150mm
- in accordance with EN 50085-1 and EN 50085-2-2

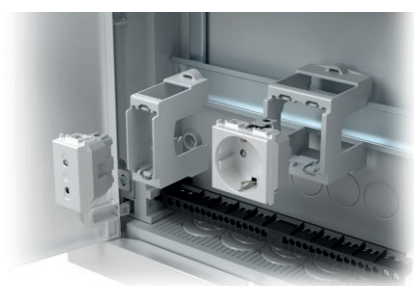

RB20

тип type	описание description	технически данни technical data
RB10	АДАПТЕР ЗА DIN РЕЛСА ADAPTER FOR DIN RAIL	35mm 1M
RB11	АДАПТЕР ЗА DIN РЕЛСА ADAPTER FOR DIN RAIL	35mm 2M
RB20	РАЗПРЕДЕЛИТЕЛНА КУТИЯ DISTRIBUTION BOX	МО 12+2
⋮	⋮	⋮

АДАПТЕР ЗА DIN РЕЛСА 35 mm 1M



RB10

- адаптер MODUL 1M
- за DIN релса 35 mm
- в съответствие с EN 50022

ADAPTER FOR DIN RAIL 35mm 1M

- adapter MODUL 1M
- for DIN rail 35mm
- in accordance with EN 50022

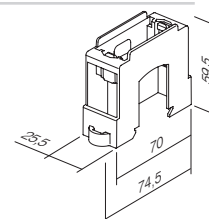

АДАПТЕР ЗА DIN РЕЛСА 35 mm 2M



RB11

- адаптер MODUL 2M
- за DIN релса 35 mm
- в съответствие с EN 50022

ADAPTER FOR DIN RAIL 35mm 2M

- adapter MODUL 2M
- for DIN rail 35mm
- in accordance with EN 50022

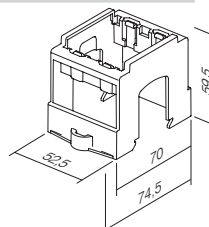

РАЗПРЕДЕЛИТЕЛНА КУТИЯ МО 12+2



RB20

- разпределителна кутия МО единичен ред 12+2MU
- 400 V[~] - клас II, IP40
- метална рамка за нивелиране и вратичка, бял цвят RAL 9016
- включени в доставката изводи за проводниците за нулата и заземяването
- за монтаж върху тухлена стена
- в съответствие с EN 60670-1 и IEC 60670-24

DISTRIBUTION BOX MO 12+2

- distribution box MO single row 12+2MU
- 400V[~], Class II, IP40
- metal leveling frame and door, colour white RAL 9016
- neutral and earth conductor terminals enclosed
- for brick wall mounting
- in accordance with EN 60670-1 and IEC 60670-24

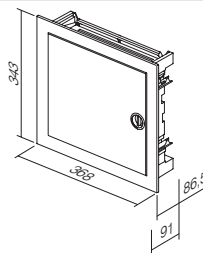

RB20V0

- за монтаж върху куха стена
- for hollow wall mounting

РАЗПРЕДЕЛИТЕЛНА КУТИЯ МО 24+4



RB21

- разпределителна кутия МО двоен ред 24+4MU
- 400 V[~] - клас II, IP40
- метална рамка за нивелиране и вратичка, бял цвят RAL 9016
- включени в доставката изводи за проводниците за нулата и заземяването
- за монтаж върху тухлена стена
- в съответствие с EN 60670-1 и IEC 60670-24

DISTRIBUTION BOX MO 24+4

- distribution box MO double row 24+4MU
- 400V[~], Class II, IP40
- metal leveling frame and door, colour white RAL 9016
- neutral and earth conductor terminals enclosed
- for brick wall mounting
- in accordance with EN 60670-1 and IEC 60670-24

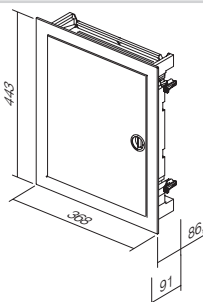

RB21V0

- за монтаж върху куха стена
- for hollow wall mounting

РАЗПРЕДЕЛИТЕЛНА КУТИЯ МО 36+6



RB22

- разпределителна кутия МО троен ред 36+6 MU
- 400 V[~] - клас II, IP40
- метална рамка за нивелиране и вратичка, бял цвят RAL 9016
- включени в доставката изводи за проводниците за нулата и заземяването
- за монтаж върху тухлена стена
- в съответствие с EN 60670-1 и IEC 60670-24

DISTRIBUTION BOX MO 36+6

- distribution box MO triple row 36+6 MU
- 400V[~], Class II, IP40
- metal leveling frame and door, colour white RAL 9016
- neutral and earth conductor terminals enclosed
- for brick wall mounting
- in accordance with EN 60670-1 and IEC 60670-24

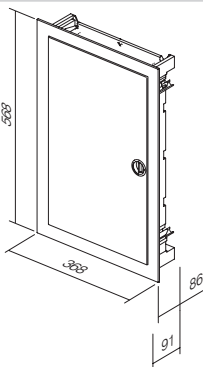

RB22V0

- за монтаж върху куха стена
- for hollow wall mounting

РАЗПРЕДЕЛИТЕЛНА КУТИЯ МО 48+8



RB23

- разпределителна кутия МО четворен ред 48+8 MU
- 400 V[~] - клас II, IP40
- метална рамка за нивелиране и вратичка, бял цвят RAL 9016
- включени в доставката изводи за проводниците за нулата и заземяването
- за монтаж върху тухлена стена
- в съответствие с EN 60670-1 и IEC 60670-24

DISTRIBUTION BOX MO 48+8

- distribution box MO quad row 48+8 MU
- 400V[~], Class II, IP40
- metal leveling frame and door, colour white RAL 9016
- neutral and earth conductor terminals enclosed
- for brick wall mounting
- in accordance with EN 60670-1 and IEC 60670-24

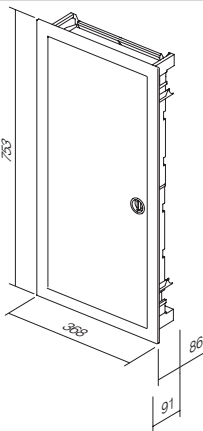

RB23V0

- за монтаж върху куха стена
- for hollow wall mounting

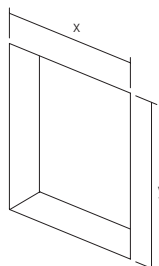

	RB20 RB20V0	RB21 RB21V0	RB22 RB22V0	RB23 RB23V0
x	314	314	314	314
y	314	414	539	724



ekonomik[®]



Planned for excellence
Style is essential



ERGO

METAL

SOFT

Неутрален, компактен, елегантен стил, който се вписва във всяка работна или жилищна зона. В интериора нищо не се набива в очи, а по-скоро хармонично му пасва.

A neutral, compact, elegant design is adjustable to every working or living area. It does not stick out from the interior, but rather harmonically fits into it.





Планирани за постигане на съвършенство Стилът е важен



Чистата линия е леко извита – добре обмислено ергономично решение специално за вас.

A pure line is slightly curved - well considered ergonomics especially for you.



Можете да изберете между лъскави отразяващи повърхности и модерно изглеждащ метал.

You can choose between shiny reflective surfaces and modern metallic look.



Мекотата на формата ще намери място както в модерния, така и в класическия интериор.

The softness of the form will find its place in modern as well as in classic interiors.

HARMONY

REFLEX

UV PROTECT

Желанията могат да бъдат най-различни. Затова ние внимателно сме подбрали възможности за вас, които може да ви предоставят правилния отговор. Неутрална палитра от цветове само ще допълни вашата околна среда – тя няма да я ограничава.

Desires can be very different. Therefore we have carefully selected possibilities for you, which can offer you the right answer. A neutral palette of colours will only complement your ambient - it will not restrict it.

Press and the world will spring to life
Colourful landscape between walls



Блестящите бели полимерни материали и оттенъците на бежовия цвят навяват настроение за размисления.

Shiny polymer materials in white and beige colours enable reflective mood.



Подбраното декоративно метално покритие е едновременно модерно и неутрално.

Selected decorative metallic coat is at the same time modern and neutral.

С едно натискане и светът ще оживее Пълноценен пейзаж между стените



За тези, които искат да си поиграят с пастелните цветове, Ekonomik Color представлява перфектното решение.

For those who want to play with pastel colours Ekonomik Color represents a perfect solution.



Здравината и високата устойчивост против външни въздействия (ултравиолетови лъчи) се гарантират от термореактивните материали (цветова гама).

Robustness and high resistance to external effects (UV) are secured by duroplastic materials (Color line).

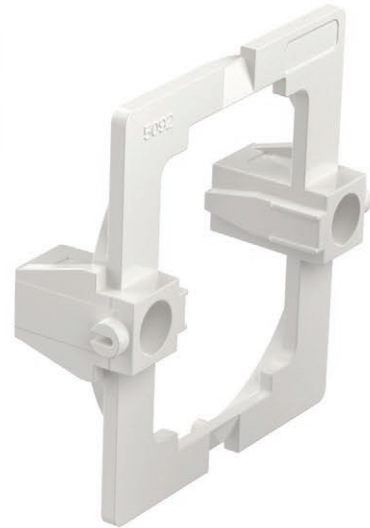
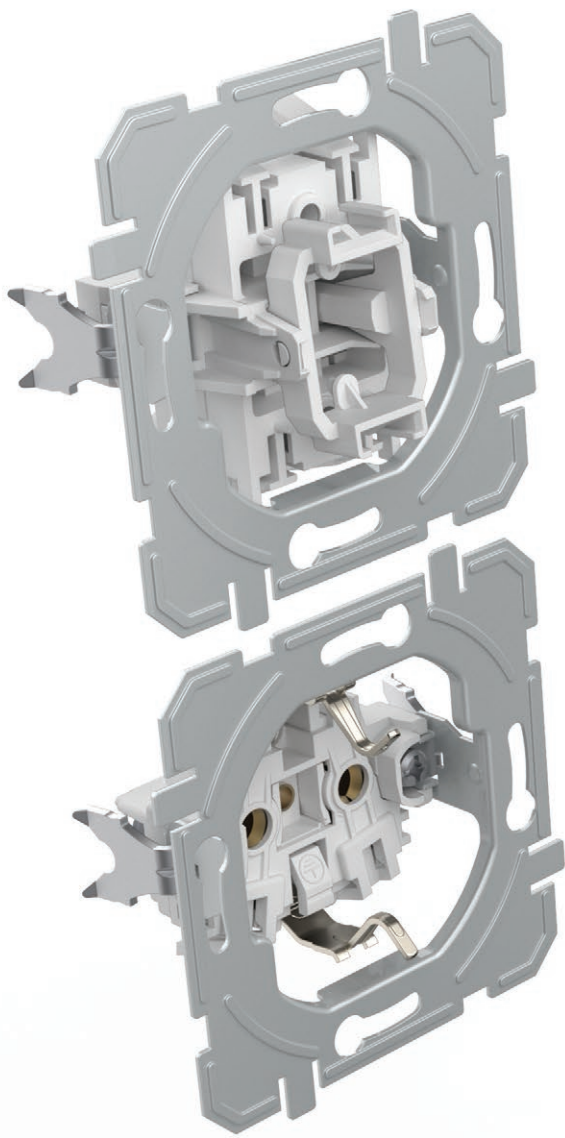

VERTICAL

HORIZONTAL

SAVE SPACE



Комбинирайки, вие икономисвате място върху стената. Когато се сблъсквате с ограничено място, »вертикално« е правилното решение.
With combining you save space on the wall. When faced with a limited space, »vertically« is the right decision.



Комбинируйте както ви се иска.
Combine as you please.



Видимите елементи могат да бъдат свалени. Бояджиите ще ви бъдат благодарни.

Visible elements can be easily taken apart. Painters will be grateful to you.



Prolonge your day with a touch
Simplified living

УДЪЛЖЕТЕ ДЕНЯ СИ С ЕДНО ДОКОСВАНЕ ПО-ЛЕСЕН ЖИВОТ

Ekonomik е решение за системата от стандартизирани кръгли инсталационни кутии. Може да се използва както за прости, така и за по-взискателни инсталации, нови сгради и приспособления. Системата се характеризира с контакти, осъществявани чрез вкарване на проводниците, което спестява време при монтажа на елементите.

Ekonomik is a solution for the system of standardized round installations boxes. It can be used for simple as well as more demanding installations, new buildings and adaptations. The system is characterised by plug-in contacts which save time during installation of elements.

Благополучие в безопасен дом

Пълно доверие във великолепната конструкция

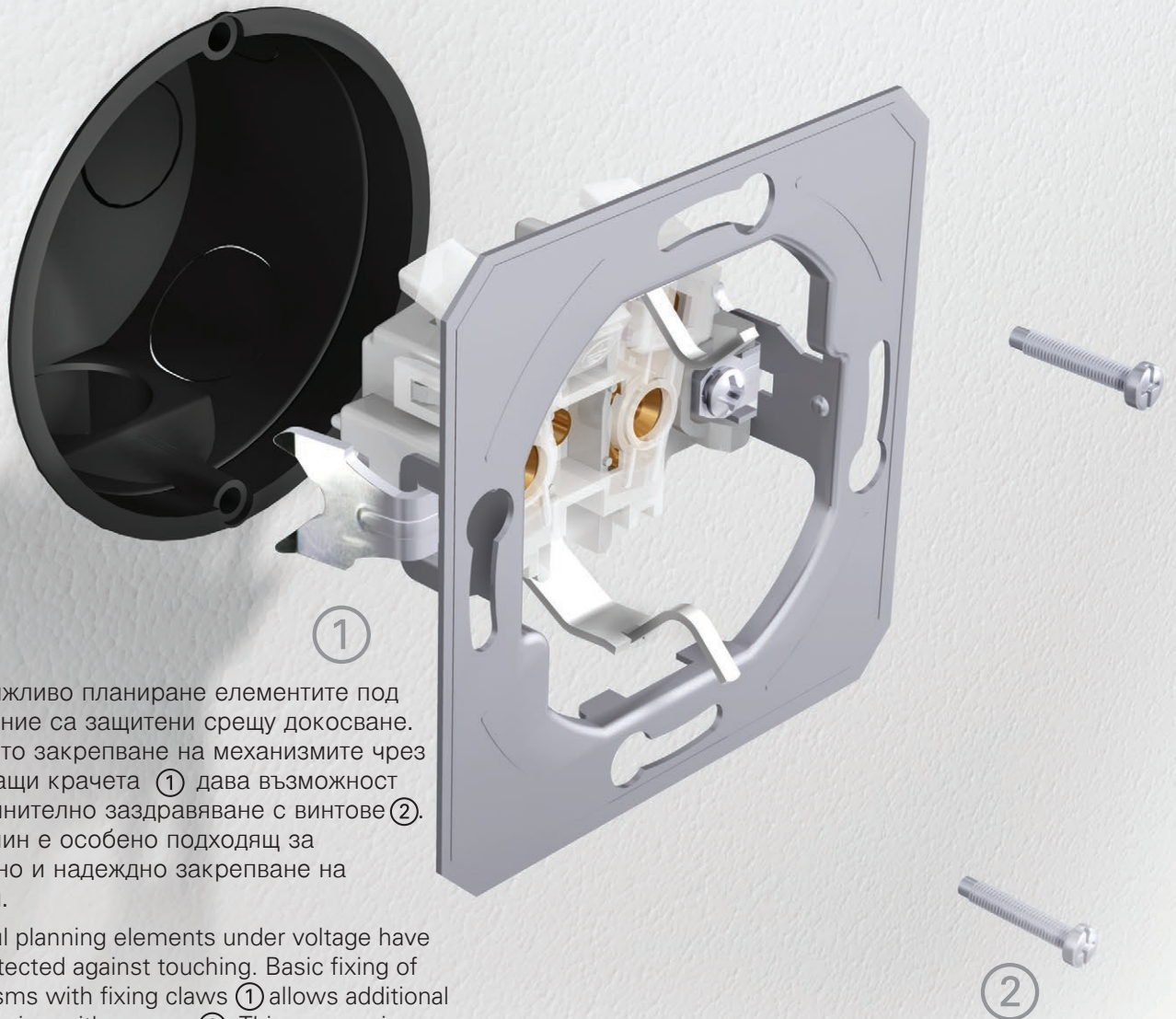

Чрез грижливо планиране елементите под напрежение са защитени срещу докосване. Основното закрепване на механизмите чрез закрепващи крачета ① дава възможност за допълнително заздравяване с винтове ②. Този начин е особено подходящ за безопасно и надеждно закрепване на контакти.

By careful planning elements under voltage have been protected against touching. Basic fixing of mechanisms with fixing claws ① allows additional strengthening with screws ②. This manner is especially appropriate for safe and reliable fixing of sockets.

SIMPLE

FAST

FLEX

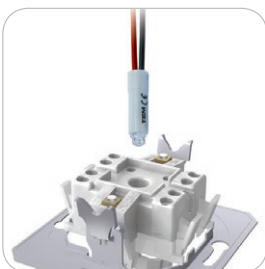

Добре планираната конструкция на ключа улеснява осветлението. A well-planned switch construction makes easy illumination possible also subsequently.



Контактите, осъществявани чрез вкарване на проводниците, позволява бързо и надеждно закрепване на проводниците. Два проводника с различни диаметри може да се свържат към един и същи контакт.

Plug-in contacts enable quick and reliable attachment of wires. Two wires of different diameters can be attached to the same contact.

Лесните за монтиране инсталационни конзоли ще улеснят работата ви. Правилните дължини са гарантирани.

Easy-fitting installation boxes will make your work easier. Proper lengths are guaranteed.



Feeling well in a safe shelter
Total confidence in a good construction

SAFE

THRUST

CERTIFIED

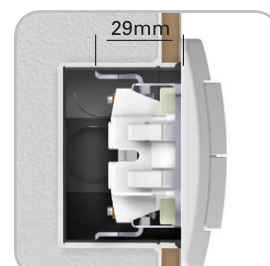

Закрепващите крачета дават възможност за по-дълбоко закрепване (също така и през керамични плочки и подобни)

Fixing claws enable deeper fixing (also through ceramic tiles, etc.)



Всички ключове имат ясно обозначения отзад.

All switches have a clear identification in the back.

Ключовете са били изпитани в съответствие с международните стандарти, което гарантира безопасност и дълъг експлоатационен живот.

Switches were tested according to international standards which guarantee safety and long life span.



Контактите, направени от сребърна сплав (Ag-Ni) гарантират безопасно включване.

Contacts made of silver alloy (Ag-Ni) guarantee safe switching.

TEM





КЛЮЧОВЕ SE <i>SWITCHES SE</i>		188
БУТОНИ TE <i>BUTTONS TE</i>		192
ОСВЕТЛЕНИЕ IA <i>ILLUMINATION IA</i>		193
КОНТАКТИ VE <i>SOCKETS VE</i>		195
КОМУНИКАЦИИ KE <i>COMMUNICATIONS KE</i>		199
КАПАЦИ PE <i>COVERS PE</i>		202
ЕЛЕКТРОНИКА EE <i>ELECTRONICS EE</i>		205
ПРИНАДЛЕЖНОСТИ AE <i>ACCESSORIES AE</i>		211
КАПАЦИ OE <i>SURROUNDS OE</i>		213

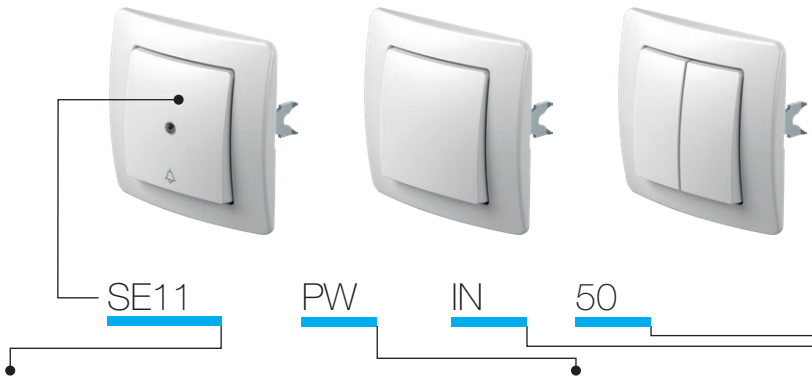

тип type	описание description	технически данни technical data	цвет colour	допълнителна информация 1 optional data 1	допълнителна информация 2 optional data 2
SE10	КЛЮЧ 1WAY SWITCH 1WAY	10AX 250V~	<input type="checkbox"/> PW снежнобял polar white	NT неутрален neutral	50
SE11	БУТОН 1WAY PUSH BUTTON 1WAY	10A 250V~	<input type="checkbox"/> IW слонова кост ivory white	IN индикатор indicator	51
SE22	КЛЮЧ 2POLE SWITCH 2POLE	16AX 250V~	<input type="checkbox"/> ES сребрист elox silver <input type="checkbox"/> CO бял с термоактивен материал white thermoset		03 04
...	<input type="checkbox"/> NB тъмночерен night black		...

КЛЮЧ 1WAY 10AX 250V~

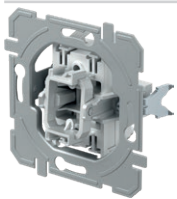

SE10

- 10AX 250V~, тип SE10
- в съответствие с EN 60669-1
- контакти чрез вкарване 1,5 - 2,5 mm²



- SWITCH 1WAY 10AX 250V~
- 10AX 250V~, type SE10
 - in accordance with EN 60669-1
 - plug-in contacts 1.5-2.5mm²

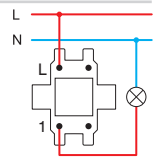

БУТОН 1WAY 10A 250V~

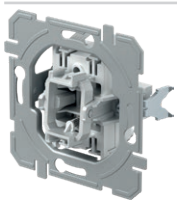

SE11

- 10A 250V~, тип SE11
- в съответствие с EN 60669-1
- контакти чрез вкарване 1,5 - 2,5 mm²



- PUSH BUTTON 1WAY 10A 250V~
- 10A 250V~, type SE11
 - in accordance with EN 60669-1
 - plug-in contacts 1.5-2.5mm²

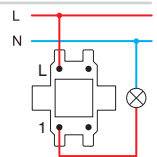

КЛЮЧ 2POLE 16AX 250V~

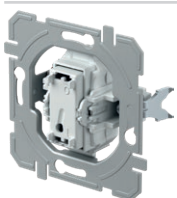

SE22

- 16AX 250V~, тип SE22
- в съответствие с EN 60669-1
- винтови контакти 1,5 - 2,5 mm²
- само в комбинация с бутон TE10__NT03

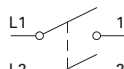

- SWITCH 2POLE 16AX 250V~
- 16AX 250V~, type SE22
 - in accordance with EN 60669-1
 - screw contacts 1.5-2.5mm²
 - only in combination with button TE10__NT03

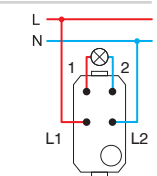

КЛЮЧ 2GANG-1WAY 10AX 250V~

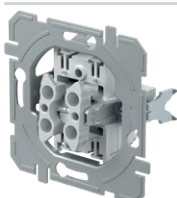

SE50

- 10AX 250V~, тип SE50
- в съответствие с EN 60669-1
- контакти чрез вкарване 1,5 - 2,5 mm²



- SWITCH 2GANG-1WAY 10AX 250V~
- 10AX 250V~, type SE50
 - in accordance with EN 60669-1
 - plug-in contacts 1.5-2.5mm²

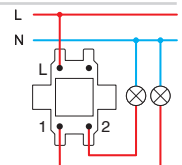

БУТОН 2GANG-1WAY 10A 250V~

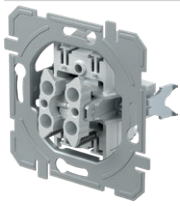

SE51

- 10 A 250 V~, тип SE51
- в съответствие с EN 60669-1
- контакти чрез вкарване 1,5 - 2,5 mm²

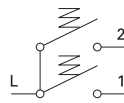

PUSH BUTTON 2GANG-1WAY 10A 250V~

- 10A 250V~, type SE51
- in accordance with EN 60669-1
- plug-in contacts 1.5-2.5mm²

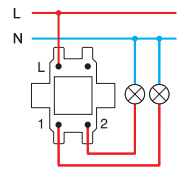

КЛЮЧ ЗА ЩОРИ 10AX 250V~

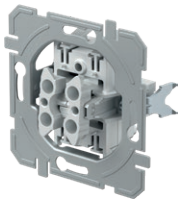

SE52

- 10AX 250 V~, тип SE52
- в съответствие с EN 60669-1
- контакти чрез вкарване 1,5 - 2,5 mm²
- с механична блокировка

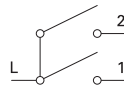

SWITCH SHUTTERS 10AX 250V~

- 10AX 250V~, type SE52
- in accordance with EN 60669-1
- plug-in contacts 1.5-2.5mm²
- with mechanical interblock

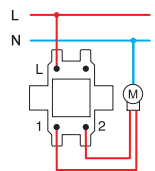

БУТОН ЗА ЩОРИ 10A 250V~

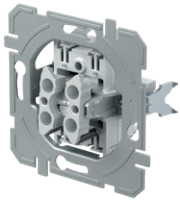

SE53

- 10A 250V~, тип SE53
- в съответствие с EN 60669-1
- контакти чрез вкарване 1,5 - 2,5 mm²
- с механична блокировка

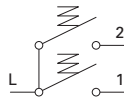

PUSH BUTTON SHUTTERS 10A 250V~

- 10A 250V~, type SE53
- in accordance with EN 60669-1
- plug-in contacts 1.5-2.5mm²
- with mechanical interblock

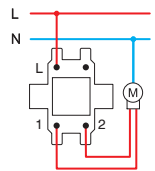

КЛЮЧ 2WAY 10AX 250V~

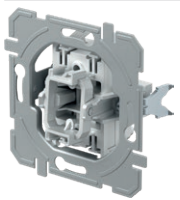

SE60

- 10AX 250V~, тип SE60
- в съответствие с EN 60669-1
- контакти чрез вкарване 1,5 - 2,5 mm²

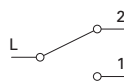

SWITCH 2WAY 10AX 250V~

- 10AX 250V~, type SE60
- in accordance with EN 60669-1
- plug-in contacts 1.5-2.5mm²

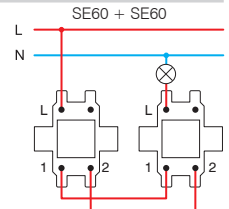

ДВОЕН КЛЮЧ 2WAY 10AX 250V~

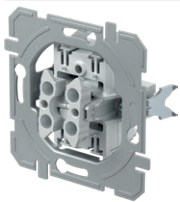

SE63

- 10AX 250V~, тип SE63
- в съответствие с EN 60669-1
- контакти чрез вкарване 1,5 - 2,5 mm²



SWITCH DOUBLE 2WAY 10AX 250V~

- 10AX 250V~, type SE63
- in accordance with EN 60669-1
- plug-in contacts 1.5-2.5mm²

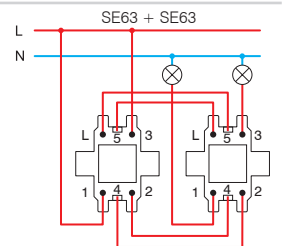

КРЪСТАТ КЛЮЧ 10AX 250V~

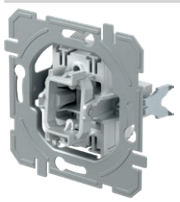

SE70

- 10AX 250V~, тип SE70
- в съответствие с EN 60669-1
- контакти чрез вкарване 1,5 - 2,5 mm²



SWITCH INTERMEDIATE 10AX 250V~

- 10AX 250V~, type SE70
- in accordance with EN 60669-1
- plug-in contacts 1.5-2.5mm²

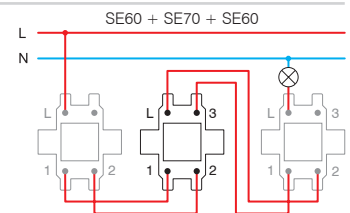



- SE10PW
- SE10IW
- SE10ES
- SE10CO
- SE10NB

КЛЮЧ 1WAY 10AX 250V~

- 10AX 250V~, тип SE10
- в съответствие с EN 60669-1
- контакти чрез вкарване 1,5 - 2,5 mm²

SWITCH 1WAY 10AX 250V~

- 10AX 250V~, type SE10
- in accordance with EN 60669-1
- plug-in contacts 1.5-2.5mm²



- SE10PWIN
- SE10IWIN
- SE10ESIN
- SE10COIN
- SE10NBIN

КЛЮЧ 1WAY 10AX 250V~ __ IN

- IN индикатор
- 10AX 250V~, тип SE10
- в съответствие с EN 60669-1
- контакти чрез вкарване 1,5 - 2,5 mm²

SWITCH 1WAY 10AX 250V~ __ IN

- IN indicator
- 10AX 250V~, type SE10
- in accordance with EN 60669-1
- plug-in contacts 1.5-2.5mm²



- SE11PW
- SE11IW
- SE11ES
- SE11CO
- SE11NB

БУТОН 1WAY 10A 250V~

- 10A 250V~, тип SE11
- в съответствие с EN 60669-1
- контакти чрез вкарване 1,5 - 2,5 mm²

PUSH BUTTON 1WAY 10A 250V~

- 10A 250V~, type SE11
- in accordance with EN 60669-1
- plug-in contacts 1.5-2.5mm²



- SE11PWTI50
- SE11IWTI50
- SE11ESTI50
- SE11COTI50
- SE11NBTI50

БУТОН 1WAY 10A 250V~ __ TI 50

- TI 50 звънчев индикатор+неонова лампа
- 10A 250V~, тип SE11
- в съответствие с EN 60669-1
- контакти чрез вкарване 1,5 - 2,5 mm²

PUSH BUTTON 1WAY 10A 250V~ __ TI 50

- TI 50 indicator bell+neon lamp
- 10A 250V~, type SE11
- in accordance with EN 60669-1
- plug-in contacts 1.5-2.5mm²



- SE11PWTI51
- SE11IWTI51
- SE11ESTI51
- SE11COTI51
- SE11NBTI51

БУТОН 1WAY 10A 250V~ __ TI 51

- TI 51 светлинен индикатор+неонова лампа
- 10A 250V~, тип SE11
- в съответствие с EN 60669-1
- контакти чрез вкарване 1,5 - 2,5 mm²

PUSH BUTTON 1WAY 10A 250V~ __ TI 51

- TI 51 indicator light+neon lamp
- 10A 250V~, type SE11
- in accordance with EN 60669-1
- plug-in contacts 1.5-2.5mm²



- SE11PWIL
- SE11IWIL
- SE11ESIL
- SE11COIL
- SE11NBIL

БУТОН 1WAY 10A 250V~ __ IL

- IL панел с надпис
- 10A 250V~, тип SE11
- в съответствие с EN 60669-1
- контакти чрез вкарване 1,5 - 2,5 mm²

PUSH BUTTON 1WAY 10A 250V~ __ IL

- IL inscription plate
- 10A 250V~, type SE11
- in accordance with EN 60669-1
- plug-in contacts 1.5-2.5mm²



- SE22PWIN03
- SE22IWIN03
- SE22ESIN03
- SE22NBIN03

КЛЮЧ 2POLE 16AX 250V~ __ IN 03

- IN 03 неутрално положение 0-1
- 16AX 250V~, тип SE22
- в съответствие с EN 60669-1
- винтови контакти 1,5 - 2,5 mm²

SWITCH 2POLE 16AX 250V~ __ IN 03

- IN 03 neutral 0-1
- 16AX 250V~, type SE22
- in accordance with EN 60669-1
- screw contacts 1.5-2.5mm²



	<ul style="list-style-type: none"> <input type="checkbox"/> SE50PW <input type="checkbox"/> SE50IW <input type="checkbox"/> SE50ES <input type="checkbox"/> SE50CO <input type="checkbox"/> SE50NB 	<p>КЛЮЧ 2GANG-1WAY 10AX 250V~</p> <ul style="list-style-type: none"> - 10AX 250V~, тип SE50 - в съответствие с EN 60669-1 - контакти чрез вкарване 1,5 - 2,5 mm² <p><i>SWITCH 2GANG-1WAY 10AX 250V~</i></p> <ul style="list-style-type: none"> - 10AX 250V~, type SE50 - in accordance with EN 60669-1 - plug-in contacts 1.5-2.5mm² 	
	<ul style="list-style-type: none"> <input type="checkbox"/> SE51PW <input type="checkbox"/> SE51IW <input type="checkbox"/> SE51ES <input type="checkbox"/> SE51CO <input type="checkbox"/> SE51NB 	<p>БУТОН 2GANG-1WAY 10A 250V~</p> <ul style="list-style-type: none"> - 10 A 250 V~, тип SE51 - в съответствие с EN 60669-1 - контакти чрез вкарване 1,5 - 2,5 mm² <p><i>PUSH BUTTON 2GANG-1WAY 10A 250V~</i></p> <ul style="list-style-type: none"> - 10A 250V~, type SE51 - in accordance with EN 60669-1 - plug-in contacts 1.5-2.5mm² 	
	<ul style="list-style-type: none"> <input type="checkbox"/> SE52PWNT09 <input type="checkbox"/> SE52IWNT09 <input type="checkbox"/> SE52ESNT09 <input type="checkbox"/> SE52CONT09 <input type="checkbox"/> SE52NBNT09 	<p>КЛЮЧ ЗА ЩОРИ 10AX 250V~ __ NT 09</p> <ul style="list-style-type: none"> - NT 09 неутрално положение – нагоре-надолу - 10AX 250 V~, тип SE52 - в съответствие с EN 60669-1 - контакти чрез вкарване 1,5 - 2,5 mm² - с механична блокировка <p><i>SWITCH SHUTTERS 10AX 250V~ __ NT 09</i></p> <ul style="list-style-type: none"> - NT 09 neutral up-down - 10AX 250V~, type SE52 - in accordance with EN 60669-1 - plug-in contacts 1.5-2.5mm² - with mechanical interblock 	
	<ul style="list-style-type: none"> <input type="checkbox"/> SE53PWNT09 <input type="checkbox"/> SE53IWNT09 <input type="checkbox"/> SE53ESNT09 <input type="checkbox"/> SE53CONT09 <input type="checkbox"/> SE53NBNT09 	<p>БУТОНИ ЗА ЩОРИ 10A 250V~ __ NT 09</p> <ul style="list-style-type: none"> - NT 09 неутрално положение – нагоре-надолу - 10 A 250 V~, тип SE53 - в съответствие с EN 60669-1 - контакти чрез вкарване 1,5 - 2,5 mm² - с механична блокировка <p><i>PUSH BUTTON SHUTTERS 10A 250V~ __ NT 09</i></p> <ul style="list-style-type: none"> - NT 09 neutral up-down - 10A 250V~, type SE53 - in accordance with EN 60669-1 - plug-in contacts 1.5-2.5mm² - with mechanical interblock 	
	<ul style="list-style-type: none"> <input type="checkbox"/> SE60PW <input type="checkbox"/> SE60IW <input type="checkbox"/> SE60ES <input type="checkbox"/> SE60CO <input type="checkbox"/> SE60NB 	<p>КЛЮЧ 2WAY 10AX 250V~</p> <ul style="list-style-type: none"> - 10AX 250V~, тип SE60 - в съответствие с EN 60669-1 - контакти чрез вкарване 1,5 - 2,5 mm² <p><i>SWITCH 2WAY 10AX 250V~</i></p> <ul style="list-style-type: none"> - 10AX 250V~, type SE60 - in accordance with EN 60669-1 - plug-in contacts 1.5-2.5mm² 	
	<ul style="list-style-type: none"> <input type="checkbox"/> SE63PW <input type="checkbox"/> SE63IW <input type="checkbox"/> SE63ES <input type="checkbox"/> SE63CO <input type="checkbox"/> SE63NB 	<p>ДВОЕН КЛЮЧ 2WAY 10AX 250V~</p> <ul style="list-style-type: none"> - 10AX 250V~, тип SE63 - в съответствие с EN 60669-1 - контакти чрез вкарване 1,5 - 2,5 mm² <p><i>SWITCH DOUBLE 2WAY 10AX 250V~</i></p> <ul style="list-style-type: none"> - 10AX 250V~, type SE63 - in accordance with EN 60669-1 - plug-in contacts 1.5-2.5mm² 	
	<ul style="list-style-type: none"> <input type="checkbox"/> SE70PW <input type="checkbox"/> SE70IW <input type="checkbox"/> SE70ES <input type="checkbox"/> SE70CO <input type="checkbox"/> SE70NB 	<p>КРЪСТАТ КЛЮЧ 10AX 250V~</p> <ul style="list-style-type: none"> - 10AX 250V~, тип SE70 - в съответствие с EN 60669-1 - контакти чрез вкарване 1,5 - 2,5 mm² <p><i>SWITCH INTERMEDIATE 10AX 250V~</i></p> <ul style="list-style-type: none"> - 10AX 250V~, type SE70 - in accordance with EN 60669-1 - plug-in contacts 1.5-2.5mm² 	

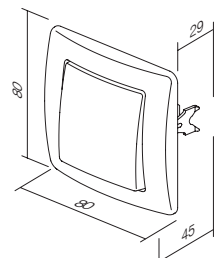
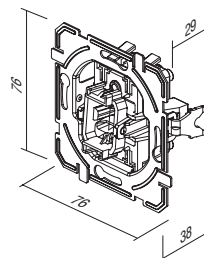

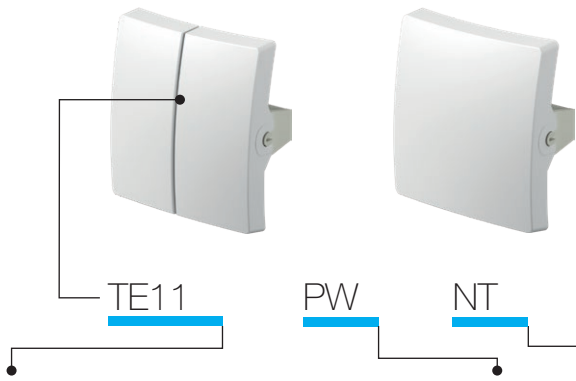

тип type	описание description	цвет colour	допълнителна информация 1 optional data 1	допълнителна информация 2 optional data 2
TE10	БУТОН 1GANG BUTTON 1GANG	<input type="checkbox"/> PW снежнобял цвят polar white	NT с неутрално положение neutral	50
TE11	БУТОН 2GANG BUTTON 2GANG	<input type="checkbox"/> IW слоновя кост ivory white	IN индикатор indicator	51
...	...	<input type="checkbox"/> ES сребрист elox silver		03
...	...	<input type="checkbox"/> CO бял с термореактивен материал white thermoset		04
...	...	<input type="checkbox"/> NB тъмночерен night black		

БУТОН 1GANG



- TE10PW
- TE10IW
- TE10ES
- TE10CO
- TE10NB

- бутон заедно с носач
BUTTON 1GANG
- button together with carrier



БУТОН С ИНДИКАТОР

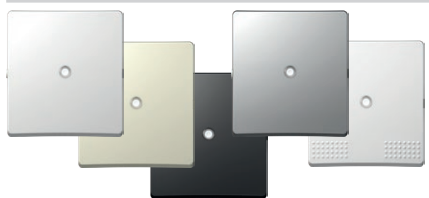

- TE10PIN
- TE10IWIN
- TE10ESIN
- TE10COIN
- TE10NBIN

- бутон заедно с носач
BUTTON INDICATOR
- button together with carrier



БУТОН С ПАНЕЛ С НАДПИС

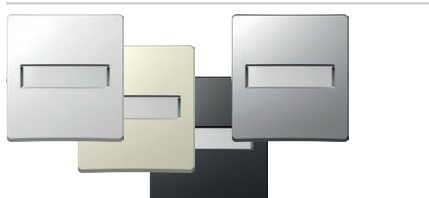

- TE13PWIL
- TE13IWIL
- TE13ESIL
- TE13NBIL

- бутон заедно с носач, с панел с надпис
BUTTON WITH INSCRIPTION PLATE
- button together with carrier, with inscription plate



БУТОН 2GANG



- TE11PW
- TE11IW
- TE11ES
- TE11CO
- TE11NB

- бутон 2gang с носач
BUTTON 2GANG
- button 2gang together with carrier

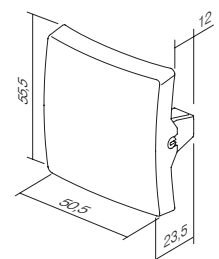
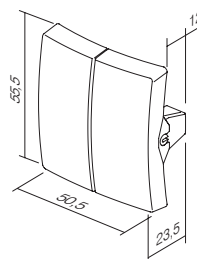

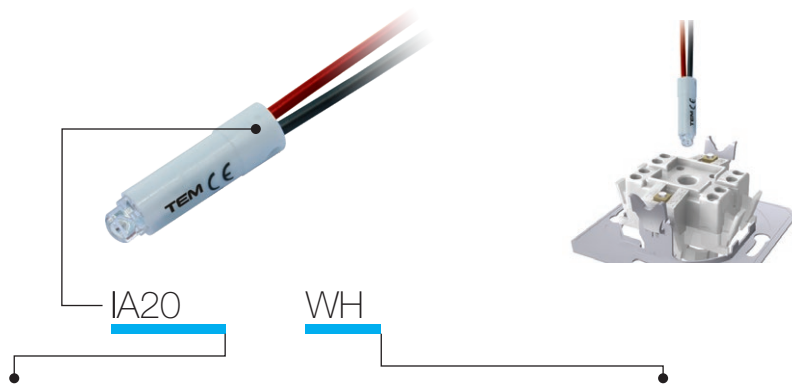

тип type	описание description	технически данни technical data	цвет colour
IA10	НЕОНОВА ЛАМПА NEON LAMP	230V~ 0,34W	<input type="checkbox"/> WH бял цвят white
IA20	СВЕТОДИОДНА ЛАМПА LED LAMP	230V~ 0,40W	<input checked="" type="checkbox"/> BL син цвят blue
IA21	СВЕТОДИОДНА ЛАМПА LED LAMP	24V AC/DC 0,20W	<input checked="" type="checkbox"/> RD червен red
·	·	·	<input checked="" type="checkbox"/> GR зелен green
·	·	·	<input checked="" type="checkbox"/> OR оранжев orange

НЕОНОВА ЛАМПА 230 V~ 0,34 W



IA10OR

- за индикация, осветление или постоянно осветяване на ключ
- в комбинация с бутон с индикатор

NEON LAMP 230V~ 0,34W

- for indication, illumination or constant illumination of switch
- in combination with button with indicator

СВЕТОДИОДНА ЛАМПА 230 V AC/DC 0,40 W



IA20WH
 IA20GR
 IA20RD
 IA20BL

- за индикация, осветление или постоянно осветяване на ключ
- в комбинация с бутон с индикатор

LED LAMP 230V AC/DC 0,40W

- for indication, illumination or constant illumination of switch
- in combination with button with indicator

СВЕТОДИОДНА ЛАМПА 24V AC/DC 0,20W

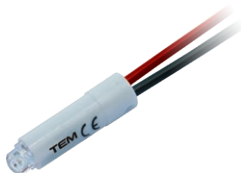

IA21WH
 IA21RD

- за индикация, осветление или постоянно осветяване на ключ
- в комбинация с бутон с индикатор

LED LAMP 24V AC/DC 0,20W

- for indication, illumination or constant illumination of switch
- in combination with button with indicator

СВЕТОДИОДНА ЛАМПА 12V AC/DC 0,10W

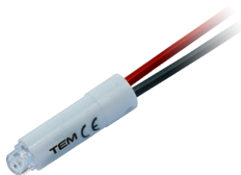

IA22WH
 IA22RD

- за индикация, осветление или постоянно осветяване на ключ
- в комбинация с бутон с индикатор

LED LAMP 12V AC/DC 0,10W

- for indication, illumination or constant illumination of switch
- in combination with button with indicator

индикация /
Indication

* освещение /
Illumination

Постоянно освещение /
Illumination always on

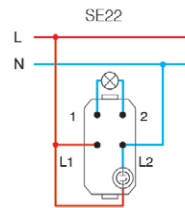
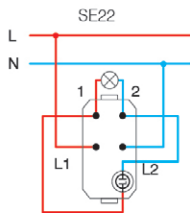
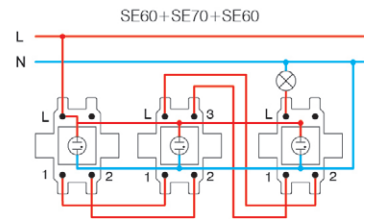
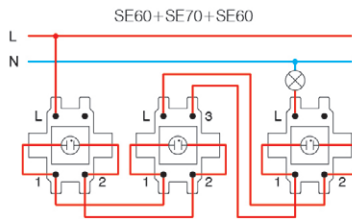
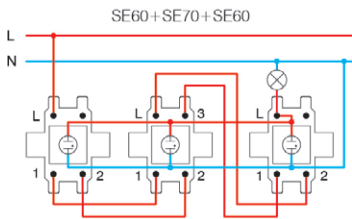
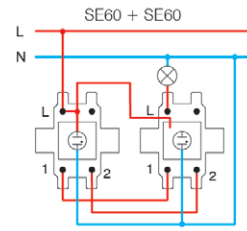
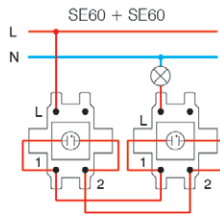
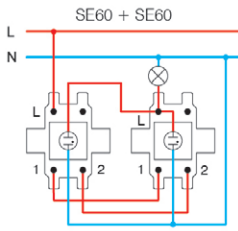
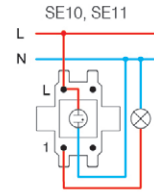
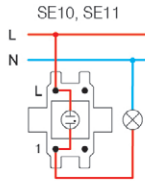
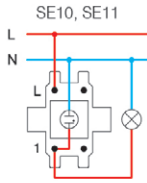

* връзките не са подходящи за енергоспестяващи крушки (CFL, LED) /
the connections are not suitable for energy-saving bulbs (CFL, LED)

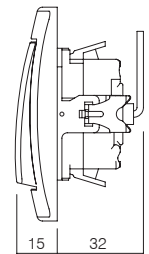

S O C K E T S V E

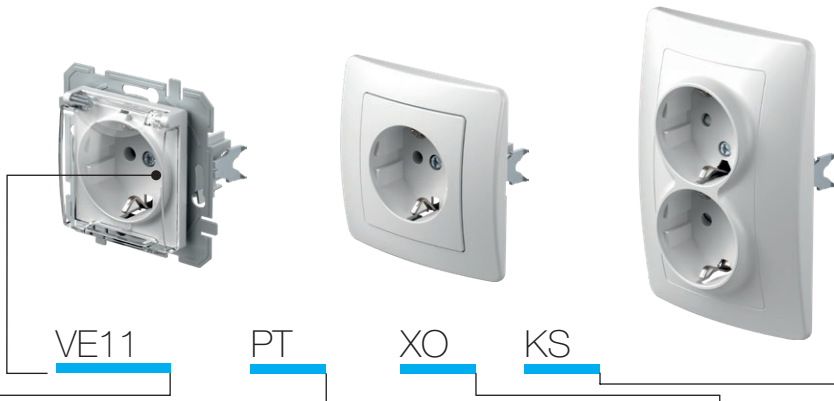

тип type	описание description	технически данни technical data	допълнителна информация 1 optional data 1	допълнителна информация 2 optional data 2
VE10	КОНТАКТ ШУКО SOCKET SCHUKO	2P+E 16A 250V~	XO без декоративен панел without cover plate	KS Вградена защита от допир на контакти shuttered live contacts
VE11	КОНТАКТ ШУКО+КАПАК SOCKET SCHUKO+COVER	2P+E 16A 250V~		
VE12	КОНТАКТ ШУКО SOCKET SCHUKO	2P+E 16A 250V~ BV	KS Вградена защита от допир на контакти shuttered live contacts	
⋮	⋮	⋮		

ЦВЯТ
colour

<input type="checkbox"/> PW снежнобял цвят polar white	<input checked="" type="checkbox"/> PT бял + прозрачен white+transparent	<input type="checkbox"/> PP бял + бял white+white
<input checked="" type="checkbox"/> IW слонова кост ivory white	<input checked="" type="checkbox"/> IT слонова кост + прозрачен ivory+transparent	<input checked="" type="checkbox"/> II слонова кост + слонова кост ivory+ivory
<input type="checkbox"/> ES сребрист elox silver	<input checked="" type="checkbox"/> ST сребрист + прозрачен silver+transparent	<input type="checkbox"/> SS сребрист + сребрист silver+silver
<input type="checkbox"/> CO бял с термореактивен материал white thermoset	<input checked="" type="checkbox"/> CT бял + прозрачен white+transparent	<input checked="" type="checkbox"/> BB черен + черен black+black
<input checked="" type="checkbox"/> NB тъмночерен night black	<input checked="" type="checkbox"/> BT черен + прозрачен black+transparent	<input checked="" type="checkbox"/> RR червен + червен red+red
<input checked="" type="checkbox"/> RD червен red	<input checked="" type="checkbox"/> RT червен + прозрачен red+transparent	<input checked="" type="checkbox"/> GG зелен + зелен green+green
<input checked="" type="checkbox"/> GR зелен green	<input checked="" type="checkbox"/> GT зелен + прозрачен green+transparent	<input checked="" type="checkbox"/> OO оранжев + оранжев orange+orange
<input checked="" type="checkbox"/> OR оранжев orange	<input checked="" type="checkbox"/> OT оранжев + прозрачен orange+transparent	



Шуко – в съответствие с EN 60884-1, CEE7 (лист със стандарти III)

schuko - in accordance with EN 60884-1, CEE7 (standard sheet III)

Френски – в съответствие с NF C 61-314 (лист със стандарти V)

French - in accordance with NF C 61-314 (standard sheet V)

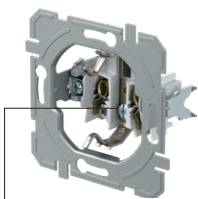

винтови контакти
screw contacts

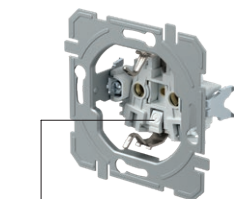

BV контакти чрез вкарване
BV plug-in contacts

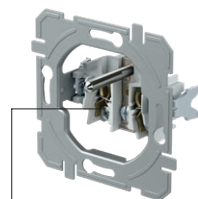

винтови контакти
screw contacts

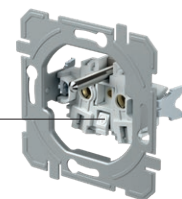

BV контакти чрез вкарване
BV plug-in contacts

КОНТАКТ ШУКО 2P+E 16A 250V~ __ XO



- VE10PWXO
- VE10IWXO
- VE10ESXO
- VE10COXO
- VE10NBXO
- VE10RDXO
- VE10GRXO
- VE10ORXO

- винтови контакти 1,5 - 2,5 mm²
- XO без панел
- 2P+E шуко
- 16A 250V~, тип VE10

SOCKET SCHUKO 2P+E 16A 250V~ __ XO

- screw contacts 1.5-2.5mm²
- XO without surround
- 2P+E schuko
- 16A 250V~, type VE10



КОНТАКТ ШУКО+КАПАК 2P+E 16A 250 V~ __ XO



- VE11PTXO
- VE11ITXO
- VE11STXO
- VE11BTXO

- винтови контакти 1,5 - 2,5 mm²
- XO без рамка
- 2P+E шуко+капак
- 16 A 250 V~, тип VE11

SOCKET SCHUKO+COVER 2P+E 16A 250V~ __ XO

- screw contacts 1.5-2.5mm²
- XO without surround
- 2P+E schuko+cover
- 16A 250V~, type VE11



КОНТАКТ ШУКО 2P+E 16A 250V~ BV __ XO



- VE12PWXO
- VE12IWXO
- VE12ESXO
- VE12COXO
- VE12NBXO
- VE12RDXO
- VE12GRXO
- VE12ORXO

- BV контакти чрез вкарване 1,5 - 2,5 mm²
- XO без панел
- 2P+E шуко
- 16A 250V~, тип VE12

SOCKET SCHUKO 2P+E 16A 250V~ BV __ XO

- BV plug-in contacts 1.5-2.5mm²
- XO without surround
- 2P+E schuko
- 16A 250V~, type VE12



КОНТАКТ ШУКО+КАПАК 2P+E 16A 250V~ BV __ XO

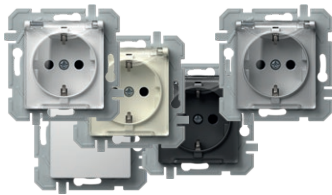

- VE13PTXO
- VE13ITXO
- VE13STXO
- VE13BTXO
- VE13PPXO

- BV контакти чрез вкарване 1,5 - 2,5 mm²
- XO без панел
- 2P+E шуко+капак
- 16A 250V~, тип VE13

SOCKET SCHUKO+COVER 2P+E 16A 250V~ BV __ XO

- BV plug-in contacts 1.5-2.5mm²
- XO without surround
- 2P+E schuko+cover
- 16A 250V~, type VE13



КОНТАКТ ШУКО 2P+E 16A 250V~



- VE10PW
- VE10IW
- VE10ES
- VE10CO
- VE10NB

- винтови контакти 1,5 - 2,5 mm²
- 2P+E шуко
- 16A 250V~, тип VE10

SOCKET SCHUKO 2P+E 16A 250V~

- screw contacts 1.5-2.5mm²
- 2P+E schuko
- 16A 250V~, type VE10



КОНТАКТ ШУКО+КАПАК 2P+E 16A 250V~



- VE11PT
- VE11IT
- VE11ST
- VE11CT
- VE11BT

- винтови контакти 1,5 - 2,5 mm²
- 2P+E шуко+капак
- 16A 250V~, тип VE11

SOCKET SCHUKO+COVER 2P+E 16A 250V~

- screw contacts 1.5-2.5mm²
- 2P+E schuko+cover
- 16A 250V~, type VE11



КОНТАКТ ШУКО 2P+E 16A 250V~ BV



- VE12PW
- VE12IW
- VE12ES
- VE12CO
- VE12NB

- BV контакти чрез вкарване 1,5 - 2,5 mm²
- 2P+E шуко
- 16A 250V~, тип VE12

SOCKET SCHUKO 2P+E 16A 250V~ BV

- BV plug-in contacts 1.5-2.5mm²
- 2P+E schuko
- 16A 250V~, type VE12



КОНТАКТ ШУКО+КАПАК 2P+E 16A 250V~ BV



- VE13PT
- VE13IT
- VE13ST
- VE13CT
- VE13BT

- BV контакти чрез вкарване 1,5 - 2,5 mm²
- 2P+E шуко+капак
- 16A 250V~, тип VE13

SOCKET SCHUKO+COVER 2P+E 16A 250V~ BV

- BV plug-in contacts 1.5-2.5mm²
- 2P+E schuko+cover
- 16A 250V~, type VE13

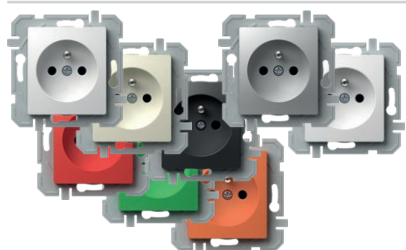

КОНТАКТ ФРЕНСКИ 2P+E 16A 250V~ __ XO

- VE40PWXO
 - VE40IWXO
 - VE40ESXO
 - VE40COXO
 - VE40NBXO
 - VE40RDXO
 - VE40GRXO
 - VE40ORXO
- винтови контакти 1,5 - 2,5 mm²
 - XO без панел
 - 2P+E френски контакт
 - 16A 250V~, тип VE40

SOCKET FRENCH 2P+E 16A 250V~ __ XO

- screw contacts 1.5-2.5mm²
- XO without surround
- 2P+E French
- 16A 250V~, type VE40

КОНТАКТ ФРЕНСКИ+КАПАК 2P+E 16A 250V~ __ XO

- VE41PTXO
 - VE41ITXO
 - VE41STXO
 - VE41PTXO
 - VE41BTXO
 - VE41PPXO
- винтови контакти 1,5 - 2,5 mm²
 - XO без панел
 - 2P+E френски контакт+капак
 - 16A 250V~, тип VE41

SOCKET FRENCH+COVER 2P+E 16A 250V~ __ XO

- screw contacts 1.5-2.5mm²
- XO without surround
- 2P+E French+cover
- 16A 250V~, type VE41

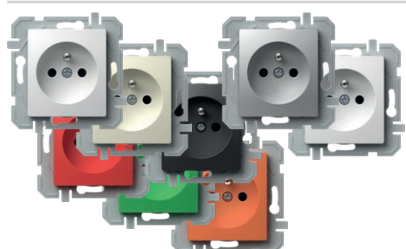
КОНТАКТ ФРЕНСКИ 2P+E 16A 250V~ BV __ XO

- VE42PWXO
 - VE42IWXO
 - VE42ESXO
 - VE42COXO
 - VE42NBXO
 - VE42RDXO
 - VE42GRXO
 - VE42ORXO
- BV контакти чрез вкарване 1,5 - 2,5 mm²
 - XO без панел
 - 2P+E френски контакт
 - 16A 250V~, тип VE42

SOCKET FRENCH 2P+E 16A 250V~ BV __ XO

- BV plug-in contacts 1.5-2.5mm²
- XO without surround
- 2P+E French
- 16A 250V~, type VE42

КОНТАКТ ФРЕНСКИ+КАПАК 2P+E 16A 250 V~ BV __ XO

- VE43PTXO
 - VE43ITXO
 - VE43STXO
 - VE43PTXO
 - VE43BTXO
 - VE43PPXO
- BV контакти чрез вкарване 1,5 - 2,5 mm²
 - XO без рамка
 - 2P+E френски контакт+капак
 - 16A 250 V~, тип VE43

SOCKET FRENCH+COVER 2P+E 16A 250V~ BV __ XO

- BV plug-in contacts 1.5-2.5mm²
- XO without surround
- 2P+E French+cover
- 16A 250V~, type VE43

КОНТАКТ ФРЕНСКИ 2P+E 16A 250V~

- VE40PW
 - VE40IW
 - VE40ES
 - VE40CO
 - VE40NB
- винтови контакти 1,5 - 2,5 mm²
 - 2P+E френски контакт
 - 16A 250V~, тип VE40

SOCKET FRENCH 2P+E 16A 250V~

- screw contacts 1.5-2.5mm²
- 2P+E French
- 16A 250V~, type VE40

КОНТАКТ ФРЕНСКИ+КАПАК 2P+E 16A 250V~

- VE41PT
 - VE41IT
 - VE41BT
 - VE41ST
- винтови контакти 1,5 - 2,5 mm²
 - 2P+E френски контакт+капак
 - 16A 250V~, тип VE41

SOCKET FRENCH+COVER 2P+E 16A 250V~

- screw contacts 1.5-2.5mm²
- 2P+E French+cover
- 16A 250V~, type VE41

КОНТАКТ ФРЕНСКИ 2P+E 16A 250V~ BV

- VE42PW
 - VE42IW
 - VE42ES
 - VE42CO
 - VE42NB
- BV контакти чрез вкарване 1,5 - 2,5 mm²
 - 2P+E френски контакт
 - 16A 250V~, тип VE42

SOCKET FRENCH 2P+E 16A 250V~ BV

- BV plug-in contacts 1.5-2.5mm²
- 2P+E French
- 16A 250V~, type VE42

КОНТАКТ ФРЕНСКИ+КАПАК 2P+E 16A 250V~ BV

- VE43PT
 - VE43IT
 - VE43BT
 - VE43ST
- BV контакти чрез вкарване 1,5 - 2,5 mm²
 - 2P+E френски контакт+капак
 - 16A 250V~, тип VE43

SOCKET FRENCH+COVER 2P+E 16A 250V~ BV

- BV plug-in contacts 1.5-2.5mm²
- 2P+E French+cover
- 16A 250V~, type VE43



КОНТАКТ ШУКО DOUBLE 2P+E 16A 250V~



- VE16PWKS
- VE16IWKS
- VE16ESKS
- VE16NBKS

- 2P+E шуко двоен, 16A 250V~, тип VE16
- в съответствие с IEC 60884-1, CEE7
- винтови контакти 1,5 - 2,5 mm²
- KS защита от допир на контакти

SOCKET SCHUKO DOUBLE 2P+E 16A 250V~

- 2P+E schuko double
- 16A 250V~, type VE16
- in accordance with IEC 60884-1, CEE7
- screw contacts 1.5-2.5 mm²
- KS shuttered live contacts



КОНТАКТ ФРЕНСКИ ДВОЕН 2P+E 16A 250V~



- VE46PWKS
- VE46IWKS
- VE46ESKS
- VE46NBKS

- 2P+E френски двоен, 16A 250V~, тип VE46
- в съответствие с IEC 60884-1, CEE7; NF C 61-314, CSN 33 2318; PN-E 93201
- винтови контакти 1,5 - 2,5 mm²
- KS защита от допир на контакти

SOCKET FRENCH DOUBLE 2P+E 16A 250V~

- 2P+E French double
- 16A 250V~, type VE46
- in accordance with IEC 60884-1, CEE7; NF C 61-314, CSN 33 2318; PN-E 93201
- screw contacts 1.5-2.5 mm²
- KS shuttered live contacts



КОНТАКТ 2P 16A 250V~

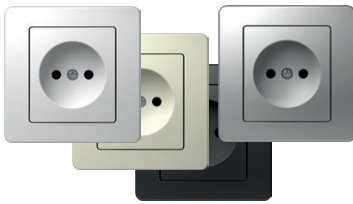

- VE30PW
- VE30IW
- VE30ES
- VE30NB

- 2P без контакт за заземяване
- 16A 250V~
- в съответствие с EN 60884-1, CEE7 (лист със стандарти I)
- винтови контакти 1,5 - 2,5 mm²

SOCKET 2P 16A 250V~

- 2P without earthing contact
- 16A 250V~
- in accordance with EN 60884-1, CEE7 (standard sheet I)
- screw contacts 1.5-2.5mm²

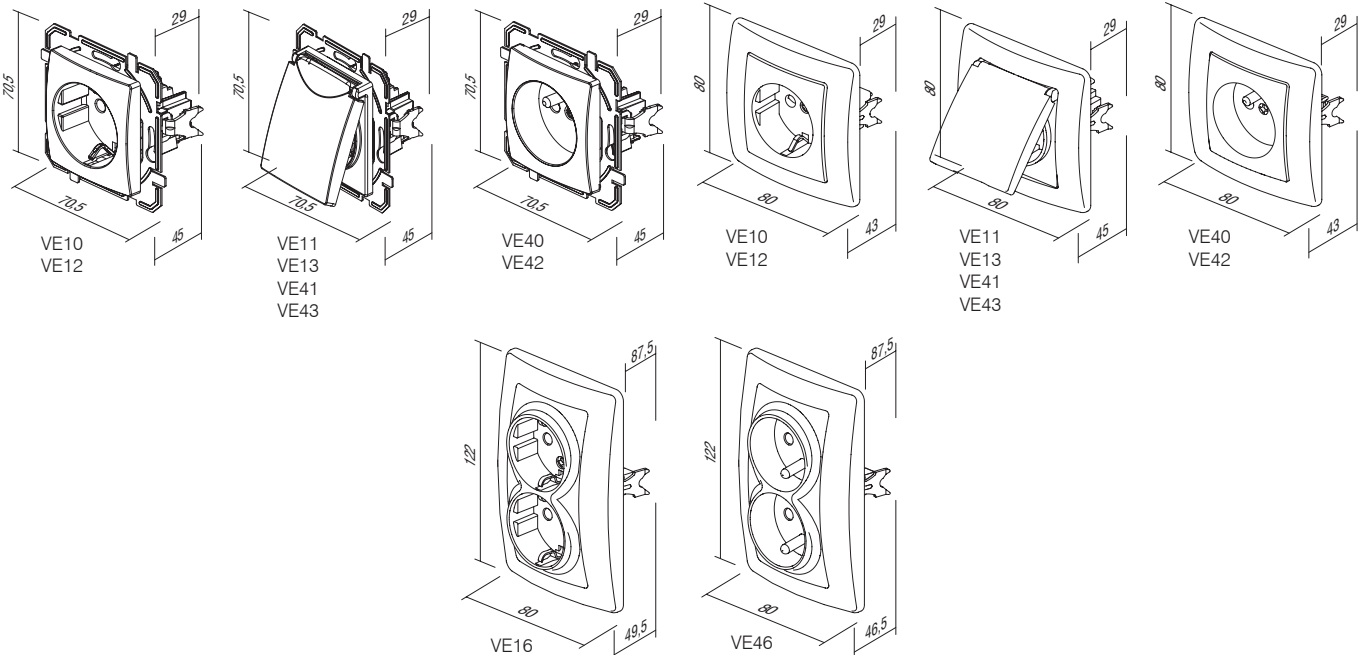

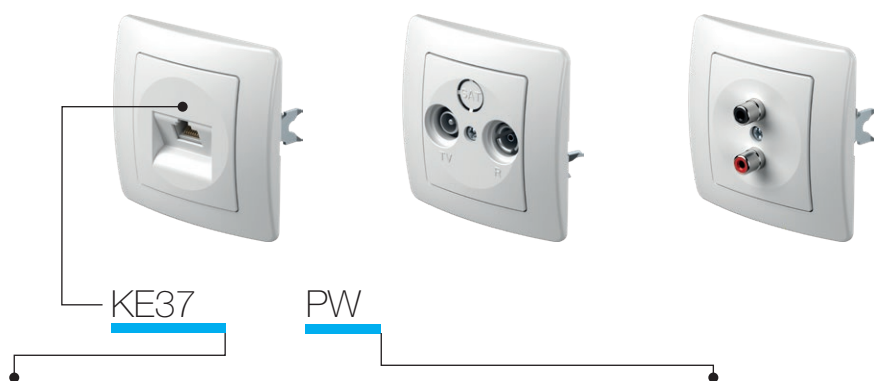

тип type	описание description	технически данни technical data	цвет colour
KE11	КОНЕКТОР ЗА ТВ-РАДИО КРАЕН SOCKET TV-R END-LINE	1dB	<input type="checkbox"/> PW снежнобял цвят polar white
KE12	КОНЕКТОР ЗА ТВ-РАДИО ПРЕХОДЕН SOCKET TV-R THROUGHPASS	10dB	<input type="checkbox"/> IW слонова кост ivory white
KE16	КОНЕКТОР ЗА СATEЛИТНА ТВ-РАДИО КРАЕН SOCKET SAT-TV-R END-LINE	3dB	<input type="checkbox"/> ES сребрист цвят с анодизирано покритие elox silver
⋮	⋮	⋮	<input type="checkbox"/> CO бял с термореактивен материал white thermoset
⋮	⋮	⋮	<input type="checkbox"/> NB тъмночерен night black

КОНЕКТОР ЗА ТВ-РАДИО КРАЕН 1 dB



KE11

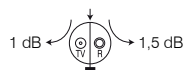

- за ТВ-радио краен
- честотен обхват 5-862 MHz
- затихване: Радио-1,5 dB, ТВ-1 dB
- в съответствие с EN 50083-1
- винтови контакти

SOCKET TV-R END-LINE 1dB

- TV-R end-line
- frequency range 5-862MHz
- reduction: R-1.5dB, TV-1dB
- in accordance with EN 50083-1
- screw contacts

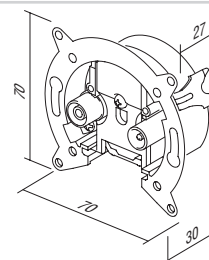

КОНЕКТОР ЗА ТВ-РАДИО ПРЕХОДЕН 10 dB



KE12

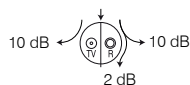

- преходник за ТВ-радио
- честотен обхват 5-862 MHz
- затихване: Радио-10 dB, ТВ-10 dB, преход-2 dB
- в съответствие с EN 50083-1
- винтови контакти

SOCKET TV-R TROUGHPASS 10dB

- TV-R troughpass
- frequency range 5-862MHz
- reduction: R-10dB, TV-10dB, trough-2dB
- in accordance with EN 50083-1
- screw contacts

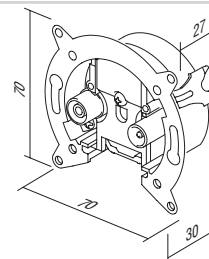

КОНЕКТОР ЗА САТЕЛИТНА ТВ-РАДИО КРАЕН 3 dB



KE16

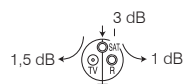

- за сателитна ТВ-радио краен
- честотен обхват 5-2400 MHz
- затихване: Радио-1dB, ТВ-1,5dB, сателитна ТВ-3 dB
- за монтаж в кръгла конзола Ø60 с крачета или винтове
- в съответствие с EN 50083-1
- винтови контакти

SOCKET SAT-TV-R END-LINE 3dB

- SAT-TV-R end-line
- frequency range 5-2400MHz
- reduction: R-1dB, TV-1.5dB, SAT-3dB
- for mounting in round box Ø60 with claws or screws
- in accordance with EN 50083-1
- screw contacts

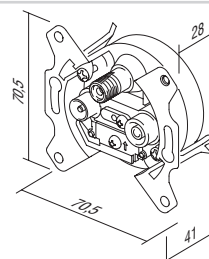

КОНЕКТОР ЗА ТЕЛЕФОН KS RJ11 6/4

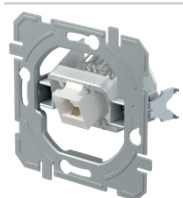

KE36

- KS модул стандарт за закрепване
- RJ11 6/4
- в съответствие с IEC 60603-7

SOCKET TEL KS RJ11 6/4

- KS keystone fixing standard
- RJ11 6/4
- in accordance with IEC 60603-7

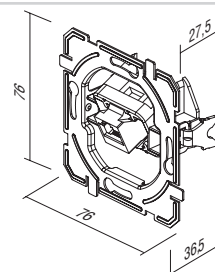

КОНЕКТОР CAT5e KS RJ45 8/8

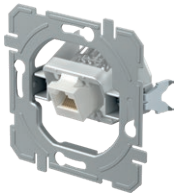

KE37

- KS модул стандарт за закрепване
- CAT5e, RJ45 8/8
- в съответствие с IEC 60603-7

SOCKET CAT5e KS RJ45 8/8

- KS keystone fixing standard
- CAT5e, RJ45 8/8
- in accordance with IEC 60603-7

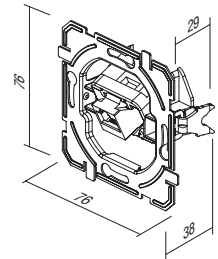

КОНЕКТОР CAT6s KS RJ45 8/8 SLIM

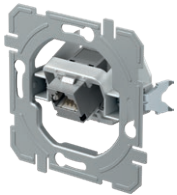

KE40

- KS модул стандарт за закрепване
- CAT6s, RJ45 8/8
- в съответствие с IEC 60603-7

SOCKET CAT6s KS RJ45 8/8 SLIM

- KS keystone fixing standard
- CAT6s, RJ45 8/8
- in accordance with IEC 60603-7

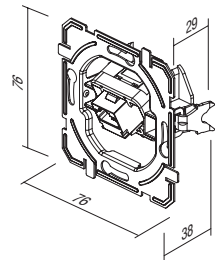

КОНЕКТОР ЗА ТЕЛЕФОН KS 2x RJ11 6/4

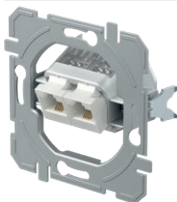

KE38

- KS модул стандарт за закрепване
- 2 x RJ11 6/4
- в съответствие с IEC 60603-7

SOCKET TEL KS DOUBLE 2x RJ11 6/4

- KS keystone fixing standard
- 2x RJ11 6/4
- in accordance with IEC 60603-7

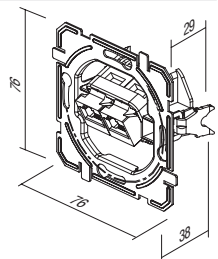

ДВОЕН КОНЕКТОР CAT5e KS 2x RJ45 8/8



KE39

- KS модул стандарт за закрепване
- 2 x CAT5e, RJ45 8/8
- в съответствие с IEC 60603-7

SOCKET CAT5e KS DOUBLE 2x RJ45 8/8

- KS keystone fixing standard
- 2x CAT5e, RJ45 8/8
- in accordance with IEC 60603-7

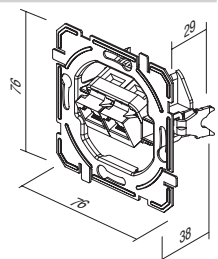

ДВОЕН КОНЕКТОР CAT6s KS 2x RJ45 8/8 SLIM

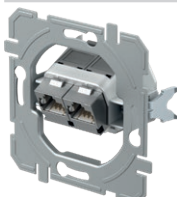

KE41

- KS модул стандарт за закрепване
- 2 x CAT6s, RJ45 8/8
- в съответствие с IEC 60603-7

SOCKET CAT6s KS DOUBLE 2x RJ45 8/8 SLIM

- KS keystone fixing standard
- 2x CAT6s, RJ45 8/8
- in accordance with IEC 60603-7

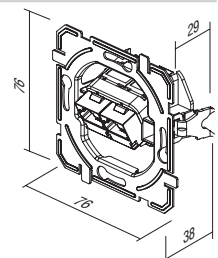

АДАПТЕР KS ЕДИНИЧЕН

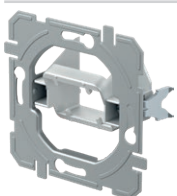

KE45

- KS модул стандарт за закрепване – единичен
- AMP, Avaya, Brandrex, FMT, Mfico, Tyco, ...
- комуникационният модул не е включен в доставката

ADAPTER KS SINGLE

- KS keystone fixing standard - single
- AMP, Avaya, Brandrex, FMT, Mfico, Tyco, ...
- communication module not included

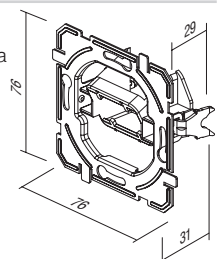

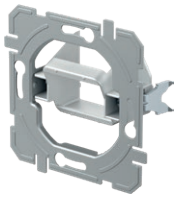

KE46

АДАПТЕР KS ДВОЕН

- KS модулен стандарт за закрепване – двоен
- AMP, Tyco, ...
- комуникационният модул не е включен в доставката

ADAPTER KS DOUBLE

- KS keystone fixing standard - double
- AMP, Tyco, ...
- communication module not included

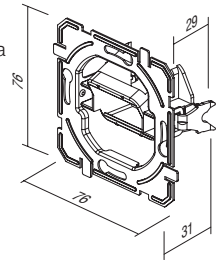

KE47

АДАПТЕР PD ДВОЕН

- стандарт за закрепване PD Panduit Mini-COM – двоен
- комуникационният модул не е включен в доставката

ADAPTER PD DOUBLE

- PD Panduit Mini-COM fixing standard - double
- communication module not included

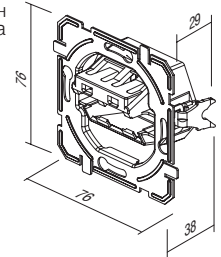

КОНЕКТОР ЗА ТВ ОСНОВЕН 0 dB



- KE10PW
- KE10IW
- KE10ES
- KE10CO
- KE10NB

- контакт за ТВ базов
- затихване 0 dB
- заден конектор – стандарт F

SOCKET TV BASIC 0dB

- TV basic
- reduction 0dB
- back connector – F standard



КОНЕКТОР ЗА ТВ-РАДИО КРАЕН 1 dB



- KE11PW
- KE11IW
- KE11ES
- KE11CO
- KE11NB

- за ТВ-радио краен
- честотен обхват 5÷862 MHz
- затихване: Радио-1,5 dB, ТВ-1 dB
- в съответствие с EN 50083-1
- винтови контакти

SOCKET TV-R END-LINE 1dB

- TV-R end-line
- frequency range 5÷862 MHz
- reduction: R-1.5dB, TV-1dB
- in accordance with EN 50083-1
- screw contact



КОНЕКТОР ЗА ТВ-РАДИО ПРЕХОДЕН 10 dB



- KE12PW
- KE12IW
- KE12ES
- KE12CO
- KE12NB

- преходник за ТВ-радио
- честотен обхват 5÷862 MHz
- затихване: Радио-10 dB, ТВ-10 dB, преход-2 dB
- в съответствие с EN 50083-1
- винтови контакти

SOCKET TV-R TROUGH-PASS 10dB

- TV-R troughpass
- frequency range 5÷862 MHz
- reduction: R-10dB, TV-10dB, trough-2dB
- in accordance with EN 50083-1
- screw contacts



КОНЕКТОР ЗА САТЕЛИТНА ТВ-ТВ-РАДИО КРАЕН 3 dB



- KE16PW
- KE16IW
- KE16ES
- KE16CO
- KE16NB

- за сателитна ТВ-ТВ-радио краен
- честотен обхват 5÷2400 MHz
- затихване: Радио-1dB, ТВ-1,5dB, сателитна ТВ-3 dB
- в съответствие с EN 50083-1
- винтови контакти

SOCKET SAT-TV-R END-LINE 3dB

- SAT-TV-R end-line
- frequency range 5÷2400 MHz
- reduction: R-1dB, TV-1.5dB, SAT-3dB
- in accordance with EN 50083-1
- screw contacts



КОНЕКТОР ЗА АУДИОСИГНАЛИ 2xRCA



- KE22PW
- KE22IW
- KE22ES
- KE22CO
- KE22NB

- за аудиосигнали, 2xRCA
- свързване на кабела чрез запояване

SOCKET AUDIO 2xRCA

- audio 2xRCA
- soldering connection of cable



КОНЕКТОР ЗА ВИСОКОГОВОРТЕЛИ



- KE23PW
- KE23IW
- KE23ES
- KE23CO
- KE23NB

- за аудиосигнали, 2x Ø4 mm
- за проводник за високоговорители, с щепсел тип банан Ø4 mm или плоски конектори
- свързване на кабела от задната страна чрез запояване

SOCKET AUDIO LOUDSPEAKERS

- audio 2x Ø4mm
- to accommodate speaker wire, banana plug Ø4mm or spades
- soldering connection of cable at the back side



КОНЕКТОР ЗА ТЕЛЕФОН KS RJ11 6/4

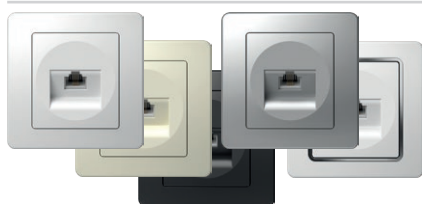

- KE36PW
- KE36IW
- KE36ES
- KE36CO
- KE36NB

- KS модул стандарт за закрепване
- RJ11 6/4
- в съответствие с IEC 60603-7

SOCKET TEL KS RJ11 6/4

- KS keystone fixing standard
- RJ11 6/4
- in accordance with IEC 60603-7





- KE37PW
- KE37IW
- KE37ES
- KE37CO
- KE37NB

КОНЕКТОР CAT5e KS RJ45 8/8

- KS модулен стандарт за закрепване
- CAT5e, RJ45 8/8
- в съответствие с IEC 60603-7

SOCKET CAT5e KS RJ45 8/8

- KS keystone fixing standard
- CAT5e, RJ45 8/8
- in accordance with IEC 60603-7

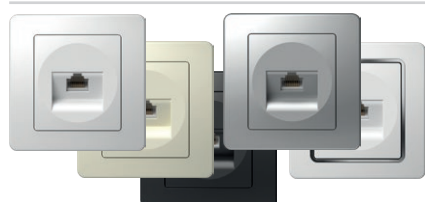

- KE40PW
- KE40IW
- KE40ES
- KE40CO
- KE40NB

КОНЕКТОР CAT6s KS RJ45 8/8 SLIM

- KS модулен стандарт за закрепване
- CAT6s, RJ45 8/8
- в съответствие с IEC 60603-7

SOCKET CAT6s KS RJ45 8/8 SLIM

- KS keystone fixing standard
- CAT6s, RJ45 8/8
- in accordance with IEC 60603-7

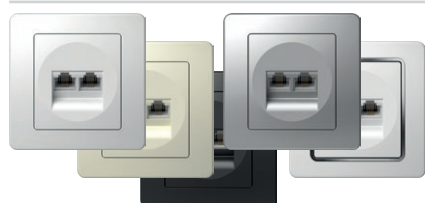

- KE38PW
- KE38IW
- KE38ES
- KE38CO
- KE38NB

КОНЕКТОР ЗА ТЕЛЕФОН KS 2x RJ11 6/4

- KS модулен стандарт за закрепване
- 2x RJ11, 6/4
- в съответствие с IEC 60603-7

SOCKET TEL KS DOUBLE 2x RJ11 6/4

- KS keystone fixing standard
- 2x RJ11, 6/4
- in accordance with IEC 60603-7



- KE39PW
- KE39IW
- KE39ES
- KE39CO
- KE39NB

ДВОЕН КОНЕКТОР CAT5e KS 2x RJ45 8/8

- KS модулен стандарт за закрепване
- 2x CAT5e, RJ45 8/8
- в съответствие с IEC 60603-7

SOCKET CAT5e KS DOUBLE 2x RJ45 8/8

- KS keystone fixing standard
- 2x CAT5e, RJ45 8/8
- in accordance with IEC 60603-7



- KE41PW
- KE41IW
- KE41ES
- KE41CO
- KE41NB

ДВОЕН КОНЕКТОР CAT6s KS 2x RJ45 8/8 SLIM

- KS модулен стандарт за закрепване
- 2x CAT6s, RJ45 8/8
- в съответствие с IEC 60603-7

SOCKET CAT6s KS DOUBLE 2x RJ45 8/8 SLIM

- KS keystone fixing standard
- 2x CAT6s, RJ45 8/8
- in accordance with IEC 60603-7

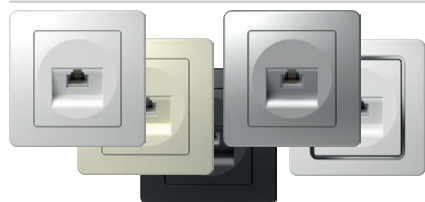

- KE35PW
- KE35IW
- KE35ES
- KE35CO
- KE35NB

КОНЕКТОР TEL LT RJ11 6/4

- телефонен LT винтов
- винтови контакти
- RJ11 6/4
- в съответствие с IEC 60603-7

SOCKET TEL LT RJ11 6/4

- TEL LT screw
- screw contacts
- RJ11 6/4
- in accordance with IEC 60603-7

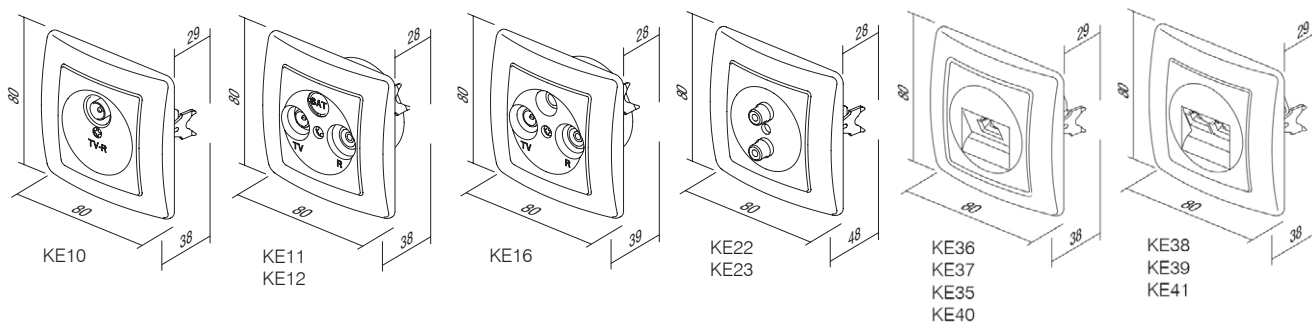

ПАНЕЛИ ЗА КОМУНИКАЦИИ КЕ



PE20

PW

тип type	описание description	технически данни technical data	ЦВЯТ colour
PE10	ПАНЕЛ ЗА ТВ-РАДИО COVER TV-R	2P/3P	<input type="checkbox"/> PW снежнобял цвят polar white
PE20	ПАНЕЛ KS ЕДИНИЧЕН COVER KS SINGLE		<input type="checkbox"/> IW слонова кост ivory white
PE21	ПАНЕЛ KS ДВОЕН COVER KS DOUBLE		<input type="checkbox"/> ES сребрист цвят с анодизирано покритие elox silver
⋮	⋮	⋮	<input type="checkbox"/> CO бял с термореактивен материал white thermoset
			<input type="checkbox"/> NB тъмночерен night black

ПАНЕЛ ЗА ТВ-РАДИО 2P/3P

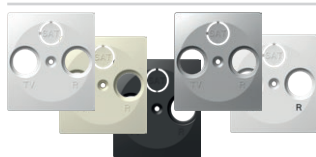

- PE10PW
- PE10IW
- PE10ES
- PE10CO
- PE10NB

- панел за ТВ-радио, 2P или 3P с винт

COVER TV-R 2P/3P

- TV-R cover, 2P or 3P with screw



ПАНЕЛ KS ЕДИНИЧЕН

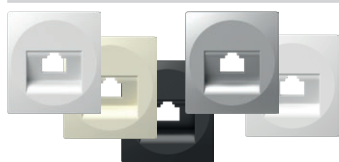

- PE20PW
- PE20IW
- PE20ES
- PE20CO
- PE20NB

- панел KS единичен

COVER KS SINGLE

- KS cover single



ПАНЕЛ KS ДВОЕН

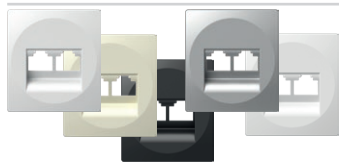

- PE21PW
- PE21IW
- PE21ES
- PE21NB

- панел KS двоен

COVER KS DOUBLE

- KS cover double



ПАНЕЛ TAE/TDO



- PE30PW
- PE30IW
- PE30ES
- PE30NB

- панел TAE или TDO с винт

COVER TAE/TDO

- TAE or TDO cover with screw

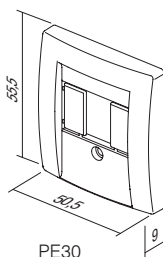

PE30

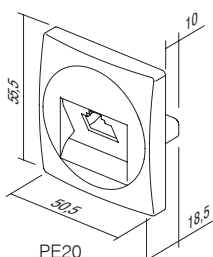

PE20

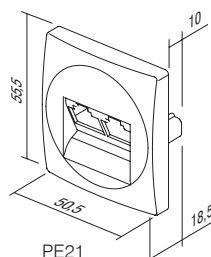

PE21

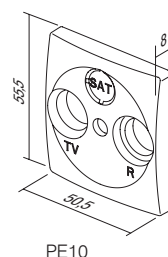

PE10

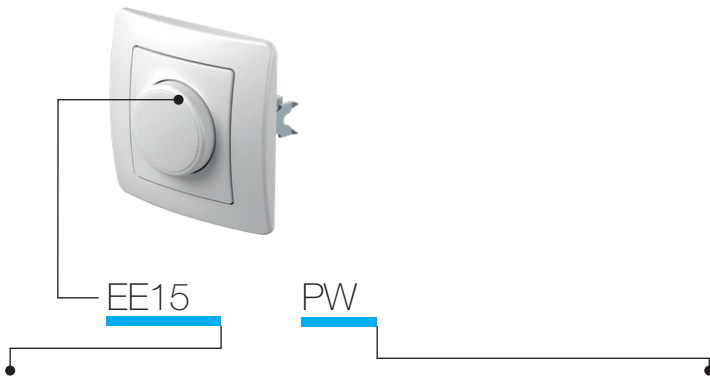

тип type	описание description	технически данни technical data	цвет colour
EE15	DIMMER ROTATIVE 2WAY DIMMER ROTATIVE 2WAY	RL 400W	<input type="checkbox"/> PW снежнобял цвят polar white
EE16	DIMMER ROTATIVE 2WAY DIMMER ROTATIVE 2WAY	RLC 400W	<input type="checkbox"/> IW слонова кост ivory white
EE19	DIMMER ROTATIVE 2WAY DIMMER ROTATIVE 2WAY	LED 100W	<input type="checkbox"/> ES сребрист цвят с анодизирано покритие elox silver
⋮	⋮	⋮	<input type="checkbox"/> CO бял с термореактивен материал white thermoset
⋮	⋮	⋮	<input type="checkbox"/> NB тъмночерен night black

ДИМЕР, ВЪРТЯЩ ТИП/ДВУПОСОЧЕН, АКТИВЕН/ИНДУКТИВЕН ТОВАР 400 W

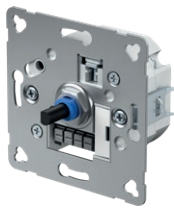

EE15

- управление чрез завъртане, с двупосочен ключ
- активен/индуктивен товар, 40 W – 400 W
- възможна е комбинация с двупосочен ключ
- не се допуска комбинация с допълнителни димери
- в съответствие с EN 60669-1 и EN 60669-2-1
- контакти чрез вкарване на проводниците 1,5 mm²
- захранващо напрежение 230 V[~] 50 Hz
- вътрешен диаметър на бутона Ø6 mm
- предпазител за смяна е включен в доставката

DIMMER ROTATIVE 2WAY RL 400W

- rotation control with 2-way switch
- load RL, 40W - 400W
- 2-way switch combination is possible
- more dimmers combination is not allowed
- in accordance with EN 60669-1 and EN 60669-2-1
- plug-in contacts 1.5mm²
- supply 230V[~] 50Hz
- button inner diameter Ø6mm
- replaceable fuse included

ДИМЕР, ВЪРТЯЩ ТИП/ДВУПОСОЧЕН, АКТИВЕН/ИНДУКТИВЕН/КАПАЦИТИВЕН ТОВАР 400 W

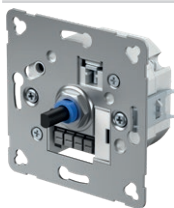

EE16

- управление чрез завъртане, с двупосочен ключ
- активен/индуктивен/капацитивен товар, 20 W – 400 W
- възможна е комбинация с двупосочен ключ
- не се допуска комбинация с допълнителни димери
- в съответствие с EN 60669-1 и EN 60669-2-1
- контакти чрез вкарване на проводниците 1,5 mm²
- захранващо напрежение 230 V[~] 50 Hz
- вътрешен диаметър на бутона Ø6 mm
- електронен предпазител

DIMMER ROTATIVE 2WAY RLC 400W

- rotation control with 2-way switch
- load RLC, 20W - 400W
- 2-way switch combination is possible
- more dimmers combination is not allowed
- in accordance with EN 60669-1 and EN 60669-2-1
- plug-in contacts 1.5mm²
- supply 230V[~] 50Hz
- button inner diameter Ø6mm
- electronic fuse



EE19

ДИМЕР, ВЪРТЯЩ ТИП/ДВУПОСОЧЕН, ЗА СВЕТОДИОДНО ОСВЕТЛЕНИЕ 100 W

- управление чрез завъртане, с двупосочен ключ
- товар: светодиодно осветление, 0 - 100 W (max. 10 светодиода)
GLS, 10-250 W
- възможна е комбинация с двупосочен ключ
- не се допуска комбинация с допълнителни димери
- в съответствие с EN 60669-1 и EN 60669-2-1
- контакти чрез вкарване на проводниците 1,5 mm²
- захранващо напрежение 230 V~ 50 Hz
- предпазител за смяна е включен в доставката
- вътрешен диаметър на бутона Ø6 mm

DIMMER ROTATIVE 2WAY LED 100W

- rotation control with 2-way switch
- load: LED, 0-100W (max. 10 LEDs)
GLS, 10-250W
- 2-way switch combination is possible
- more dimmers combination is not allowed
- in accordance with EN 60669-1 and EN 60669-2-1
- plug-in contacts 1.5mm²
- supply 230V~ 50Hz
- replaceable fuse included
- button inner diameter Ø6mm

IR КЛЮЧ 5 A 250 V~

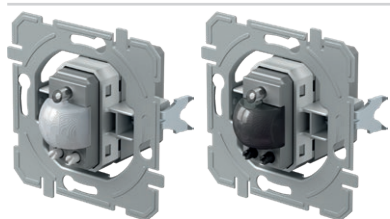

- EE32A1
- EE32A2

- инфрачервен ключ IR
- захранване: 230 V~ ±10 % 50 Hz
- реле: 5 A/250 V~ (нулевата стойност)
- клас на защита: IP40
- сечение на проводниците при контакта 0,75 - 2,5 mm²
- ъгъл на откриване: до 110° при 20° C
- разстояние на откриване: прилб. 8 m при 20° C
- регулируема продължителност: от прилб. 5 сек до 12 мин
- регулиране на яркостта на осветлението: от прилб. 5 до 200 лукса
- работна температура: от 0° C до +40° C
- не е подходящо за инсталиране в конзоли с дълбочина 45 mm
- само за използване на закрито

IR SWITCH 5A 230V~

- IR infrared switch
- supply voltage: 230V~ ±10 % 50Hz
- relay: 5A / 250V~ (zero crossing)
- protection rating: IP40
- cross-section of wires at the contact terminal: 0.75 - 2.5 mm²
- detection angle: up to 110° at 20°C
- detection area: approx. 8 m at 20°C
- adjustability of duration: from approx. 5 s to 12 min
- adjustability of brightness: from approx. 5 to 200 LUX
- operating temperature: from 0°C to +40°C
- not suitable for installation in 45 mm deep boxes
- only for indoor usage

USB ЗАХРАНВАЩ БЛОК 5V 2,4A



EE67

- за зареждане на електронни устройства чрез стандартен USB порт (съвместим с устройства на Apple)
- захранване: 100-230V~ 50/60Hz
- консумация на енергия:
300mA при 100V~/150mA при 230V~
- консумация на енергия в режим на готовност: 30mW при 230V~
- номинално изходно напрежение: 5 VCD (± 5%) SELV
- изходно напрежение на пулсации: 150 mV
- номинален изходен ток: 2,4A (±10%)
- вид конектор: USB A/USB A
- ефективност: максимум 77%
- температура на работа: 0°C/+45°C (за употреба в затворени пространства)
- Клас на IP защита: IP20, само за употреба в затворени пространства
- устройство клас II
- категория свръхнапрежение (EN 62109): Клас III
- контакти с винтови клеми: макс. 2,5 mm²
- устройство с контактна междина най-малко 3 mm
- в съответствие с Директива EN 60950-1 и Директива за безопасност на нисковолтови електрически съоръжения (LVD) и Директива относно електромагнитна съвместимост (EMC)

USB POWER SUPPLY UNIT 5V 2.4A

- for charging electronic devices via a standard USB port (also compatible with Apple devices)
- power supply: 100-230V~ 50/60Hz
- power consumption: 300mA at 100V~/150mA at 230V~
- standby power consumption: 30mW at 230V~
- nominal output voltage: 5 VCD (± 5%) SELV
- output ripple voltage: 150mV
- nominal output current: 2.4A (±10%)
- connector type: USB A / USB A
- efficiency: maximum of 77%
- operating temperature: 0°C/+45°C (indoor use)
- IP protection class: IP20, indoor use only
- class device II
- overvoltage category (EN 62109): Class III
- screw contacts: max. 2.5 mm²
- device with a contact gap of at least 3mm
- in accordance with the EN 60950-1 and LVD & EMC directives

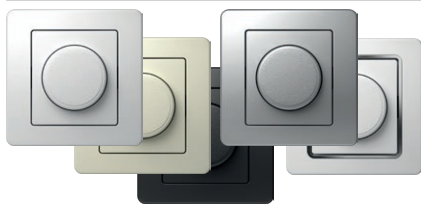

- EE15PW
- EE15IW
- EE15ES
- EE15CO
- EE15NB

ДИМЕР, ВЪРТЯЩ ТИП/ДВУПОСОЧЕН, АКТИВЕН/ИНДУКТИВЕН ТОВАР 400 W

- управление чрез завъртане, с двупосочен ключ
- активен/индуктивен товар, 40 W – 400 W
- възможна е комбинация с двупосочен ключ
- не се допуска комбинация с допълнителни димери
- в съответствие с EN 60669-1 и EN 60669-2-1
- контакти чрез вкарване на проводниците 1,5 mm²
- захранващо напрежение 230 V~ 50 Hz
- предпазител за смяна е включен в доставката



DIMMER ROTATIVE 2WAY RL 400W

- rotation control with 2-way switch
- load RL, 40W - 400W
- 2-way switch combination is possible
- more dimmers combination is not allowed
- in accordance with EN 60669-1 and EN 60669-2-1
- plug-in contacts 1.5mm²
- supply 230V~ 50Hz
- replaceable fuse included

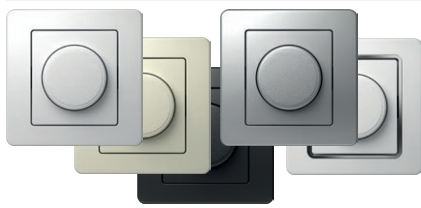

- EE16PW
- EE16IW
- EE16ES
- EE16CO
- EE16NB

ДИМЕР, ВЪРТЯЩ ТИП/ДВУПОСОЧЕН, АКТИВЕН/ИНДУКТИВЕН/КАПАЦИТИВЕН ТОВАР 400 W

- управление чрез завъртане, с двупосочен ключ
- активен/индуктивен/капацитивен товар, 20 W – 400 W
- възможна е комбинация с двупосочен ключ
- не се допуска комбинация с допълнителни димери
- в съответствие с EN 60669-1 и EN 60669-2-1
- контакти чрез вкарване на проводниците 1,5 mm²
- захранващо напрежение 230 V~ 50 Hz
- електронен предпазител



DIMMER ROTATIVE 2WAY RLC 400W

- rotation control with 2-way switch
- load RLC, 20W - 400W
- 2-way switch combination is possible
- more dimmers combination is not allowed
- in accordance with EN 60669-1 and EN 60669-2-1
- plug-in contacts 1.5mm²
- supply 230V~ 50Hz
- electronic fuse

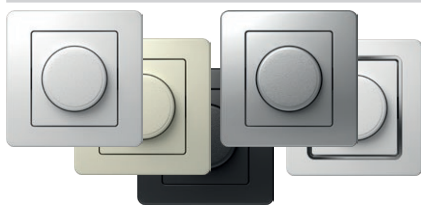

- EE19PW
- EE19IW
- EE19ES
- EE19CO
- EE19NB

ДИМЕР, ВЪРТЯЩ ТИП/ДВУПОСОЧЕН, ЗА СВЕТОДИОДНО ОСВЕТЛЕНИЕ 100 W

- управление чрез завъртане, с двупосочен ключ
- товар: светодиодно осветление, 0 - 100 W (max. 10 светодиода)
GLS, 10-250 W
- възможна е комбинация с двупосочен ключ
- не се допуска комбинация с допълнителни димери
- в съответствие с EN 60669-1 и EN 60669-2-1
- контакти чрез вкарване на проводниците 1,5 mm²
- захранващо напрежение 230 V~ 50 Hz
- предпазител за смяна е включен в доставката



DIMMER ROTATIVE 2WAY LED 100W

- rotation control with 2-way switch
- load: LED, 0-100W (max. 10 LEDs)
GLS, 10-250W
- 2-way switch combination is possible
- more dimmers combination is not allowed
- in accordance with EN 60669-1 and EN 60669-2-1
- plug-in contacts 1.5mm²
- supply 230V~ 50Hz
- replaceable fuse included



- EE32PW
- EE32IW
- EE32ES
- EE32CO
- EE32NB

IR КЛЮЧ 5 A 230V~

- инфрачервен ключ IR
- захранване: 230 V~ ±10 % 50 Hz
- реле: 5 A/250 V~ (нулевата стойност)
- клас на защита: IP40
- сечение на проводниците при контакта 0,75 - 2,5 mm²
- ъгъл на откриване: до 110° при 20° C
- разстояние на откриване: припл. 8 m при 20° C
- регулируема продължителност: от припл. 5 сек до 12 мин
- регулиране на яркостта на осветлението: от припл. 5 до 200 лукса
- работна температура: от 0° C до +40° C
- не е подходящо за инсталиране в конзоли с дълбочина 45 mm
- само за използване на закрито



IR SWITCH 5A 230V~

- IR infrared switch
- supply voltage: 230V~ ±10 % 50Hz
- relay: 5A / 250V~ (zero crossing)
- protection rating: IP40
- cross-section of wires at the contact terminal: 0.75 - 2.5 mm²
- detection angle: up to 110° at 20°C
- detection area: approx. 8 m at 20°C
- adjustability of duration: from approx. 5 s to 12 min
- adjustability of brightness: from approx. 5 to 200 LUX
- operating temperature: from 0°C to +40°C
- not suitable for installation in 45 mm deep boxes
- only for indoor usage



- EE67PW
- EE67IW
- EE67NB
- EE67ES

USB ЗАХРАНВАЩ БЛОК 5V 2,4A

- за зареждане на електронни устройства чрез стандартен USB порт (съвместим с устройства на Apple)
- захранване: 100-230V[~] 50/60Hz
- консумация на енергия:
 - 300mA при 100V[~]/150mA при 230V[~]
- консумация на енергия в режим на готовност: 30mW при 230V[~]
- номинално изходно напрежение: 5 VCD ($\pm 5\%$) SELV
- изходно напрежение на пулсации: 150 mV
- номинален изходен ток: 2,4A ($\pm 10\%$)
- вид конектор: USB A/USB A
- ефективност: максимум 77%
- температура на работа: 0°C/+45°C (за употреба в затворени пространства)
- Клас на IP защита: IP20, само за употреба в затворени пространства
- устройство клас II
- категория свръхнапрежение (EN 62109): Клас III
- контакти с винтови клеми: макс. 2,5 mm²
- устройство с контактна междина най-малко 3 mm
- в съответствие с Директива EN 60950-1 и Директива за безопасност на нисковолтови електрически съоръжения (LVD) и Директива относно електромагнитна съвместимост (EMC)



USB POWER SUPPLY UNIT 5V 2.4A

- for charging electronic devices via a standard USB port (also compatible with Apple devices)
- power supply: 100-230V[~] 50/60Hz
- power consumption: 300mA at 100V[~]/150mA at 230V[~]
- standby power consumption: 30mW at 230V[~]
- nominal output voltage: 5 VCD ($\pm 5\%$) SELV
- output ripple voltage: 150mV
- nominal output current: 2.4A ($\pm 10\%$)
- connector type: USB A / USB A
- efficiency: maximum of 77%
- operating temperature: 0°C/+45°C (indoor use)
- IP protection class: IP20, indoor use only
- class device II
- overvoltage category (EN 62109): Class III
- screw contacts: max. 2.5 mm²
- device with a contact gap of at least 3mm
- in accordance with the EN 60950-1 and LVD & EMC directives

EE15, EE16, EE19

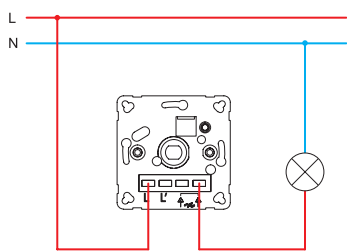

EE15, EE16, EE19

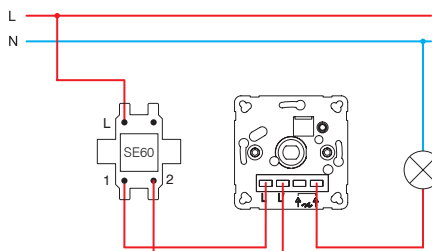

EE15, EE16, EE19

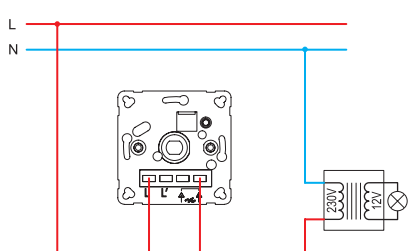

EE15, EE16, EE19

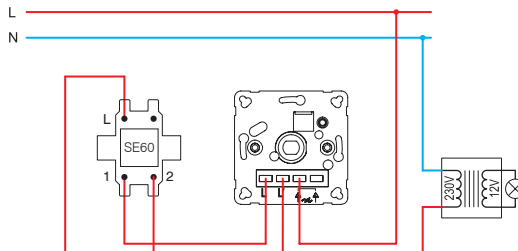

EE16, EE19

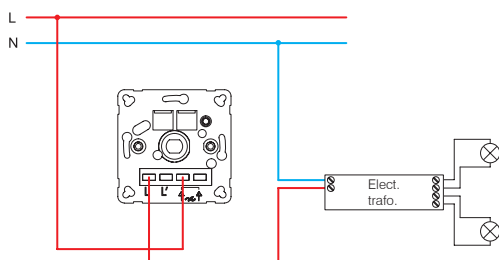

EE16, EE19

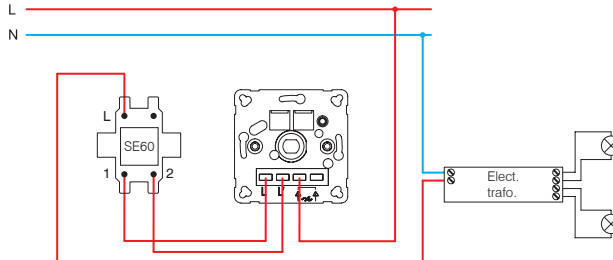

EE15 (40÷400W)

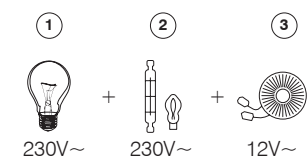

EE16 (20÷400W)

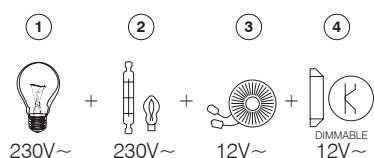

EE19 (GLS 10÷250W ; LED 0÷100W)

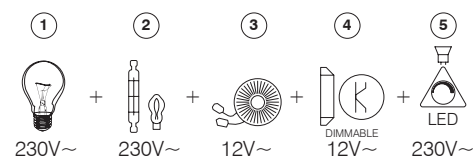

- 1 – лампа с нажежаема жичка / incandescent lamp
- 2 – халогенна лампа / halogen lamp

- 3 – класически трансформатор / classical transformer
- 4 – Димиращ електронен трансформатор / dimmable electronic transformer
- 5 – димируема светодиодна лампа / dimmable LED lamp

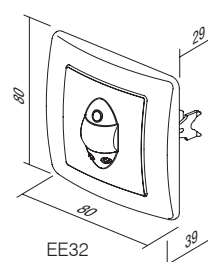
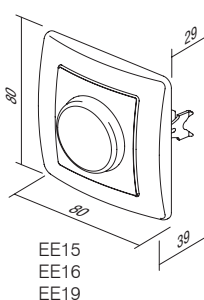
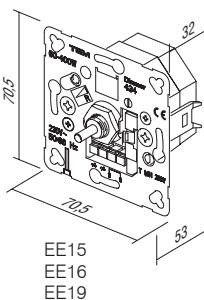
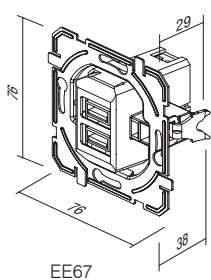

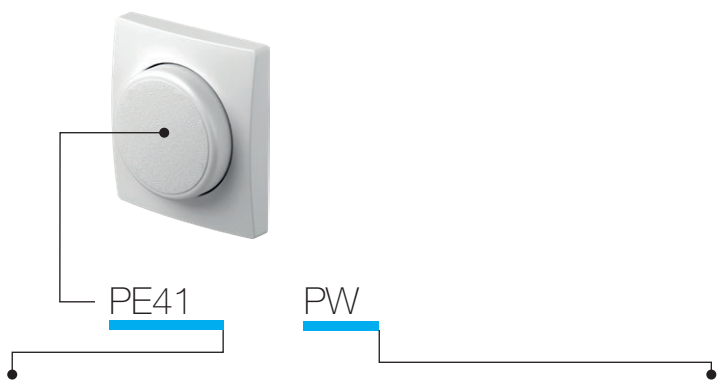

тип type	описание description	цвят colour
PE41	ПАНЕЛ ЗА ДИМЕР COVER DIMMER	<input type="checkbox"/> PW снежнобял цвят polar white <input type="checkbox"/> IW слонова кост ivory white <input type="checkbox"/> ES сребрист цвят с анодизирано покритие elox silver <input type="checkbox"/> CO бял с термореактивен материал white thermoset <input type="checkbox"/> NB тъмночерен night black



- PE41PW
- PE41IW
- PE41NB
- PE41ES
- PE41CO

ПАНЕЛ ЗА ДИМЕР Ø6

- панел за димер Ø6 mm
- за EE15, EE16, EE19

COVER DIMMER Ø6

- cover dimmer Ø6mm
- for EE15, EE16, EE19



- PE32PW
- PE32IW
- PE32NB
- PE32ES

ПАНЕЛ IR КЛЮЧ

- панел за ИЧ ключ

COVER IR SWITCH

- cover IR switch



- PE67PW
- PE67IW
- PE67NB
- PE67ES

КАПАК ЗА USB ЗАХРАНВАЩ БЛОК

- Капак за USB захранващ блок

USB SUPPLY UNIT COVER

- USB supply unit cover

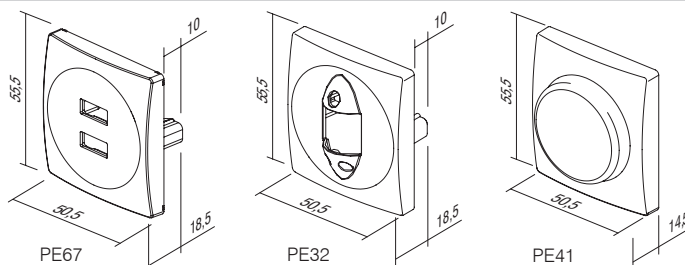

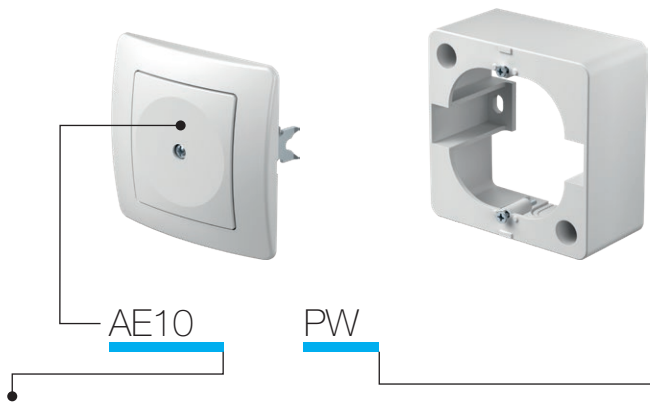

тип type	описание description	цвет colour
AE10	КАПАЧЕ BLANK	<input type="checkbox"/> PW снежнобял цвят polar white
AE20	СЪЕДИНИТЕЛНА КОНЗОЛА 5POLE 3P+N+E 5x4 mm ² CONNECTION BOX 3P+N+E 5X4mm ²	<input type="checkbox"/> IW слонова кост ivory white
AE30	КОНЗОЛА ЗА ВЪНШЕН МОНТАЖ 1 SURFACE MOUNT BOX	<input type="checkbox"/> ES сребрист цвят с анодизирано покритие elox silver
·	·	<input type="checkbox"/> CO бял с термореактивен материал white thermoset
·	·	<input type="checkbox"/> NB тъмночерен night black

КАПАЧЕ



- AE10PW
- AE10IW
- AE10NB
- AE10ES
- AE10CO

- за запълване на празни позиции

BLANK

- for filling up empty spaces

СЪЕДИНИТЕЛНА КОНЗОЛА 5POLE 3P+N+E 5x4 mm²

- AE20PW
- AE20IW

- съединителна конзола 3P+N+E
- 16 A 400 V
- в съответствие с VDE 0606-1:2000
- винтови контакти 1,5 - 4 mm²

CONNECTION BOX 5POLE 3P+N+E 5x4mm²

- 3P+N+E connection box
- 16A 400V
- in accordance with VDE 0606-1:2000
- screw contacts 1.5-4mm²



КОНЗОЛА ЗА ВЪНШЕН МОНТАЖ 1

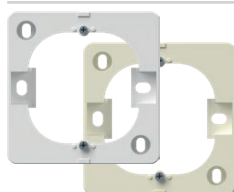

- AE30PW
- AE30IW

- конзола за външен монтаж

SURFACE MOUNT BOX 1

- surface mounting box



КУТИЯ ЗА МОНТАЖ НА ПОВЪРХНОСТИ ЗА ДВОЕН КОНТАКТ

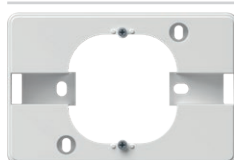

- AE31PW

- конзола за външен монтаж

SURFACE MOUNT BOX FOR

EKONOMIK DOUBLE SOCKET
- surface mounting box



СТЕННА ЗАЩИТА



- AE50PW
- AE50TS

- защитава повърхността около контакт или ключ

WALL PROTECTION

- protects surface around socket or switch

ЗАЩИТА ЗА ДЕЦА KS



- AE51PW
- AE51IW

- KS допълнителен елемент за защита за деца

CHILD PROTECTION KS

- KS additional child protection insert - shuttered live contacts

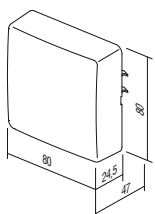

AE20

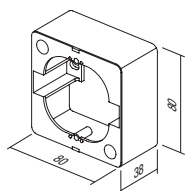

AE30

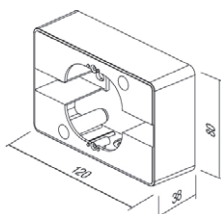

AE31

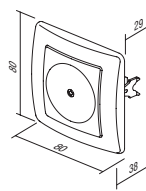

AE10

S U R R O U N D S O E

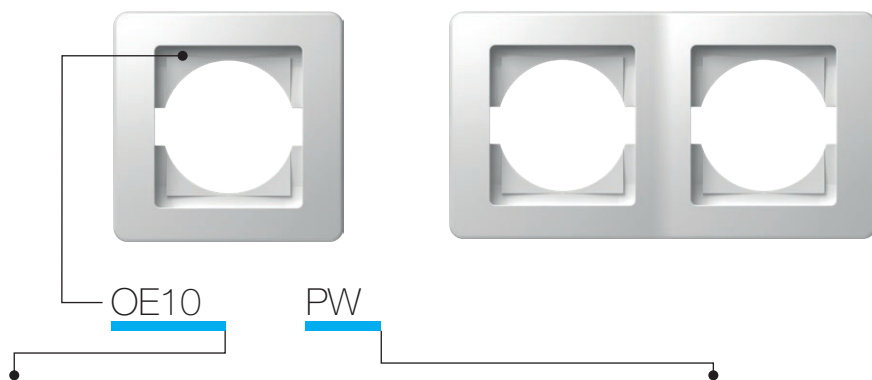

тип type	описание description	цвет colour
OE10	РАМКА ЕКОНОМИК 1 SURROUND EKONOMIK 1	<input type="checkbox"/> PW снежнобял цвят polar white
OE20	РАМКА ЕКОНОМИК 2 ХОРИЗОНТАЛНА SURROUND EKONOMIK 2 HORIZONTAL	<input type="checkbox"/> IW слонова кост ivory white
OE30	РАМКА ЕКОНОМИК 3 ХОРИЗОНТАЛНА SURROUND EKONOMIK 3 HORIZONTAL	<input type="checkbox"/> ES сребрист цвят с анодизирано покритие elox silver
·	·	<input type="checkbox"/> CO бял с термореактивен материал white thermoset
·	·	<input type="checkbox"/> NB тъмночерен night black

РАМКА ЕКОНОМИК 1



- OE10PW
- OE10IW
- OE10ES
- OE10CO
- OE10NB

- декоративна рамка единична
- в съответствие с EN 60669-1
SURROUND EKONOMIK 1
- decorative surround 1-gang
- in accordance with EN 60669-1

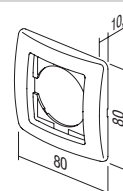

РАМКА ЕКОНОМИК 2 ХОРИЗОНТАЛНА



- OE20PW
- OE20IW
- OE20ES
- OE20CO
- OE20NB

- декоративна рамка двойна хоризонтална
- в съответствие с EN 60669-1
SURROUND EKONOMIK 2 HORIZONTAL
- decorative surround 2-gang horizontal
- in accordance with EN 60669-1

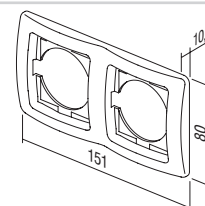

РАМКА ЕКОНОМИК 2 ВЕРТИКАЛНА



- OE21PW
- OE21IW
- OE21ES
- OE21CO
- OE21NB

- декоративна рамка двойна вертикална
- в съответствие с EN 60669-1
SURROUND EKONOMIK 2 VERTICAL
- decorative surround 2-gang vertical
- in accordance with EN 60669-1

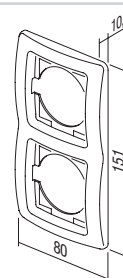

РАМКА ЕКОНОМИК 3 ХОРИЗОНТАЛНА



- OE30PW
- OE30IW
- OE30ES
- OE30CO
- OE30NB

- декоративна рамка тройна хоризонтална
- в съответствие с EN 60669-1
SURROUND EKONOMIK 3 HORIZONTAL
- decorative surround 3-gang horizontal
- in accordance with EN 60669-1

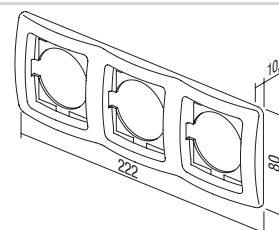



- OE31PW
- OE31IW
- OE31ES
- OE31CO
- OE31NB

РАМКА ЕКОНОМИК 3 ВЕРТИКАЛНА

- декоративна рамка тройна вертикална
- в съответствие с EN 60669-1

SURROUND EKONOMIK 3 VERTICAL

- decorative surround 3-gang vertical
- in accordance with EN 60669-1

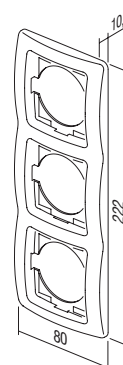

- OE40PW
- OE40IW
- OE40ES
- OE40NB

РАМКА ЕКОНОМИК 4 ХОРИЗОНТАЛНА

- декоративна рамка четворна хоризонтална
- в съответствие с EN 60669-1

SURROUND EKONOMIK 4 HORIZONTAL

- decorative surround 4-gang horizontal
- in accordance with EN 60669-1

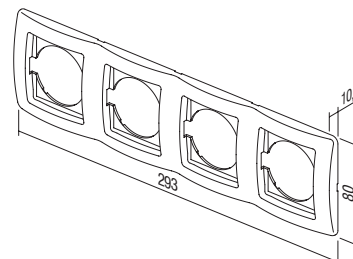

- OE41PW
- OE41IW
- OE41ES
- OE41NB

РАМКА ЕКОНОМИК 4 ВЕРТИКАЛНА

- декоративна рамка четворна вертикална
- в съответствие с EN 60669-1

SURROUND EKONOMIK 4 VERTICAL

- decorative surround 4-gang vertical
- in accordance with EN 60669-1

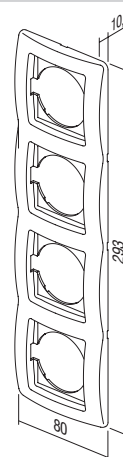

- OE50PW
- OE50IW
- OE50ES
- OE50NB

РАМКА ЕКОНОМИК 5 ХОРИЗОНТАЛНА

- декоративна рамка петорна хоризонтална
- в съответствие с EN 60669-1

SURROUND EKONOMIK 5 HORIZONTAL

- decorative surround 5-gang horizontal
- in accordance with EN 60669-1

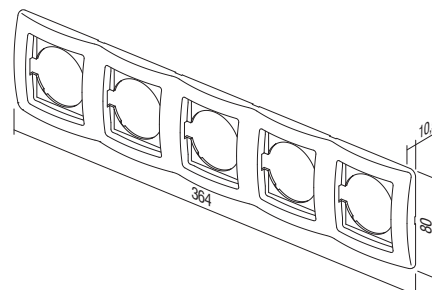

ЦВЕТНИ ДЕКОРАТИВНИ РАМКИ /
COLOR DECORATIVE FRAMES

OE90GR	ЗЕЛЕНА / GREEN	OE90YL	ЖЪЛТА / YELLOW	OE90MB	МЕТ. СИНЯ / MET. BLUE
OE90BL	СИНЯ / BLUE	OE90WH	БЯЛА / WHITE	OE90BZ	БРОНЗ / BRONZE
OE90VO	ВИОЛЕТОВА / VIOLET	OE90GY	СИВА / GREY	OE90CR	СРЕБРИСТА / SILVER
OE90PI	РОЗОВА / PINK	OE90BK	ЧЕРНА / BLACK	OE90GO	ЗЛАТИСТА / GOLD
OE90RD	ЧЕРВЕНА / RED				



TEM



КАТАЛОГ / CATALOGUE

fontana



КЛЮЧОВЕ SF
SWITCHES SF



218

КОНТАКТИ VF
SOCKETS VF



220

КОМПЛЕКТИ CF
SETS CF



221

ПРИНАДЛЕЖНОСТИ AF
ACCESSORIES AF



223

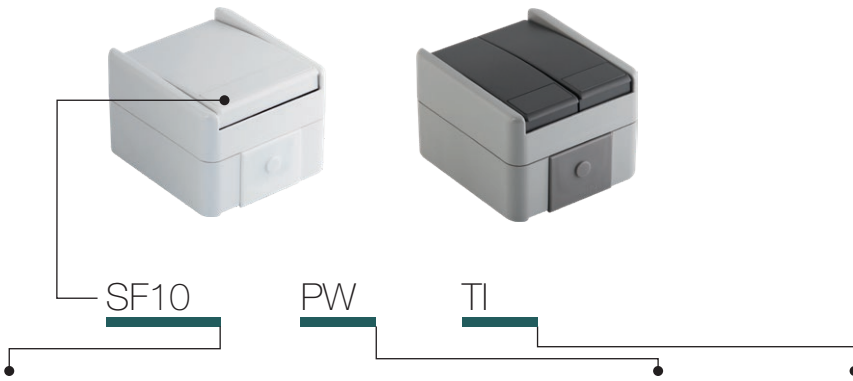

тип type	описание description	технически данни technical data	цвет colour	допълнителна информация 1 optional data 1
SF10	SWITCH 1WAY SWITCH 1WAY	IP44 10AX 250V~	<input type="checkbox"/> PW бял-матов white-mat	TI неонов лампа+индикация neon lamp+indication
SF11	PUSH BUTTON 1WAY PUSH BUTTON 1WAY	IP44 10A 250V~	<input type="checkbox"/> GY сив-матов grey-mat	
SF20	SWITCH 2POLE SWITCH 2POLE	IP44 10AX 250V~		
:	:	:		
:	:	:		

КЛЮЧ 1WAY IP44 10AX 250V~



- SF10PW
- SF10GY

- 10AX 250V~, тип SF10
- в съответствие с EN 60669-1
- контакти чрез вкарване 1,5 - 2,5 mm²

SWITCH 1WAY IP44 10AX 250V~
- 10AX 250V~, type SF10
- in accordance with EN 60669-1
- plug-in contacts 1.5-2.5mm²



КЛЮЧ 1WAY IP44 10AX 250V~ __ TI



- SF10PWTI
- SF10GYTI

- TI индикатор+неонова лампа
- 10AX 250V~, тип SF10
- в съответствие с EN 60669-1
- контакти чрез вкарване 1,5 - 2,5 mm²

SWITCH 1WAY IP44 10AX 250V~ __ TI
- TI indicator+neon lamp
- 10AX 250V~, type SF10
- in accordance with EN 60669-1
- plug-in contacts 1.5-2.5mm²



БУТОН 1WAY IP44 10A 250V~ __ TI



- SF11PWTI
- SF11GYTI

- TI индикатор+неонова лампа
- 10A 250V~, тип SF11
- в съответствие с EN 60669-1
- контакти чрез вкарване 1,5 - 2,5 mm²

PUSH BUTTON 1WAY IP44 10A 250V~ __ TI
- TI indicator+neon lamp
- 10A 250V~, type SF11
- in accordance with EN 60669-1
- plug-in contacts 1.5-2.5mm²



КЛЮЧ 2POLE IP44 10AX 250V~



- SF20PW
- SF20GY

- 10AX 250V~, тип SF20
- в съответствие с EN 60669-1
- контакти чрез вкарване 1,5 - 2,5 mm²

SWITCH 2POLE IP44 10AX 250V~
- 10AX 250V~, type SF20
- in accordance with EN 60669-1
- plug-in contacts 1.5-2.5mm²



	<input type="checkbox"/> SF50PW <input checked="" type="checkbox"/> SF50GY	КЛЮЧ 2GANG-1WAY IP44 10AX 250V~ - 10AX 250V~, тип SF50 - в съответствие с EN 60669-1 - контакти чрез вкарване 1,5 - 2,5 mm ²	
	<input type="checkbox"/> SF51PW <input checked="" type="checkbox"/> SF51GY	БУТОН 2GANG-1WAY IP44 10A 250V~ - 10 A 250 V~, тип SF51 - в съответствие с EN 60669-1 - контакти чрез вкарване 1,5 - 2,5 mm ²	
	<input type="checkbox"/> SF60PW <input checked="" type="checkbox"/> SF60GY	КЛЮЧ 2WAY IP44 10AX 250V~ - 10AX 250V~, тип SF60 - в съответствие с EN 60669-1 - контакти чрез вкарване 1,5 - 2,5 mm ²	
	<input type="checkbox"/> SF60PWTI <input checked="" type="checkbox"/> SF60GYTI	КЛЮЧ 2WAY IP44 10AX 250V~ __ TI - TI индикатор+неонова лампа - 10AX 250V~, тип SF60 - в съответствие с EN 60669-1 - контакти чрез вкарване 1,5 - 2,5 mm ²	
	<input type="checkbox"/> SF63PW <input checked="" type="checkbox"/> SF63GY	КЛЮЧ 2WAY DOUBLE IP44 10AX 250V~ - 10AX 250V~, тип SF63 - в съответствие с EN 60669-1 - контакти чрез вкарване 1,5 - 2,5 mm ²	
	<input type="checkbox"/> SF70PW <input checked="" type="checkbox"/> SF70GY	КРЪСТАТ КЛЮЧ IP44 10AX 250V~ - 10AX 250V~, тип SF70 - в съответствие с EN 60669-1 - контакти чрез вкарване 1,5 - 2,5 mm ²	

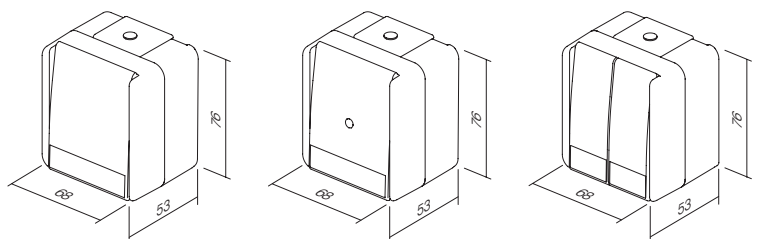

K O H T A K T I V F
S O C K E T S

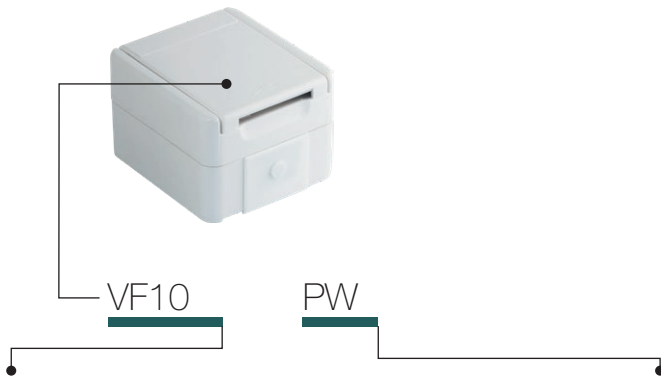

тип type	описание description	технически данни technical data	цвят colour
VF10	SOCKET SCHUKO+COVER SOCKET SCHUKO+COVER	IP44 2P+E 16A 250V~	<input type="checkbox"/> PW бял-матов white-mat <input type="checkbox"/> GY сив-матов grey-mat

КОНТАКТ SCHUKO+КАПАК IP44 2P+E 16A 250V~



- VF10PW
- VF10GY

- винтови контакти 1,5 - 2,5 mm²
- 2P+E шуко+капак
- 16A 250 V~, тип VF10
- в съответствие с EN 60884-1, CEE7

SOCKET SCHUKO+COVER IP44 2P+E 16A 250V~

- screw contacts 1.5-2.5mm²
- 2P+E schuko+cover
- 16A 250V~, type VF10
- in accordance with EN 60884-1, CEE7



КОНТАКТ SCHUKO+КАПАК IP44 2P+E 16A 250V~ BV



- VF12PW
- VF12GY

- BV контакти чрез вкарване 1,5 - 2,5 mm²
- 2P+E шуко+капак
- 16A 250 V~, тип VF12
- в съответствие с EN 60884-1, CEE7

SOCKET SCHUKO+COVER IP44 2P+E 16A 250V~ BV

- BV plug-in contacts 1.5-2.5mm²
- 2P+E schuko+cover
- 16A 250V~, type VF12
- in accordance with EN 60884-1, CEE7

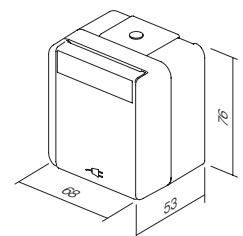

S E T S C F

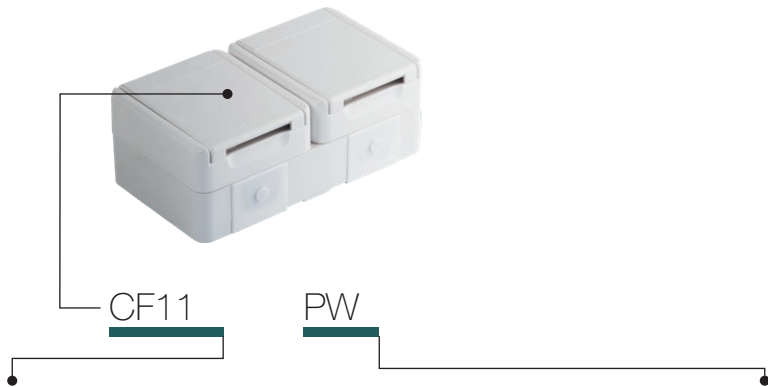

тип type	описание description	технически данни technical data	ЦВЯТ colour
CF10	SOCKET SET SCHUKO DOUBLE HORIZ SOCKET SET SCHUKO DOUBLE HORIZ	2x 2P+E 16A 250V~ IP44	<input type="checkbox"/> PW бял-матов white-mat
CF11	SOCKET SET SCHUKO DOUBLE VERT SOCKET SET SCHUKO DOUBLE VERT	2x 2P+E 16A 250V~ IP44	<input checked="" type="checkbox"/> GY сив-матов grey-mat
CF12	SOCKET SCH+SWITCH 2WAY HORIZ SOCKET SCH+SWITCH 2WAY HORIZ	16A + 10A 250V~ IP44	
⋮	⋮	⋮	
⋮	⋮	⋮	

КОМПЛЕКТ КОНТАКТИ ШУКО ДВОЙНИ ХОРИЗОНТАЛНИ IP44 2x 2P+E 16A 250V~



- CF10PW
- CF10GY

- винтови контакти 1,5 - 2,5 mm²
- 2x 2P+E шуко+капак хоризонтални
- 16A 250 V~, тип CF10
- в съответствие с EN 60884-1, CEE7

SOCKET SET SCHUKO DOUBLE
HORIZONTAL IP44 2x 2P+E 16A 250V~
- screw contacts 1.5-2.5mm²
- 2x 2P+E schuko+cover horizontal
- 16A 250V~, type CF10
- in accordance with EN 60884-1, CEE7



КОМПЛЕКТ КОНТАКТИ ШУКО ДВОЙНИ ВЕРТИКАЛНИ IP44 2x 2P+E 16A 250V~



- CF11PW
- CF11GY

- винтови контакти 1,5 - 2,5 mm²
- 2x 2P+E шуко+капак вертикални
- 16A 250 V~, тип CF11
- в съответствие с EN 60884-1, CEE7

SOCKET SET SCHUKO DOUBLE VERTICAL
IP44 2x 2P+E 16A 250V~
- screw contacts 1.5-2.5mm²
- 2x 2P+E schuko+cover vertical
- 16A 250V~, type CF11
- in accordance with EN 60884-1, CEE7



КОМПЛЕКТ КОНТАКТ ШУКО+КЛЮЧ ХОРИЗОНТАЛНИ 2WAY IP44 16A + 10AX 250V~



- CF12PW
- CF12GY

- винтове (контакта), чрез вкарване на проводниците (ключа) контакти 1,5 - 2,5 mm²
- 2P+E шуко+капак + ключ 2-way хоризонтални
- 16 A + 10AX 250 V~, тип CF12
- в съответствие с EN 60884-1, CEE7, EN 60669-1

SOCKET SCH+SWITCH SET 2WAY
HORIZONTAL IP44 16A + 10AX 250V~
- screw (socket), plug-in (switch)
contacts 1.5-2.5mm²
- 2P+E schuko+cover + switch 2-way horizontal
- 16A + 10AX 250V~, type CF12
- in accordance with EN 60884-1, CEE7, EN 60669-1



КОМПЛЕКТ КОНТАКТ ШУКО+КЛЮЧ ВЕРТИКАЛНИ IP44 16A + 10AX 250V~



- CF13PW
- CF13GY

- винтове (контакта), чрез вкарване на проводниците (ключа)
- контакти чрез вкарване 1,5 - 2,5 mm²
- 2P+E шуко+капак + ключ 2-way вертикални
- 16 A + 10AX 250 V~, тип CF13
- в съответствие с EN 60884-1, CEE7, EN 60669-1

SOCKET SCH+SWITCH 2WAY SET VERTICAL IP44 16A + 10AX 250V~

- screw (socket), plug-in (switch)
- contacts 1.5-2.5mm²
- 2P+E schuko+cover + switch 2-way vertical
- 16A + 10AX 250V~, type CF13
- in accordance with EN 60884-1, CEE7, EN 60669-1



КОМПЛЕКТ КОНТАКТИ ШУКО ДВОЙНИ ХОРИЗОНТАЛНИ IP44 2x 2P+E 16A 250V~ BV



- CF14PW
- CF14GY

- BV контакти чрез вкарване 1,5 - 2,5 mm²
- 2x 2P+E шуко+капак хоризонтални
- 16A 250 V~, тип CF14
- в съответствие с EN 60884-1, CEE7

SOCKET SET SCHUKO DOUBLE HORIZONTAL IP44 2x 2P+E 16A 250V~ BV

- BV plug-in contacts 1.5-2.5mm²
- 2x 2P+E schuko+cover horizontal
- 16A 250V~, type CF14
- in accordance with EN 60884-1, CEE7



КОМПЛЕКТ КОНТАКТИ ШУКО ДВОЙНИ ВЕРТИКАЛНИ IP44 2x 2P+E 16A 250V~ BV



- CF15PW
- CF15GY

- BV контакти чрез вкарване 1,5 - 2,5 mm²
- 2x 2P+E шуко+капак вертикални
- 16A 250 V~, тип CF15
- в съответствие с EN 60884-1, CEE7

SOCKET SET SCHUKO DOUBLE VERTICAL IP44 2x 2P+E 16A 250V~ BV

- BV plug-in contacts 1.5-2.5mm²
- 2x 2P+E schuko+cover vertical
- 16A 250V~, type CF15
- in accordance with EN 60884-1, CEE7



КОМПЛЕКТ КОНТАКТ ШУКО+КЛЮЧ ХОРИЗОНТАЛНИ 2WAY IP44 16A + 10AX 250V~ BV



- CF16PW
- CF16GY

- BV контакти чрез вкарване 1,5 - 2,5 mm²
- 2P+E шуко+капак + ключ 2-way хоризонтални
- 16 A + 10AX 250 V~, тип CF16
- в съответствие с EN 60884-1, CEE7, EN 60669-1

SOCKET+SWITCH SET SCH+2WAY HORIZONTAL IP44 16A + 10AX 250V~ BV

- BV plug-in contacts 1.5-2.5mm²
- 2P+E schuko+cover + switch 2-way horizontal
- 16A + 10AX 250V~, type CF16
- in accordance with EN 60884-1, CEE7, EN 60669-1



КОМПЛЕКТ КОНТАКТ ШУКО+КЛЮЧ 2WAY ВЕРТИКАЛНИ IP44 16A + 10AX 250V~ BV



- CF17PW
- CF17GY

- BV контакти чрез вкарване 1,5 - 2,5 mm²
- 2P+E шуко+капак + ключ 2-way вертикални
- 16 A + 10AX 250 V~, тип CF17
- в съответствие с EN 60884-1, CEE7, EN 60669-1

SOCKET SCH+SWITCH 2WAY SET VERTICAL IP44 16A + 10AX 250V~ BV

- BV plug-in contacts 1.5-2.5mm²
- 2P+E schuko+cover + switch 2-way vertical
- 16A + 10AX 250V~, type CF17
- in accordance with EN 60884-1, CEE7, EN 60669-1



П Р И Н А Д Л Е Ж Н О С Т И А Ф

A C C E S S O R I E S

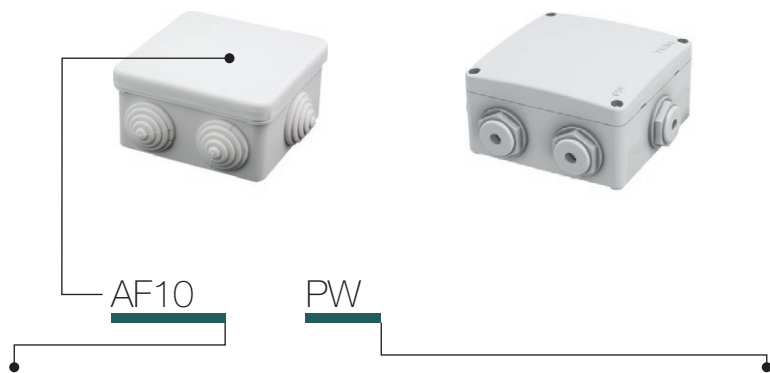

тип type	описание description	технически данни technical data	цвят colour
AF10	DISTRIBUTION BOX DISTRIBUTION BOX	IP44 RN01	<input type="checkbox"/> PW бял-матов white-mat
AF20	DISTRIBUTION BOX DISTRIBUTION BOX	IP55 NDO1	<input type="checkbox"/> GY сив-матов grey-mat

РАЗПРЕДЕЛИТЕЛНА КУТИЯ IP44 RN01



- AF10PW
- AF10GY

- разпределителна кутия за външен монтаж IP44
- 16 A 400 V~
- в съответствие с IEC/EN 60670-1, IEC/EN 60670-22
DISTRIBUTION BOX IP44 RN01
- surface mounting distribution box IP44
- 16A 400V~
- in accordance with IEC/EN 60670-1, IEC/EN 60670-22

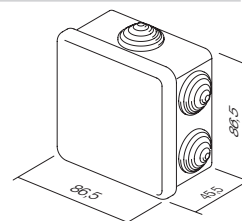

РАЗПРЕДЕЛИТЕЛНА КУТИЯ IP55 ND01



- AF20PW
- AF20GY

- съединителна кутия за външен монтаж IP55
- кабелните щучери са включени в доставката
- в съответствие с IEC/EN 60670-1, IEC/EN 60670-22
DISTRIBUTION BOX IP55 ND01
- surface mounting connection box IP55
- glands included
- in accordance with IEC/EN 60670-1, IEC/EN 60670-22

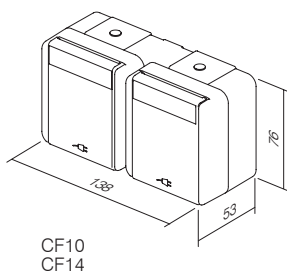
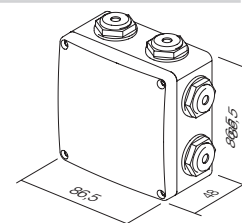

CF10
CF14

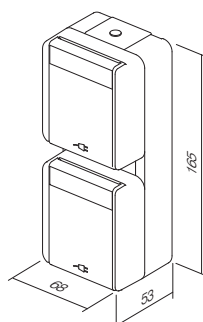

CF11
CF15

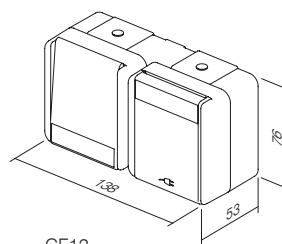

CF12
CF16

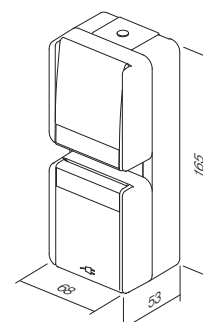

CF13
CF17

код	описание на продукта	страница	код	описание на продукта	страница
КЛЮЧОВЕ SM			КОМУНИКАЦИИ КМ		
SM10	КЛЮЧ 1WAY 16AX 250V~ 1M	68	KM10-	КОНЕКТОР ЗА ТВ ОСНОВЕН 0 dB 1M	82
SM11	БУТОН 1WAY 16A 250V~ 1M	68	KM20-	КОНЕКТОР ЗА ТВ ОСНОВЕН 0 dB 2M	82
SM12	КЛЮЧ 1WAY 20A 250V~ 1M	68	KM11-	КОНЕКТОР ЗА ТВ КРАЕН 1 dB 1M	82
SM20	КЛЮЧ 2POLE 16AX 250V~ 1M	68	KM12-	КОНЕКТОР ЗА ТВ ПРЕХОДЕН 10 dB 1M	82
SM40	КЛЮЧ ЗА ЩОРИ 1-0-2 16AX 250V~ 1M	69	KM15-	КОНЕКТОР ЗА САТЕЛИТНА ТВ ОСНОВЕН 0 dB 1M	83
SM41	БУТОН ЗА ЩОРИ 1-0-2 16A 250V~ 1M	69	KM24-	КОНЕКТОР ЗА САТЕЛИТНА ТВ ОСНОВЕН 0 dB 2M	83
SM60	КЛЮЧ 2WAY 16AX 250V~ 1M	69	KM16-	КОНЕКТОР ЗА САТЕЛИТНА ТВ КРАЕН 1 dB 1M	83
SM61	БУТОН 2WAY 16A 250V~ 1M	69	KM19-	КОНЕКТОР ЗА РАДИО ОСНОВЕН 0 dB 1M	83
SM70	КРЪСТАТ КЛЮЧ 16AX 250V~ 1M	69	KM29-	КОНЕКТОР ЗА РАДИО ОСНОВЕН 0 dB 2M	83
SM10-	КЛЮЧ 1WAY 16AX 250V~ 1M	70	KM25-	КОНЕКТОР ЗА САТЕЛИТНА ТВ КРАЕН 1 dB 2M	83
SM10-IN	КЛЮЧ 1WAY 16AX 250V~ 1M IN	70	KM22-	КОНЕКТОР ЗА АУДИОСИГНАЛИ 2xRCA 1M	84
SM11-	БУТОН 1WAY 16A 250V~ 1M	70	KM23-	КОНЕКТОР ЗА ВИСОКОГОВОРИТЕЛИ 1M	84
SM11-IN01	БУТОН 1WAY 16A 250V~ 1M IN 01	70	KM26-	КОНЕКТОР ЗА ВИСОКОГОВОРИТЕЛИ 2M	84
SM11-IN02	БУТОН 1WAY 16A 250V~ 1M IN 02	71	KM30-	КОНЕКТОР ЗА ТЕЛЕФОН LT RJ11 6/4 1M	85
SM20-NT03	КЛЮЧ 2POLE 16AX 250V~ 1M NT 03	71	KM31-	КОНЕКТОР ЗА ТЕЛЕФОН VT SEC 6/6 1M	85
SM20-IN	КЛЮЧ 2POLE 16AX 250V~ 1M IN	71	KM36-	КОНЕКТОР ЗА ТЕЛЕФОН KS RJ11 6/4 1M	85
SM40-NT10	КЛЮЧ ЗА ЩОРИ 1-0-2 16AX 250V~ 1M NT 10	71	KM37-	КОНЕКТОР CAT5e KS RJ45 8/8 1M	85
SM41-NT10	БУТОН ЗА ЩОРИ1-0-2 16A 250V~ 1M NT 10	71	KM35-	АДАПТЕР KS 1M	85
SM60-	КЛЮЧ 2WAY 16AX 250V~ 1M	71	KM38-	АДАПТЕР KS СЪС ЗАЩИТА ПРОТИВ ПРАХ 1M	85
SM61-	БУТОН 2WAY 16A 250V~ 1M	72	KM39-	КОНЕКТОР CAT6 SCH KS RJ45 8/8 1M	86
SM62-CD	БУТОН 2WAY С ШНУР 16A 250V~ 1M __ CD	72	KM50-	УНИВЕРСАЛЕН АДАПТЕР KS UNIVERSAL 1M	86
SM70-	КРЪСТАТ КЛЮЧ 16AX 250V~ 1M	72	KM40-	АДАПТЕР PD 1M	86
БУТОНИ ТМ			KM43-	АДАПТЕР PD СЪС ЗАЩИТА ПРОТИВ ПРАХ 1M	86
TM11-	БУТОН 1M	73	KM46-	АДАПТЕР R&M 1M	86
TM11-IN	БУТОН 1M IN	73	KM52-	АДАПТЕР R&M CAT6A 1M	86
TM12-	БУТОН 2M	73	KM47-	АДАПТЕР R&M СЪС ЗАЩИТА ПРОТИВ ПРАХ 1M	87
TM12-IN	БУТОН 2M IN	73	KM53-	АДАПТЕР R&M CAT6A СЪС ЗАЩИТА ПРОТИВ ПРАХ 1M	87
TM13-IL	БУТОН 2M С ПАНЕЛ С НАДПИС	74	KM45-	АДАПТЕР LK 1M	88
TM15-	БУТОН 1M 2POLE	74	KA26	АДАПТЕР NEXANS/SCHRACK 2M	88
TM21-	КАПАЧЕ 1M	74	KM48-	АДАПТЕР AT&T SYSTIMAX СЪС ЗАЩИТА ПРОТИВ ПРАХ 1M	88
TM22-	КАПАЧЕ 2M	74	KM51-	КОНЕКТОР USB ТИП А 1M	88
TM31-	ИЗХОД ЗА КАБЕЛ 1M	74	КОМУНИКАЦИОННИ ПРИНАДЛЕЖНОСТИ КА		
ОСВЕТЛЕНИЕ IA			KA10	КОНЕКТОР KS RJ11 RJ11 6/4	89
IA100R	НЕОНОВА ЛАМПА 230 V~ 0,34 W	76	KA11	КОНЕКТОР KS CAT5e RJ45 8/8	89
IA20-	СВЕТОДИОДНА ЛАМПА 230 V AC/DC 0,4W	76	KA12	КОНЕКТОР KS CAT5eS RJ45 8/8	89
IA21-	СВЕТОДИОДНА ЛАМПА 24 V AC/DC 0,2W	76	KA15	КОНЕКТОР KS RJ45 SCHRACK RJ45 8/8	89
IA22-	СВЕТОДИОДНА ЛАМПА 12V AC/DC 0,10W	76	KA16	КОНЕКТОР KS RJ45 SCHRACK RJ45 8/8	89
IA50	RC ВЕРИГА 250 V	76	KA17	КОНЕКТОР KS CAT6a SCHRACK RJ45 8/8	89
КОНТАКТИ VM			KA18	КОНЕКТОР KS RJ45 SCHRACK RJ45 8/8	90
VM10-	КОНТАКТ ШУКО+KS 2P+E 16A 250V~ 2M	78	KA27	КОНЕКТОР KS HDMI	90
VM11-	КОНТАКТ ШУКО+KS+КАПАК 2P+E 16A 250V~ 2M	78	KA28	КАБЕЛ KS HDMI	90
VM20-	КОНТАКТ EURO+KS 2P 10A 250V~ 1M	79	ЕЛЕКТРОНИКА ЕМ		
VM40-	КОНТАКТ ФРЕНСКИ+KS 2P+E 16A 250V~ 2M	79	EM10-	ДИМЕР, ВЪРТЯЩ ТИП R 300W 1M	91
VM41-	КОНТАКТ ФРЕНСКИ+KS+КАПАК 2P+E 16A 250V~ 2M	79	EM12-	ДИМЕР, ВЪРТЯЩ ТИП/2WAY RL 300W 1M	91
VM30-	КОНТАКТ ИТАЛИАНСКИ P17/11+KS 2P+E 16A 250V~ 1M	79	EM13-	ДИМЕР, ВЪРТЯЩ ТИП/2WAY LED 60W 1M	92
VM31-	КОНТАКТ ШУКО/ИТАЛИАНСКИ P17/11+KS 2P+E 16A 250V~ 2M	79	EM14-	ДИМЕР, ВЪРТЯЩ ТИП/2WAY LED 180W 1M	92
VM32-	КОНТАКТ ШУКО/ИТАЛИАНСКИ P30+KS 2P+E 16A 250V~ 2M	80	EM15-	ДИМЕР, ВЪРТЯЩ ТИП, R 250W 1M	92
VM33-	КОНТАКТ ИТАЛИАНСКИ P11+KS 2P+E 10A 250V~ 1M	80	EM23	ДИМЕР, ВГРАДЕН R (250 W), (RC, RL 200VA)	93
VM21-	КОНТАКТ EURO/АМЕРИКАНСКИ+KS 2P 16A 250V~ 1M	80	EM18	ДИМЕРНО УСТРОЙСТВО ЗА СВЕТОДИОДИ 250W	93
VM52-	КОНТАКТ БРИТАНСКИ BS 1363+KS 2P+E 13A 250V~ 2M	80	EM19	ДИМЕРНО УСТРОЙСТВО ЗА СВЕТОДИОДИ, ПОСТОЯНЕН ТОК 96 W	93
VM80	УСТРОЙСТВО ЗА ЗАЩИТА СРЕЩУ ОТСКОЦИ НА НАПРЕЖЕНИЕТО MPE MINI 275V/50Hz	80	EM25-	КЛЮЧ/УНИВЕРСАЛЕН ДИМЕР RLC 0-300W 2M	95
			EM26-	БУТОННО УСТРОЙСТВО ЗА УПРАВЛЕНИЕ 2M	97
			EM27	ЧЕСТОТЕН ФИЛТЪР	97
			EM25PPOL20	КОМПЛЕКТ КЛЮЧ/УНИВЕРСАЛЕН ДИМЕР RLC 0-300W 2M PP OL20	97
			EM31-	КЛЮЧ IR SWITCH 5A 230V~ 1M	98
			EM32-	КЛЮЧ IR SWITCH 5A 230V~ 2M	98
			EM37-	КЛЮЧ ОСНОВЕН 6A 230 V~ 2M	100
			NM39	МОНТАЖНА РАМКА С ВИНТОВЕ ЗА ТЕРМОСТАТИ FANTINI COSMI 3M	101
			EM40-	КЛЮЧ С КАРТА ЗА ИКОНОМИЯ НА ЕНЕРГИЯ ЗА 250V~ 3M	101
			EM47	ISO КАРТА	101
			EM44-	КЛЮЧ С КАРТА ЗА ИКОНОМИЯ НА ЕНЕРГИЯ RF HF 13,56 Mhz 3M	102
			EM49	УСТРОЙСТВО ЗА УПРАВЛЕНИЕ ЗА ИКОНОМИЯ НА ЕНЕРГИЯ 2x16A 250V~	102
			EM45	РАЗПРЕДЕЛИТЕЛ SPL-1	102
			EM60-	КОНТАКТ ЗА САМОБРЪСНАЧКА 230V~/120V~ 3M	103
			EM66-	USB ЗАХРАНВАЩО УСТРОЙСТВО 5 V 2,1 A 1M	103
			EM67-	USB ЗАХРАНВАЩО УСТРОЙСТВО 5 V 2,4 A 1M	103
			EM68-	USB ЗАХРАНВАЩ БЛОК 5V 3,0A	104
			EM55	СВЕТОДИОДНО АВАРИЙНО ОСВЕТЛЕНИЕ 250 V~ 0,90 W, NiCd 3h 7M	104
			EM57	АВАРИЙНА СВЕТОДИОДНА ЛАМПА 230V~50 Hz, 0,5 W, NiMH 2h 2M	104
			EM50-	ЕДНОЦВЕТНА СВЕТОДИОДНА ЛАМПА 250V~ 0,8W 2M	105
			EM51-	ДВУЦВЕТНА СВЕТОДИОДНА ЛАМПА 250V~ 2x0,4W 2M	105
			EM52-	ДВУЦВЕТНА СВЕТОДИОДНА ЛАМПА 3D 250V~ 2x0,4W 2M	105
			EM71-	ПРЕВКЛЮЧВАТЕЛ С ПРЪСТОВ ОТПЕЧАТЪК BIOPASS 2M	106
			EM80-	БЕЗКОНТАКТЕН КЛЮЧ, 10 A 240 V~	107
			EM81-	БЕЗКОНТАКТЕН КЛЮЧ	107
			EM90-	ЗУМЕР 8VA 230V~ 1M	108
			EM91-	ЗУМЕР 8VA 12V~ 1M	108
			EM92-	ЗУМЕР 8VA 230V~ 1M	108
			EM93-	ЗУМЕР 8VA 12V~ 1M	108
			EM95-	РЕГУЛАТОР НА СИЛАТА НА ЗВУКА 100V AUDIO LINE 35W 2M	109
			EM96-	РЕГУЛАТОР НА СИЛАТА НА ЗВУКА 4 - 8 Q 35 W 2M	109

код	описание на продукта	страница	код	описание на продукта	страница
КОМПЛЕКТИ СМ			КУТИИ		
SM10-	КОМПЛЕКТ КОНТАКТИ 2 x ШУКО 2P+E 16A 250V~ 4M	110	КРЪГЛИ КОНЗОЛИ		
SM11-	КОМПЛЕКТ КОНТАКТИ 3 x ШУКО 2P+E 16A 250V~ 7M	110	DE10	КРЪГЛА КОНЗОЛА ЗА ТУХЛЕНИ СТЕНИ SM60-01	140
SM15	КОМПЛЕКТ СЪЕДИНИТЕЛНИ ПРОВОДНИЦИ 3x1,5 mm2 1M	111	DE11	КРЪГЛА КОНЗОЛА ЗА ТУХЛЕНИ СТЕНИ, ДЪЛБОКА SM60-06	140
SM16	КОМПЛЕКТ СЪЕДИНИТЕЛНИ ПРОВОДНИЦИ 3x2,5 mm2 2M	111	DE30	СОМБИ-CLIP SM60-03	140
SM17	КОМПЛЕКТ ВИНТОВЕ 3.5x20	111	DE31	СОМБИ-CLIP SM60-04	140
SM18	КОМПЛЕКТ ВИНТОВЕ 3.5x35	111	DE12	КРЪГЛА КОНЗОЛА ЗА ТУХЛЕНИ СТЕНИ 65-46	141
SM19	КОМПЛЕКТ ВИНТОВЕ 3.5x50	111	DE13	КРЪГЛА КОНЗОЛА ЗА ТУХЛЕНИ СТЕНИ 65-60	141
SM22-	КОМПЛЕКТ КЛЮЧОВЕ IP44 2M	111	DE14	ДОПЪЛНИТЕЛЕН ДЕТАЙЛ ЗА MD 65-46	141
SM23-	КОМПЛЕКТ КОНТАКТИ IP44 2M	111	DE32	СОМБИ-CLIP MD 65-71	141
SM25-OL	КОМПЛЕКТ КЛЮЧ ЗА БАНЯ 3 x 20A 250 V~ 4M OL	111	DE33	СОМБИ-CLIP MD 65-91	141
SM25-OS	КОМПЛЕКТ КЛЮЧ ЗА БАНЯ 3 x 20A 250 V~ 4M OS	111	DE20	ЗАЩИТЕН КАПАК ЗА КОНЗОЛА 60	141
NM41	МОНТАЖНА РАМКА ЗА КОМПЛЕКТ ЗА БАНЯ 4M	112	DE21	ЗАЩИТЕН КАПАК ЗА КОНЗОЛА 65	141
OL41-	ПАНЕЛ LINE ЗА КОМПЛЕКТ ЗА БАНЯ	112	DE22	ДЕКОРАТИВЕН КАПАК ЗА КОНЗОЛА SM60	141
OS41-	ПАНЕЛ SOFT ЗА КОМПЛЕКТ ЗА БАНЯ	112	HE10	КРЪГЛА КОНЗОЛА ЗА ТУХЛЕНИ СТЕНИ SM68x40	144
АНТИБАКТЕРИАЛНА ПРОГРАМА AW			HE11	КРЪГЛА КОНЗОЛА ЗА ТУХЛЕНИ СТЕНИ SM68x55	144
TM11AW	БУТОН 1M	115	BE10	КРЪГЛА КОНЗОЛА ЗА СТЕНИ ОТ БЕТОН 60-49	144
TM11AWIN	БУТОН 1M IN	115	BE11	КРЪГЛА КОНЗОЛА ЗА СТЕНИ ОТ БЕТОН 60-77	144
TM12AW	БУТОН 2M	115	BE20	ЗАДНА ОПОРА ЗА КОНЗОЛА ЗА СТЕНИ ОТ БЕТОН	144
TM12AWIN	БУТОН 2M IN	115	BE21	ОГРАНИЧИТЕЛ ЗА ТРЪЧИ ЗА КОНЗОЛИ ЗА СТЕНИ ОТ БЕТОН 16	144
TM21AW	КАПАЧЕ 1M	115	ПРАВОЪГЪЛНИ КОНЗОЛИ		
TM22AW	КАПАЧЕ 2M	115	DM30	ПРАВОЪГЪЛНА КОНЗОЛА ЗА ТУХЛЕНИ СТЕНИ PM3	148
VM10AW	КОНТАКТ ШУКО+KS 2P+E 16A 250V~ 2M	116	DM31	ПРАВОЪГЪЛНА КОНЗОЛА ЗА ТУХЛЕНИ СТЕНИ PM3-65	148
VM11AW	КОНТАКТ ШУКО+KS+КАПАК 2P+E 16A 250V~ 2M	116	DM40	ПРАВОЪГЪЛНА КОНЗОЛА ЗА ТУХЛЕНИ СТЕНИ PM4	148
VM20AW	КОНТАКТ EURO+KS 2P 10A 250V~ 1M	116	DM41	ПРАВОЪГЪЛНА КОНЗОЛА ЗА ТУХЛЕНИ СТЕНИ PM4-65	148
KM11AW	КОНЕКТОР ЗА ТВ КРАЕН 1 dB 1M	116	DM70	ПРАВОЪГЪЛНА КОНЗОЛА ЗА ТУХЛЕНИ СТЕНИ PM7	149
KM35AW	АДАПТЕР KS 1M	116	DM71	ПРАВОЪГЪЛНА КОНЗОЛА ЗА ТУХЛЕНИ СТЕНИ PM7-65	149
OS20AW	ПАНЕЛ SOFT 2M	117	DM72	ПРАВОЪГЪЛНА КОНЗОЛА ЗА ТУХЛЕНИ СТЕНИ PM72-65	149
OS24AW	ПАНЕЛ SOFT 2x2M	117	DM80	ДИСТАНЦИОНЕН ЕЛЕМЕНТ ЗА КОНЗОЛА PM	149
OS26AW	ПАНЕЛ SOFT 3x2M	117	DM33	ЗАЩИТЕН КАПАК ЗА КОНЗОЛА PM3	150
OS30AW	ПАНЕЛ SOFT 3M	117	DM34	ДЕКОРАТИВЕН КАПАК ЗА КОНЗОЛА PM3	150
OS40AW	ПАНЕЛ SOFT 4M	117	DM43	ЗАЩИТЕН КАПАК ЗА КОНЗОЛА PM4	150
OS70AW	ПАНЕЛ SOFT 7M	117	DM44	ДЕКОРАТИВЕН КАПАК ЗА КОНЗОЛА PM4	150
ПАНЕЛИ PURE OP			DM73	ЗАЩИТЕН КАПАК ЗА КОНЗОЛА PM7	150
OP20-	ПАНЕЛ PURE 2M	120	DM74	ДЕКОРАТИВЕН КАПАК ЗА КОНЗОЛА PM7	150
OP24-	ПАНЕЛ PURE 2x2M	120	DM75	ДЕКОРАТИВЕН КАПАК ЗА КОНЗОЛА PM72	151
OP26-	ПАНЕЛ PURE 3x2M	120	NM30	ПРАВОЪГЪЛНА КОНЗОЛА ЗА КУХИ СТЕНИ VM3	152
OP28-	ПАНЕЛ PURE 4x2M	120	NM40	ПРАВОЪГЪЛНА КОНЗОЛА ЗА КУХИ СТЕНИ VM4	152
OP30-	ПАНЕЛ PURE 3M	121	NM70	ПРАВОЪГЪЛНА КОНЗОЛА ЗА КУХИ СТЕНИ VM7	152
OP40-	ПАНЕЛ PURE 4M	121	NM72	ПРАВОЪГЪЛНА КОНЗОЛА ЗА КУХИ СТЕНИ VM72	152
OP70-	ПАНЕЛ PURE 7M	121	VM30	ПРАВОЪГЪЛНА КОНЗОЛА ЗА СТЕНИ ОТ БЕТОН VM3	153
OP13-	ПАНЕЛ PURE 1/3M	121	VM40	ПРАВОЪГЪЛНА КОНЗОЛА ЗА СТЕНИ ОТ БЕТОН VM4	153
OP23-	ПАНЕЛ PURE 2/3M	121	VM70	ПРАВОЪГЪЛНА КОНЗОЛА ЗА СТЕНИ ОТ БЕТОН VM7	153
ПРОДУКТОВА ГАМА ПАНЕЛИ OL			VM80	FIXING COMBI-CLIP VM	153
OL20-	ПАНЕЛ LINE 2M	124	VM82	ДИСТАНЦИОНЕН ЕЛЕМЕНТ ЗА КОНЗОЛИ VM	153
OL24-	ПАНЕЛ LINE 2x2M	124	СЪЕДИНИТЕЛНИ КУТИИ		
OL26-	ПАНЕЛ LINE 3x2M	124	DW10	КРЪГЛА СЪЕДИНИТЕЛНА КОНЗОЛА ЗА ТУХЛЕНИ СТЕНИ DSM78	156
OL28-	ПАНЕЛ LINE 4x2M	124	NW10	КРЪГЛА СЪЕДИНИТЕЛНА КОНЗОЛА ЗА КУХИ СТЕНИ SM78x45	156
OL29-	ПАНЕЛ LINE 5x2M	124	DE23	ДЕКОРАТИВЕН КАПАК ЗА КОНЗОЛА SM78	156
OL30-	ПАНЕЛ LINE 3M	125	DE24	ЗАЩИТЕН КАПАК ЗА КОНЗОЛА 78	156
OL40-	ПАНЕЛ LINE 4M	125	NW20	КВАДРАТНА СЪЕДИНИТЕЛНА КОНЗОЛА ЗА ТУХЛЕНИ СТЕНИ SM105x105	156
OL70-	ПАНЕЛ LINE 7M	125	ПРИНАДЛЕЖНОСТИ ЗА СВЪРЗВАНЕ		
QL10-	ПАНЕЛ LINE 1/2M	125	UW10-	1 РЕД КЛЕМОРЕДИ ЗАТВОРЕНИ PC 2x2,5 mm ² 10P	158
QL13-	ПАНЕЛ LINE 1/3M	125	UW11-	1 РЕД КЛЕМОРЕДИ ЗАТВОРЕНИ PC 2x4 mm ² 10P	158
QL23-	ПАНЕЛ LINE 2/3M	125	UW12-	1 РЕД КЛЕМОРЕДИ ЗАТВОРЕНИ PC 2x6 mm ² 10P	158
ПАНЕЛИ SOFT OS			UW15-	1 РЕД КЛЕМОРЕДИ PA 2x2,5 mm ² 12P	158
OS20-	ПАНЕЛ SOFT 2M	128	UW16-	1 РЕД КЛЕМОРЕДИ PA 2x4 mm ² 12P	158
OS24-	ПАНЕЛ SOFT 2x2M	128	UW17-	1 РЕД КЛЕМОРЕДИ PA 2x6 mm ² 12P	158
OS26-	ПАНЕЛ SOFT 3x2M	128	UW29-	2 РЕДА КЛЕМОРЕДИ PP 1,0-4,0 mm ² 12P	158
OS28-	ПАНЕЛ SOFT 4x2M	128	UW30-	2 РЕДА КЛЕМОРЕДИ PP 1,5-6,0 mm ² 12P	158
OS30-	ПАНЕЛ SOFT 3M	129	UW31-	2 РЕДА КЛЕМОРЕДИ PP 2,5-10 mm ² 12P	158
OS40-	ПАНЕЛ SOFT 4M	129	UW32-	2 РЕДА КЛЕМОРЕДИ PP 4,0-16 mm ² 12P	158
OS70-	ПАНЕЛ SOFT 7M	129	UW25-	2 РЕДА КЛЕМОРЕДИ PA 1,0-4,0 mm ² 12P	159
OS72-	ПАНЕЛ SOFT 2x7M	129	UW26-	2 РЕДА КЛЕМОРЕДИ PA 1,5-6,0 mm ² 12P	159
OS10-	ПАНЕЛ SOFT 1/2M	129	UW27-	2 РЕДА КЛЕМОРЕДИ PA 2,5-10 mm ² 12P	159
OS13-	ПАНЕЛ SOFT 1/3M	129	UW28-	2 РЕДА КЛЕМОРЕДИ PA 4,0-16 mm ² 12P	159
OS23-	ПАНЕЛ SOFT 2/3M	129	UW40-	СЪЕДИНИТЕЛИ С ВКАРВАНЕ НА ПРОВОДНИЦИТЕ PA 1,5 mm ² 3P	159
МОНТАЖНИ РАМКИ NM			UW41-	СЪЕДИНИТЕЛИ С ВКАРВАНЕ НА ПРОВОДНИЦИТЕ PA 1,5 mm ² 5P	159
NM20	МОНТАЖНА РАМКА С КРАЧЕТА 2M	134	UW42-	СЪЕДИНИТЕЛИ С ВКАРВАНЕ НА ПРОВОДНИЦИТЕ PA 1,5 mm ² 8P	159
NM21	МОНТАЖНА РАМКА БЕЗ ВИНТОВЕ 2M	134	UW45-	СЪЕДИНИТЕЛИ С ВКАРВАНЕ НА ПРОВОДНИЦИТЕ PA 2,5 mm ² 3P	159
NM24	МЕТАЛНА МОНТАЖНА РАМКА С КРАЧЕТА 2M	134	UW46-	СЪЕДИНИТЕЛИ С ВКАРВАНЕ НА ПРОВОДНИЦИТЕ PA 2,5 mm ² 4P	159
NM25	МЕТАЛНА МОНТАЖНА РАМКА БЕЗ ВИНТОВЕ 2M	134	UW47-	СЪЕДИНИТЕЛИ С ВКАРВАНЕ НА ПРОВОДНИЦИТЕ PA 2,5 mm ² 5P	159
NM30	МЕТАЛНА МОНТАЖНА РАМКА С ВИНТОВЕ 3M	135	UW50-	СЪЕДИНИТЕЛИ С ВКАРВАНЕ НА ПРОВОДНИЦИТЕ PA 2,5 mm ² 2/1P	159
NM40	МЕТАЛНА МОНТАЖНА РАМКА С ВИНТОВЕ 4M	135			
NM70	МЕТАЛНА МОНТАЖНА РАМКА С ВИНТОВЕ 7M	135			
NM72	МЕТАЛНА МОНТАЖНА РАМКА С ВИНТОВЕ 2x7M	135			
NM10	МОНТАЖНА РАМКА С КРАЧЕТА 1/2M	136			
NM11	МОНТАЖНА РАМКА БЕЗ ВИНТОВЕ 1/2M	136			
NM23	МОНТАЖНА РАМКА С КРАЧЕТА 2/3M	136			
NM32	МЕТАЛНА МОНТАЖНА РАМКА С ВИНТОВЕ 2/3M	136			

разпределение

ekoportik

код	описание на продукта	страница
КОНЗОЛИ CUVO IP20 AC		
AC11-	КОНЗОЛА NO CUVO СЪС ЗАДЕН КАПАК IP20 1M	162
AC21-	КОНЗОЛА NO CUVO СЪС ЗАДЕН КАПАК IP20 2M	162
AC41-	КОНЗОЛА NO CUVO СЪС ЗАДЕН КАПАК IP20 4M	162
AC61-	КОНЗОЛА NO CUVO СЪС ЗАДЕН КАПАК IP20 6M	162
КОНЗОЛИ CUVO IP55 AQ		
AQ20-	КОНЗОЛА NO CUVO IP55 2M	163
AQ22-	КОНЗОЛА NO CUVO IP55 2x2M	163
AQ30-	КОНЗОЛА NO CUVO IP55 3M	163
AQ21-	КУТИЯ PO CUVO IP55 2M	164
AQ31-	КОНЗОЛА PO CUVO IP55 3M	164
СИСТЕМА ЗА КАНАЛ ЗА КАБЕЛИ МА		
RT10	АДАПТЕР МА 162	165
RT12-	ПАНЕЛ МА 92 2/3M	165
RT14-	ПАНЕЛ МА 162 4M	165
RT17-	ПАНЕЛ МА 162 7M	165
RT20-	ОСНОВА ЗА КАНАЛ МА 130x65	166
RT21-	ОСНОВА ЗА КАНАЛ МА 165x65	166
RT25	ПРЕДЕН КАПАК МА 92	166
RT30	КАБЕЛНА СКАРА МА 43	166
RT31	КАБЕЛНА СКАРА МА 43 AL	166
RT32	КАБЕЛНА СКАРА МА 43 AL ДВОЙНА	166
RT35-	КРАЕН ЕЛЕМЕНТ МА 130x65	167
RT36-	КРАЕН ЕЛЕМЕНТ МА 165x65	167
RT38	КОМПЛЕКТ СЪЕДИНИТЕЛЕН ЕЛЕМЕНТ МА 65	167
RT40-	УНИВЕРСАЛЕН ЪГЛОВ ЕЛЕМЕНТ МА 130x65	167
RT41-	УНИВЕРСАЛЕН ЪГЛОВ ЕЛЕМЕНТ МА 165x65	167
RT42	ЗАЗЕМИТЕЛЕН ЕЛЕМЕНТ МА 2x A6.3	167
RT43-	ЪКОЛЯНО МА 130x65	168
RT44-	ЪКОЛЯНО МА 165x65	168
RT45-	Т-КОЛЯНО МА 130x65	168
RT46-	Т-КОЛЯНО МА 165x65	168
RT50-	ЕДИНИЧНА ЗАКРЕПВАЩА ПЛАСТИНА МА 130x65	169
RT51-	ДВОЙНА ЗАКРЕПВАЩА ПЛАСТИНА МА 130x65	169
RT52-	СЕРВИЗНА КОЛОНА МА 130x65x500	169
RT53-	ДВОЙНА СЕРВИЗНА КОЛОНА МА 130x65x500	169
ПОДОВИ КОНЗОЛИ MT		
RV30	ПОДОВА КОНЗОЛА MT 7 H=53 mm	171
RV40	ПОДОВА КОНЗОЛА MT 7 H=88 mm	171
RV31	ПОДОВА КОНЗОЛА С ФЛАНЕЦ MT 7 H=53 mm	171
RV41	ПОДОВА КОНЗОЛА С ФЛАНЕЦ MT 7 H=88 mm	171
RV33	ПОДОВА КОНЗОЛА MT 14 H=53 mm	171
RV43	ПОДОВА КОНЗОЛА MT 14 H=88 mm	171
RV34	ПОДОВА КОНЗОЛА С ФЛАНЕЦ MT 14 H=53mm	172
RV44	ПОДОВА КОНЗОЛА С ФЛАНЕЦ MT 14 H=88 mm	172
RV36	ПОДОВА КОНЗОЛА MT 21 H=53 mm	172
RV46	ПОДОВА КОНЗОЛА MT 21 H=88mm	172
RV37	ПОДОВА КОНЗОЛА С ФЛАНЕЦ MT 21 H=53mm	172
RV47	ПОДОВА КОНЗОЛА С ФЛАНЕЦ MT 21 H=88 mm	172
РАЗПРЕДЕЛИТЕЛНИ ТАБЛА МО		
RB10	АДАПТЕР ЗА DIN РЕЛСА 35 mm 1M	173
RB11	АДАПТЕР ЗА DIN РЕЛСА 35 mm 2M	173
RB20	РАЗПРЕДЕЛИТЕЛНА КУТИЯ МО 12+2	174
RB21	РАЗПРЕДЕЛИТЕЛНА КУТИЯ МО 24+4	174
RB22	РАЗПРЕДЕЛИТЕЛНА КУТИЯ МО 36+6	174
RB23	РАЗПРЕДЕЛИТЕЛНА КУТИЯ МО 48+8	174

код	описание на продукта	страница
КЛЮЧОВЕ SE		
SE10	КЛЮЧ 1WAY 10AX 250V~	188
SE11	БУТОН 1WAY 10A 250V~	188
SE22	КЛЮЧ 2POLE 16AX 250V~	188
SE50	КЛЮЧ 2GANG-1WAY 10AX 250V~	188
SE51	БУТОН 2GANG-1WAY 10A 250V~	189
SE52	КЛЮЧ ЗА ЩОРИ 10AX 250V~	189
SE53	БУТОН ЗА ЩОРИ 10A 250V~	189
SE60	КЛЮЧ 2WAY 10AX 250V~	189
SE63	ДВОЕН КЛЮЧ 2WAY 10AX 250V~	189
SE70	КРЪСТАТ КЛЮЧ 10AX 250V~	189
SE10-	КЛЮЧ 1WAY 10AX 250V~	190
SE10-IN	КЛЮЧ 1WAY 10AX 250V~ IN	190
SE11-	БУТОН 1WAY 10A 250V~	190
SE11-TI50	БУТОН 1WAY 10A 250V~ TI 50	190
SE11-TI51	БУТОН 1WAY 10A 250V~ TI 51	190
SE11-IL	БУТОН 1WAY 10A 250V~ IL	190
SE22-IN03	КЛЮЧ 2POLE 16AX 250V~ IN 03	190
SE50-	КЛЮЧ 2GANG-1WAY 10AX 250V~	191
SE51-	БУТОН 2GANG-1WAY 10A 250V~	191
SE52-NT09	КЛЮЧ ЗА ЩОРИ 10AX 250V~ NT 09	191
SE53-NT09	БУТОН ЗА ЩОРИ 10A 250V~ NT 09	191
SE60-	КЛЮЧ 2WAY 10AX 250V~	191
SE63-	ДВОЕН КЛЮЧ 2WAY 10AX 250V~	191
SE70-	КРЪСТАТ КЛЮЧ 10AX 250V~	191
БУТОНИ TE		
TE10-	БУТОН 1GANG	192
TE10-IN	БУТОН С ИНДИКАТОР	192
TE13-IL	БУТОН С ПАНЕЛ С НАДПИС IL	192
TE11-	БУТОН 2GANG	192
ОСВЕТЛЕНИЕ IA		
IA10-	НЕОНОВА ЛАМПА 230 V~ 0,34 W	193
IA20-	СВЕТОДИОДНА ЛАМПА 230V ~ AC/DC 0,4W	193
IA21-	СВЕТОДИОДНА ЛАМПА 24 V AC/DC 0,2W	193
IA22-	СВЕТОДИОДНА ЛАМПА 12 V AC/DC 0,1W	193
КОНТАКТИ VE		
VE10-XO	КОНТАКТ ШУКО 2P+E 16A 250V~ XO	196
VE11-XO	КОНТАКТ ШУКО+КАПАК 2P+E 16A 250V~ XO	196
VE12-XO	КОНТАКТ ШУКО 2P+E 16A 250V~ BV XO	196
VE13-XO	КОНТАКТ ШУКО+КАПАК 2P+E 16A 250V~ BV XO	196
VE10-	КОНТАКТ ШУКО 2P+E 16A 250V~	196
VE11-	КОНТАКТ ШУКО+КАПАК 2P+E 16A 250V~	196
VE12-	КОНТАКТ ШУКО 2P+E 16A 250V~ BV	196
VE13-	КОНТАКТ ШУКО+КАПАК 2P+E 16A 250V~ BV	196
VE40-XO	КОНТАКТ ФРЕНСКИ 2P+E 16A 250V~ XO	197
VE41-XO	КОНТАКТ ФРЕНСКИ+КАПАК 2P+E 16A 250V~ XO	197
VE42-XO	КОНТАКТ ФРЕНСКИ 2P+E 16A 250V~ BV XO	197
VE43-XO	КОНТАКТ ФРЕНСКИ+КАПАК 2P+E 16A 250V~ BV XO	197
VE40-	КОНТАКТ ФРЕНСКИ 2P+E 16A 250V~	197
VE41-	КОНТАКТ ФРЕНСКИ+КАПАК 2P+E 16A 250V~	197
VE42-	КОНТАКТ ФРЕНСКИ 2P+E 16A 250V~ BV	197
VE43-	КОНТАКТ ФРЕНСКИ+КАПАК 2P+E 16A 250V~ BV	197
VE16-	ДВОЕН КОНТАКТ ШУКО 2P+E 16A 250V~	198
VE46-	ДВОЕН КОНТАКТ ФРЕНСКИ 2P+E 16A 250V~	198
VE30-	КОНТАКТ 2P 16A 250V~	198
КОМУНИКАЦИИ KE		
KE11	КОНЕКТОР ЗА ТВ-РАДИО КРАЕН 1 dB	199
KE12	КОНЕКТОР ЗА ТВ-РАДИО ПРЕХОДЕН 10 dB	199
KE16	КОНЕКТОР ЗА САТЕЛИТНА ТВ-ТВ-РАДИО КРАЕН 3 dB	199
KE36	КОНЕКТОР TEL KS RJ11 6/4	199
KE37	КОНЕКТОР CAT5e KS RJ45 8/8	200
KE40	КОНЕКТОР CAT6s KS RJ45 8/8 SLIM	200
KE38	ДВОЕН КОНЕКТОР TEL KS 2x RJ11 6/4	200
KE39	ДВОЕН КОНЕКТОР CAT5e KS 2x RJ45 8/8	200
KE41	ДВОЕН КОНЕКТОР CAT6s KS 2x RJ45 8/8 SLIM	200
KE45	ЕДИНИЧЕН АДАПТЕР KS	200
KE46	ДВОЕН АДАПТЕР KS	201
KE47	ДВОЕН АДАПТЕР PD	201
KE10-	КОНЕКТОР ЗА ТВ ОСНОВЕН 0 dB	202
KE11-	КОНЕКТОР ЗА ТВ-РАДИО КРАЕН 1 dB	202
KE12-	КОНЕКТОР ЗА ТВ-РАДИО ПРЕХОДЕН 10 dB	202
KE16-	КОНЕКТОР ЗА САТЕЛИТНА ТВ-ТВ-РАДИО КРАЕН 3 dB	202
KE22-	КОНЕКТОР ЗА АУДИОСИГНАЛИ 2xRCA	202
KE23-	КОНЕКТОР ЗА ВИСОКОГОВОРИТЕЛИ	202
KE36-	КОНЕКТОР TEL KS RJ11 6/4	202
KE37-	КОНЕКТОР CAT5e KS RJ45 8/8	203
KE40-	КОНЕКТОР CAT6s KS RJ45 8/8 SLIM	203
KE38-	ДВОЕН КОНЕКТОР TEL KS 2x RJ11 6/4	203
KE39-	ДВОЕН КОНЕКТОР CAT5e KS 2x RJ45 8/8	203
KE41-	ДВОЕН КОНЕКТОР CAT6s KS 2x RJ45 8/8 SLIM	203
KE35-	КОНЕКТОР TEL LT RJ11 6/4	203

код	описание на продукта	страница
КАПАЦИ РЕ		
PE10-	ПАНЕЛ ЗА ТВ-РАДИО 2P/3P	204
PE20-	ЕДИНИЧЕН ПАНЕЛ KS	204
PE21-	ДВОЕН ПАНЕЛ KS	204
PE30-	ПАНЕЛ TAE/TDO	204
ЕЛЕКТРОНИКА ЕЕ		
EE15	ДИМЕР, ВЪРТЯЩ ТИП ДВУПОСОЧЕН RL 400 W	205
EE16	ДИМЕР, ВЪРТЯЩ ТИП ДВУПОСОЧЕН RLC 400 W	205
EE19	ДИМЕР, ВЪРТЯЩ ТИП ДВУПОСОЧЕН RLC 100 W	206
EE32	IR КЛЮЧ 5 A 230V~	206
EE67	USB ЗАХРАНВАЩ БЛОК 5V 2,4A	206
EE15-	ДИМЕР, ВЪРТЯЩ ТИП ДВУПОСОЧЕН RL 400 W	207
EE16-	ДИМЕР, ВЪРТЯЩ ТИП ДВУПОСОЧЕН RLC 400 W	207
EE19-	ДИМЕР, ВЪРТЯЩ ТИП ДВУПОСОЧЕН RLC 100 W	207
EE32-	КЛЮЧ IR 5A 230V~	207
EE67-	USB ЗАХРАНВАЩ БЛОК 5V 2,4A	208
ПАНЕЛИ ЗА ЕЛЕКТРОНИКА РЕ		
PE41-	ПАНЕЛ ЗА ДИМЕР Ø6	210
PE32-	ПАНЕЛ IR КЛЮЧ	210
PE67-	КАПАК ЗА USB ЗАХРАНВАЩ БЛОК	210
ПРИНАДЛЕЖНОСТИ АЕ		
AE10-	КАПАЧЕ	211
AE20-	СЪЕДИНИТЕЛНА КОНЗОЛА 5POLE 3P+N+E 5x4 mm ²	211
AE30-	КОНЗОЛА ЗА ВЪНШЕН МОНТАЖ 1	211
AE31-	КУТИЯ ЗА МОНТАЖ НА ПОВЪРХНОСТИ ЗА ДВОЕН КОНТАКТ	211
AE50-	СТЕННА ЗАЩИТА	212
AE51-	ЗАЩИТА ЗА ДЕЦА KS	212
РАМКИ ОЕ		
OE10-	РАМКА ЕКОНОМИК 207	213
OE20-	РАМКА ЕКОНОМИК 2 ХОРИЗОНТАЛНА	213
OE21-	РАМКА ЕКОНОМИК 2 ВЕРТИКАЛНА	213
OE30-	РАМКА ЕКОНОМИК 3 ХОРИЗОНТАЛНА	213
OE31-	РАМКА ЕКОНОМИК 3 ВЕРТИКАЛНА	214
OE40-	РАМКА ЕКОНОМИК 4 ХОРИЗОНТАЛНА	214
OE41-	РАМКА ЕКОНОМИК 4 ВЕРТИКАЛНА	214
OE50-	РАМКА ЕКОНОМИК 5 ХОРИЗОНТАЛНА	214
OE90-	ЦВЕТНИ ДЕКОРАТИВНИ РАМКИ	215

fontana

код	описание на продукта	страница
КЛЮЧОВЕ SF		
SF10-	КЛЮЧ 1WAY IP44 10AX 250V~	218
SF10-TI	КЛЮЧ 1WAY IP44 10AX 250V~ TI	218
SF11-TI	БУТОН 1WAY IP44 10A 250V~ TI	218
SF20-	КЛЮЧ 2POLE IP44 10AX 250V~	218
SF50-	КЛЮЧ 2GANG-1WAY IP44 10AX 250V~	219
SF51-	БУТОН 2GANG-1WAY IP44 10A 250V~	219
SF60-	КЛЮЧ 2WAY IP44 10AX 250V~	219
SF60-TI	КЛЮЧ 2WAY IP44 10AX 250V~ TI	219
SF63-	ДВОЕН КЛЮЧ 2WAY 10AX 250V~	219
SF70-	КРЪСТАТ КЛЮЧ IP44 10AX 250V~	219
КОНТАКТИ VF		
VF10-	КОНТАКТ ШУКО+КАПАК IP44 2P+E 16A 250V~	220
VF12-	КОНТАКТ ШУКО+КАПАК IP44 2P+E 16A 250V~ BV	220
КОМПЛЕКТИ CF		
CF10-	КОМПЛЕКТ КОНТАКТИ ШУКО ДВОЙНИ ХОРИЗОНТАЛНИ IP44 2x2P+E 16A 250V~	221
CF11-	КОМПЛЕКТ КОНТАКТИ ШУКО ДВОЙНИ ВЕРТИКАЛНИ IP44 2x2P+E 16A 250V~	221
CF12-	КОМПЛЕКТ КОНТАКТИ ШУКО+КЛЮЧ 2WAY ХОРИЗОНТАЛНИ IP44 16A + 10AX 250V~	221
CF13-	КОМПЛЕКТ КОНТАКТИ ШУКО+КЛЮЧ 2WAY ВЕРТИКАЛНИ IP44 16A + 10AX 250V~	222
CF14-	КОМПЛЕКТ КОНТАКТИ ШУКО ДВОЙНИ ХОРИЗОНТАЛНИ IP44 2x 2P+E 16A 250V~ BV	222
CF15-	КОМПЛЕКТ КОНТАКТИ ШУКО ДВОЙНИ ВЕРТИКАЛНИ IP44 2x 2P+E 16A 250V~ BV	222
CF16-	КОМПЛЕКТ КОНТАКТИ ШУКО+КЛЮЧ 2WAY ХОРИЗОНТАЛНИ IP44 16A + 10AX 250V~ BV	222
CF17-	КОМПЛЕКТ КОНТАКТИ ШУКО+КЛЮЧ 2WAY ВЕРТИКАЛНИ IP44 16A + 10AX 250V~ BV	222
ПРИНАДЛЕЖНОСТИ АФ		
AF10-	РАЗПРЕДЕЛИТЕЛНА КУТИЯ IP44 RNO1	223
AF20-	РАЗПРЕДЕЛИТЕЛНА КУТИЯ IP55 NDO1	223



TEM
On | Off and everything in between

100% ELEKTRIČEN

www.tem.si

TEM
On|Off and everything in between



www

1W3-02



TEM

TEM
On/Off and everything in between

www.tem.si

NM JE-065

.tem.si

TEM
LOGIQ



On | Off and everything in between

TEM

TEM ČATEŽ d.o.o.
Čatež 13, 8212 VELIKA LOKA
SLOVENIJA
tem@tem.si
www.tem.si

T +386(0)7 348 99 00

TEM

BG

www.tem.si