

TEM

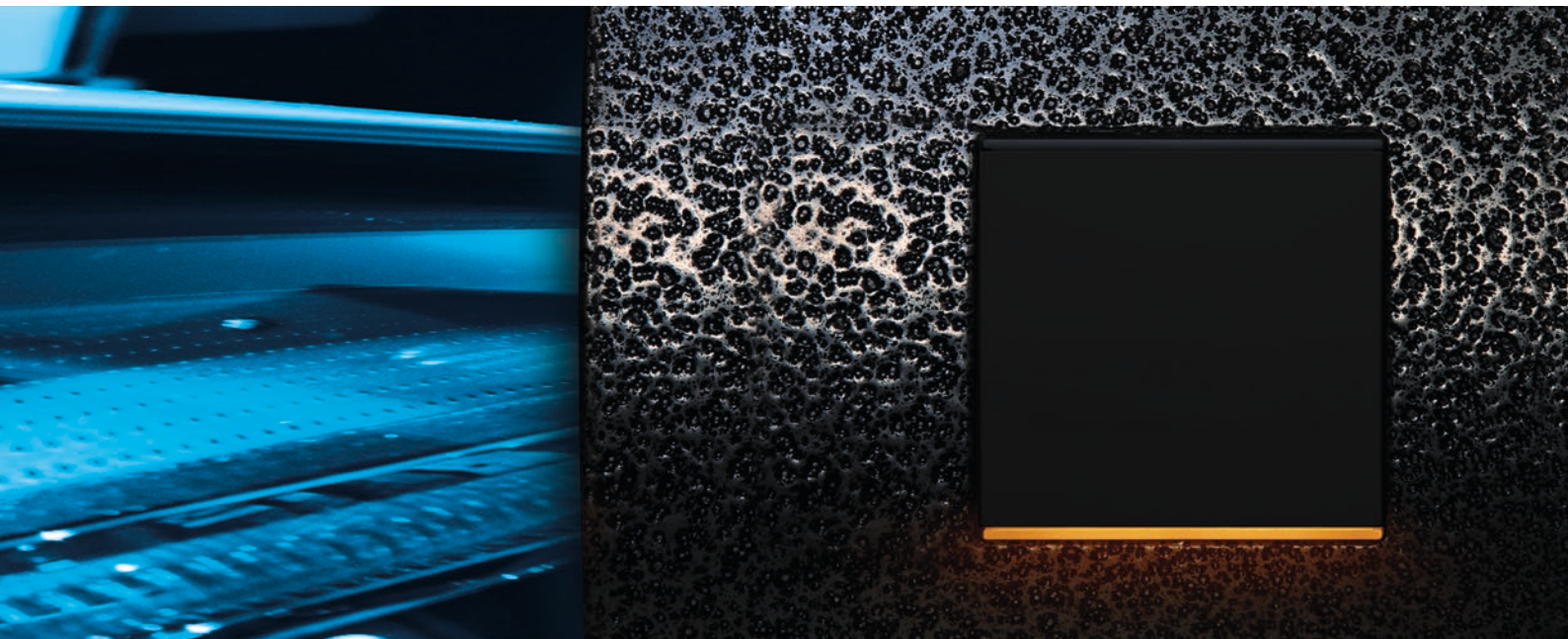

touching completeness

TEM



Dobrodošli u obitelj **MODUL**

Welcome to the **MODUL** family

Proširujemo i usavršavamo modernu obitelj Modul sklopki za sve vrste prostorija.

We are expanding and perfecting the modern Modul switch family for all types of rooms.

discovering new insights

otkrivanje novih saznanja

MODUL

Dizajnerske linije Pure, Line i Soft odražavaju moderan, sofisticiran i neovisan životni stil. U širokoj paleti boja, uzoraka i oblika možete odabrati sklopke i utičnice koje će pristajati željenoj atmosferi i ugodaju.

The Pure, Line and Soft design lines reflect a modern, sophisticated and independent lifestyle. You can choose from a wide and rich selection of colours, patterns and shapes to alter the appearance of your switches and sockets so that they fit the desired atmosphere and mood.

PURE

prirodni materijali
natural materials

drvo
metal
staklo

wood
metal
glass

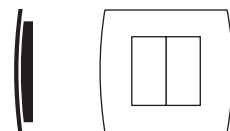

—line—



ravne linije
straight lines

—soft—



meke linije
soft lines

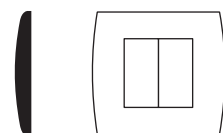
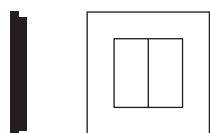

PURE



predivan život wonderful living

Iz čistoće i neokaljanosti novonastalog svijeta dolazi priča linije Pure. Dodir prirodnih motiva prošaran je sofisticiranim ukusom za linije i oblik i isprepleten nitima najnovije tehnologije.

From the cleanliness and purity of a new-born world stems the story of the Pure line. The touch of natural motifs is intertwined with a sophisticated taste for lines and form and interwoven with threads of state-of-the-art technology.



PURE

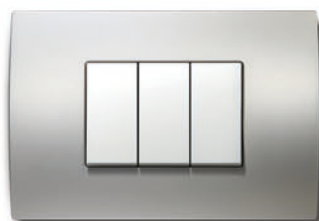
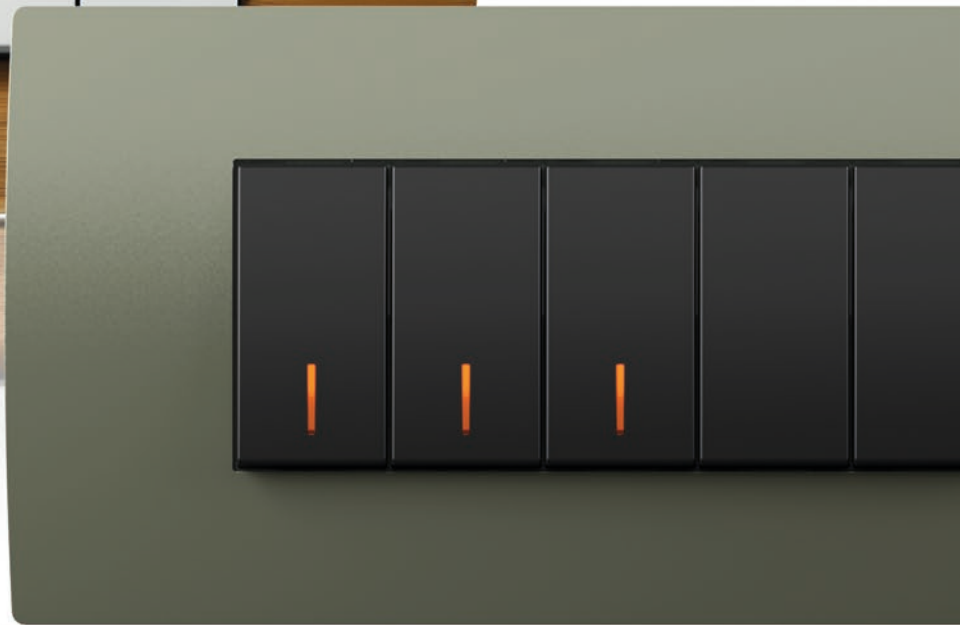



osjetiti prirodu feeling of nature

Linija Pure sklopki ističe se svojim prirodnim materijalima: metalom, drvom i staklom. Njezin jedinstveni dizajn ima posebnu draž. Upečatljiv, no ipak nenametljiv. Zrači senzualnošću, sofisticiranošću, visokim standardima te, naravno, čistoćom.

The Pure switch line is distinguished by its natural materials: metal, wood and glass. Its unique design gives it a special touch. It is striking yet unobtrusive. It radiates sensuality, sophistication, high standards and, of course, cleanliness.

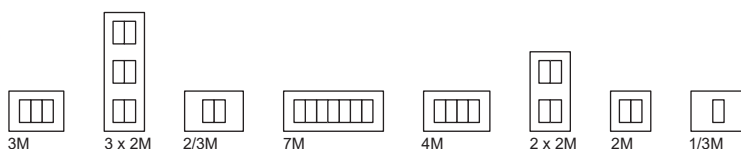

line



harmonija ravnih linija harmony of straight lines

Pripremite se za elegantno savršenstvo ravnih oblika. Isprobajte sjajne površine koje se poigravaju s modernim elementima vaše sobe. Samo za vas smo uključili smo „Soft Touch”, pretvarajući svaki dodir u jedinstveno iskustvo.

Prepare for the elegant perfection of straight shapes. Try brilliant surfaces that gently play with modern elements of your room. We have incorporated “Soft Touch” technology especially for you, turning every touch into a unique experience.



line

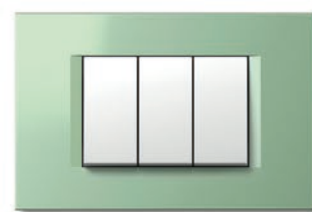
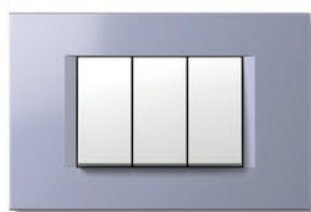
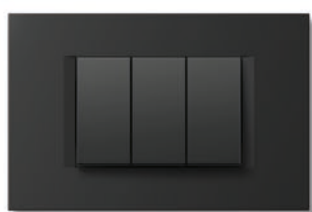
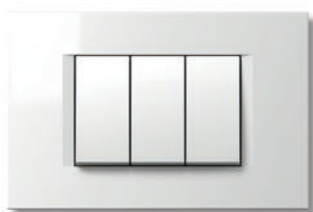
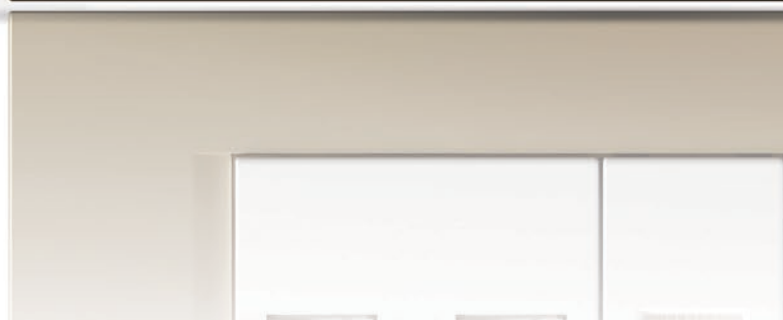
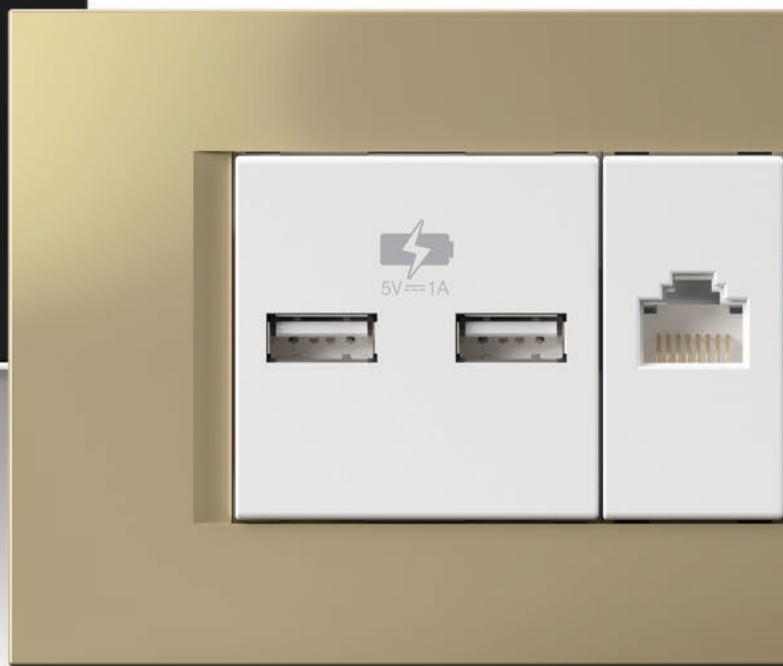

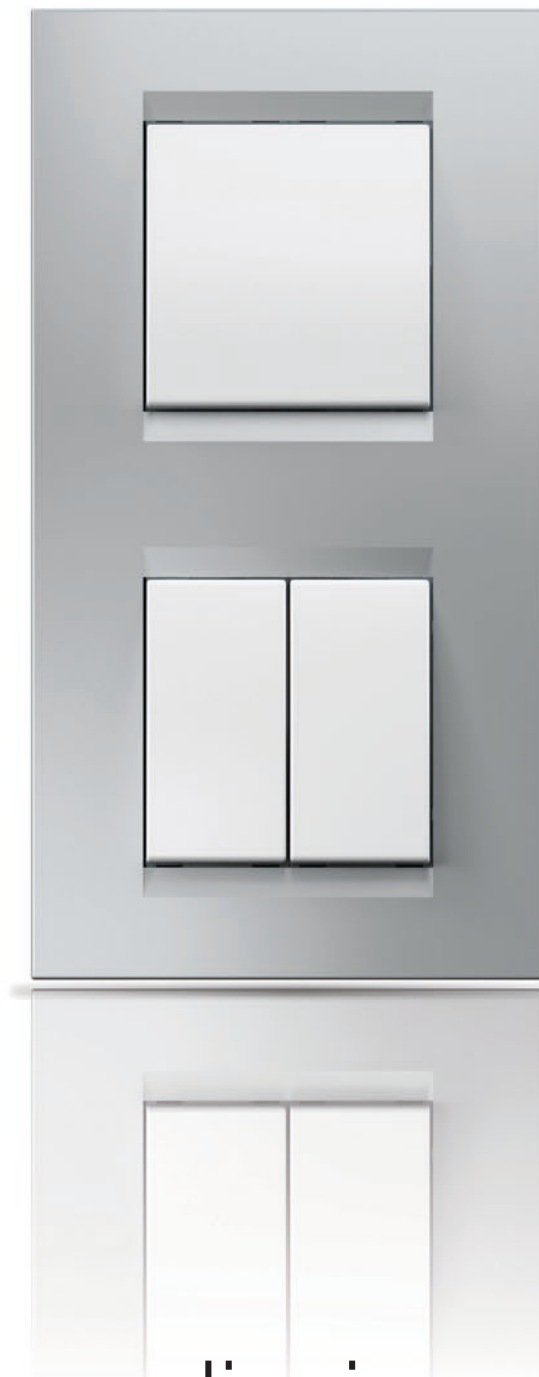
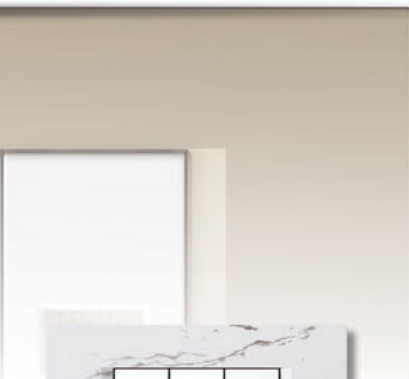

moderan dizajn modern design

Čiste, ravne linije čine svezremenski dizajn. Savršeno ravan profil i ergonomija laganog dodira daju zapanjujuće elegantan izgled iz svih kutova.

Its straight, smooth lines make for a timeless design. Its perfectly straight, sleek profile and soft-touch ergonomics give it an amazingly elegant appearance from all angles.



soft



mekoća u vašem domu

softness in your home

Neka okrugli oblici i meki prijelazi unesu mekoću u vaš dom.

Let the rounded shapes and soft transitions
bring softness into your home.



soft

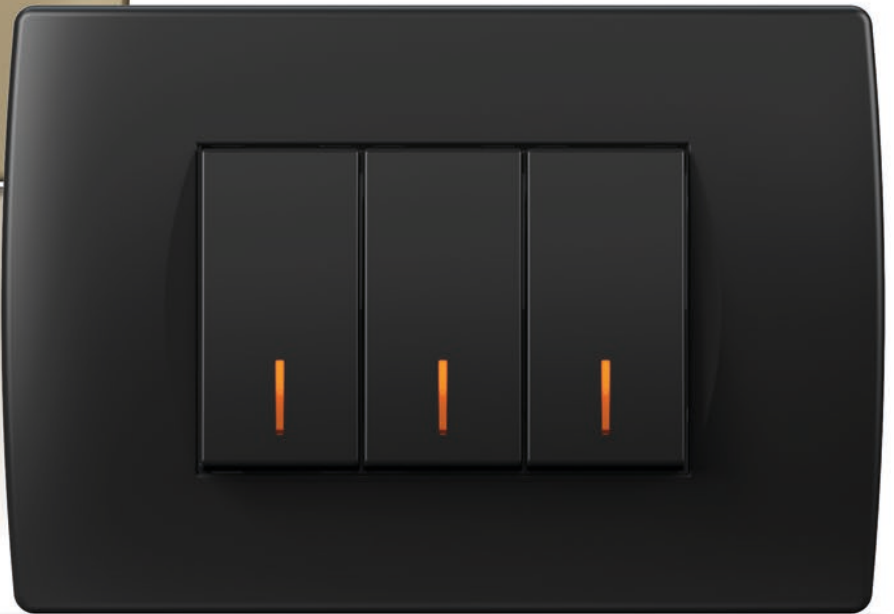



toplina doma a warm home

Savršeno meke linije zaokružene suptilnim odabirom boja i posebnim premazima za poseban dodir.

Perfectly soft shapes rounded off by a subtle selection of colours and special coatings for a special touch.

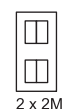
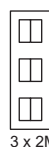
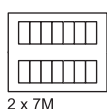

univerzalni zatamnivač

universal dimmer

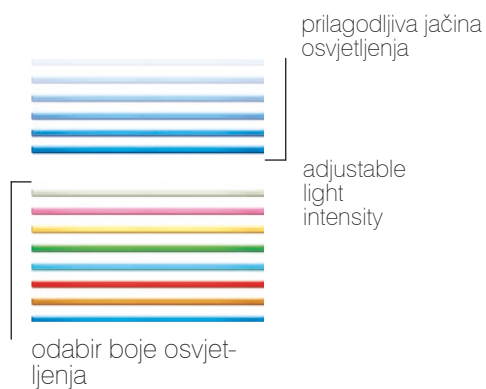
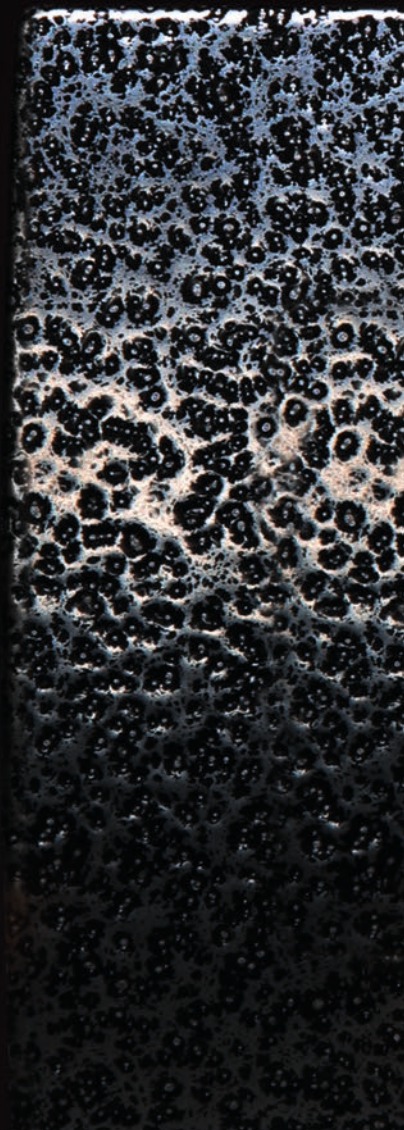

prilagodljiva jačina
osvjetljenja

adjustable
light
intensity

odabir boje osvjet-
ljenja

choosing
illumination
colour

U tami Touch postaje nježno meko ambijentalno svjetlo koje označava mjesto sklopke i nježno osvjetljava. Obilježava mjesto sklopke i nježno osvjetljava mjesto. Možete birati između osam različitih boja nježnog svjetla i prilagoditi jačinu ovisno o vašem raspoloženju.

In the dark Touch becomes a tender soft ambient light. It marks the spot of a switch and gently illuminates a place. You can choose among eight different colours of tender light and adapt its brightness according to your mood.

TOUCH®



svjetlo kakvo nije viđeno prije light as never seen before

Prigušeno svjetlo stvara mirnu, senzualnu i romantičnu atmosferu. To je osobina romantičnih mjesta i mirnih večernjih sati provedenih u domu ili na poslu. Uključivanje je meko i produženo. Ne samo da produžuje vijek trajanja žarulje, već mijenja tamu u svjetlo na sporiji i znatno ugodniji način. Touch vam omogućava zatamnivanje svjetla bilo gdje, neovisno o vrsti žarulje.

A dimmed light makes peaceful, sensual and romantic atmosphere. It is a trade mark of romantic places and quiet late evening hours spent at home or at work. Switching is soft and extended. It does not only prolong the lamp life expectancy, but also changes darkness into light in a slower and much more pleasant way. Touch enables you to dim the light anywhere, regardless of the type of lamps.





sve na jednome mjestu

everything in one place

Vaša je kuća središte vašeg života. Brojni uređaji koje koristite zahtijevaju niz konektora i utičnica. Stvorite vlastito multimedijско središte, koje će vam omogućiti povezivanje i korištenje brojnih komponenti, sve na jednom mjestu.

Your house is the centre of your life. The multitude of devices you use requires a number of connectors and sockets. Create your own multimedia centre, one that will allow you to connect and use a multiple number of different components in one place.

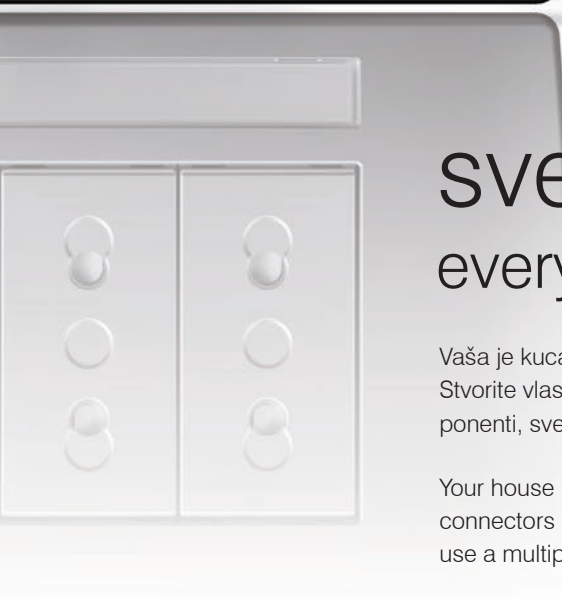



inovativna kontrola temperature

innovative temperature controller

Povećajte vlastitu udobnost kontroliranjem temperature u vašim životnim i radnim prostorijama tijekom svih godišnjih doba uz pomoć pametnog termostata. Omogućava vam upravljanje uređajima za grijanje i hlađenje, a ima i eko funkciju.

Make yourself comfortable by controlling the temperature in your living and working rooms during all seasons with a smart thermostat. It allows you to control heating and cooling devices and features an eco-function.

udobnost u vašem prostoru
comfort in your room



prikladnost korištenja

convenience of use



TOUCHLESS-bez dodira

Beskontaktna sklopka dopušta vam uživanje u modernom životnom stilu, omogućujući uključivanje i isključivanje svjetla bez potrebe za fizičkim dodirima. Ta je mogućnost vrlo korisna kada imate pune ruke ili uprljane jer možete postići željene osvjetljenje bez nepotrebnog napora.

The touchless switch allows you to enjoy a modern lifestyle, enabling the turning on and off of your lights, without the need for physical interaction. This option is very useful when you find yourself with your hands full, or dirty, as you can achieve the desired lighting without undue fuss.



moderno osvjetljenje

modern illumination





3D lampa

3D lamp

Užurbani tempo života izlaže vas konstantnom bombardiranju obiljem informacija. 3D lampe u boji pružaju elegantno rješenje za putokaze. Grafička rješenja možemo prilagoditi vašim željama.

The rapid pace of life means you are constantly being bombarded with a plenty of information. 3D colour lamp provide an elegant solution for information and direction signs. We can make graphics according to your wishes.



ARX – recite zbogom ključevima

ARX – say goodbye to keys

ARX ONE vam omogućava siguran i praktičan pristup vašem stanu, kući ili uredu. Dovoljan je samo jedan pokret prstom za otključavanje vrata. Funkcionira kao zasebna jedinica te ne zahtijeva računalnu vezu.

The ARX ONE allows you to gain access to your apartment, house or office securely and conveniently. It takes only a swipe of the finger to unlock the door. It functions as an independent unit and requires no computer connection.

poboljšana sigurnost

29

improved security



individualnost

individuality



načinite po svojem

make it your own

Budite drugačiji. Načinite sklopku po svojem ukusu. Možete odabrati između različitih boja okvira te ih za vas možemo ukrasiti prilagođenim grafičkim rješenjima ili znakovima. Odaberite boju osvjjetljenja koja odgovara ambijentu vašeg prostora.

Be different. Make a switch according to your taste. You can choose between different frame colours and we can decorate them for you with custom graphics or signs. Choose a illumination colour that suits the ambience of your room.



modularnost

modularity

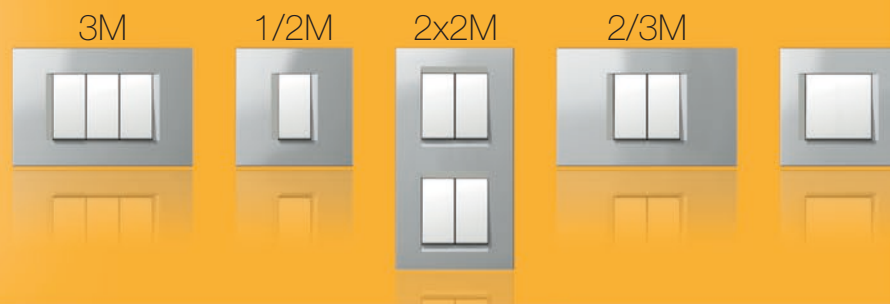

Dizajnirali smo sveobuhvatan sustav koji krase raznoliki elementi, omogućavajući vam kreiranje bilo koje konfiguracije po vašim željama. Osnovni elementi sustava su modularni te mogu biti kombinirani horizontalno ili vertikalno.

We have designed a comprehensive system that features a variety of elements, allowing you to create any configuration you wish. The basic elements of the system are modular and can be combined horizontally or vertically.



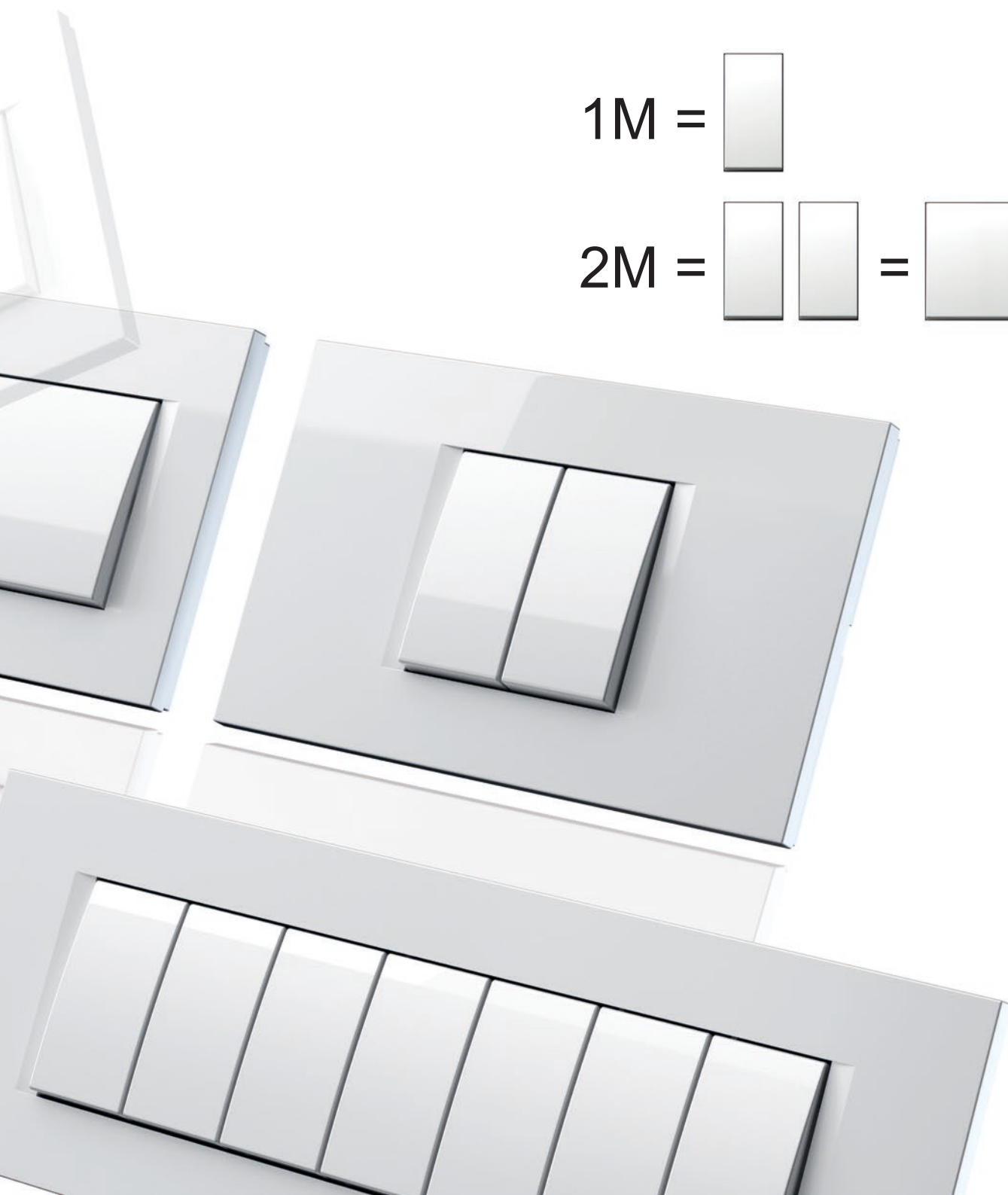
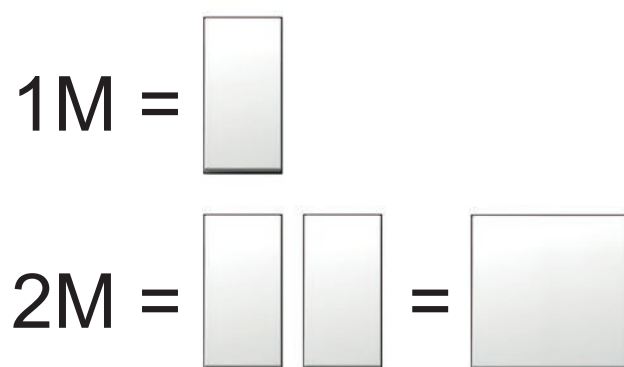
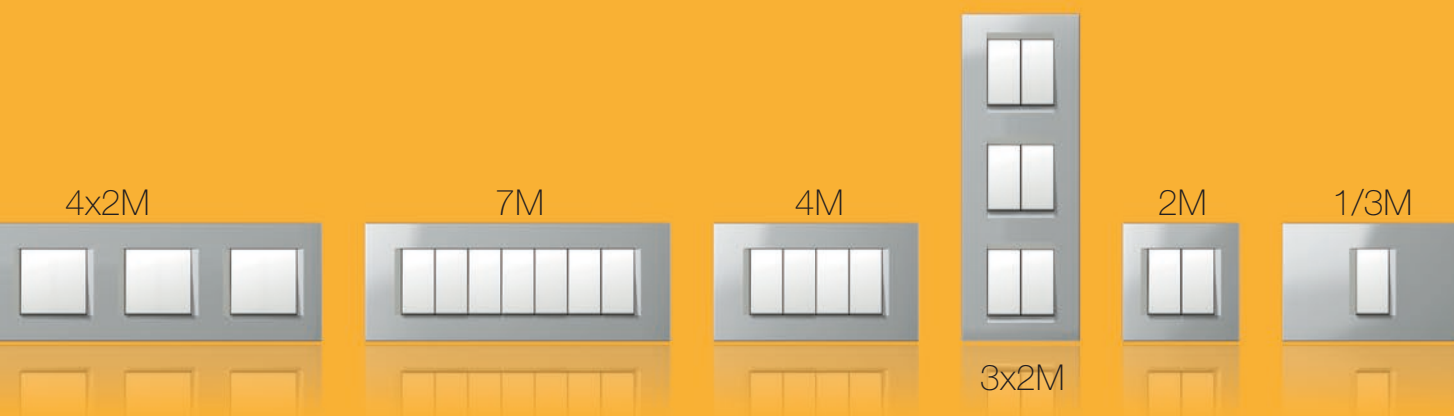

univerzalnost

universality

Sustav krasi sveobuhvatan izbor elemenata te jednostavnost ugradnje. Setovi sklopki mogu biti postavljeni na različite načine, neovisno o tome je li kutija okrugla ili pravokutna, izdvojena ili u nizu.

The system features a comprehensive selection of elements and is easy to install. Switch sets can be positioned in many different ways, regardless of whether the box is round or rectangular, individual or serial.



modulmanager.tem.si

Iskušajte „ModulManager“ alat koji će vam pomoći da sastavite onu kombinaciju koju želite.

Try out the “ModulManager” tool, which will help you put together any combination you want.

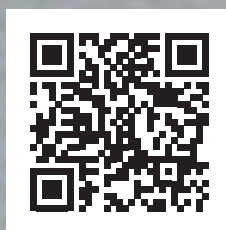

rješenja za 4 sklopke

solutions for 4 switches



MODUL MANAGER

jednostavno i brzo / easy and fast





konfigurator sklopki i utičnica

configurator of switches and sockets

Modul manager vam omogočuje potpuno i brzu izradu popisa prekidača na gradilištu ili u kućnom naslonjaču. Za vas smo pripravili jedinstveni način naručivanja koji je praktičan i brz. Omogućeno vam je kreiranje boja prekidača i oblika okvira kako biste ih prilagodili vašem prostoru ili zahtjevu kupca. Isprobajte našu aplikaciju, potreban vam je samo mobilni telefon, tablet ili računalo i <http://modulmanager.tem.si>.

The Manager Module allows you to perform a complete and quick inventory of switches from the building site itself or from the comfort of your own home. We have prepared a unique ordering method, which is both practical and quick. You can select the colours of the switches, as well as the shape of the frames, meaning you can tailor them to your space or the client's demands. Why not try us out? All you need is a smartphone, a tablet, or a computer and <http://modulmanager.tem.si>.

funkcionalnost

functionality

Modul je razvijen za one koji cijene pomno dizajniran proizvod. Sustav zauzima manje prostora jer bilo koja kombinacija funkcijskih elemenata može biti ugrađena u isti okvir. Prikladan je za nove i obnovljene građevine.

The Modul was developed for those who can appreciate a thoughtfully designed product. The system takes up less space, as any combination of function elements can be fitted inside the same cover plate. It is suitable for new, as well as renovated buildings.



Modul Soft je dostupan i s antibakterijskim rješenjem AB.

The Modul Soft is also available in an antibacterial solution AW.

dekorativni okviri
decorative cover plates

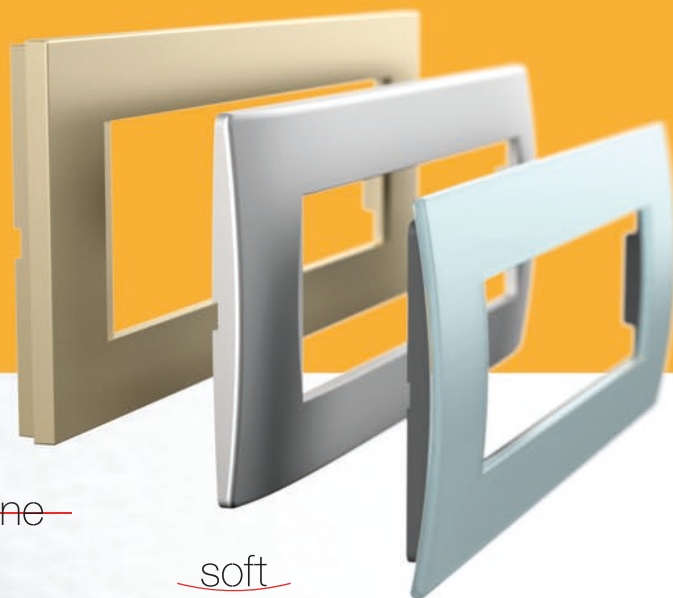

—line—

—soft—

PURE



funkcijski elementi
function elements



jednostavnost simplicity

Funkcijski elementi jednostavno se ugrađuju u nosač. Rješenje „klik-in, klik-out” koje smo za vas osmislili smanjit će vrijeme ugradnje. Kontakti spojeva lako su dostupni s prednje strane.

The function elements are easily fitted inside the mounting frame. The “klik-in, klik-out” solution we have developed for you will reduce installation time. The connection contacts are easily accessible from the front.

line
soft
PURE

klik-in, klik-out

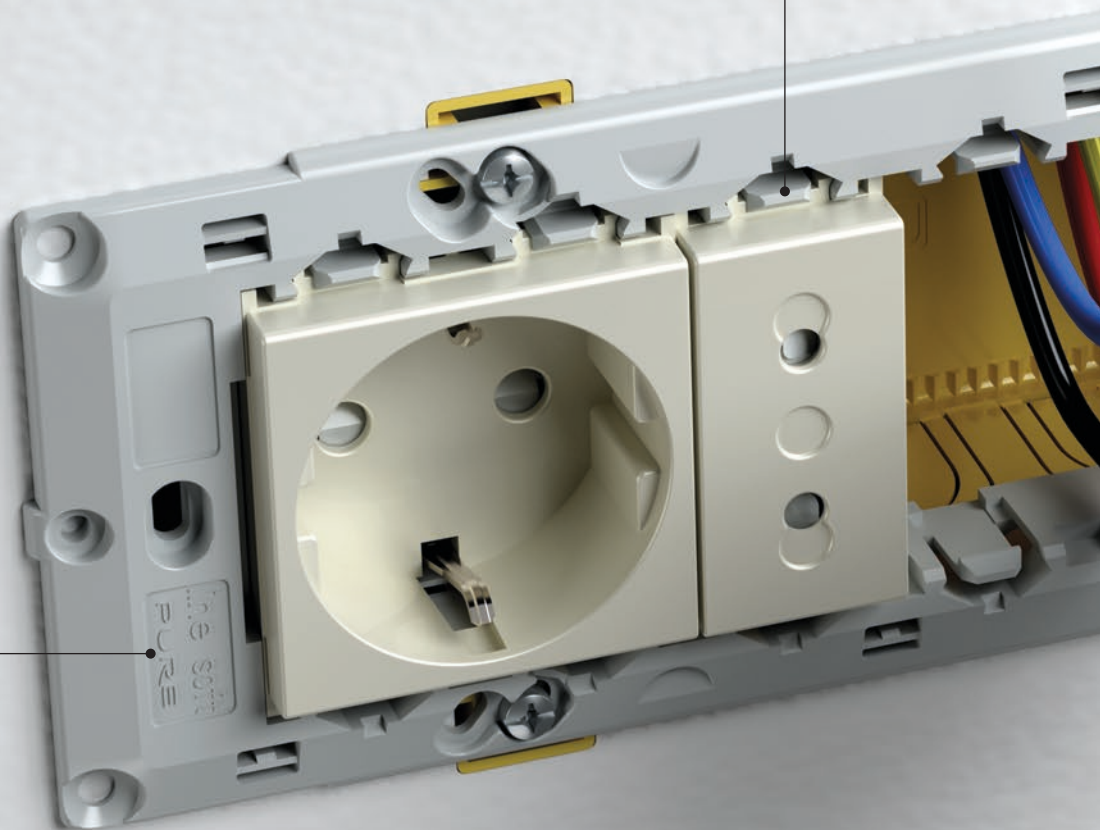

„Klik-out” – brzo i jednostavno, bez potrebe za vijcima.

“Klik-out” - simple and quick, no screws necessary.

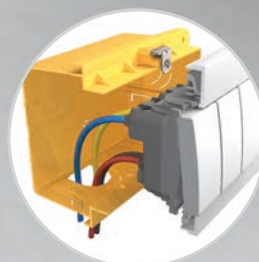

Pravokutne kutije imaju više mjesta za žice spajanja.

Rectangular boxes have more space for connection wires.

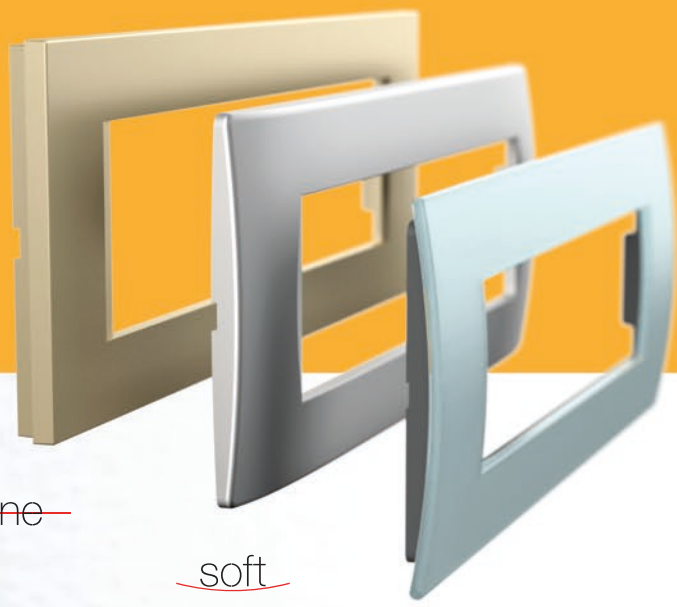
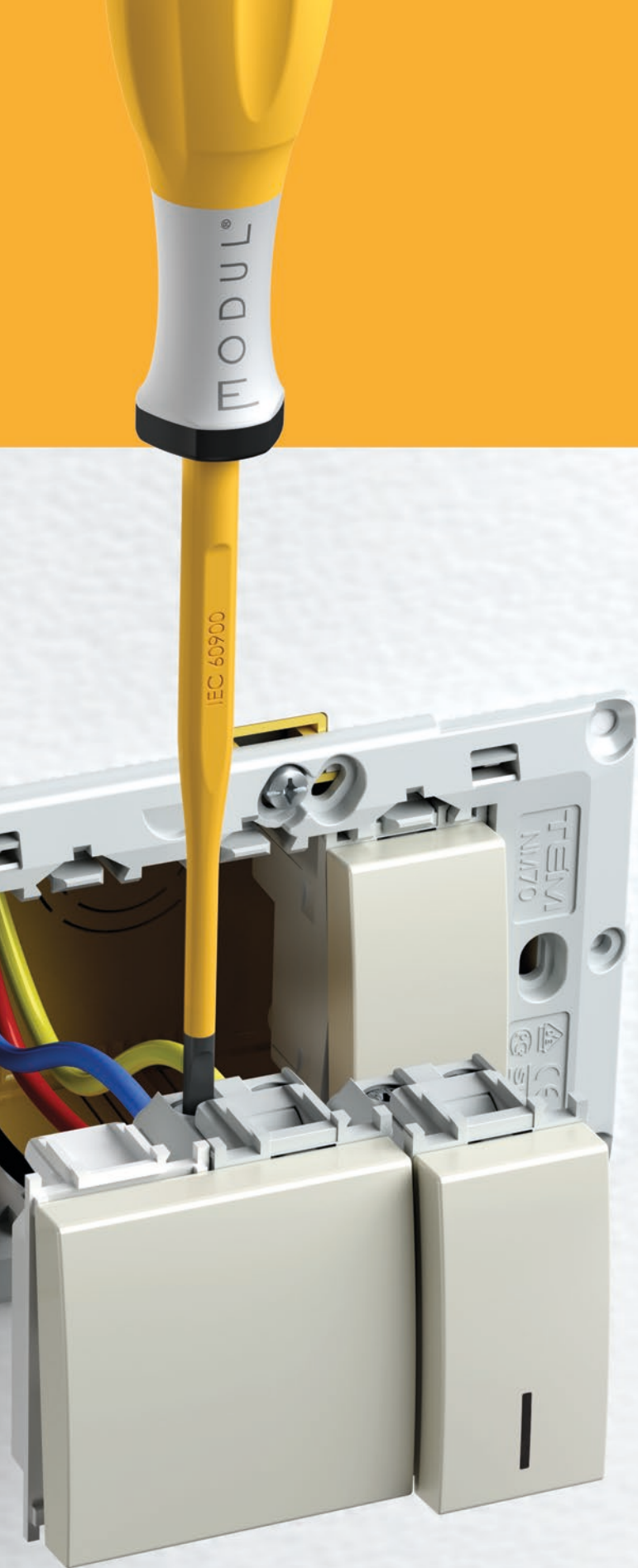

line

soft

PURE

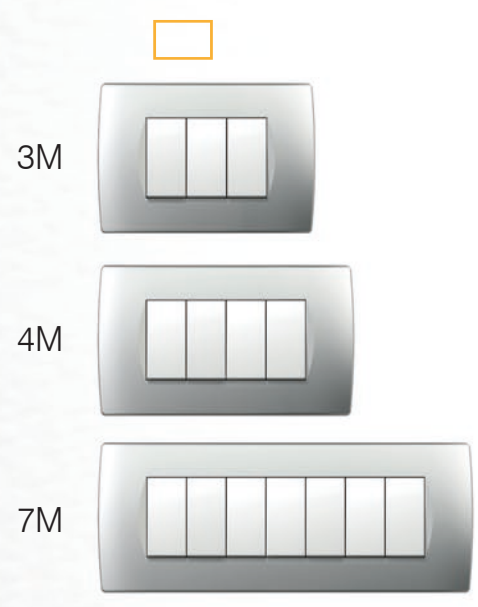

3M

4M

7M

kombiniranje

combinability

Modul pruža brojne mogućnosti, čak i s okruglim kutijama. Možete ih kombinirati horizontalno ili vertikalno, zasebno ili u grupama. Metalni ugradbeni okvir osigurava izvrsnu stabilnost, čak i s grubim korištenjem, te je prikladan za sve okvire.

The Modul enables a many possibilities even with round boxes. You can combine them horizontally or vertically, individually or in groups. The metal mounting frame ensures excellent stability even with rough use and is suitable for any decorative cover plates.

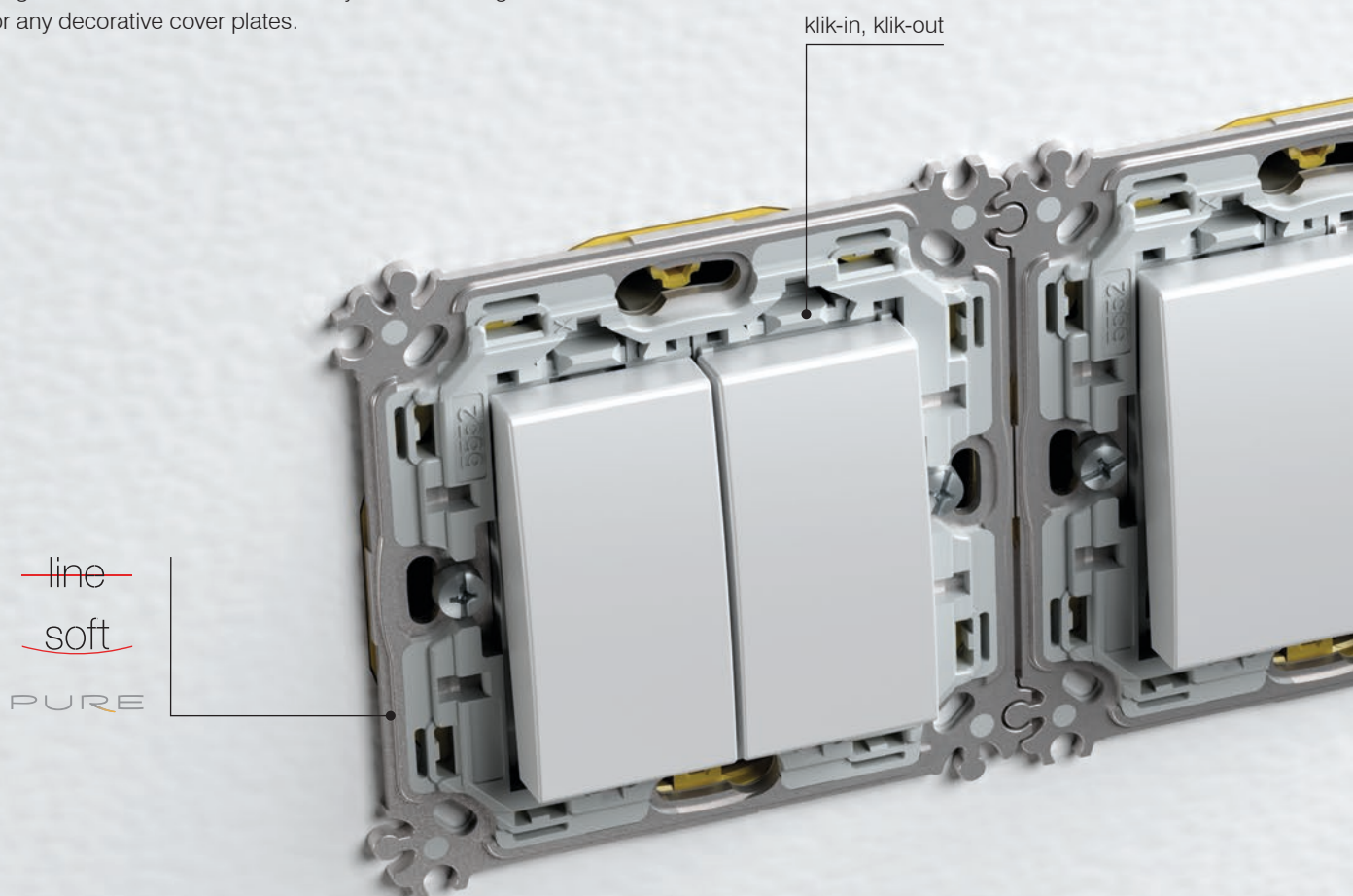

Isti okvir može biti postavljen horizontalno ili vertikalno.

The same cover plate can be positioned horizontally or vertically.

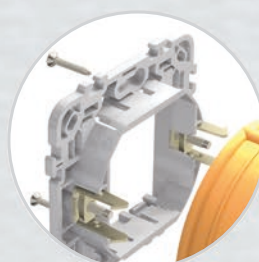

Ugradbeni okvir može biti pričvršćen vijcima ili zupčastim spojevima.

Mounting frames can be fixed with screws or claws.

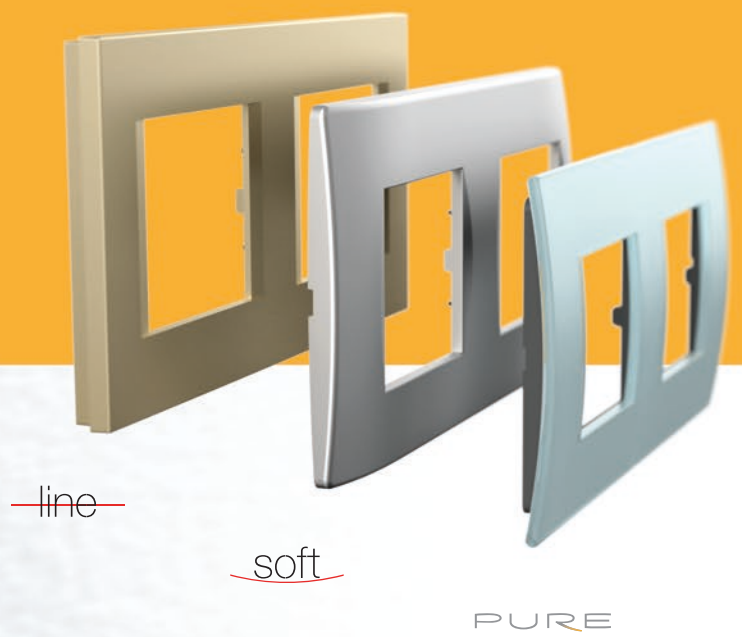

2M ugradbeni okviri lako se spajaju u grupe.

2M mounting frames are easily joined into groups.

univerzalnost

universality

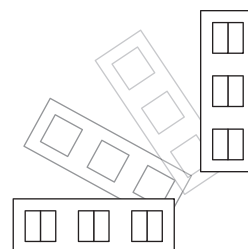
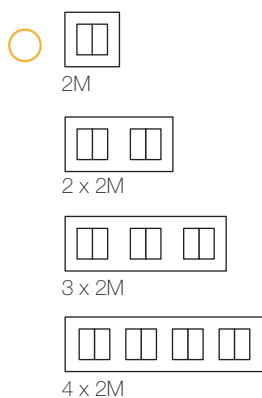
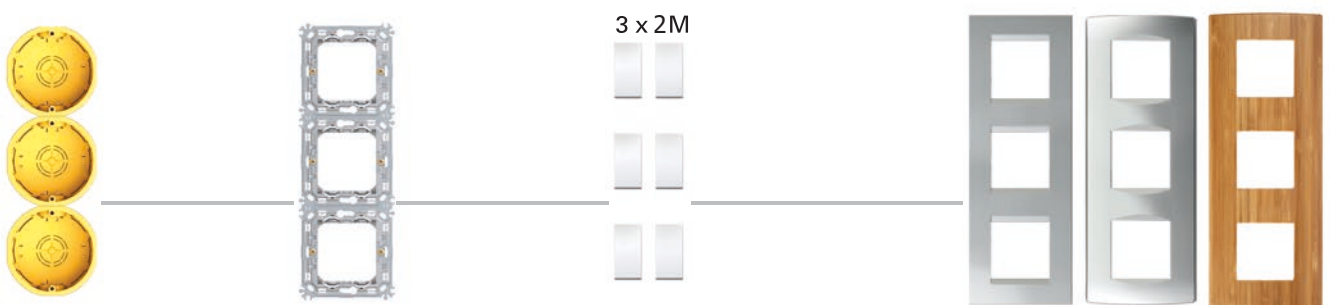
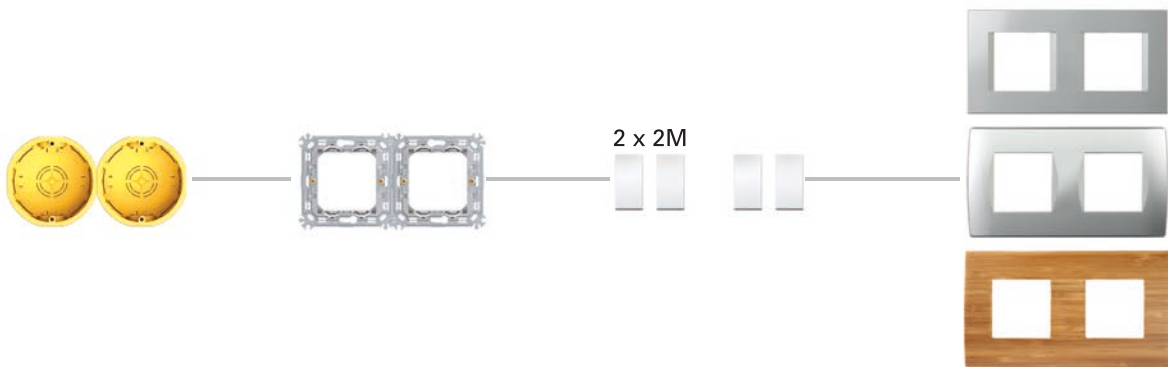
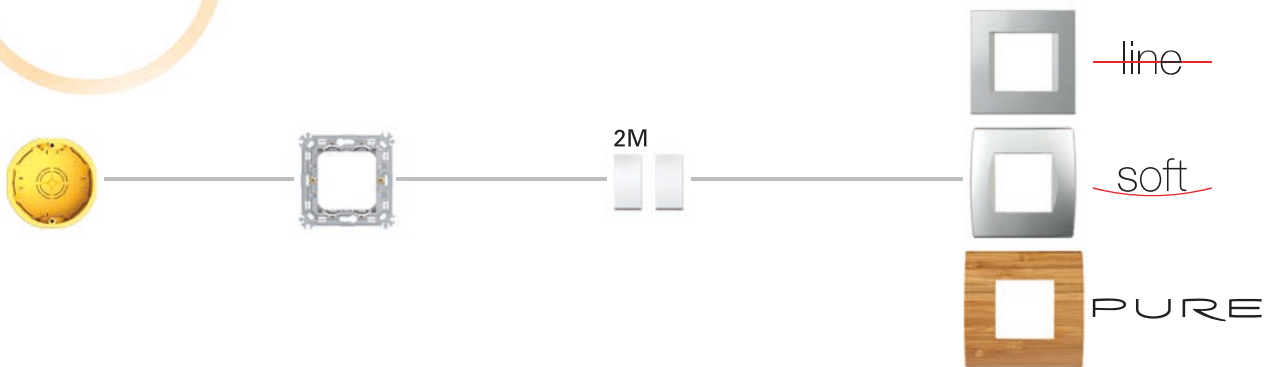

Sustav je univerzalan te se može ugraditi i u
okrugle i u pravokutne kutije.

The system is universal and can be fitted in both round and
rectangular boxes.

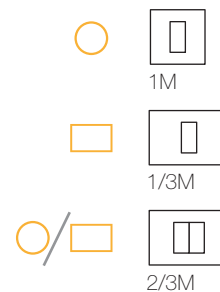
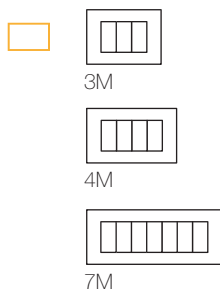
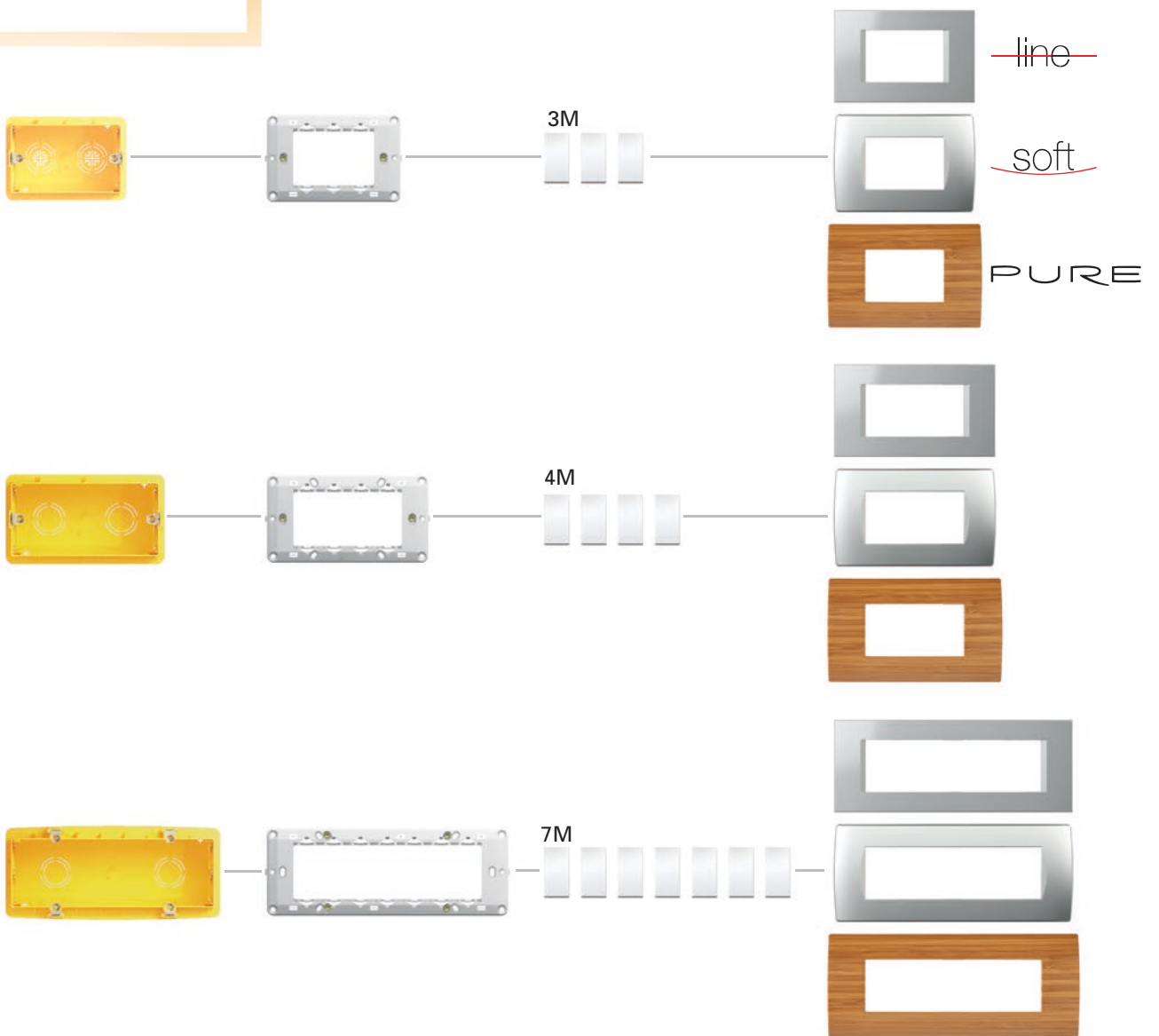

funkcijski elementi

function elements

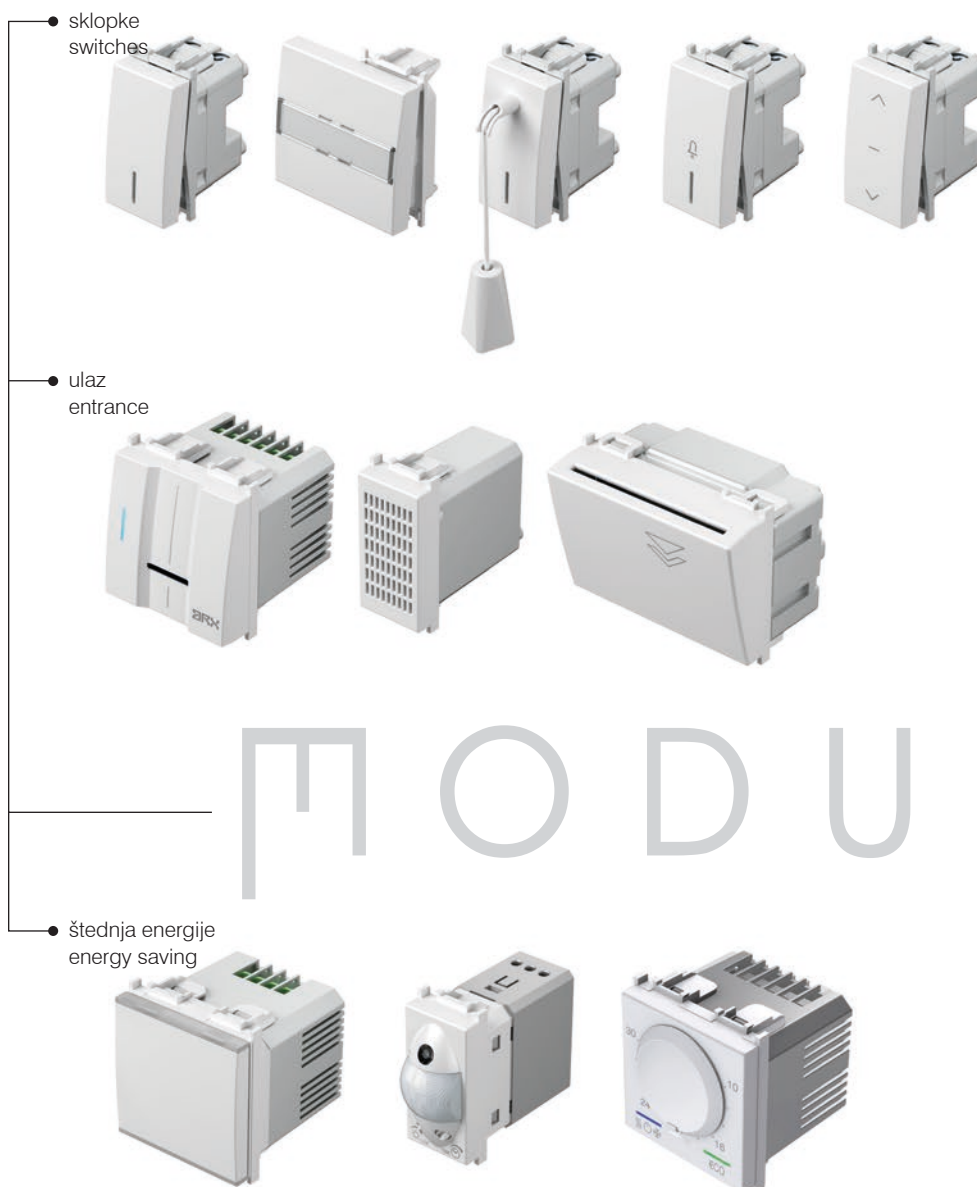

Pouzdana spajanje kod korištenja žica različitih debljina.

Reliable connection even when different size of wires are used.



Dugotrajnost sklopki te usklađenost s međunarodnim standardima.

Long-life of switches and adequacy to the international standards.

We have designed a wide selection of function element for the Modul family. You can use them to design both simple and complex installations.



• utičnice
sockets

• zabava
entertainment

• osvjetljenje
illumination



Sve su uticnice opremljene sigurnosnim sklopovima koji osiguravaju zaštitu od kontakta s naponom.
All the sockets are equipped with a safety shutters assuring the protection to live contacts.



Sklopka je vrlo pouzdana zahvaljujući srebrnim zakovicama kontakata.

The switch is highly reliable via its silver rivets contacts.

jedinstven raspon iskoristivosti

unique range of usability

Modul Soft AW
antibakterijsko rješenje
antibacterial solution



MODUL

CUBO IP20

nadžbukna kutija
surface mounted boxes



CUBO IP55

nadžbukna kutija
surface mounted boxes



IP44

podžbukna ugradnja
flush mounted



Opremate li vaš dom, ured ili radionicu? Modul je prikladan kako za stambene, tako i za radne prostore te privatne i javne zgrade. Jedinstven je po tome što sklopke i utičnice mogu biti ugrađene gdje god se za to ukaže potreba.

Are you furnishing your home, office or workshop? The Modul is suitable for living as well as working spaces and both private and public buildings. It is unique in that the switches and sockets can be fitted wherever they are needed.

Dcigla
brick**H**šuplji zid
hollow wall**B**beton
concrete

• funkcijski elementi /
function elements

sklopke / switches
utičnice / sockets
komunikacije / communications
senzori / sensors
regulatori / regulators
rasvjetna tijela / illuminations

MAparapetni kanali
trunking systems**MO**razdjelni ormarići
distribution boards**MT**podne kutije
floor boxes

podžbukna rješenja

flush mounted solutions

cigla / brick

Modul je prikladan za sve vrste zidova te se može koristiti u konvencionalnm šupljim zidovima ili betonskim konstrukcijama. Jednostavno se ugrađuje i omogućuje vam kombiniranje pravokutnih ili okruglih kutija na odgovarajućoj udaljenosti. Materijali koji se koriste usklađeni su s visokim standardima.

The Modul is suitable for all wall types and can be used in conventional, hollow wall or concrete constructions. It is easy to install and enables you to combine rectangular or round boxes at the proper distances. The materials used are compliant with high standards.



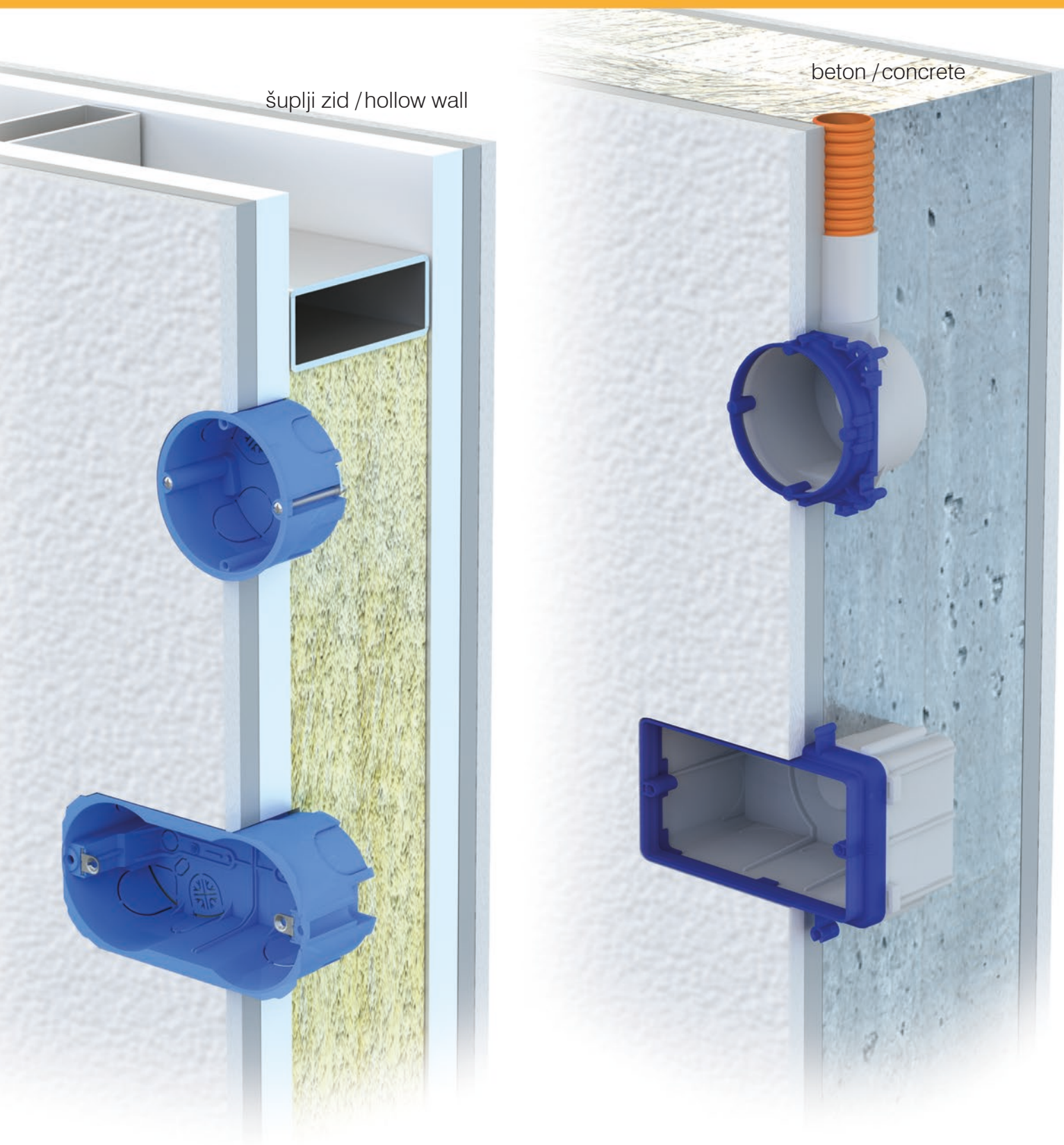

ostala rješenja

other solutions

IP44
podžbukna ugradnja
flush mounted



CUBO IP20
nadžbukna kutija
surface mounted boxes

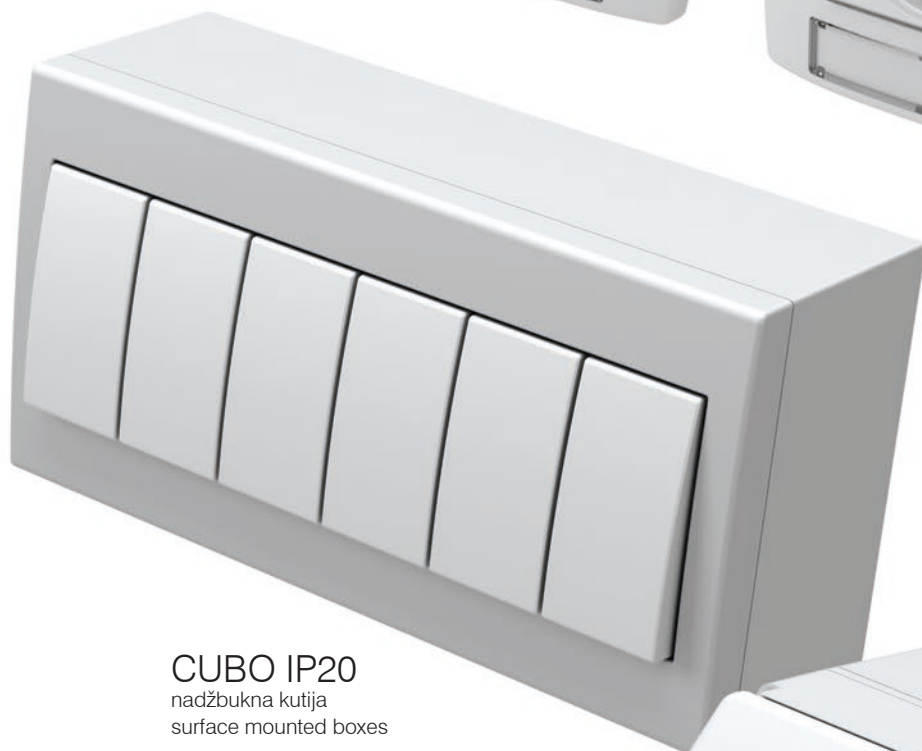

CUBO IP55
nadžbukna kutija
surface mounted boxes



Trebate li rješenje za sklopku ili utičnicu u nadžbuknoj, podžbuknoj ili podnoj varijanti? Modul pruža različita rješenja ugradnje s različitim IP zaštitama, za parapetne kanale, razdjelne ormariće ili podne kutije. Odabir je na vama.

Do you need switch or socket in flush, surface or floor solution? The Modul provides different mounting solutions with different IP protections, for trunking systems, distribution boards or floor boxes. The choice is yours.



MA

parapetni kanali
trunking systems

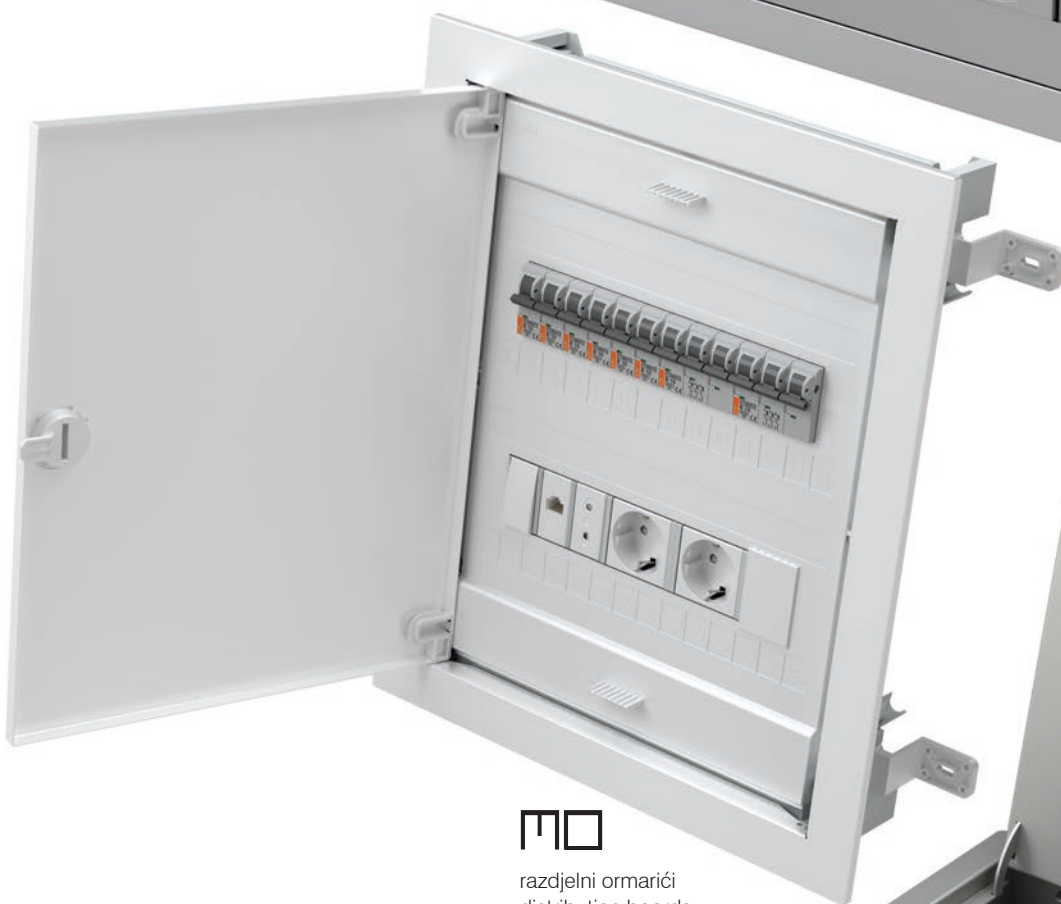

MO

razdjelni ormarići
distribution boards

MT

podne kutije
floor boxes



tehnički katalog

technical catalogue





MODUL

— funkcijski elementi
function elements



56

dizajn
design

PURE
~~line~~
soft



104

kutija
boxes



124

distribucija
distribution



146

ekonomik —



170

fontana —



198

TEM





FUNKCIJSKI ELEMENTI FUNCTION ELEMENTS

SKLOPKE SM
SWITCHES SM



58

TIPKE TM
BUTTONS TM



63

OSVJETLJENJE IA
ILLUMINATION IA



66

UTIČNICE VM
SOCKETS VM



68

KOMUNIKACIJE KM
COMMUNICATIONS KM



72

DODACI KOMUNIKACIJA KA
COMMUNICATION ACCESSORIES KA



78

ELEKTRONIKA EM
ELECTRONICS EM



80

SETOVI CM
SETS CM



96

ANTIBAKTERIJSKI PROGRAM AW
ANTIBACTERIAL PROGRAM AW



100

DIZAJN DESIGN

OKVIRI PURE OP
COVER PLATES PURE OP



104

OKVIRI LINE OL
COVER PLATES LINE OL



108

OKVIRI SOFT OS
COVER PLATES SOFT OS



112

NOSAČI NM
MOUNTING FRAMES NM



120

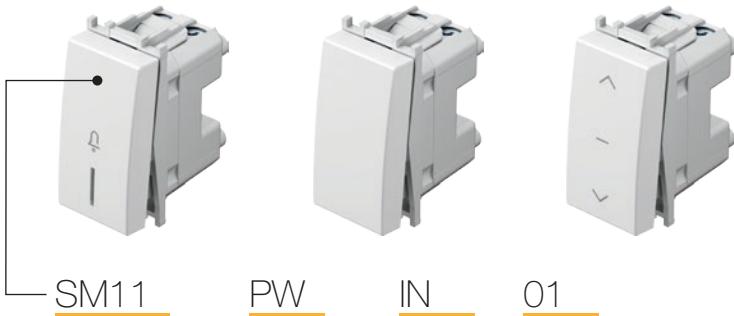

tip type	naziv description	tehnički podaci technical data	veličina size	boja colour	opcijski podaci 1 optional data 1	opcijski podaci 2 optional data 2
SM10	SKLOPKA JEDNOPOLNA SWITCH 1WAY	16AX 250V~	1M	<input type="checkbox"/> PW bijela sjajna polar white	<input type="checkbox"/> NT neutralna neutral	01
SM11	TIPKALO JEDNOPOLNO PUSH BUTTON 1WAY	16A 250V~	1M	<input checked="" type="checkbox"/> SB crna mat soft touch black	<input type="checkbox"/> IN indikator indicator	02
SM12	SKLOPKA JEDNOPOLNA SWITCH 1WAY	20A 250V~	1M	<input type="checkbox"/> ES srebrna mat elox silver		03
...	<input type="checkbox"/> IW bež sjajna ivory white		

SKLOPKA JEDNOPOLNA 16AX 250V~ 1M



SM10



- sklopka bez tipke
 - 16AX 250V~, tip SM10
 - sukladno normi EN 60669-1
 - vijčano pričvršćivanje vodiča presjeka 1,5-2,5 mm²
- SWITCH 1WAY 16AX 250V~ 1M**
- switch without button
 - 16AX 250V~, type SM10
 - in accordance with EN 60669-1
 - screw contacts 1.5-2.5mm²

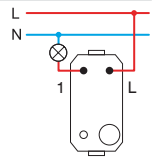

TIPKALO JEDNOPOLNO 16A 250V~ 1M



SM11



- tipkalo bez tipke
 - 16A 250V~, tip SM11
 - sukladno normi EN 60669-1
 - vijčano pričvršćivanje vodiča presjeka 1,5-2,5 mm²
- PUSH BUTTON 1WAY 16AX 250V~ 1M**
- push button without button
 - 16A 250V~, type SM11
 - in accordance with EN 60669-1
 - screw contacts 1.5-2.5mm²

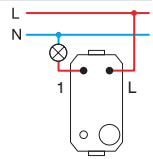

SKLOPKA JEDNOPOLNA 20A 250V~ 1M



SM12



- sklopka bez tipke
 - 20A 250V~, tip SM12
 - sukladno normi EN 60669-1
 - vijčano pričvršćivanje vodiča presjeka 1,5-2,5 mm²
- SWITCH 1WAY 20A 250V~ 1M**
- switch without button
 - 20A 250V~, type SM12
 - in accordance with EN 60669-1
 - screw contacts 1.5-2.5mm²

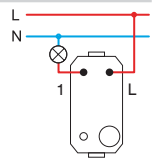

SKLOPKA DVOPOLNA 16AX 250V~ 1M



SM20

- sklopka bez tipke
 - 16AX 250V~, tip SM20
 - sukladno normi EN 60669-1
 - vijčano pričvršćivanje vodiča presjeka 1,5-2,5 mm²
 - samo u kombinaciji s tipkom TM15
- SWITCH 2POLE 16AX 250V~ 1M**
- switch without button
 - 16AX 250V~, type SM20
 - in accordance with EN 60669-1
 - screw contacts 1.5-2.5mm²
 - only in combination with button TM15

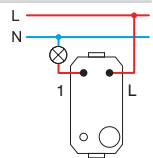

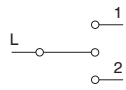

SM40

**SKLOPKA ŽALUZIJSKA 1-0-2 16AX 250V~ 1M**

- sklopka bez tipke
- 16AX 250V~, tip SM40
- sukladno normi EN 60669-1
- vijčano pričvršćivanje vodiča presjeka 1,5-2,5 mm²

SWITCH SHUTTERS 1-0-2 16AX 250V~ 1M

- switch without button
- 16AX 250V~, type SM40
- in accordance with EN 60669-1
- screw contacts 1.5-2.5mm²

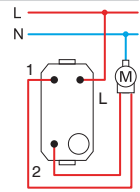

SM41

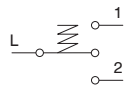
**TIPKALO ŽALUZIJSKO 1-0-2 16A 250V~ 1M**

- tipkalo bez tipke
- 16A 250V~, tip SM41
- sukladno normi EN 60669-1
- vijčano pričvršćivanje vodiča presjeka 1,5-2,5 mm²

PUSH BUTTON SHUTTERS 1-0-2 16A 250V~ 1M

- push button without button
- 16A 250V~, type SM41
- in accordance with EN 60669-1
- screw contacts 1.5-2.5mm²

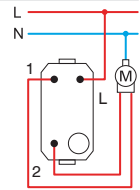

SM60

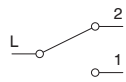
**SKLOPKA IZMJENIČNA 16AX 250V~ 1M**

- sklopka bez tipke
- 16AX 250V~, tip SM60
- sukladno normi EN 60669-1
- vijčano pričvršćivanje vodiča presjeka 1,5-2,5 mm²

SWITCH 2WAY 16AX 250V~ 1M

- switch without button
- 16AX 250V~, type SM60
- in accordance with EN 60669-1
- screw contacts 1.5-2.5mm²

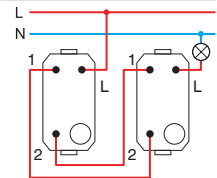

SM61

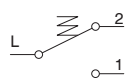
**TIPKALO IZMJENIČNO 16A 250V~ 1M**

- tipkalo bez tipke
- 16A 250V~, tip SM61
- sukladno normi EN 60669-1
- vijčano pričvršćivanje vodiča presjeka 1,5-2,5 mm²

PUSH BUTTON 2WAY 16A 250V~ 1M

- push button without button
- 16A 250V~, type SM61
- in accordance with EN 60669-1
- screw contacts 1.5-2.5mm²

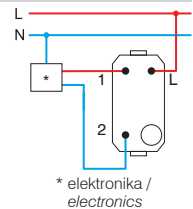

SM70

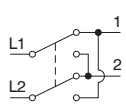
**SKLOPKA KRIŽNA 16AX 250V~ 1M**

- sklopka bez tipke
- 16AX 250V~, tip SM70
- sukladno normi EN 60669-1
- vijčano pričvršćivanje vodiča presjeka 1,5-2,5 mm²

SWITCH INTERMEDIATE 16AX 250V~ 1M

- switch without button
- 16AX 250V~, type SM70
- in accordance with EN 60669-1
- screw contacts 1.5-2.5mm²

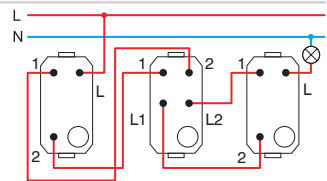

1M = 22,5 x 45
2M = 45 x 45

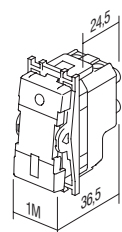
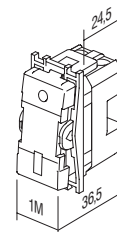



□ PW bijela sjajna
polar white



■ SB crna mat
soft touch black



□ ES srebrna mat
elox silver



□ IW bež sjajna
ivory white

SKLOPKA JEDNOPOLNA 16AX 250V~ 1M

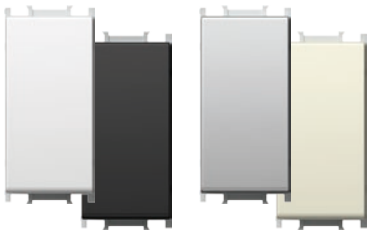

- SM10PW
- SM10SB
- SM10ES
- SM10IW

- 16AX 250V~, tip SM10
- sukladno normi EN 60669-1
- vijčano pričvršćivanje vodiča presjeka 1,5-2,5 mm²
- zamjenjiva tipka

SWITCH 1WAY 16AX 250V~ 1M

- 16AX 250V~, type SM10
- in accordance with EN 60669-1
- screw contacts 1.5-2.5 mm²
- replaceable button



SKLOPKA JEDNOPOLNA 16AX 250V~ 1M __ IN



- SM10PWIN
- SM10SBIN
- SM10ESIN
- SM10IWIN

- IN indikator
- 16AX 250V~, tip SM10
- sukladno normi EN 60669-1
- vijčano pričvršćivanje vodiča presjeka 1,5-2,5 mm²
- tinjalica nije ugrađena
- zamjenjiva tipka

SWITCH 1WAY 16AX 250V~ 1M __ IN

- IN indicator
- 16AX 250V~, type SM10
- in accordance with EN 60669-1
- screw contacts 1.5-2.5 mm²
- lamp is not included
- replaceable button



TIPKALO JEDNOPOLNO 16A 250V~ 1M

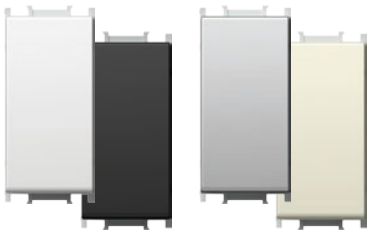

- SM11PW
- SM11SB
- SM11ES
- SM11IW

- 16A 250V~, tip SM11
- sukladno normi EN 60669-1
- vijčano pričvršćivanje vodiča presjeka 1,5-2,5 mm²
- zamjenjiva tipka

PUSH BUTTON 1WAY 16A 250V~ 1M

- 16A 250V~, type SM11
- in accordance with EN 60669-1
- screw contacts 1.5-2.5 mm²
- replaceable button



TIPKALO JEDNOPOLNO 16A 250V~ 1M __ IN 01



- SM11PWIN01
- SM11SBIN01
- SM11ESIN01
- SM11IWIN01

- indikatorsko zvono IN 01
- 16A 250V~, tip SM11
- sukladno normi EN 60669-1
- vijčano pričvršćivanje vodiča presjeka 1,5-2,5 mm²
- tinjalica nije ugrađena
- zamjenjiva tipka

PUSH BUTTON 1WAY 16A 250V~ 1M __ IN 01

- IN 01 indicator bell
- 16A 250V~, type SM11
- in accordance with EN 60669-1
- screw contacts 1.5-2.5 mm²
- lamp is not included
- replaceable button



TIPKALO JEDNOPOLNO 16A 250V~ 1M __ IN 02



- SM11PWIN02 - svjetlosna indikacija IN 02
- SM11SBIN02 - 16A 250V~, tip SM11
- SM11ESIN02 - sukladno normi EN 60669-1
- SM11WIN02 - vijčano pričvršćivanje vodiča presjeka 1,5-2,5 mm²
- tinjalica nije ugrađena
- zamjenjiva tipka

PUSH BUTTON 1WAY 16A 250V~ 1M __ IN 02

- IN 02 indicator light
- 16A 250V~, type SM11
- in accordance with EN 60669-1
- screw contacts 1.5-2.5 mm²
- lamp is not included
- replaceable button



SKLOPKA DVOPOLNA 16AX 250V~ 1M __ NT 03



- SM20PWNT03 - NT 03 neutralna 0-1
- SM20SBNT03 - 16AX 250V~, tip SM20
- SM20ESNT03 - sukladno normi EN 60669-1
- SM20IWNT03 - vijčano pričvršćivanje vodiča presjeka 1,5-2,5 mm²
- zamjenjiva tipka

SWITCH 2POLE 16AX 250V~ 1M __ NT 03

- NT 03 neutral 0-1
- 16AX 250V~, type SM20
- in accordance with EN 60669-1
- screw contacts 1.5-2.5 mm²
- replaceable button



SKLOPKA DVOPOLNA 16AX 250V~ 1M __ IN



- SM20PWIN - IN indikator
- SM20SBIN - 16AX 250V~, tip SM20
- SM20ESIN - sukladno normi EN 60669-1
- SM20IWIN - vijčano pričvršćivanje vodiča presjeka 1,5-2,5 mm²
- tinjalica nije ugrađena
- zamjenjiva tipka

SWITCH 2POLE 16AX 250V~ 1M __ IN

- IN indicator
- 16AX 250V~, type SM20
- in accordance with EN 60669-1
- screw contacts 1.5-2.5 mm²
- lamp is not included
- replaceable button



SKLOPKA ŽALUZIJSKA 1-0-2 16AX 250V~ 1M __ NT 10

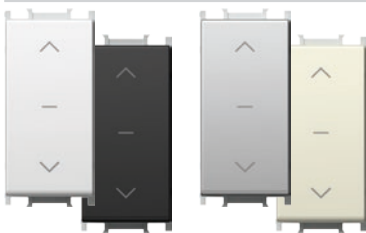

- SM40PWNT10 - NT 10 neutralna 1-0-2
- SM40SBNT10 - 16AX 250V~, tip SM40
- SM40ESNT10 - sukladno normi EN 60669-1
- SM40IWNT10 - vijčano pričvršćivanje vodiča presjeka 1,5-2,5 mm²
- zamjenjiva tipka

SWITCH SHUTTERS 1-0-2 16AX 250V~ 1M __ NT 10

- NT 10 neutral 1-0-2
- 16AX 250V~, type SM40
- in accordance with EN 60669-1
- screw contacts 1.5-2.5mm²
- replaceable button



TIPKALO ŽALUZIJSKO 1-0-2 16A 250V~ 1M __ NT 10

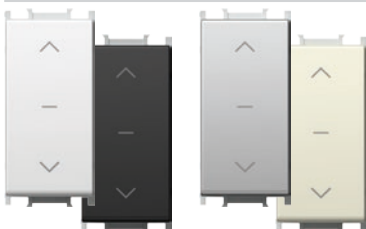

- SM41PWNT10 - NT 10 neutralna 1-0-2
- SM41SBNT10 - 16A 250V~, tip SM41
- SM41ESNT10 - sukladno normi EN 60669-1
- SM41IWNT10 - vijčano pričvršćivanje vodiča presjeka 1,5-2,5 mm²
- zamjenjiva tipka

PUSH BUTTON SHUTTERS 1-0-2 16A 250V~ 1M __ NT 10

- NT 10 neutral 1-0-2
- 16A 250V~, type SM41
- in accordance with EN 60669-1
- screw contacts 1.5-2.5mm²
- replaceable button



SKLOPKA IZMJENIČNA 16AX 250V~ 1M

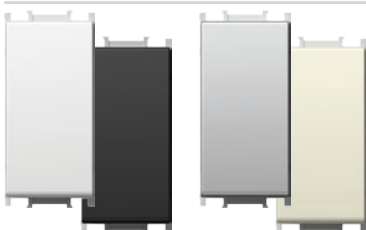

- SM60PW - 16AX 250V~, tip SM60
- SM60SB - sukladno normi EN 60669-1
- SM60ES - vijčano pričvršćivanje vodiča presjeka 1,5-2,5 mm²
- SM60IW - zamjenjiva tipka

SWITCH 2WAY 16AX 250V~ 1M

- 16AX 250V~, type SM60
- in accordance with EN 60669-1
- screw contacts 1.5-2.5 mm²
- replaceable button



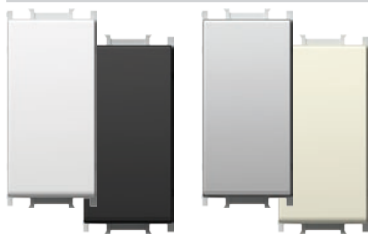

- SM61PW
- SM61SB
- SM61ES
- SM61IW

TIPKALO IZMJENIČNO 16A 250V~ 1M

- 16A 250V~, tip SM61
- sukladno normi EN 60669-1
- vijčano pričvršćivanje vodiča presjeka 1,5-2,5 mm²
- zamjenjiva tipka

PUSH BUTTON 2WAY 16A 250V~ 1M

- 16A 250V~, type SM61
- in accordance with EN 60669-1
- screw contacts 1.5-2.5 mm²
- replaceable button



- SM62PWCD
- SM62SBCD
- SM62ESCD
- SM62IWCD

TIPKALO IZMJENIČNO S UZICOM 16A 250V~ 1M __ CD

- CD indikator + uzica
- duljina uzice 1,5 m
- 16A 250V~, tip SM62
- sukladno normi EN 60669-1
- vijčano pričvršćivanje vodiča presjeka 1,5-2,5 mm²

PUSH BUTTON 2WAY WITH CORD 16A 250V~ 1M __ CD

- CD indikator + cord
- cord length 1.5m
- 16A 250V~, type SM62
- in accordance with EN 60669-1
- screw contacts 1.5-2.5 mm²

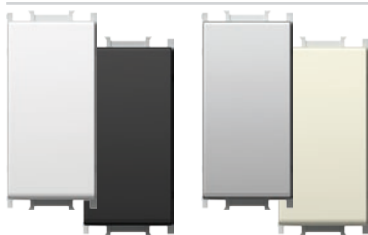

- SM70PW
- SM70SB
- SM70ES
- SM70IW

SKLOPKA KRIŽNA 16AX 250V~ 1M

- 16AX 250V~, tip SM70
- sukladno normi EN 60669-1
- vijčano pričvršćivanje vodiča presjeka 1,5-2,5 mm²
- zamjenjiva tipka

SWITCH INTERMEDIATE 16AX 250V~ 1M

- 16AX 250V~, type SM70
- in accordance with EN 60669-1
- screw contacts 1.5-2.5 mm²
- replaceable button



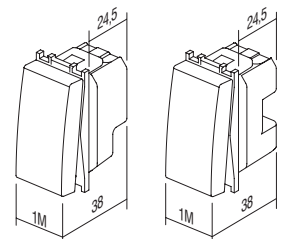

1M = 22,5 x 45
2M = 45 x 45

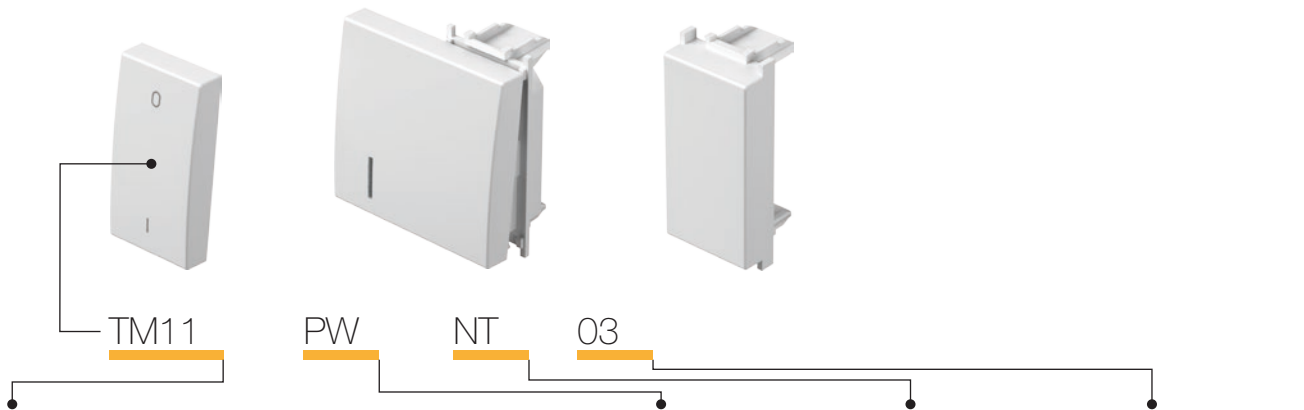

B U T T O N S T M



tip type	naziv description	tehnički podaci	veličina size	boja colour	opcijski podaci 1 optional data 1	opcijski podaci 2 optional data 2
TM11	TIPKA BUTTON		1M	<input type="checkbox"/> PW bijela sjajna polar white	<input type="checkbox"/> NT neutralna neutral	 01
TM12	TIPKA BUTTON		2M	<input checked="" type="checkbox"/> SB crna mat soft touch black	<input type="checkbox"/> IN indikator indicator	 02
TM21	SLIJEPI ELEMENT BLANK		1M	<input type="checkbox"/> ES srebrna mat elox silver		 03
.	.	.	.	<input type="checkbox"/> IW bež sjajna ivory white		
.	.	.	.			

TIPKA 1M

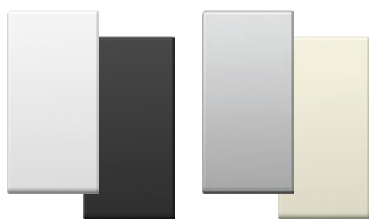

- TM11PW
- TM11SB
- TM11ES
- TM11IW

- zamjenjiva tipka 1M
- sukladno normi EN 60669-1

BUTTON 1M

- replaceable button 1M
- in accordance with EN 60669-1



TIPKA 1M INDIKATOR



- TM11PWIN
- TM11SBIN
- TM11ESIN
- TM11IWIN

- zamjenjiva tipka 1M
- sukladno normi EN 60669-1

BUTTON 1M INDICATOR

- replaceable button 1M
- in accordance with EN 60669-1



TIPKA 2M

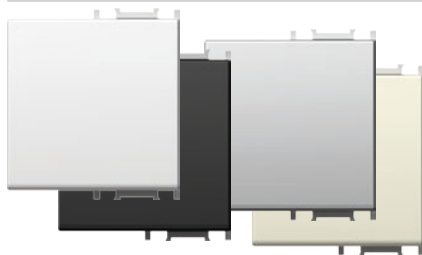

- TM12PW
- TM12SB
- TM12ES
- TM12IW

- zamjenjiva tipka 2M s nosačem tipke
- za nadogradnju sklopke ili tipke
s veličine 1M na veličinu 2M.
- sukladno normi EN 60669-1

BUTTON 2M

- replaceable button 2M with button carrier
- to upgrade switch or push button
from size 1M to size 2M
- in accordance with EN 60669-1



TIPKA 2M INDIKATOR

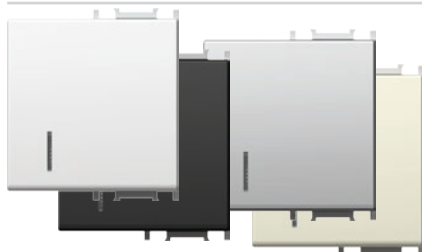

- TM12PWIN
- TM12SBIN
- TM12ESIN
- TM12IWIN

- zamjenjiva tipka 2M s nosačem tipke
- za nadogradnju sklopke ili tipke
s veličine 1M na veličinu 2M.
- sukladno normi EN 60669-1

BUTTON 2M INDICATOR

- replaceable button 2M with button carrier
- to upgrade switch or push button
from size 1M to size 2M
- in accordance with EN 60669-1



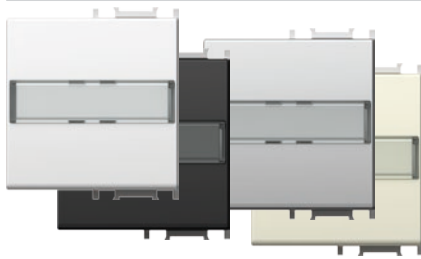

- TM13PWIL
- TM13SBIL
- TM13ESIL
- TM13IWIL

TIPKA 2M S NATPISNOM PLOČICOM

- zamjenjiva tipka 2M s nosačem tipke
- upotrebljava se pri nadogradnji sklopke ili tipkala od veličine 1M na veličinu 2M
- sukladno normi EN 60669-1

BUTTON 2M WITH INSCRIPTION PLATE

- replaceable button 2M with button carrier
- to upgrade switch or push button from size 1M to size 2M
- in accordance with EN 60669-1



- TM15PW
- TM15SB
- TM15ES
- TM15IW

TIPKA 1M DVOPOLNA

- zamjenjiva tipka 1M
- samo u kombinaciji s mehanizmom SM20
- sukladno normi EN 60669-1

BUTTON 1M 2POLE

- replaceable button 1M
- only in combination with mechanism SM20
- in accordance with EN 60669-1

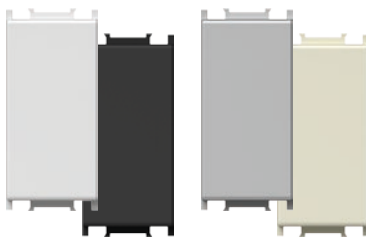

- TM21PW
- TM21SB
- TM21ES
- TM21IW

SLIJEPI ELEMENT 1M

- slijepi element za popunjavanje praznog mjesta
- sukladno normi EN 60669-1

BLANK 1M

- blank modul to fill up empty spaces
- in accordance with EN 60669-1

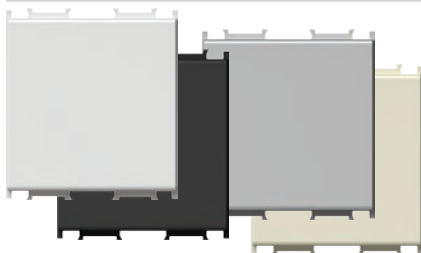

- TM22PW
- TM22SB
- TM22ES
- TM22IW

SLIJEPI ELEMENT 2M

- slijepi element za popunjavanje praznog mjesta
- sukladno normi EN 60669-1

BLANK 2M

- blank modul to fill up empty spaces
- in accordance with EN 60669-1

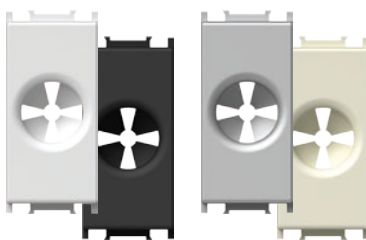

- TM31PW
- TM31SB
- TM31ES
- TM31IW

UVODNICA 1M

- uvodnica za kabel
- sukladno normi EN-60669-1

CABLE OUTLET 1M

- outlet for cable
- in accordance with EN-60669-1



1M = 22,5 x 45
2M = 45 x 45

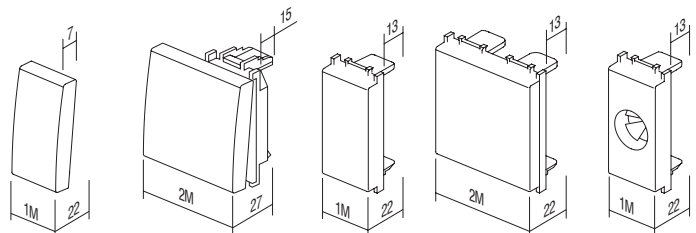

TM11
TM15

TM12
TM13

TM21

TM22

TM31

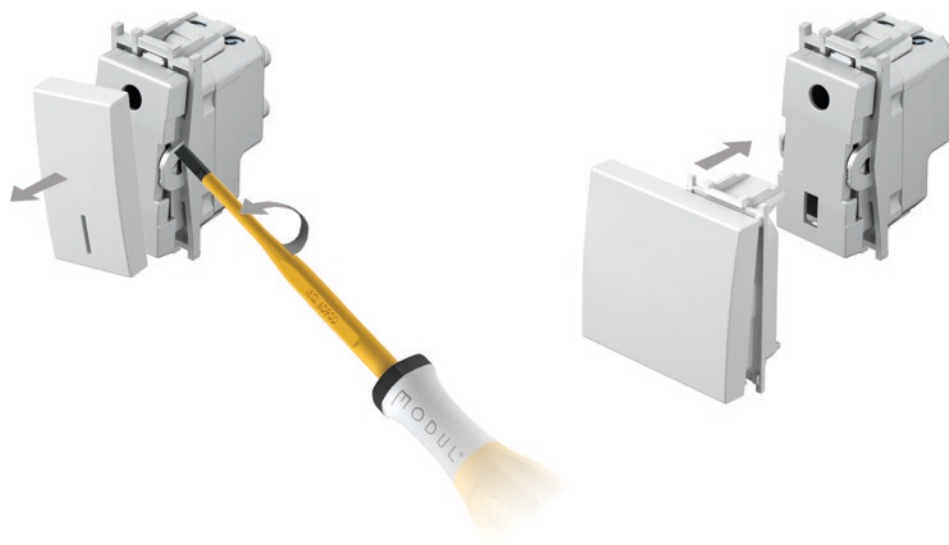

LASERSKO GRAVIRANJE NA TIPKAMA

- lasersko graviranje proizvoljne grafike na označenome mjestu
- standardni simboli dostupni sa skladišta, ostali na zahtjev

LASER PRINT ON BUTTONS

- laser print of any graphics on marked locations
- standard symbols from stock, other on request

1M

A
B
C

2M

A	D	G
B	E	H
C	F	I



SIMBOLI

SYMBOLS

01	02	03	04	05	06	07	08	09	10	11	12	20	21	22	23
24	25	26	27	28	29	30	31	32	33	34	35	36	37	38	39
					OFF	ON					AC				
40	41	42	43	44	45	46	47	48							

STANDARDNI SIMBOLI

STANDARD SYMBOLS

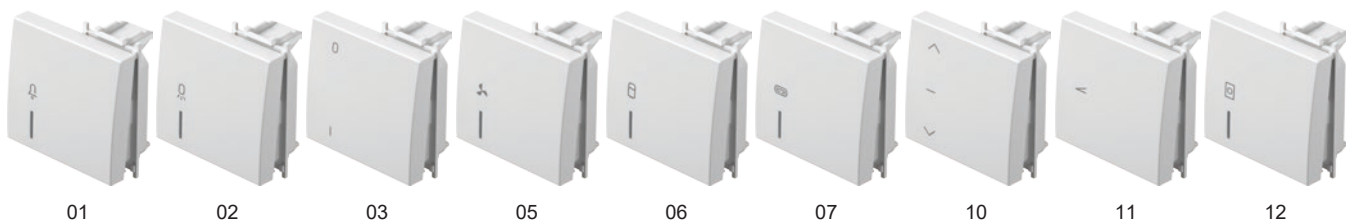

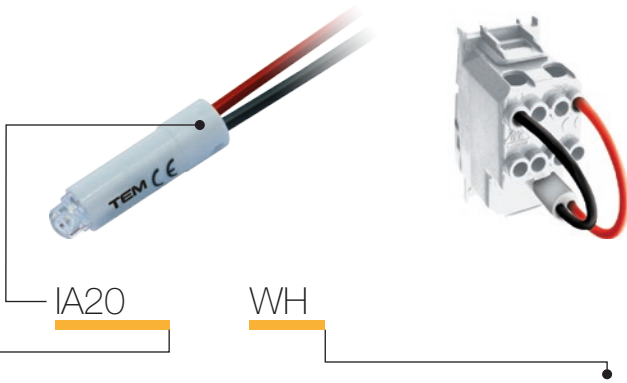

tip type	naziv description	tehnički podaci technical data	boja colour
IA10	NEONSKA TINJALICA NEON LAMP	230V~ 0,34W	<input type="checkbox"/> WH <i>bijela white</i>
IA20	LED TINJALICA LED LAMP	230V~ 0,40W	<input checked="" type="checkbox"/> BL <i>plava blue</i>
IA21	LED TINJALICA LED LAMP	24V AC/DC 0,20W	<input checked="" type="checkbox"/> RD <i>crvena red</i>
⋮	⋮	⋮	<input checked="" type="checkbox"/> GR <i>zelena green</i>
⋮	⋮	⋮	<input checked="" type="checkbox"/> OR <i>narančasta orange</i>

NEONSKA TINJALICA 230V~ 0,34W



IA10OR

- za indicaciju, osvjtljenje ili stalno osvjtljenje sklopke
- u kombinaciji s tipkom s indikatorom

NEON LAMP 230V~ 0,34W

- for indication, illumination or constant illumination of switch
- in combination with button with indicator

LED TINJALICA 230V AC/DC 0,40W



- IA20WH
- IA20GR
- IA20RD
- IA20BL

- za indicaciju, osvjtljenje ili stalno osvjtljenje sklopke
- u kombinaciji s tipkom s indikatorom

LED LAMP 230V AC/DC 0,40W

- for indication, illumination or constant illumination of switch
- in combination with button with indicator

LED TINJALICA 24V AC/DC 0,20W



- IA21WH
- IA21RD

- za indicaciju, osvjtljenje ili stalno osvjtljenje sklopke
- u kombinaciji s tipkom s indikatorom

LED LAMP 24V AC/DC 0,20W

- for indication, illumination or constant illumination of switch
- in combination with button with indicator

LED TINJALICA 12V AC/DC 0,10W



- IA22WH
- IA22RD

- za indicaciju, osvjtljenje ili stalno osvjtljenje sklopke
- u kombinaciji s tipkom s indikatorom

LED LAMP 12V AC/DC 0,10W

- for indication, illumination or constant illumination of switch
- in combination with button with indicator

I L L U M I N A T I O N I A

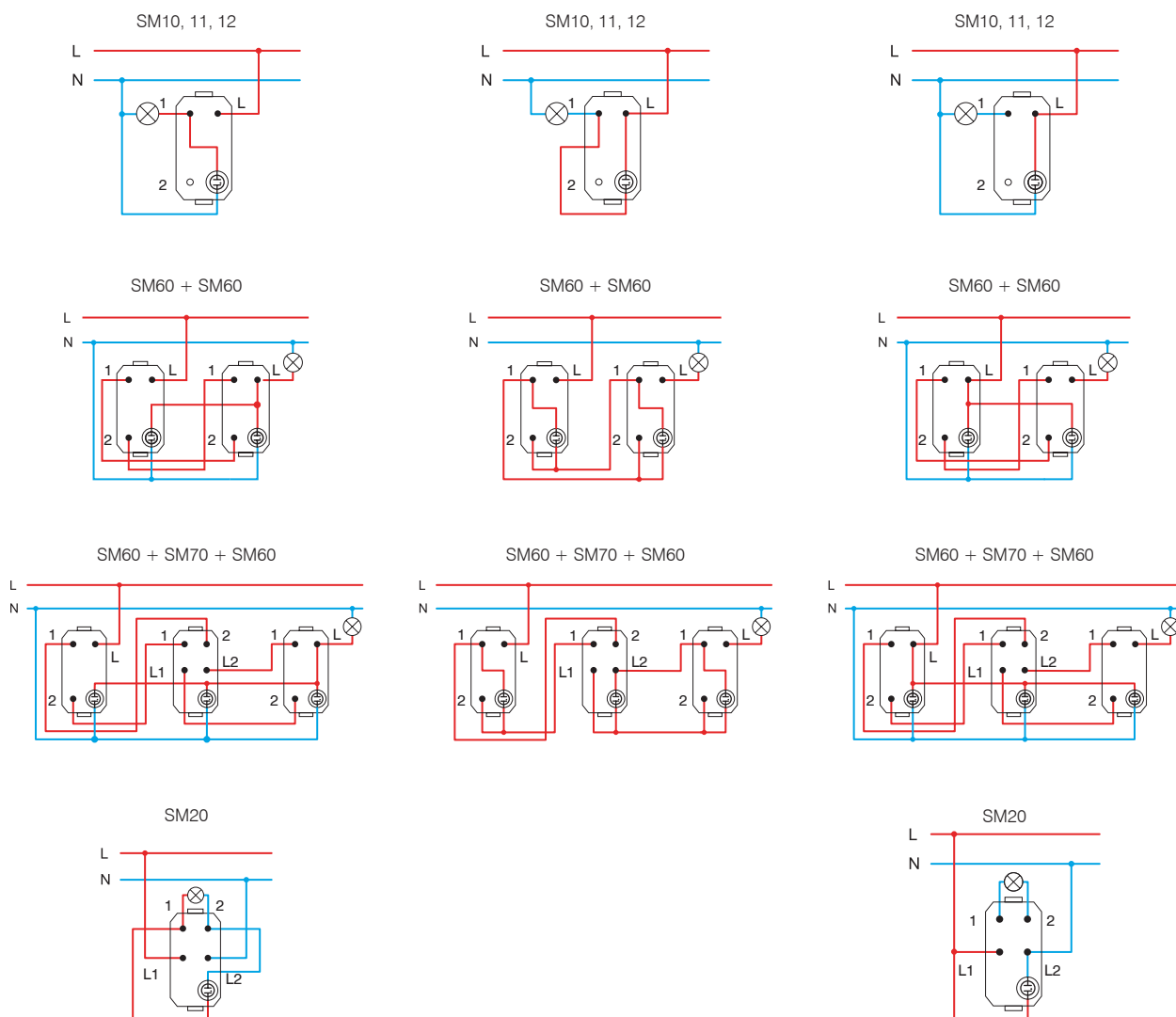
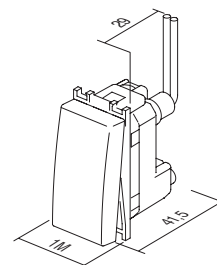
* Indikacija /
IndicationRasvjetna tijela /
IlluminationStalno osvijetljenje /
Constant illumination* spojne shema kompaktne fluorescentne tinjalice (CFL) /
wiring scheme for compact fluid lamp (CFL)1M = 22,5 x 45
2M = 45 x 45

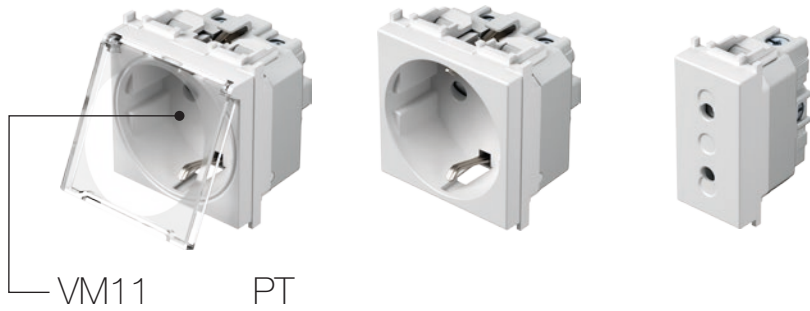

tip type	naziv description	tehnički podaci technical data	veličina size	boja colour																																				
VM10	UTIČNICA ŠUKO+KS SOCKET SCHUKO+KS	2P+E 16A 250V~	2M	<table border="0"> <tr> <td><input type="checkbox"/> PW</td> <td>bijela sjajna polar white</td> <td><input checked="" type="checkbox"/> PT</td> <td>bijela+prozirna white+transparent</td> <td><input type="checkbox"/> PP</td> <td>bijela+bijela white+white</td> </tr> </table>	<input type="checkbox"/> PW	bijela sjajna polar white	<input checked="" type="checkbox"/> PT	bijela+prozirna white+transparent	<input type="checkbox"/> PP	bijela+bijela white+white																														
<input type="checkbox"/> PW	bijela sjajna polar white	<input checked="" type="checkbox"/> PT	bijela+prozirna white+transparent	<input type="checkbox"/> PP	bijela+bijela white+white																																			
VM11	UTIČNICA ŠUKO+KS+POKLOPAC SOCKET SCHUKO+KS+COVER	2P+E 16A 250V~	2M	<table border="0"> <tr> <td><input checked="" type="checkbox"/> SB</td> <td>crna mat soft touch black</td> <td><input checked="" type="checkbox"/> BT</td> <td>lagani dodir soft touch black+transparent</td> <td><input checked="" type="checkbox"/> BB</td> <td>lagani dodir soft touch black+black</td> </tr> <tr> <td><input type="checkbox"/> ES</td> <td>srebrna mat elox silver bež sjajna</td> <td><input checked="" type="checkbox"/> ST</td> <td>srebrna+prozirna silver+transparent</td> <td><input type="checkbox"/> SS</td> <td>srebrna+srebrna silver+silver</td> </tr> <tr> <td><input type="checkbox"/> IW</td> <td>ivory white</td> <td><input checked="" type="checkbox"/> IT</td> <td>bež+prozirna ivory+transparent</td> <td><input type="checkbox"/> II</td> <td>bež+bež ivory+ivory</td> </tr> <tr> <td><input checked="" type="checkbox"/> RD</td> <td>crvena red</td> <td><input checked="" type="checkbox"/> RT</td> <td>crvena+prozirna red+transparent</td> <td><input checked="" type="checkbox"/> RR</td> <td>crvena+crvena red+red</td> </tr> <tr> <td><input checked="" type="checkbox"/> GR</td> <td>zelen green</td> <td><input checked="" type="checkbox"/> GT</td> <td>zelen+prozirna green+transparent</td> <td><input checked="" type="checkbox"/> GG</td> <td>zelen+zelen green+green</td> </tr> <tr> <td><input checked="" type="checkbox"/> OR</td> <td>narančasta orange</td> <td><input checked="" type="checkbox"/> OT</td> <td>narančasta+prozirna orange+transparent</td> <td><input checked="" type="checkbox"/> OO</td> <td>narančasta+narančasta orange+orange</td> </tr> </table>	<input checked="" type="checkbox"/> SB	crna mat soft touch black	<input checked="" type="checkbox"/> BT	lagani dodir soft touch black+transparent	<input checked="" type="checkbox"/> BB	lagani dodir soft touch black+black	<input type="checkbox"/> ES	srebrna mat elox silver bež sjajna	<input checked="" type="checkbox"/> ST	srebrna+prozirna silver+transparent	<input type="checkbox"/> SS	srebrna+srebrna silver+silver	<input type="checkbox"/> IW	ivory white	<input checked="" type="checkbox"/> IT	bež+prozirna ivory+transparent	<input type="checkbox"/> II	bež+bež ivory+ivory	<input checked="" type="checkbox"/> RD	crvena red	<input checked="" type="checkbox"/> RT	crvena+prozirna red+transparent	<input checked="" type="checkbox"/> RR	crvena+crvena red+red	<input checked="" type="checkbox"/> GR	zelen green	<input checked="" type="checkbox"/> GT	zelen+prozirna green+transparent	<input checked="" type="checkbox"/> GG	zelen+zelen green+green	<input checked="" type="checkbox"/> OR	narančasta orange	<input checked="" type="checkbox"/> OT	narančasta+prozirna orange+transparent	<input checked="" type="checkbox"/> OO	narančasta+narančasta orange+orange
<input checked="" type="checkbox"/> SB	crna mat soft touch black	<input checked="" type="checkbox"/> BT	lagani dodir soft touch black+transparent	<input checked="" type="checkbox"/> BB	lagani dodir soft touch black+black																																			
<input type="checkbox"/> ES	srebrna mat elox silver bež sjajna	<input checked="" type="checkbox"/> ST	srebrna+prozirna silver+transparent	<input type="checkbox"/> SS	srebrna+srebrna silver+silver																																			
<input type="checkbox"/> IW	ivory white	<input checked="" type="checkbox"/> IT	bež+prozirna ivory+transparent	<input type="checkbox"/> II	bež+bež ivory+ivory																																			
<input checked="" type="checkbox"/> RD	crvena red	<input checked="" type="checkbox"/> RT	crvena+prozirna red+transparent	<input checked="" type="checkbox"/> RR	crvena+crvena red+red																																			
<input checked="" type="checkbox"/> GR	zelen green	<input checked="" type="checkbox"/> GT	zelen+prozirna green+transparent	<input checked="" type="checkbox"/> GG	zelen+zelen green+green																																			
<input checked="" type="checkbox"/> OR	narančasta orange	<input checked="" type="checkbox"/> OT	narančasta+prozirna orange+transparent	<input checked="" type="checkbox"/> OO	narančasta+narančasta orange+orange																																			
VM20	UTIČNICA EURO+KS SOCKET EURO+KS	2P 10A 250V~	1M																																					



UTIČNICA ŠUKO+KS 2P+E 16A 250V~ 2M

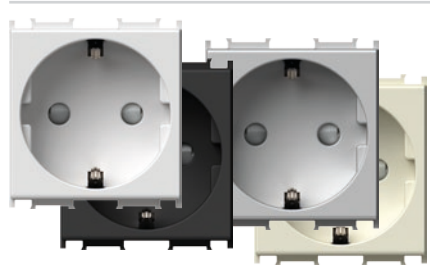

- VM10PW
- VM10SB
- VM10ES
- VM10IW

- 2P+E šuko
- 16A 250V~, tip VM10
- sukladno normama IEC 60884-1, CEE7
- vijčano pričvršćivanje vodiča presjeka 1,5-2,5 mm²
- KS zaštita za djecu od dodira kontakta

SOCKET SCHUKO+KS 2P+E 16A 250V~ 2M

- 2P+E schuko
- 16A 250V~, type VM10
- in accordance with IEC 60884-1, CEE7
- screw contacts 1.5-2.5 mm²
- KS build-in child protection - shuttered live contacts



UTIČNICA ŠUKO+KS 2P+E 16A 250V~ 2M

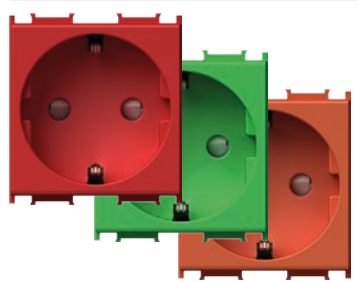

- VM10RD
- VM10GR
- VM10OR

- 2P+E šuko
- 16A 250V~, tip VM10
- sukladno normama IEC 60884-1, CEE7
- vijčano pričvršćivanje vodiča presjeka 1,5-2,5 mm²
- KS zaštita za djecu od dodira kontakta

SOCKET SCHUKO+KS 2P+E 16A 250V~ 2M

- 2P+E schuko
- 16A 250V~, type VM10
- in accordance with IEC 60884-1, CEE7
- screw contacts 1.5-2.5 mm²
- KS build-in child protection - shuttered live contacts



UTIČNICA ŠUKO+KS +POKLOPAC 2P+E 16A 250V~ 2M



- VM11PT
- VM11BT
- VM11ST
- VM11IT
- VM11PP

- 2P+E šuko + poklopac
- 16A 250V~, tip VM11
- sukladno normama IEC 60884-1, CEE7
- vijčano pričvršćivanje vodiča presjeka 1,5-2,5 mm²
- KS zaštita za djecu od dodira kontakta

SOCKET SCHUKO+KS+COVER

2P+E 16A 250V~ 2M
- 2P+E schuko+cover
- 16A 250V~, type VM11
- in accordance with IEC 60884-1, CEE7
- screw contacts 1.5-2.5 mm²
- KS build-in child protection - shuttered live contacts



UTIČNICA EURO+KS 2P 10A 250V~ 1M

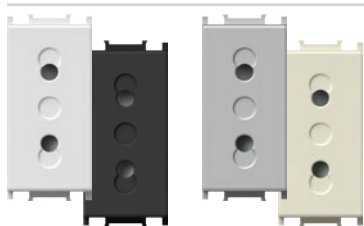

- VM20PW
- VM20SB
- VM20ES
- VM20IW

- 2P Euro
- 10A 250V~, tip VM20
- sukladno normama IEC 60884-1, CEE7
- vijčano pričvršćivanje vodiča presjeka 1,5-2,5 mm²
- KS zaštita za djecu od dodira kontakta



SOCKET EURO+KS 2P 10A 250V~ 1M

- 2P Euro
- 10A 250V~, type VM20
- in accordance with IEC 60884-1, CEE7
- screw contacts 1.5-2.5 mm²
- KS build-in child protection - shuttered live contacts

UTIČNICA FRANCUSKA+KS 2P+E 16A 250V~ 2M



- VM40PW
- VM40SB
- VM40ES
- VM40IW

- 2P+E francuska
- 16A 250V~, tip VM40
- sukladno normama IEC 60884-1, NF C 61-314 CEE7
- vijčano pričvršćivanje vodiča presjeka 1,5-2,5 mm²
- KS zaštita za djecu od dodira kontakta



SOCKET FRENCH+KS 2P+E 16A 250V~ 2M

- 2P+E French
- 16A 250V~, type VM40
- in accordance with IEC 60884-1, NF C 61-314, CEE7
- screw contacts 1.5-2.5 mm²
- KS build-in child protection - shuttered live contacts

UTIČNICA FRANCUSKA+KS 2P+E 16A 250V~ 2M

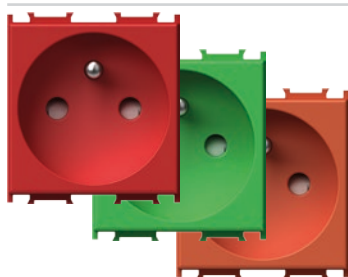

- VM40RD
- VM40GR
- VM40OR

- 2P+E francuska
- 16A 250V~, tip VM40
- sukladno normama IEC 60884-1, NF C 61-314 CEE7
- vijčano pričvršćivanje vodiča presjeka 1,5-2,5 mm²
- KS zaštita za djecu od dodira kontakta



SOCKET FRENCH+KS 2P+E 16A 250V~ 2M

- 2P+E French
- 16A 250V~, type VM40
- in accordance with IEC 60884-1, NF C 61-314, CEE7
- screw contacts 1.5-2.5 mm²
- KS build-in child protection - shuttered live contacts

UTIČNICA FRANCUSKA+KS+POKLOPAC 2P+E 16A 250V~ 2M



- VM41PT
- VM41BT
- VM41ST
- VM41IT

- 2P+E francuska+poklopac
- 16A 250V~, tip VM41
- sukladno normama IEC 60884-1, NF C 61-314 CEE7
- vijčano pričvršćivanje vodiča presjeka 1,5-2,5 mm²
- KS zaštita za djecu od dodira kontakta



SOCKET FRENCH+KS+COVER

- 2P+E 16A 250V~ 2M
- 2P+E French+cover
- 16A 250V~, type VM41
- in accordance with IEC 60884-1, NF C 61-314, CEE7
- screw contacts 1.5-2.5 mm²
- KS build-in child protection - shuttered live contacts

UTIČNICA TALIJANSKA P17/11+KS 2P+E 16A 250V~ 1M

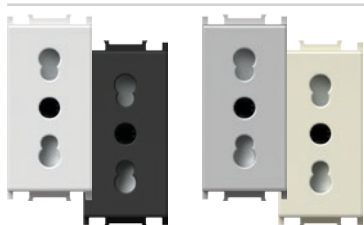

- VM30PW
- VM30SB
- VM30ES
- VM30IW

- 2P+E talijanska P17/11
- 16A 250V~, tip VM30
- sukladno normama IEC 60884-1, CEI 23-50
- vijčano pričvršćivanje vodiča presjeka 1,5-2,5 mm²
- KS zaštita za djecu od dodira kontakta



SOCKET ITALIAN P17/11+KS 2P+E 16A 250V~ 1M

- 2P+E Italian P17/11
- 16A 250V~, type VM30
- in accordance with IEC 60884-1, CEI 23-50
- screw contacts 1.5-2.5 mm²
- KS build-in child protection - shuttered live contacts

UTIČNICA ŠUKO TALIJANSKA P17/11+KS 2P+E 16A 250V~ 2M

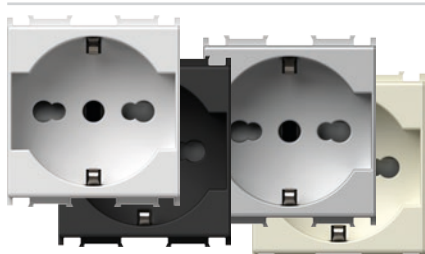

- VM31PW
- VM31SB
- VM31ES
- VM31IW

- 2P+E šuko/talijanska P17/11
- 16A 250V~, tip VM31
- sukladno normama IEC 60884-1, CEI 23-50
- vijčano pričvršćivanje vodiča presjeka 1,5-2,5 mm²
- KS zaštita za djecu od dodira kontakta

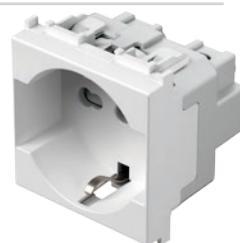

SOCKET SCHUKO/ITAL P17/11+KS

- 2P+E 16A 250V~ 2M
- 2P+E schuko/Italian P17/11
- 16A 250V~, type VM31
- in accordance with IEC 60884-1, CEI 23-50
- screw contacts 1.5-2.5 mm²
- KS build-in child protection - shuttered live contacts

UTIČNICA ŠUKO TALIJANSKA P30+KS 2P+E 16A 250V~ 2M

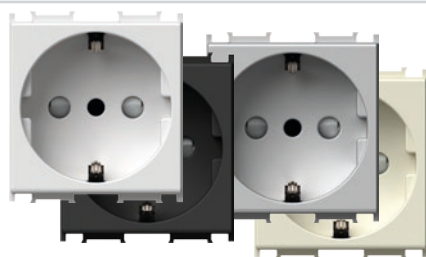

- VM32PW
- VM32SB
- VM32ES
- VM32IW

- 2P+E šuko/talijanska P30
- 16A 250V~, tip VM32
- sukladno normama IEC 60884-1, CEI 23-50
- vijčano pričvršćivanje vodiča presjeka 1,5-2,5 mm²
- KS zaštita za djecu od dodira kontakta

**SOCKET SCHUKO/ITAL P30+KS
2P+E 16A 250V~ 2M**

- 2P+E schuko/italian P30
- 16A 250V~, type VM32
- in accordance with IEC 60884-1, CEI 23-50
- screw contacts 1.5-2.5 mm²
- KS build-in child protection - shuttered live contacts



UTIČNICA TALIJANSKA P11+KS 2P+E 10A 250V~ 1M

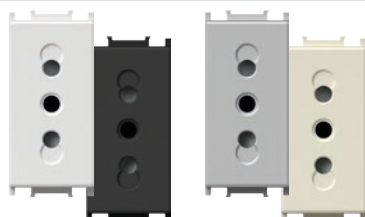

- VM33PW
- VM33SB
- VM33ES
- VM33IW

- 2P+E talijanska P11
- 10A 250V~, tip VM33
- sukladno normama IEC 60884-1, CEI 23-50
- vijčano pričvršćivanje vodiča presjeka 1,5-2,5 mm²
- KS zaštita za djecu od dodira kontakta

SOCKET ITALIAN P11+KS 2P+E 10A 250V~ 1M

- 2P+E Italian P11
- 10A 250V~, type VM33
- in accordance with IEC 60884-1, CEI 23-50
- screw contacts 1.5-2.5 mm²
- KS build-in child protection - shuttered live contacts



UTIČNICA EURO/AMERIČKA+KS 2P 16A 250V~ 1M

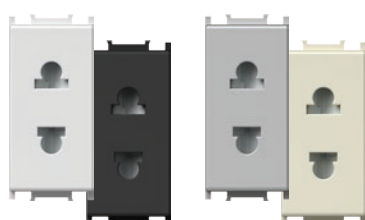

- VM21PW
- VM21SB
- VM21ES
- VM21IW

- 2P euro/američka
- 16A 250V~, tip VM21
- vijčano pričvršćivanje vodiča presjeka 1,5-2,5 mm²
- KS zaštita za djecu od dodira kontakta
- samo za zemlje koje nisu članice EU-a

SOCKET EURO/AMERICAN+KS 2P 16A 250V~ 1M

- 2P Euro/American
- 16A 250V~, type VM21
- screw contacts 1.5-2.5 mm²
- KS build-in child protection - shuttered live contacts
- only for countries not members of EU



UTIČNICA BRITANSKA BS 546+KS 2P+E 15A 250V~ 2M

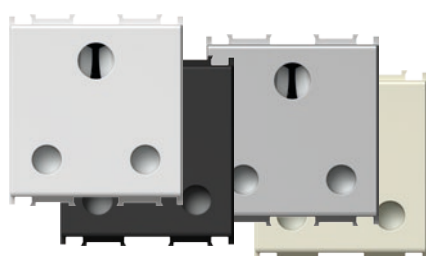

- VM51PW
- VM51SB
- VM51ES
- VM51IW

- 2P+E britanska BS 546
- 15A 250V~, tip VM51
- sukladno normi BS 546
- vijčano pričvršćivanje vodiča presjeka 1,5-4 mm²
- KS zaštita za djecu od dodira kontakta

SOCKET BRITISH BS 546+KS 2P+E 15A 250V~ 2M

- 2P+E British BS 546
- 15A 250V~, type VM51
- in accordance with BS 546
- screw contacts 1.5-4 mm²
- KS build-in child protection - shuttered live contacts



UTIČNICA BRITANSKA BS 1363-2+KS 2P+E 13A 250V~ 2M

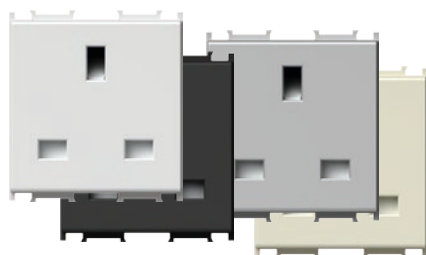

- VM52PW
- VM52SB
- VM52ES
- VM52IW

- 2P+E britanska BS 1363-2
- 13A 250V~, tip VM52
- sukladno normi BS 1363-2
- vijčano pričvršćivanje vodiča presjeka 1,5-4 mm²
- KS zaštita za djecu od dodira kontakta

SOCKET BRITISH BS 1363-2+KS 2P+E 13A 250V~ 2M

- 2P+E British BS 1363-2
- 13A 250V~, type VM52
- in accordance with BS 1363-2
- screw contacts 1.5-4 mm²
- KS build-in child protection - shuttered live contacts



PRENAPONSKA ZAŠTITA MPE MINI 275V/50Hz



VM80

- paralelni spoj s prvom utičnicom u nizu
- razred zaštite III
- U_c = 275Vac, U_{oc}/I_{sc} = 6kV/3kA, U_p < 800V
- sukladno normi IEC 61643-1
- vodiči presjeka 1,5 mm², IP20
- zvučni signal u slučaju proboja



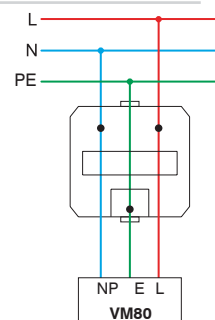

SURGE PROTECTOR MPE MINI 275V/50Hz

- parallel connection with the first socket in the row
- protection class III
- U_c = 275Vac, U_{oc}/I_{sc} = 6kV/3kA, U_p < 800V
- in accordance with IEC 61643-1
- wires 1.5mm², IP20
- sound signal at breakdown





S O C K E T S V M

POVEZIVANJE UTIČNICA I UTIKAČA
SOCKETS AND PLUGS MATCHING

UTIČNICA / SOCKET	VM10 VM11	VM20	VM30	VM33	VM31	VM32	VM40 VM41	VM21
VRSTA UTIKAČA / PLUG STYLE								
Njemački / German 	•				•	•		
Francuski / French 	•				•	•	•	
Talijanski / Italian S11 			•	•	•	•		
Talijanski / Italian S17 			•		•			
euro 	•	•	•		•	•	•	•

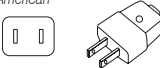
POVEZIVANJE UTIČNICA I UTIKAČA
SOCKETS AND PLUGS MATCHING

UTIČNICA / SOCKET	VM21	VM51	VM52
VRSTA UTIKAČA / PLUG STYLE			
Američki / American 	•		
Britanski / British BS 546 		•	
Britanski / British BS 1363-2 			•

1M = 22,5 x 45
2M = 45 x 45

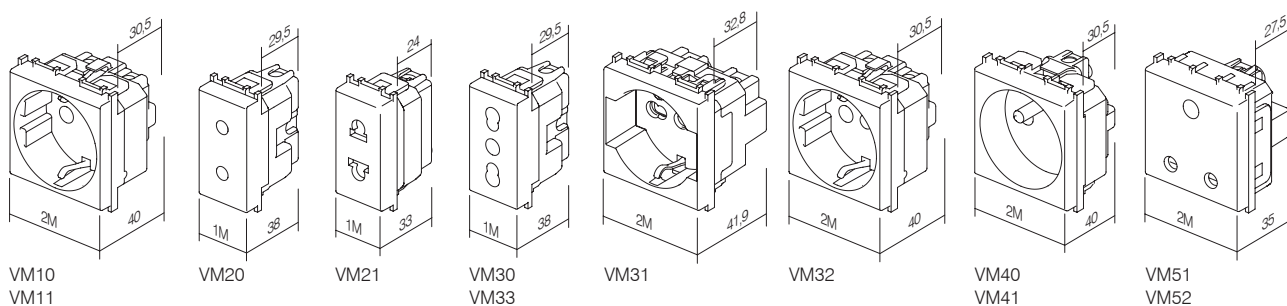



tip type	naziv description	tehnički podaci technical data	veličina size	boja colour
KM10	UTIČNICA TV OSNOVNA SOCKET TV BASIC	0dB	1M	<input type="checkbox"/> PW bijela sjajna polar white
KM11	UTIČNICA TV ZAVRŠNA SOCKET TV END-LINE	1dB	1M	<input type="checkbox"/> SB crna mat soft touch black
KM12	UTIČNICA TV PROLAZNA SOCKET TV TROUGHPASS	10dB	1M	<input type="checkbox"/> ES srebrna mat elox silver
...	<input type="checkbox"/> IW bež sjajna ivory white

UTIČNICA TV OSNOVNA 0dB 1M

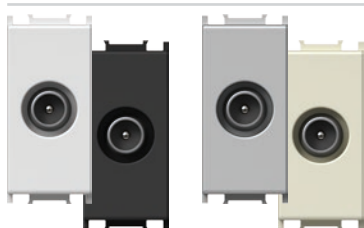

- KM10PW
- KM10SB
- KM10ES
- KM10IW

- TV osnovna
 - prigušenje 0dB
 - stražnji konektor – F standard
- SOCKET TV BASIC 0dB 1M**
- TV basic
 - reduction 0dB
 - back connector – F standard



UTIČNICA TV OSNOVNA 0dB 2M

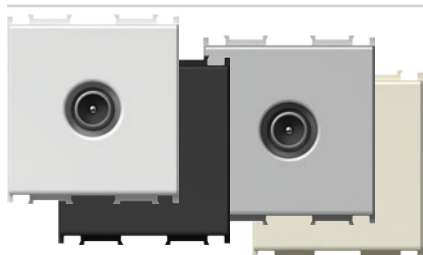

- KM20PW
- KM20SB
- KM20ES
- KM20IW

- TV osnovna
 - prigušenje 0dB
 - stražnji konektor – F standard
- SOCKET TV BASIC 0dB 2M**
- TV basic
 - reduction 0dB
 - back connector – F standard



UTIČNICA TV ZAVRŠNA 1dB 1M

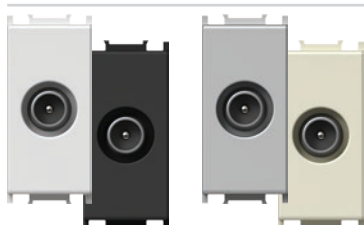

- KM11PW
- KM11SB
- KM11ES
- KM11IW

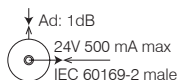

- TV završna
 - propušta frekvenciju u rasponu 5÷2400 MHz
 - prigušenje < 1 dB
 - sukladno normi EN 50083-1
 - vijčano pričvršćivanje vodiča
- SOCKET TV END-LINE 1dB 1M**
- TV end-line
 - frequency range 5÷2400 MHz
 - reduction < 1 dB
 - in accordance with EN 50083-1
 - screw contacts



UTIČNICA TV PROLAZNA 10dB 1M

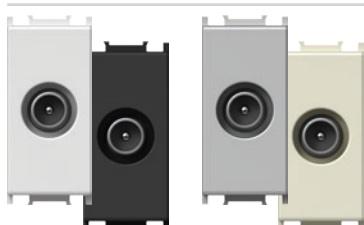

- KM12PW
- KM12SB
- KM12ES
- KM12IW

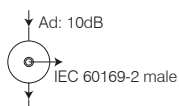

- TV prolazna
 - propušta frekvenciju u rasponu 5÷2400 MHz
 - prigušenje < 10 dB
 - sukladno normi EN 50083-1
 - vijčano pričvršćivanje vodiča
- SOCKET TV TROUGHPASS 10dB 1M**
- TV troughpass
 - frequency range 5÷2400 MHz
 - reduction < 10 dB
 - in accordance with EN 50083-1
 - screw contacts



UTIČNICA SAT OSNOVNA 0dB 1M

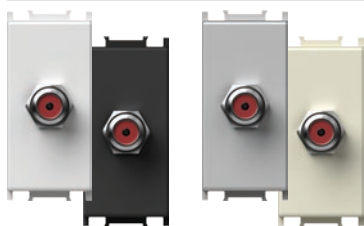

- KM15PW
- KM15SB
- KM15ES
- KM15IW

- SAT osnovna
- prigušenje 0dB
- stražnji konektor – F standard

SOCKET SAT BASIC 0dB 1M

- SAT basic
- reduction 0dB
- back connector – F standard



UTIČNICA SAT OSNOVNA 0dB 2M



- KM24PW
- KM24SB
- KM24ES
- KM24IW

- SAT osnovna
- prigušenje 0dB
- stražnji konektor – F standard

SOCKET SAT BASIC 0dB 2M

- SAT basic
- reduction 0dB
- back connector – F standard



UTIČNICA SAT ZAVRŠNA 1dB 1M

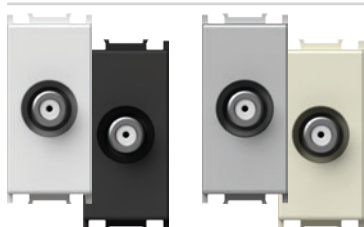

- KM16PW
- KM16SB
- KM16ES
- KM16IW

- SAT završna
- propušta frekvenciju u rasponu 5÷2400 MHz
- prigušenje < 1dB
- sukladno normi EN 50083-1
- vijčano pričvršćivanje vodiča

SOCKET SAT END-LINE 1dB 1M

- SAT end-line
- frequency range 5÷2400 MHz
- reduction < 1dB
- in accordance with EN 50083-1
- screw contacts

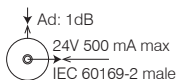

UTIČNICA R OSNOVNA 0dB 1M



- KM19PW
- KM19SB
- KM19ES
- KM19IW

- R OSNOVNA
- prigušenje 0dB
- stražnji konektor – F standard

SOCKET R BASIC 0dB 1M

- R basic
- reduction 0dB
- back connector – F standard



UTIČNICA R OSNOVNA 0dB 2M

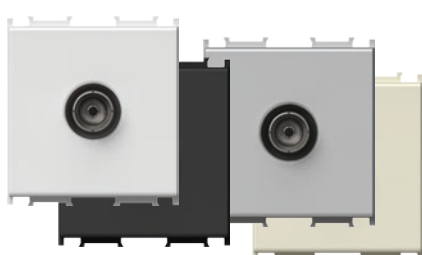

- KM29PW
- KM29SB
- KM29ES
- KM29IW

- R osnovna
- prigušenje 0dB
- stražnji konektor – F standard

SOCKET R BASIC 0dB 2M

- R basic
- reduction 0dB
- back connector – F standard



UTIČNICA SAT ZAVRŠNA 1dB 2M

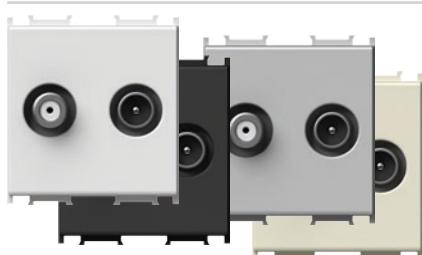

- KM25PW
- KM25SB
- KM25ES
- KM25IW

- SAT-TV završna
- propušta frekvenciju u rasponu 5÷2400 MHz
- prigušenje < 1dB
- sukladno normi EN 50083-1
- vijčano pričvršćivanje vodiča

SOCKET SAT-TV END-LINE 1dB 2M

- SAT-TV end-line
- frequency range 5÷2400 MHz
- reduction < 1dB
- in accordance with EN 50083-1
- screw contacts

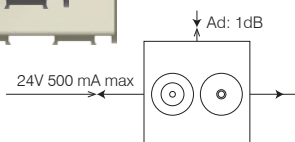

PRIMJERI OSNOVNOG SPOJA
BASIC CONNECTION SAMPLES

pojedinačni spoj
stand alone connection

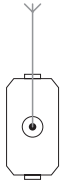

KM10
KM20
KM11
KM15
KM24
KM16
KM19
KM29
KM25

zvjezdasti spoj
star connection

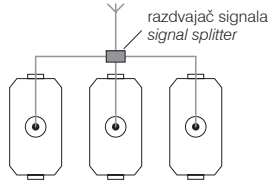

KM10
KM20
KM11
KM15
KM24
KM16
KM19
KM29
KM25

prolazni spoj
throughpass connection

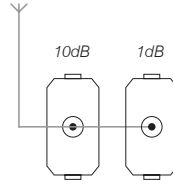

KM12 KM11



- KM22PW
- KM22SB
- KM22ES
- KM22IW

UTIČNICA AUDIO 2xRCA 1M

- audio 2x RCA
- lemljenje spojeva kabela na stražnjoj strani

SOCKET AUDIO 2xRCA 1M

- audio 2x RCA
- soldering connection of cable at the back side



- KM23PW
- KM23SB
- KM23ES
- KM23IW

UTIČNICA AUDIO ZVUČNICI 1M

- audio 2x Ø4 mm
- pričvršćivanje vodiča za zvučnike umetanjem ili banana utikačem Ø4 mm
- lemljenje spojeva kabela na stražnjoj strani

SOCKET AUDIO LOUDSPEAKERS 1M

- audio 2x Ø4mm
- to accommodate speaker wire, banana plug Ø4mm or spades
- soldering connection of cable at the back side



- KM26PW
- KM26SB
- KM26ES
- KM26IW

UTIČNICA AUDIO ZVUČNICI 2M

- audio 2x Ø4 mm
- pričvršćivanje vodiča za zvučnike umetanjem ili banana utikačem Ø4 mm
- lemljenje spojeva kabela na stražnjoj strani

SOCKET AUDIO LOUDSPEAKERS 2M

- audio 2x Ø4mm
- to accommodate speaker wire, banana plug Ø4mm or spades
- soldering connection of cable at the back side



1M = 22,5 x 45
2M = 45 x 45

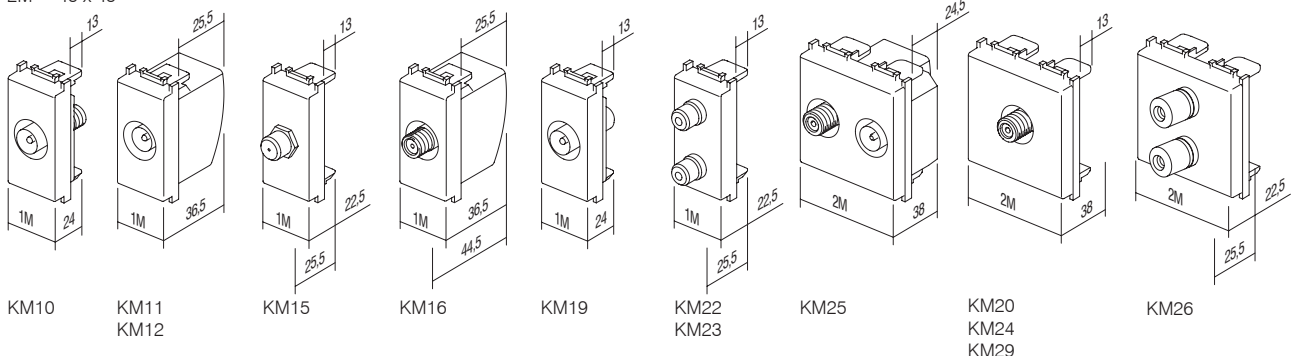

UTIČNICA TEL LT RJ11 6/4 1M

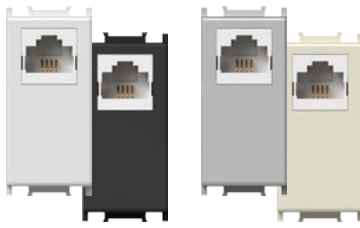

- KM30PW
- KM30SB
- KM30ES
- KM30IW

- TEL LT vijak
- RJ11 6/4
- sukladno normi IEC 60603-7
- vijčano pričvršćivanje

SOCKET TEL LT RJ11 6/4 1M

- TEL LT screw
- RJ11 6/4
- in accordance with IEC 60603-7
- screw contacts



UTIČNICA TEL BT SEC 6/6 1M

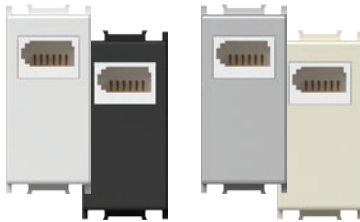

- KM31PW
- KM31SB
- KM31ES
- KM31IW

- TEL BT britanski standard
- SEC sekundarna 6/6
- sukladno normi BS 6312
- vijčano pričvršćivanje

SOCKET TEL BT SEC 6/6 1M

- TEL BT British standard
- SEC secondary 6/6
- in accordance with BS 6312
- screw contacts



UTIČNICA TEL KS RJ11 6/4 1M

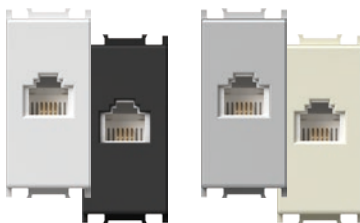

- KM36PW
- KM36SB
- KM36ES
- KM36IW

- KS keystone standard pričvršćivanja
- RJ11 6/4
- sukladno normi IEC 60603-7

SOCKET TEL KS RJ11 6/4 1M

- KS keystone fixing standard
- RJ11 6/4
- in accordance with IEC 60603-7



UTIČNICA CAT5e KS RJ45 8/8 1M

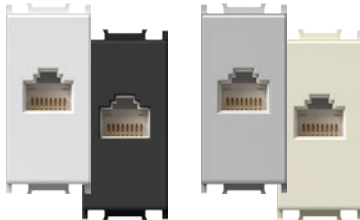

- KM37PW
- KM37SB
- KM37ES
- KM37IW

- KS keystone standard pričvršćivanja
- CAT5e, RJ45 8/8
- sukladno normi IEC 60603-7

SOCKET CAT5e KS RJ45 8/8 1M

- KS keystone fixing standard
- CAT5e, RJ45 8/8
- in accordance with IEC 60603-7



ADAPTER KS 1M

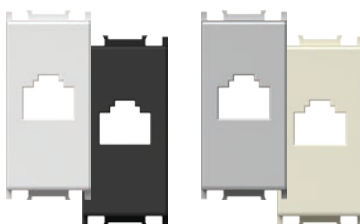

- KM35PW
- KM35SB
- KM35ES
- KM35IW

- KS keystone standard pričvršćivanja
- AMP, Avaya, Brandrex, FMT, Mfico, Tyco, ...
- nije ugrađen komunikacijski modul

ADAPTER KS 1M

- KS keystone fixing standard
- AMP, Avaya, Brandrex, FMT, Mfico, Tyco, ...
- communication module not included



ADAPTER KS SA ZAŠTITOM OD PRAŠINE 1M

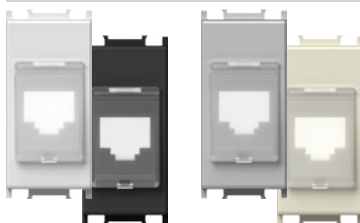

- KM38PW
- KM38SB
- KM38ES
- KM38IW

- KS keystone standard pričvršćivanja sa zaštitom od prašine
- AMP, Avaya, Brandrex, FMT, Mfico, Tyco, ...
- nije ugrađen komunikacijski modul

ADAPTER KS WITH DUST PROTECTION 1M

- KS keystone fixing standard with dust protection
- AMP, Avaya, Brandrex, FMT, Mfico, Tyco, ...
- communication module not included



ADAPTER KS UNIVERZALNI 1M

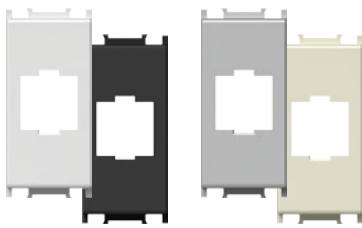

- KM50PW
- KM50SB
- KM50ES
- KM50IW

- KS keystone standard pričvršćivanja
- prikladan za HDMI, USB
- nije ugrađen komunikacijski modul

ADAPTER KS UNIVERSAL 1M

- KS keystone fixing standard
- suitable for HDMI, USB
- communication module not included



ADAPTER PD 1M

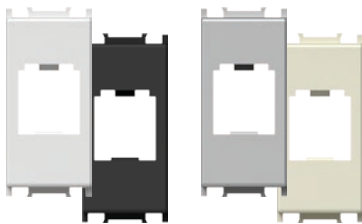

- KM40PW
- KM40SB
- KM40ES
- KM40IW

- PD Panduit Mini-COM standard pričvršćivanja
- nije ugrađen komunikacijski modul

ADAPTER PD 1M

- PD Panduit Mini-COM fixing standard
- communication module not included



ADAPTER PD SA ZAŠTITOM OD PRAŠINE 1M



- KM43PW
- KM43SB
- KM43ES
- KM43IW

- PD Panduit Mini-COM standard pričvršćivanja sa zaštitom od prašine
- nije ugrađen komunikacijski modul

ADAPTER PD WITH DUST PROTECTION 1M

- PD Panduit Mini-COM fixing standard with dust protection
- communication module not included



ADAPTER R&M 1M

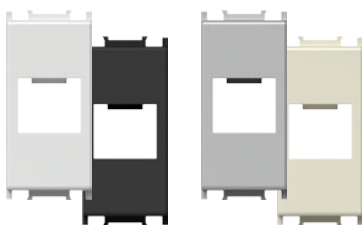

- KM46PW
- KM46SB
- KM46ES
- KM46IW

- R&M standard pričvršćivanja
- nije ugrađen komunikacijski modul

ADAPTER R&M 1M

- R&M fixing standard
- communication module not included



ADAPTER R&M SA ZAŠTITOM OD PRAŠINE 1M



- KM47PW
- KM47SB
- KM47ES
- KM47IW

- R&M standard pričvršćivanja sa zaštitom protiv prašine
- nije ugrađen komunikacijski modul

ADAPTER R&M WITH DUST PROTECTION 1M

- R&M fixing standard with dust protection
- communication module not included



ADAPTER LK 1M

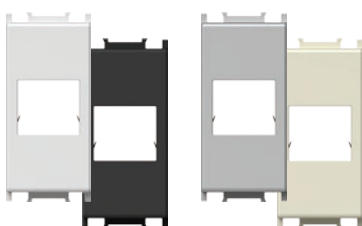

- KM45PW
- KM45SB
- KM45ES
- KM45IW

- LK LeoniKerpen eLine / BKS NewLine standard pričvršćivanja
- nije uključen komunikacijski modul

ADAPTER LK 1M

- LK LeoniKerpen eLine / BKS NewLine fixing standard
- communication module not included



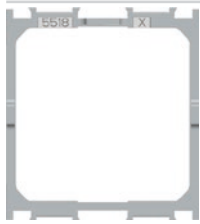

KA26

ADAPTER NEXANS/SCHRACK 2M

- pričvršćivanje adaptera za Nexans LANmark i module Schrack 45x45mm
- prikladno za tip Nexan N423.540N
- prikladno za tip Schrack HSEMD02W2F
- nije ugrađen komunikacijski modul

ADAPTER NEXANS/SCHRACK 2M

- fixing adapter for Nexans LANmark and Schrack module 45x45mm
- suitable for Nexans type N423.540N
- suitable for Schrack type HSEMD02W2F
- communication module not included

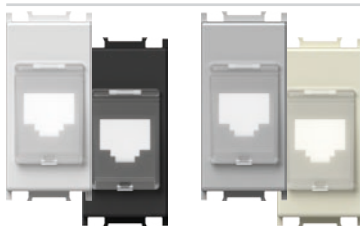
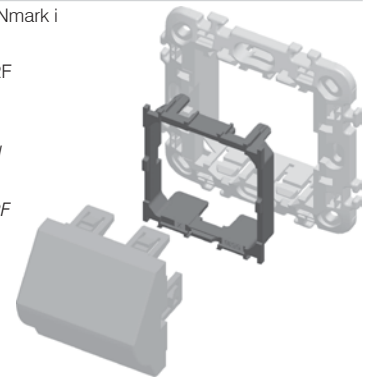

- KM48PW
- KM48SB
- KM48ES
- KM48IW

ADAPTER AT&T SYSTIMAX SA ZAŠTITOM OD PRAŠINE 1M

- AT&T Systimax standard pričvršćivanja sa zaštitom od prašine
- nije ugrađen komunikacijski modul

ADAPTER AT&T SYSTIMAX WITH DUST PROTECTION 1M

- AT&T Systimax fixing standard with dust protection
- communication module not included



- KM51PW
- KM51SB
- KM51ES
- KM51IW

UTIČNICA USB TIP A 1M

- USB 2.0 utičnica tip A
- vijčano pričvršćivanje, raster 5 mm, 1,5 mm², 1x2P + 1x3P
- spajanje:
 - PIN 1 – VCC (+5V, crvena žica)
 - PIN 2 – Data - (bijela žica)
 - PIN 3 – Data + (zeleno žica)
 - PIN 4 – GND - uzemljenje (crna žica)
 - S – zaštita
- sukladno direktivi 2011/95/EU (RoHS2)

SOCKET USB TYPE A 1M

- USB 2.0 socket type A
- screw contacts, raster 5 mm, 1,5 mm², 1x2P + 1x3P
- wiring:
 - PIN 1 – VCC (+5V, red wire)
 - PIN 2 – Data - (white wire)
 - PIN 3 – Data + (green wire)
 - PIN 4 – GND - ground (black wire)
 - S – shield
- in accordance with directive 2011/95/EU (RoHS2)



1M = 22,5 x 45
2M = 45 x 45

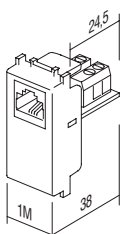

KM30

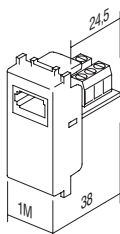

KM31

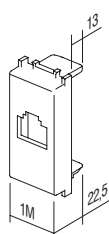

KM35
KM38
KM48

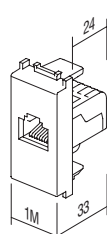

KM36
KM37

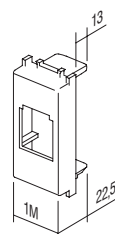

KM40
KM43

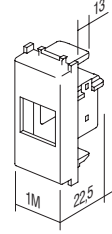

KM45

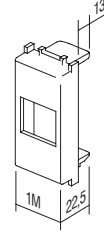

KM46
KM47
KM50

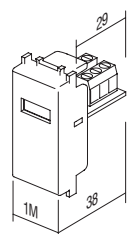

KM51



KA10

tip type	naziv description	tehnički podaci technical data
KA10	KONEKTOR KS CAT3 CONNECTOR KS CAT3	RJ11 6/4
KA11	KONEKTOR KS CAT5e CONNECTOR KS CAT5e	RJ45 8/8
KA12	KONEKTOR KS CAT5eS CONNECTOR KS CAT5eS	RJ45 8/8
...

KONEKTOR KS CAT3 RJ11 6/4



KA10

- KS keystone standard pričvršćivanja
- CAT3, RJ11 6/4
- sukladno normi IEC 60603-7

CONNECTOR KS CAT3 RJ11 6/4

- KS keystone fixing standard
- CAT3, RJ11 6/4
- in accordance with IEC 60603-7

KONEKTOR KS CAT5e RJ45 8/8



KA11

- KS keystone standard pričvršćivanja
- CAT5e, RJ45 8/8
- sukladno normi IEC 60603-7

CONNECTOR KS CAT5e RJ45 8/8

- KS keystone fixing standard
- CAT5e, RJ45 8/8
- in accordance with IEC 60603-7

KONEKTOR KS CAT5eS RJ45 8/8



KA12

- KS keystone standard pričvršćivanja
- CAT5eS, RJ45 8/8
- sukladno normi IEC 60603-7

CONNECTOR KS CAT5eS RJ45 8/8

- KS keystone fixing standard
- CAT5eS, RJ45 8/8
- in accordance with IEC 60603-7

KONEKTOR KS CAT6 SCH RJ45 8/8



KA15

- KS keystone standard pričvršćivanja
- CAT5e, RJ45 8/8
- sukladno normi ISO/IEC 11801

CONNECTOR KS CAT6 SCH RJ45 8/8

- KS keystone fixing standard
- CAT6 UTP toolless, RJ45 8/8
- in accordance with ISO/IEC 11801

KONEKTOR KS CAT6S SCH RJ45 8/8



KA16

- KS keystone standard pričvršćivanja
- CAT6S STP bezalatna montaža, RJ45 8/8
- sukladno normi ISO/IEC 11801

CONNECTOR KS CAT6S SCH RJ45 8/8

- KS keystone fixing standard
- CAT6S STP toolless, RJ45 8/8
- in accordance with ISO/IEC 11801

KONEKTOR KS CAT6S SCH RJ45 8/8



KA17

- KS keystone standard pričvršćivanja
- CAT6a STP bezalatna montaža, RJ45 8/8
- sukladno normi ISO/IEC 11801

CONNECTOR KS CAT6S SCH RJ45 8/8

- KS keystone fixing standard
- CAT6a STP toolless, RJ45 8/8
- in accordance with ISO/IEC 11801



KA27

KONEKTOR KS HDMI

- KS keystone standard pričvršćivanja
- samo u kombinaciji s adapterom KM50
- HDMI/HDMI

CONNECTOR KS HDMI

- KS keystone fixing standard
- only in combination with adapter KM50
- HDMI/HDMI



EM31



PW



tip type	naziv description	tehnički podaci technical data	veličina size	boja colour
EM10	REGULATOR OSVJETLJENJA ROTACIJSKI <i>DIMMER ROTATIVE</i>	R 300W	1M	<input type="checkbox"/> PW bijela sjajna <i>polar white</i>
EM11	REGULATOR OSVJETLJENJA ROTACIJSKI IZMJENIČNI <i>DIMMER ROTATIVE 2WAY</i>	RL 300W	1M	<input type="checkbox"/> SB crna mat <i>soft touch black</i>
EM21	REGULATOR OSVJETLJENJA UGRADNI <i>DIMMER INBOX</i>	RLC 300W	/	<input type="checkbox"/> ES srebrna mat <i>elox silver</i>
...	<input type="checkbox"/> IW bež sjajna <i>ivory white</i>
...	<input type="checkbox"/> BL plava <i>blue</i>
...	<input type="checkbox"/> RD crvena <i>red</i>
...	<input type="checkbox"/> GR zelena <i>green</i>
...	<input type="checkbox"/> OR narančasta <i>orange</i>
...	<input type="checkbox"/> RG crveno-zelena <i>red/green</i>

REGULATOR OSVJETLJENJA ROTACIJSKI R 300W 1M



- EM10PW
- EM10SB
- EM10ES
- EM10IW

- rotacijski bez sklopke
- tip RTS34, 43, RVP, opterećenje R, 40W – 300W
- mrežni napon 230V~ 50Hz
- nije moguća kombinacija s izmjeničnom sklopkom
- povezivanje više regulatora osvjetljenja nije dopušteno
- sukladno normi EN 60669-1
- vijčano pričvršćivanje vodiča presjeka 1,5-2,5mm²
- LED indikacija



DIMMER ROTATIVE R 300W 1M

- rotation control without switch
- type RTS34,43 RVP, load R, 40W - 300W
- supply voltage 230V~ 50Hz
- 2-way switch combination is not possible
- more dimmers combination is not allowed
- in accordance with EN 60669-1
- screw contacts 1.5-2.5mm²
- LED indication

REGULATOR OSVJETLJENJA ROTACIJSKI IZMJENIČNI RL 300W 1M

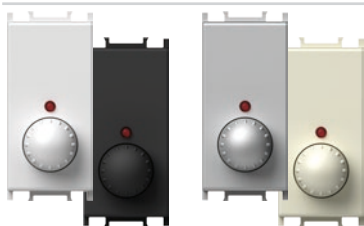

- EM11PW
- EM11SB
- EM11ES
- EM11IW

- rotacijski s izmjeničnom sklopkom
- tip RTS34 DVP, opterećenje RL, 40W – 300W
- mrežni napon 230V~ 50Hz
- moguća je kombinacija s izmjeničnom sklopkom
- povezivanje više regulatora osvjetljenja nije dopušteno
- memoriranje jačine osvjetljenja
- sukladno normi EN 60669-1
- vijčano pričvršćivanje vodiča presjeka 1,5-2,5mm²
- LED indikacija



DIMMER ROTATIVE 2WAY RL 300W 1M

- rotation control with 2-way switch
- type RTS34 DVP, load RL, 40W - 300W
- supply voltage 230V~ 50Hz
- 2-way switch combination is possible
- more dimmers combination is not allowed
- light intensity memory
- in accordance with EN 60669-1
- screw contacts 1.5-2.5mm²
- LED indication



EM21

REGULATOR OSVJETLJENJA UGRADNI RLC 300W

- ugradni, kontrola preko vanjskog tipkala
- tip RHUN, opterećenje RLC, 25W - 300W ili 25VA - 250VA
- mrežni napon 230V~ 50Hz
- moguće je nekoliko kombinacija tipkala
- povezivanje više regulatora osvjetljenja nije dopušteno
- memoriranje jačine osvjetljenja
- funkcija usporeni start / stop
- sukladno normi EN 61058-1
- vodiči presjeka 1,5 mm²



DIMMER INBOX RLC 300W

- inbox, controlled by external push button
- type RHUN, load RLC, 25W - 300W or 25VA - 250VA
- supply voltage 230V~ 50Hz
- several push-buttons combination is possible
- more dimmers combination is not allowed
- light intensity memory
- soft start / stop function
- in accordance with EN 61058-1
- wires 1.5mm²



EM22

REGULATOR OSVJETLJENJA UGRADNI R 500W

- ugradni, kontrola preko vanjskog tipkala
- tip RTL500UN, opterećenje R, 40W - 500W
- mrežni napon 230V~ 50Hz
- moguće je nekoliko kombinacija tipkala
- povezivanje više regulatora osvjetljenja nije dopušteno
- memoriranje jačine osvjetljenja
- funkcija usporeni start / stop
- sukladno normi EN 61058-1
- vijčano pričvršćivanje vodiča presjeka 1,5-2,5mm²



DIMMER INBOX R 500W

- inbox, controlled by external push button
- type RTL500UN, load R, 40W - 500W
- supply voltage 230V~ 50Hz
- several push-buttons combination is possible
- more dimmers combination is not allowed
- light intensity memory
- soft start / stop function
- in accordance with EN 61058-1
- screw contacts 1.5-2.5mm²

EM10 (40÷300W)
EM22 (40÷500W)

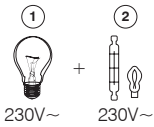

EM11 (40÷300W)

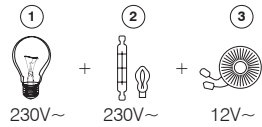

EM21 (25÷300W, 25÷250VA)

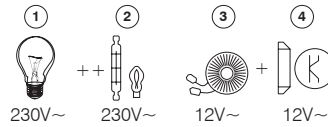

- 1 - žarulja sa žarnom niti / incandescent lamp
- 2 - halogena žarulja / halogen lamp
- 3 - klasični transformator / classical transformer
- 4 - elektronički transformator / electronic transformer

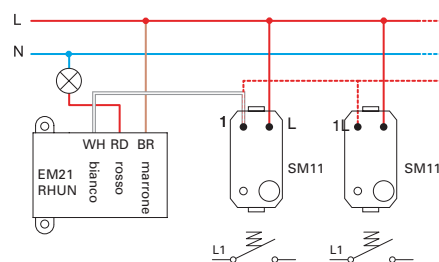
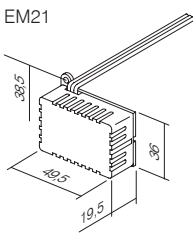
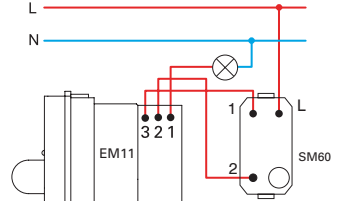
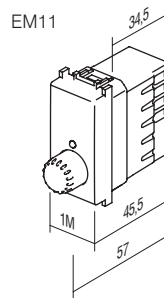
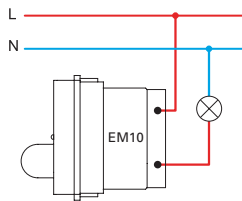
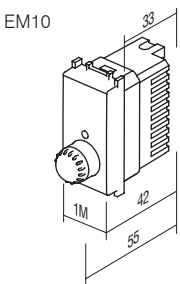

POZOR!

Ako se više regulatora osvjetljenja priključi u jednu kutiju, za svaki se dodatni regulator smanjuje maksimalna ukupna snaga za 10%.

ATTENTION!

If more dimmers are connected in one box reduce maximum common power for 10% for each dimmer.

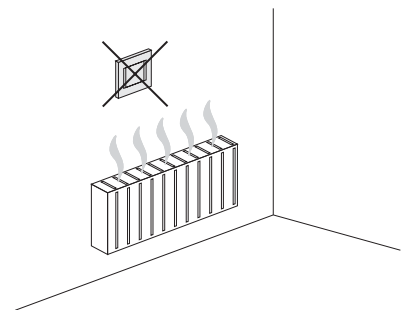
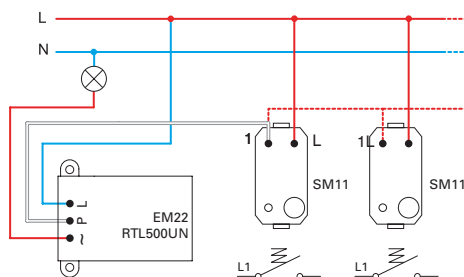
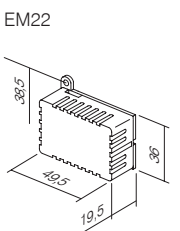

SKLOPKA / REGULATOR OSVJETLJENJA UNIVERZALNI RLC 0-300W 2M



- EM25PW
- EM25SB
- EM25ES
- EM25IW



TOUCH EM25 je mikroprocesorski upravljani zatamnivač svjetla. Služi kao sklopka te zatamnivač za zatamnjive i neke vrste nezatamnjivih žarulja. Ugrađeni mikroprocesor automatski prepoznaje vrstu žarulje i prilagođava način rada. Pamti razinu zatamnivanja nakon isključivanja, zahvaljujući ugrađenoj memorijskoj funkciji. Funkcija polaganog paljenja produžava vijek trajanja žarulje. U tipku integrirana elegantna LED rasvjeta omogućava razne boje i razine intenziteta. Moguće je spojiti do 5 dodatnih upravljačkih sklopki EM26 („slave“).

TOUCH EM25 is microprocessor controlled electronic light dimmer. It serves as switch and dimmer for dimmable and some of no-dimmable lamps. Integrated microprocessor automatically identifies the type of lamp and adjusts the operating mode. It remembers the level of dimming after switching off due to integrated memory function. Soft-start function extends the lamp service life. In button integrated elegant LED illumination enables many different colors and intensity levels. Optionally one can connect of up to 5 additional control tasters EM26 (slave).

- univerzalni elektronički regulator osvjetljenja za uključivanje i isključivanje i regulaciju osvjetljenja svih zatamnjivih žarulja (klasična, halogena, LED, CFL, ...) i nekih vrsta nezatamnjivih
- automatska detekcija tipa tinjalice i prilagodba režima rada
- smanjenje potrošnje energije
- funkcija usporenog starta produžuje vijek trajanja tinjalice
- kontrola preko ugrađene mikrosklopke
- ugrađena funkcija memorije – pri gašenju memorira stupanj svjetlosti
- može se priključiti do pet (5) dodatnih kontrolnih jedinica EM26
- nije moguće kombiniranje s izmjeničnom sklopkom
- ugrađena zaštita od kratkog spoja, pregrijavanja i preopterećenja
- mrežni napon 230V~ 50Hz
- elegantno LED osvjetljenje, prilagodljiva boja i stupanj osvjetljenja
- moguća zamjena klasične sklopke u dvožičnom spoju⁽¹⁾
- potpuna funkcionalnost postiže se u trožičnom spoju⁽²⁾
- sukladno normama EN 60669-1 i EN 60669-2-1
- vijčano pričvršćivanje vodiča presjeka 1,5 mm² (maks. moment zatezanja 0,4 Nm)

SWITCH / DIMMER UNIVERSAL RLC 0-300W 2M

- universal electronic dimmer for ON/OFF switching and dimming of all dimmable lamps (classical, halogen, LED, CFL, ...) and some no-dimmable lamps
- automatic detection of lamp type and adjustment of operating mode
- reduction of energy consumption
- soft start function extends life of lamps
- controlled by build-in micro switches
- memory function included – memorizes brightness on turn-off
- up to five (5) additional control units EM26 can be connected
- connection with 2-way switch is not possible
- build-in short-circuit, overheating and overload protection
- supply voltage 230V~ 50Hz
- elegant LED illumination, adjustable colour and brightness
- replacement of classical switch is possible at two-wire connection⁽¹⁾
- full functionality is achieved at three-wire connection⁽²⁾
- in accordance with EN 60669-1 and EN 60669-2-1
- screw contacts 1.5mm² (max. tightening torque 0.4Nm)

(1) dvožični spoj
two-wire connection

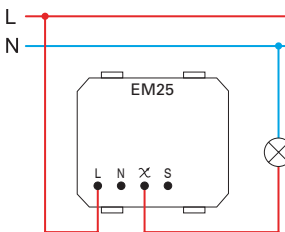

- dvožičano spajanje omogućava zatamnivanje zatamnjivih žarulja

- two-wire connection allows dimming of dimmable lamps

(2) Trožični spoj
three-wire connection

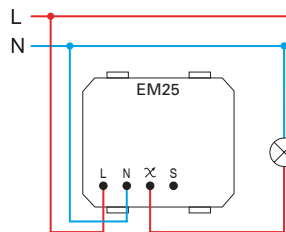

- trožičano spajanje omogućava zatamnivanje zatamnjivih žarulja te nekih nezatamnjivih LED i CFL lampi

- three-wire connection allows dimming of dimmable lamps and some of no-dimmable LED and CFL lamps

	12	5	6	7
Min.	40 W	40 W	40 VA	40 VA
Max.	300 W	300 W	300 VA	100 VA
	(F)	(F)		

1 - žarulja sa žarnom niti / incandescent lamp

2 - halogena žarulja / halogen lamp

4 - elektronički transformator / electronic transformer

5 - klasični transformator / classical transformer

	12	4	6	7	8	9
Min.	0 W	0 W	0 VA	0 VA	0 VA	0 VA
Max.	300 W	300 W	120 VA	120 VA	120 VA	120 VA
	(F)	(F)			(F)	(F)

6 - štedna CFL tinjalica s regulacijom osvjetljenja / dimmable energy saving CFL lamp

7 - LED tinjalica s regulacijom osvjetljenja / dimmable LED lamp

8 - štedna CFL tinjalica bez regulacije osvjetljenja / no-dimmable energy saving CFL lamp

9 - LED tinjalica bez regulacije osvjetljenja / no-dimmable LED lamp

napomene / remarks

- (F) filter EM27

- preporučujemo korištenje EM27 filtra / it is recommended to use filter EM27

- sve spojene žarulje moraju biti jednake / all controlled lamps must be the same

- tablica opterećenja vrijedi za žarulje s faktorom PF>0,5 / table of loads is valid for lamps with power factor PF>0.5

paljenje / gašenje te zatamnivanje žarulje /
on / off swithcing and dimming of lamp

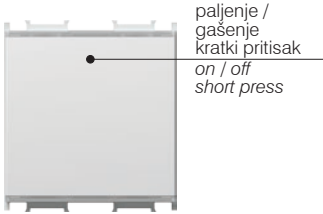

paljenje /
gašenje
kratki pritisak
on / off
short press

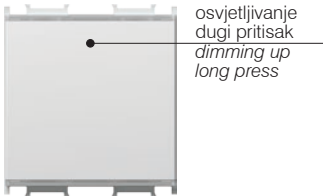

osvjetljivanje
dugi pritisak
dimming up
long press

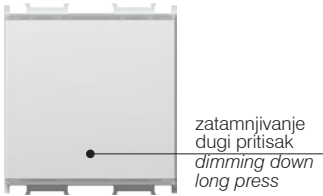

zatamnivanje
dugi pritisak
dimming down
long press

odabir boje i podešavanje intenziteta LED osvjetljenja /
LED colour selection and intensity level adjustment



isključivanje osvjetljenja
kratki pritisak
lamp off
short press

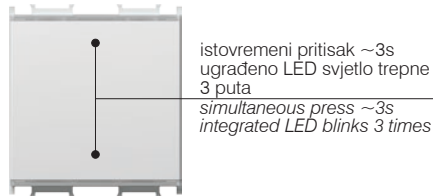

istovremeni pritisak ~3s
ugrađeno LED svjetlo trepne
3 puta
simultaneous press ~3s
integrated LED blinks 3 times



odabir boje
kratki pritisak
colour selection
short press

*funkcija "RESET" /
"RESET" function



isključivanje osvjetljenja
kratki pritisak
lamp off
short press

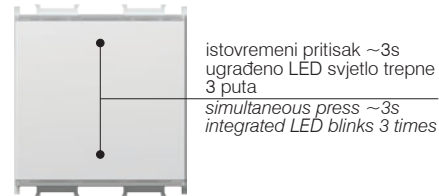

istovremeni pritisak ~3s
ugrađeno LED svjetlo trepne
3 puta
simultaneous press ~3s
integrated LED blinks 3 times



ponovni istovremeni pritisak ~5s
ugrađeno LED svjetlo trepne
5 puta
re-simultaneous press ~5s
integrated LED blinks 5 times

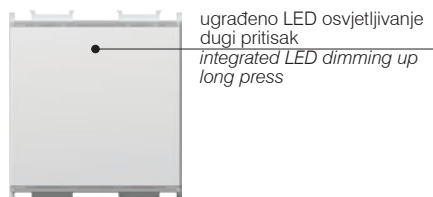

ugrađeno LED osvjetljivanje
dugi pritisak
integrated LED dimming up
long press

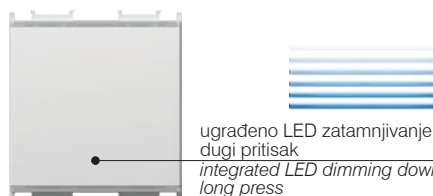

ugrađeno LED zatamnivanje
dugi pritisak
integrated LED dimming down
long press

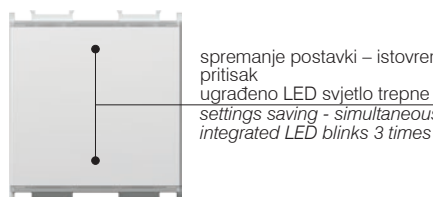

spremanje postavki – istovremeni kratki
pritisak
ugrađeno LED svjetlo trepne 3 puta
settings saving - simultaneous short press
integrated LED blinks 3 times

- * - preporučuje se za ugradnju zatamnivača i pri zamjeni žarulje
- obavezno kod korištenja nezatamnjivih žarulja
- funkcija "RESET" nije dostupna kod korištenja dvožičanog spajanja
- moguće samo za EM25
- it is recommended at dimmer installation and lamp replacement
- mandatory when using no-dimmable lamps
- "RESET" function is not possible when using two-wire connection
- only possible on EM25

upozorenja za ugradnju /
installation precautions

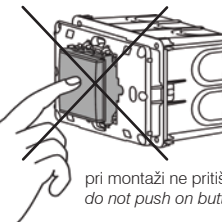
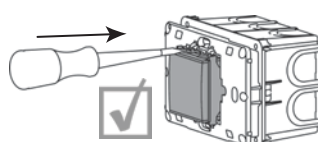
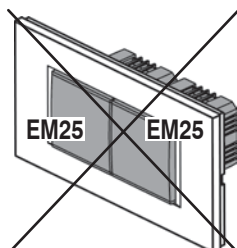
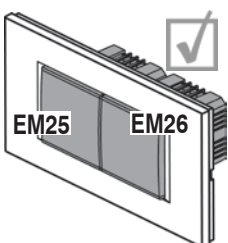

pri montaži ne pritišćite tipku /
do not push on button during mounting



- EM26PW
- EM26SB
- EM26ES
- EM26IW

UPRAVLJAČKA JEDINICA - TIPKALO 2M

- priključena na univerzalni regulator osvjetljenja dopušta upravljanje tinjalicama s istom funkcionalnošću kao EM25
- mrežni napon 230V~ 50Hz
- sukladno normama EN 60669-1 i EN 60669-2-1
- vijčano pričvršćivanje vodiča presjeka 1,5 mm² (maks. moment zatezanja 0,4 Nm)



PUSH-BUTTON CONTROL UNIT 2M

- connected to universal dimmer EM25 allows controlling of lamps with same functionality as EM25
- supply voltage 230V~ 50Hz
- in accordance with EN 60669-1 and EN 60669-2-1
- screw contacts 1.5mm² (max. tightening torque 0.4Nm)

(1) dvožični spoj
two-wire connection

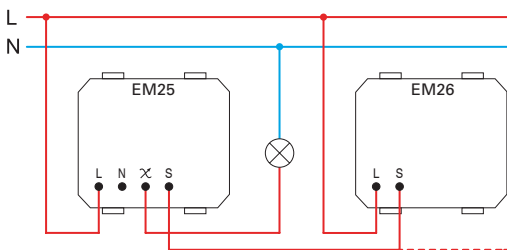

- dvožičano spajanje omogućava zatamnivanje zatamnjivih žarulja
- kod dvožičnog spajanja korištenje svake dodatne upravljačke jedinice povećava minimalno opterećenje za 25W

- two-wire connection allows dimming of dimmable lamps
- in a two-wire connection each additional control unit increases the minimum load by 25W

(2) Trožični trožični spoj
three-wire connection

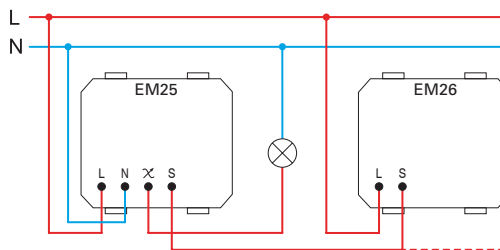

- trožičano spajanje omogućava zatamnivanje zatamnjivih žarulja te nekih nezatamnjivih LED i CFL lampi

- three-wire connection allows dimming of dimmable lamps and some of non-dimmable LED and CFL lamps

FREKVENCIJSKI FILTAR

EM27

- filtar frekvencijskih smetnji za EM25
- prikaz je simboličan

FREQUENCY FILTER

- frequency filter for EM25
- image is symbolic

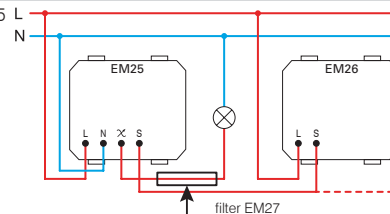

SET SKLOPKA / REGULATOR OSVJETLJENJA UNIVERZALNI RLC 0-300W 2M PP OL20

□ EM25PPOL20

- set uključuje regulator osvjetljenja EM25, ugradbeni nosač 2M i okvir LINE 2M PW
- za tehničke detalje pogledajte EM25

SET SWITCH | DIMMER UNIVERSAL RLC 0-300W 2M PP OL20

- set includes dimmer EM25, mounting frame 2M and cover plate LINE 2M PW
- for technical details see EM25



2M = 45 x 45

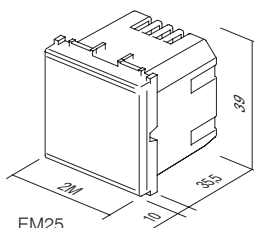

EM25
EM26



- EM31PW
- EM31SB
- EM31ES
- EM31IW

IR SKLOPKA 5A 230V~ 1M

- IR infracrvena sklopka
- napajanje: 230V~ ± 10% 50Hz
- relej: 5A / 250V~ izlaz za ograničeni strujni tok s velikim otporom za prolaz kroz ništicu („zero crossing“)
- zaštitna razina: IP40
- presjek žica na kontaktnom terminalu: 0,75 - 2,5 mm²
- kut prepoznavanja: do 110° pri 20 °C
- raspon prepoznavanja: približno 8m pri 20 °C
- prilagodljivost trajanja: od približno 5 s do 12 min
- prilagodljivost osvjjetljenja: od približno 5 do 200 LUX
- temperatura radnog okruženja: od 0 °C do +40 °C
- nije prikladan za ugradnju u kutije duboke 45 mm te podžbukne kutije CUBO IP20
- samo za unutrašnju uporabu



IR SWITCH 5A 230V~ 1M

- IR infrared switch
- supply voltage: 230V~ ± 10 % 50Hz
- relay: 5A / 250V~ output for limited current with high resistance for zero crossing
- protection rating: IP40
- cross-section of wires at the contact terminal: 0.75 - 2.5 mm²
- detection angle: up to 110° at 20°C
- detection area: approx. 8 m at 20°C
- adjustability of duration: from approx. 5 s to 12 min
- adjustability of brightness: from approx. 5 to 200 LUX
- operating temperature: from 0°C to +40°C
- not suitable for installation in 45 mm deep boxes and surface mount box CUBO IP20
- only for indoor usage



- EM32PW
- EM32SB
- EM32ES
- EM32IW

IR SKLOPKA 5A 230V~ 2M

- IR infracrvena sklopka
- napajanje: 230V~ ± 10% 50Hz
- relej: 5A / 250V~ izlaz za ograničeni strujni tok s velikim otporom za prolaz kroz ništicu („zero crossing“)
- zaštitna razina: IP40
- presjek žica na kontaktnom terminalu: 0,75 - 2,5 mm²
- kut prepoznavanja: do 110° pri 20 °C
- raspon prepoznavanja: približno 8m pri 20 °C
- prilagodljivost trajanja: od približno 5 s do 12 min
- prilagodljivost osvjjetljenja: od približno 5 do 200 LUX
- temperatura radnog okruženja: od 0 °C do +40 °C
- nije prikladan za ugradnju u kutije duboke 45mm te podžbukne kutije CUBO IP20
- samo za unutrašnju uporabu



IR SWITCH 5A 230V~ 2M

- IR infrared switch
- supply voltage: 230V~ ± 10 % 50Hz
- relay: 5A / 250V~ output for limited current with high resistance for zero crossing
- protection rating: IP40
- cross-section of wires at the contact terminal: 0.75 - 2.5 mm²
- detection angle: up to 110° at 20°C
- detection area: approx. 8 m at 20°C
- adjustability of duration: from approx. 5 s to 12 min
- adjustability of brightness: from approx. 5 to 200 LUX
- operating temperature: from 0°C to +40°C
- not suitable for installation in 45 mm deep boxes and surface mount box CUBO IP20
- only for indoor usage

mogućnost raspoznavanja
detection range

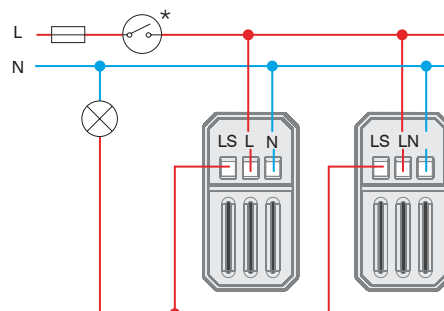
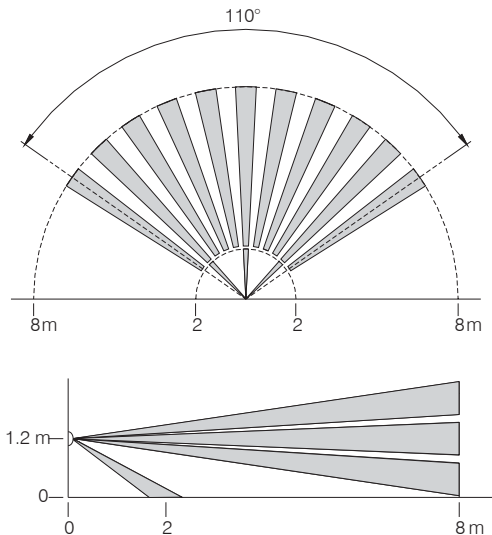

podešavanje vremena i osjetljivosti /
time and twilight adjustment

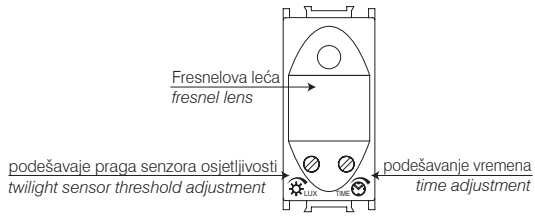

	~5 s	~12 min

	1	2	3	4	5	6	7	8
Min.	1 W	1 W		1 VA	1 W	1 W	1 VA	1 VA
Max.	800 W	800 W	5A	6x20 VA	6x36 W	4x36 W (20µF)	6x23 VA	6x20 VA

1 - žarulja sa žarnom niti /
incandescent lamp

2 - halogena žarulja /
halogen lamp

3 - otporan grijaći element /
resistive heating element

4 - elektronički transformator /
electronic transformer

5 - fluorescentna cijev (izvedba 1) /
fluorescent tube (version 1)

6 - fluorescentna cijev (izvedba 2) /
fluorescent tube (version 2)

7 - štedna CFL žarulja /
energy saving CFL lamp

8 - LED žarulja /
LED lamp

upozorenja /
attention

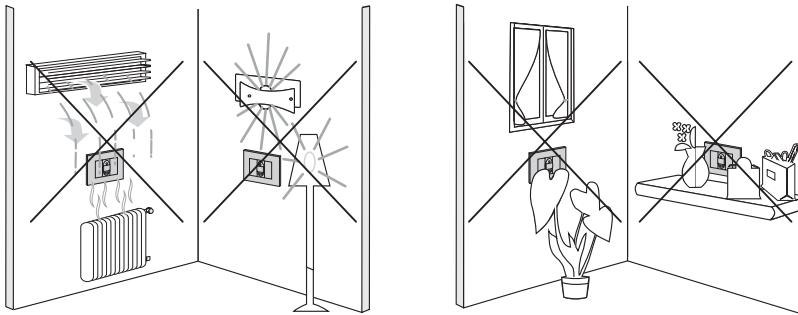

1M = 22,5 x 45

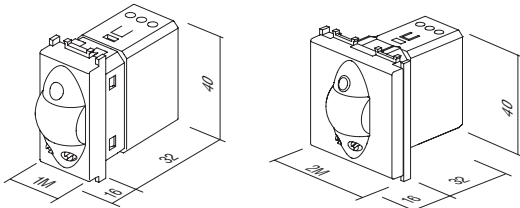



- EM37PW
- EM37SB
- EM37ES
- EM37IW

TERMOSTAT OSNOVNI 6A 230V~ 2M

- elektronički termostat, osnovni
- način rada: grijanje / hlađenje / isključeno
- napajanje: 230 VAC, 50 Hz
- izlaz: 6(2) A, 230 VAC, relejna sklopka
- raspon regulacije: +10 °C do +30 °C
- histereza: ±0.5 °C, ED = 20min
- zaštita protiv smrzavanja (način grijanja): +6 °C
- zaštita protiv pregrijavanja (način hlađenja): +32 °C
- funkcija ECO za snižavanje temperature za 3 °C za 6 sati u načinu grijanja te povećanja temperature za 3 °C za 6 sati u načinu hlađenja
- prilagođena ECO funkcija, svaki dan automatski u isto vrijeme snižava temperaturu za 3 °C unutar 6 sati u načinu grijanja te povećava temperaturu za 3 °C unutar 6 sati u načinu hlađenja
- mogućnost uključivanja ECO funkcije vanjskim okidačem putem odvojenog unosa LED indikator načina rada
- nije prikladan za električno podno grijanje
- vijčano pričvršćivanje vodiča presjeka maks. 2.5 mm²
- sukladno s LV Direktivom, EMC Direktivom, standardima EN60730-1 te EN60730-2-9
- za pravilno korištenje preporučujemo instaliranje u zasebnu kutiju, odvojenu od uređaja koji stvaraju toplinu
- temperatura korištenja: 5 ÷ 35 °C
- temperatura skladištenja: -20 ÷ 50 °C



Termostat je namijenjen reguliranju temperature u prostoru. Termostat omogućava dva načina rada – grijanje ili hlađenje. Ugrađene su i sigurnosne funkcije protiv smrzavanja (način grijanja) te protiv pregrijavanja (način hlađenja). Način rada se označava preko LED osvjjetljenja. Postavke termostata unose se pomoću okretnog mehanizma za postavljanje temperature te s drugim kapacitivnim dodirnim tipkama.

The thermostat is intended for regulating temperature in a room. A thermostat enables two modes of operation – heating or cooling. It has safety functions installed for protection against freezing (heating mode) and protection against overheating (cooling mode). The operation is indicated via LED lights. Thermostat setup is performed with the help of a rotary button for setting the temperature and with other capacitive touch buttons.

THERMOSTAT BASIC 6A 230 V ~ 2M

- electronic thermostat, basic
- operation mode: heating/cooling/turn off
- power supply: 230 VAC, 50 Hz
- output: 6(2) A, 230 VAC, relay switch
- regulation range: +10 °C to +30 °C
- hysteresis: ±0.5 °C, ED = 20min
- anti-freeze protection (heating mode): +6 °C
- overheating protection (cooling mode): +32 °C
- ECO function for lowering the temperature by 3 °C for 6 hours in the heating mode and raising temperature by 3 °C for 6 hours in the cooling mode
- adaptive ECO function, automatically every day at the same time lowers the temperature by 3 °C for 6 hours in the heating mode and raises temperature by 3 °C for 6 hours in the cooling mode
- option to turn on the ECO operating mode by external trigger via a separate input
- LED indication of operation
- not suitable for electrical floor heating
- screw contacts max. 2.5 mm²
- in accordance with the LV Directive, the EMC Directive, standards EN60730-1 and EN60730-2-9
- for correct operation, we recommend installing in an independent single box, separate from devices that generate heat
- operating temperature: 5 ÷ 35 °C
- storage temperature: -20 ÷ 50 °C

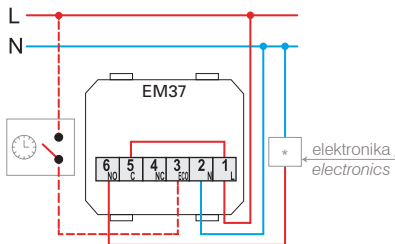

circulacijska crpka, plamenik (direktno spajanje)
termoelektrični pogon /
circulation pump, burner (direct connection)
thermoelectric drive

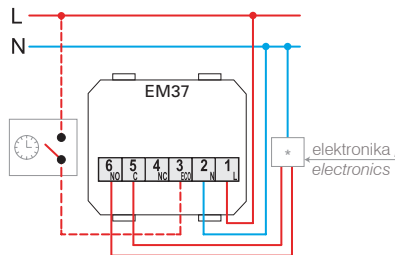

bojler, toplinska crpka, plamenik (upravljački unos T1/T2) /
boiler, heat pump, burner (control input T1/T2)

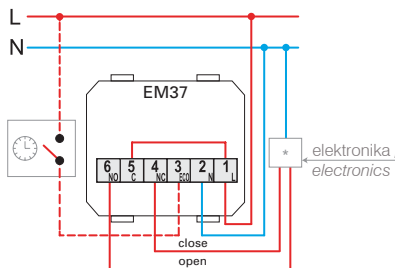

motorni pogon (ograničena uporaba s podnim grijanjem) /
motor drive (limited use with underfloor heating)

2M = 45 x 45

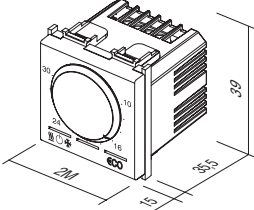

postavljanje načina rada i temperature /
function and temperature adjustment

tipka za izbor načina rada i LED indikator stanja:
crvena: grijanje
plava: hlađenje
ne svijetli: isključeno

function selection button and LED status indicator:
red: heating
blue: air conditioning
no light: switched off

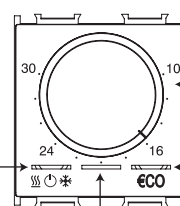

postavljanje temperature
temperature setting

tipka za izbor "ECO" načina i LED indikator "ECO" načina
zeleno: ECO ušteda energije UKLJUČENA
narančasta: aktiviran prilagođeni ECO način
ne svijetli: dnevni način

"ECO" function selection button and LED "ECO" status indicator
green: ECO energy saving ON
orange: adaptive ECO mode activated
no light: day mode

LED indikator stanja izlaznog releja
bijela: relej uključen
ne svijetli: relej isključen

LED output relay state indicator
white: relay ON
no light: relay OFF

upozorenja /
attention

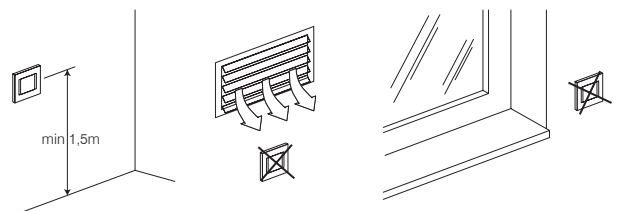



- EM40PW
- EM40SB
- EM40ES
- EM40IW

ŠTEDNA KARTIČNA SKLOPKA 3A 250V~ 3M

- osnovna kartična sklopka, za bilo koju ISO karticu
- mrežni napon 230V~ 50Hz
- izlaz: 3A 250V~ za sklopnik*
- zadržka isklopa 15-20s
- sukladno normi EN 61000-6-1
- kartica nije priložena
- nije za kontrolu pristupa



ENERGY SAVER CARD SWITCH 3A 250V~ 3M

- card switch basic, any ISO card
- supply voltage 230V~ 50Hz
- output 3A 250V~ for switching contactor *
- switch off delay 15-20s
- in accordance with EN 61000-6-1
- card is not included
- not for access control

3M = 67,5 x 45

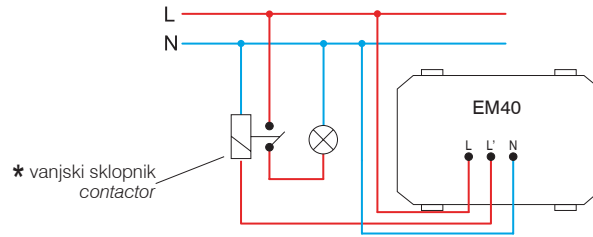
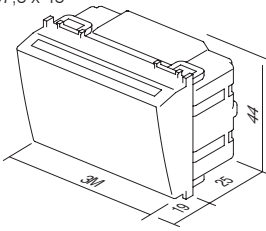

KARTICA ISO



EM47

- ISO kartica
- za uporabu s kartičnom sklopkom EM40
- veličina: 85x54 mm

CARD ISO

- ISO card
- for combination with card switch EM40
- size: 85x54 mm



EM44BK

ŠTEDNA KARTIČNA SKLOPKA RF HF 13,56MHz 3M

- kartična sklopka elektronska za RFID ISO karticu
- napajanje iz relejne jedinice EM49 putem kablovskih konektora RJ12
- izlaz treba biti spojen na relejni izlaz EM49
- 15-20s zadržka isklapa „glavnog napajanja” s povlačenjem kartice
- 1 min zadržka isklapa „HVAC” s povlačenjem kartice prilikom otvaranja balkonskih vrata ili prozora
- sukladno normi EN 61000-6-1
- kartica nije priložena
- nije za kontrolu pristupa

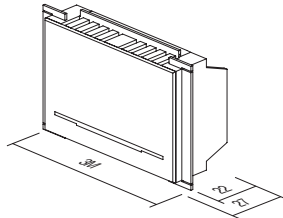

ENERGY SAVER CARD SWITCH RF HF 13,56MHz 3M

- electronic card switch for RFID ISO card
- supply from relay unit EM49 through cable connectors RJ12
- output to be connected to relay output unit EM49
- 15-20s "main power" switch off delay with card withdrawal
- 1 min "HVAC" switch off delay with card withdrawal when balcony doors or windows opened
- in accordance with EN 61000-6-1
- card is not included
- not for access control



EM49

ŠTEDNA KONTROLNA JEDINICA 2x16A 250V~

- relejna jedinica za kartične sklopke EM44
- mrežni napon 230V~ 50Hz
- sukladno normi EN 61000-6-1
- montaža na DIN tračnicu 35 mm, 4MU
- ulaz i izlaz ovisno o primjeni: jednokrevetna ili dvokrevetna soba

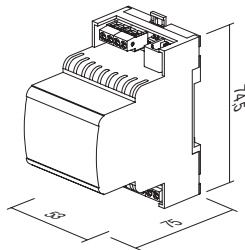

ENERGY SAVER CONTROL UNIT 2x16A 250V~

- relay unit for card switches EM44
- supply voltage 230V~ 50Hz
- in accordance with EN 61000-6-1
- mounting on DIN rail 35mm, 3MU
- input and output depending on implementation: single or double room



EM45

RAZDVAJAČ SPL-1

- koristi se za spajanje dva periferna modula EM44 s relejnom jedinicom EM49
- komunikacijski konektor RJ12
- veličina: 37 x 30 x 27 mm

SPLITTER SPL-1

- used to connect two peripheral modules EM44 to relay unit EM49
- communication connector RJ12
- size: 37 x 30 x 27 mm

dijagram spajanja za primjenu u jednokrevetnoj sobi / wiring diagram for single room implementation

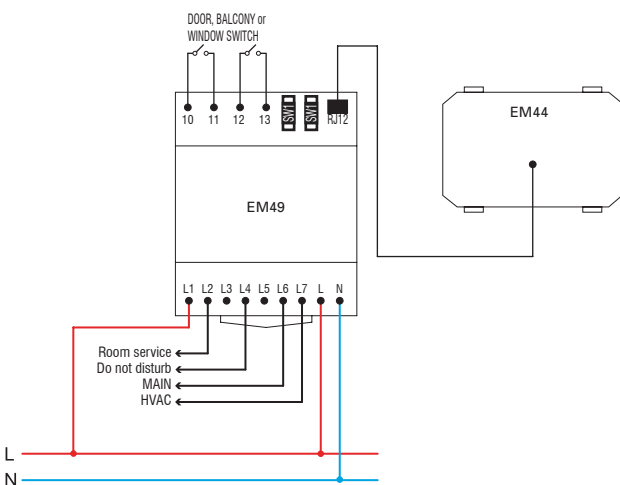

dijagram spajanja za primjenu u dvokrevetnoj sobi / wiring diagram for double room implementation

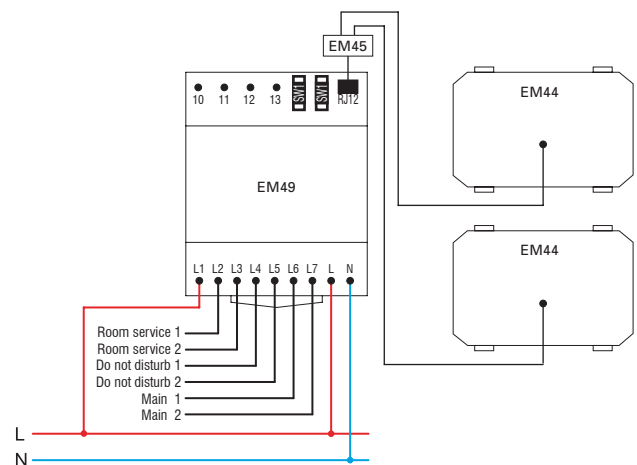

priključni kabel RJ12 između EM44 i EM49 / connection cable RJ12 between EM44 and EM49

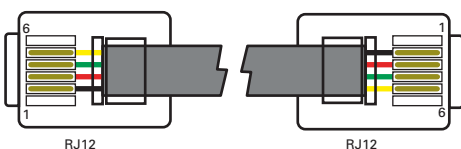



- EM60PW
- EM60SB
- EM60ES
- EM60IW

UTIČNICA ZA BRIJAČI APARAT 230V~/125V~ 3M

- utičnica za brijači aparat s izolacijskim transformatorom 20VA
- napajanje: 230V~ 50-60Hz
- izlaz: 230V~ za 2P 2,5A euro utikač ili 125V~ za 2P 15A američki utikač
- razred II
- sukladno normi EN 61558-2-5



SOCKET SHAVER 230V~/125V~ 3M

- shaver supply unit with isolating transformer 20VA
- supply: 230V~ 50-60Hz
- output: 230V~ for 2P 2.5A Europlug or 125V~ for 2P 15A American plug
- Class II
- in accordance with EN 61558-2-5

3M = 67,5 x 45

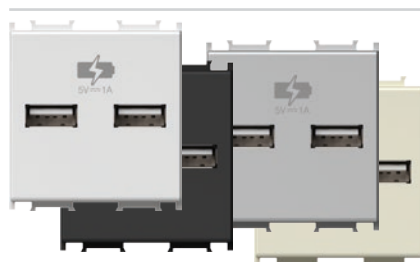
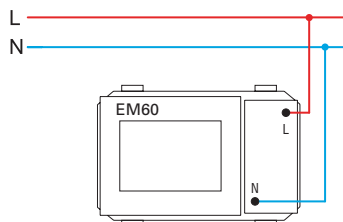
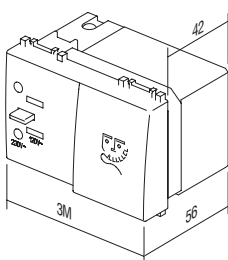

- EM65PW
- EM65SB
- EM65ES
- EM65IW

JEDINICA NAPAJANJA USB 5V 1A 2M

- za punjenje elektroničkih uređaja putem standardnog USB priključka (sukladno i s Apple uređajima)
- omogućava istovremeno punjenje dva uređaja
- napajanje: 230V~ 50Hz
- potrošnja pri mirovanju: 50 mW pri 230V~
- nazivni izlazni napon: 5 VDC (±5%) SELV
- njihanje (ripple) izlaznog napona: 150 mV
- nazivna izlazna snaga: 1A (1x 1.000mA ili 2 x 500mA) (±10%)
- učinkovitost: veća od 67%
- IP zaštitni razred: IP20, samo za unutrašnju uporabu
- vijčano pričvršćivanje vodiča presjeka maks. 2,5 mm²
- sukladno standardu EN 60950-1 te EMC direktivi
- kao dio instalacije potrebno je uzeti u obzir odgovarajući vanjski uređaj za isključivanje



2M = 45 x 45

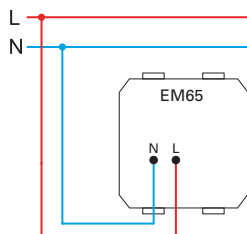
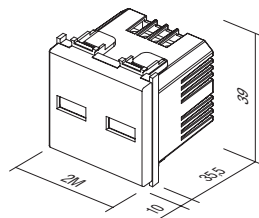

POWER SUPPLY UNIT USB 5V 1A 2M

- for charging of electronic devices via a standard USB port (also compatible with Apple devices)
- enables charging of two devices simultaneously
- power supply: 230V~ 50Hz
- stand-by power consumption: 50 mW at 230V~
- nominal output voltage: 5 VDC (±5%) SELV
- output ripple voltage: 150 mV
- nominal output current: 1 A (1 x 1.000 mA or 2 x 500 mA) (±10%)
- efficiency: greater than 67%
- IP protection class: IP20, indoor use only
- screw contacts: max. 2.5 mm²
- in accordance with EN 60950-1 and EMC directive
- an appropriate external disconnect device needs to be considered as part of installation



- EM55

LED SVJETILKA ZA SLUČAJ NUŽDE 250V~ 1.5W, Ni-Mh 6h 7M

- LED svjetiljka za slučaj nužde
- mrežni napon 230V~ 50Hz 3x0,5W LED svjetiljke E10, zamjenjive
- NiMh akumulator 1150 mAh, zamjenjiv
- autonoman rad 6 h, punjenje 4 h
- razred II
- osvjetljenje 76lx / 0,9m²
- sukladno normama EN 60598-1, EN 60598-2-2, EN 60598-2-22



LED EMERGENCY LIGHT 250V~ 1.5W, Ni-Mh 6h 7M

- emergency LED lamp
- supply voltage 230V~ 50Hz 3x0.5W LED lamps E10, replaceable
- NiMh accumulator 1150 mAh, replaceable
- autonomy 6h, charging 4h
- Class II
- in accordance with EN 60598-1, EN 60598-2-2, EN 60598-2-22
- illumination 76lx / 0,9m²

7M = 151,5 x 45

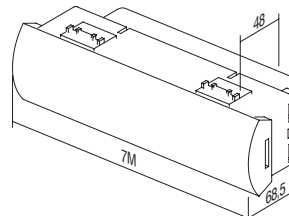
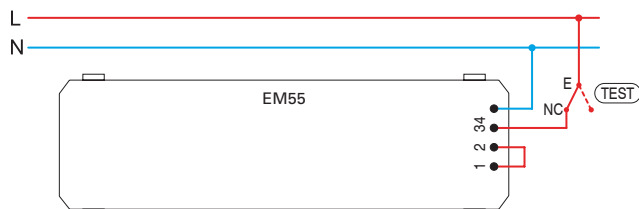

LED SVJETILJKA JEDNOBOJNA 250V~ 0,8W 2M

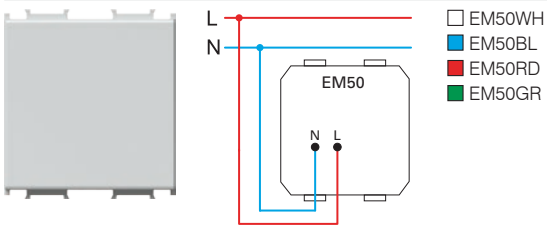

- LED svjetiljka za označavanje stepenica
- mrežni napon 230V~ 50Hz 0,8W
- razred II
- sukladno normi EN 60598-1
- opcionalna uporaba za osvijetljavanje pravca ili signaliziranje s laserskom gravurom na difuzeru prema želji korisnika

LED LAMP MONOCOLOR 250V~ 0,8W 2M

- step marker LED lamp
- supply voltage 230V~ 50Hz 0,8W
- Class II
- in accordance with EN 60598-1
- optional usage for directional or signal illumination with customized laser printing on diffuser



LED SVJETILJKA DVOBOJNA 250V~ 2x0,4W 2M

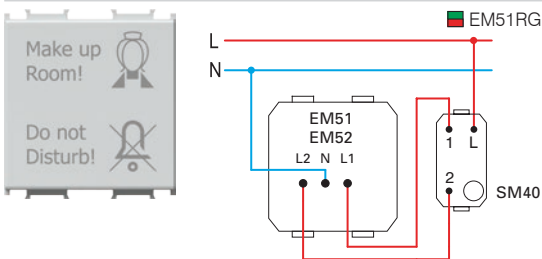

- LED svjetiljka s dvobojnom signalizacijom (crveno/zelenom)
- mrežni napon 230V~ 50Hz 2x0,4W
- razred II
- sukladno normi EN 60598-1
- difuzer obuhvaća i grafiku prema prikazu
- moguć laserski otisak na difuzeru prema želji korisnika

LED LAMP DUAL COLOR 250V~ 2x0,4W 2M

- signaling dual color (red/green) LED lamp
- supply voltage 230V~ 50Hz 2x0,4W
- Class II
- in accordance with EN 60598-1
- diffuser includes graphics as shown
- possible customized laser printing on diffuser



LED SVJETILJKA 3D DVOBOJNA 250V~ 2x0,4W 2M

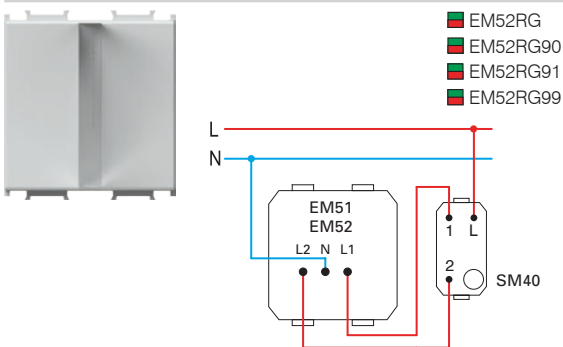

- LED dvobojna svjetiljka (crvena/zelena) s 3D simbolom, za označavanje
- mrežni napon 230V~ 50Hz 2x0,4W
- razred II
- sukladno normi EN 60598-1
- mogućnost otiska prilagođenih grafika po želji
- 90 muških simbola, 91 ženski simbol, 99 simbola na zahtjev

LED LAMP 3D DUAL
COLOR 250V~ 2x0,4W 2M

- signalling LED lamp, dual color (red/green) with 3D symbol
- supply voltage 230V~ 50Hz 2x0,4W
- class II
- in accordance with EN 60598-1
- possible customized graphics on request
- 90 male symbol, 91 female symbol, 99 symbol on request

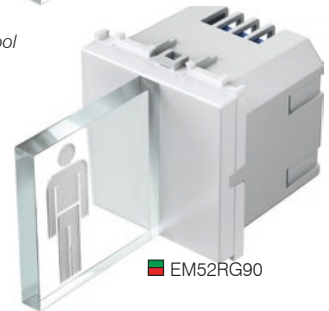

2M = 45 x 45

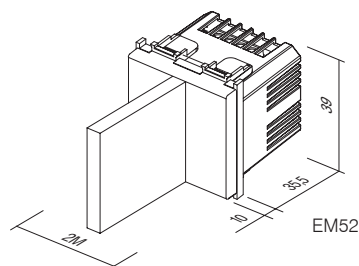
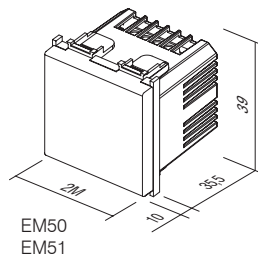

SKLOPKA NA OTISAK PRSTA ARX ONE 2M



- EM70PW
- EM70SB
- EM70ES
- EM70IW

- sklopka na otisak prsta s ugrađenom internom relejnom jedinicom
- za otključavanje električnih brava
- kapacitet 1000 otisaka prstiju
- jednostavno programiranje s dvjema tipkama
- toplinski biometrijski senzor
- napajanje 110-230V~ 50-60Hz preko interne relejne jedinice
- izlazni relej 2x3A 12V DC
- 256-bitna enkriptirana veza između sklopke i interne relejne jedinice
- sukladno normi EN 61000-6-1

FINGERPRINT SWITCH ARX ONE 2M

- fingerprint switch with included internal relay unit
- for unlocking electrical locks
- capacity 1000 fingerprints
- easy programming with two buttons
- thermal biometric sensor
- internal relay unit supply 110-230V~ 50-60Hz
- output relay 2x3A 12V DC
- 256-bit encrypted link between switch and internal relay unit
- in accordance with EN 61000-6-1



REGISTRACIJA OVLAŠTENE OSOBE

1. Prva tri otiska prsta pri registraciji dobivaju upravljačka prava.
2. Postupak registracije ovlaštene osobe isti je kao kod registracije korisnika bez drugog koraka.

ADMINISTRATOR ENROLMENT

1. The first three fingerprints enrolled are assigned administrative rights.
2. Administrator enrolment procedure is same as user enrolment without second step.

REGISTRACIJA KORISNIKA

1. Lijevu tipku na vanjskoj jedinici pritisnuti u trajanju od 3 sekunde. Narančasto LED svjetlo trepti sporom brzinom.
2. Ovlaštena osoba treba jedanput lupnuti prstom po senzoru. Nakon što je identificirana, narančasto LED svjetlo početi će brzo bljeskati.
3. Pritisnuti lijevu tipku. Zeleno LED svjetlo daje potvrdu.
4. Narančasto i zeleno svjetlo bljeskat će naizmjenično. U tom trenutku korisnik mora četiri puta lupnuti prstom po senzoru. Svaki uspješan ulaz potvrđuje se zvučnim signalom.
5. Nakon što je korisnik propisno registriran, bljeskat će zeleno LED svjetlo, a zvonice će istovremeno proizvoditi zvuk.

USER ENROLMENT

1. The left button on the exterior unit is pressed for 3 seconds. The orange LED starts flashing slow.
2. An administrator swipes his finger over the sensor once. When he/she is identified, the orange LED will start flashing fast.
3. Press left button. The green LED confirms.
4. The orange and green LED will flash alternately. At this point the user swipes his/her finger over the sensor four times. Each successful entry is indicated by a buzz.
5. When the user is correctly enrolled, the green LED will flash and the buzzer will buzz at the same time.

BRISANJE KORISNIKA

1. Pritisnuti desnu tipku na vanjskoj jedinici u trajanju od 5 sekundi, nakon čega će početi sporo bljeskati narančasto LED svjetlo.
2. Ovlaštena osoba treba jedanput lupnuti prstom po senzoru. Nakon što je identificirana, bljeskat će zeleno LED svjetlo, a zvonice će istovremeno proizvoditi zvuk.
3. Crveno i zeleno LED svjetlo bljeskat će naizmjenično. Zatim će korisnik jedanput lupnuti prstom po senzoru. Kad je korisnik bude identificiran, bljeskat će zeleno LED svjetlo, a će se oglasiti zvučnim signalom. Korisnik je uspješno izbrisan iz sustava.

DELETING A USER

1. The right button on the exterior unit should be pressed for 5 seconds whereupon the orange LED will start flashing slow.
2. An administrator swipes his finger over the sensor once. When he/she is identified, the green LED will flash and the buzzer will buzz at the same time.
3. The red and green LED will flash alternately. Then the user swipes his finger over the sensor once. When the user is identified, the green LED flash and the buzzer will buzz once. The user has been successfully deleted from the system.

BRISANJE SVIH OTISAKA PRSTIJU

1. Pritisnite zajedno lijevu i desnu tipku na vanjskoj jedinici u trajanju od 10 sekundi, nakon čega će narančasto i crveno LED svjetlo bljeskati naizmjenično.
2. Ovlaštena osoba zatim lupnuti jedanput prstom. Identifikacija je potvrđena kada bljesne zeleno LED svjetlo, a zvonice istovremeno proizvode zvuk. Narančasto i crveno LED svjetlo opet će naizmjenično bljeskati. Ovlaštena osoba ponavlja drugi korak.
4. Crveno i narančasto LED svjetlo bljeskat će, a zvonice će istovremeno pet puta proizvesti zvuk. Svi predložci otisaka prstiju bit će zatim izbrisani.

DELETING ALL FINGERPRINTS

1. Press the left and right button on the exterior unit together for a period of 10 seconds whereupon the orange and red LED will flash alternately.
2. The administrator then swipes his/her finger once. Identification is confirmed when the green LED flashes and the buzzer buzzes at the same time.
3. The orange and red LED will flash alternately again. The administrator repeats second step.
4. The red and orange LED will flash and the buzzer will buzz five times simultaneously. All fingerprint templates will then have been deleted.

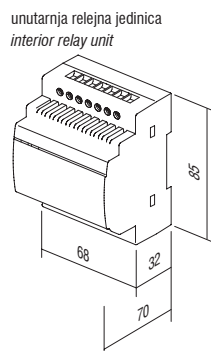
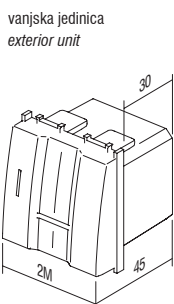
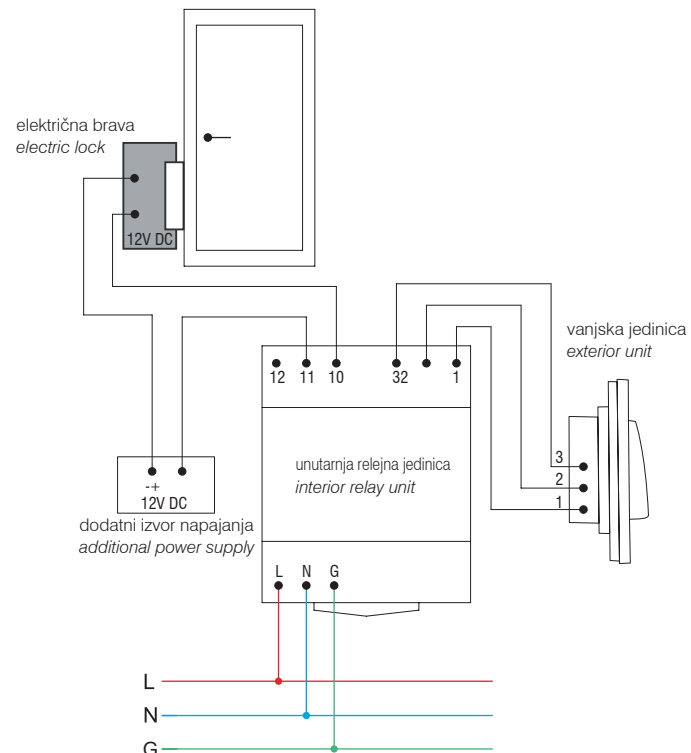
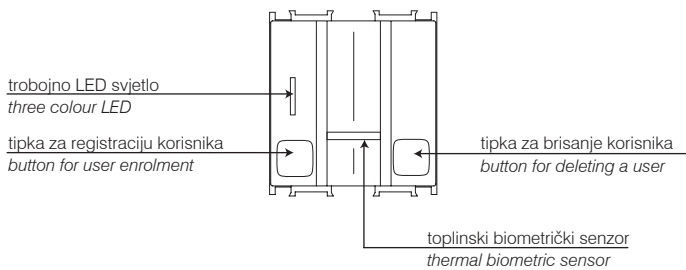
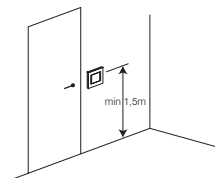

SKLOPKA, BESKONTAKTNA 10A 240V~



■ EM80GW

- beskontaktna sklopka za uključivanje i isključivanje („glavna“)
- napajanje: 240 V~ 50 Hz
- izlazni relej 10A / 250V~ (2400W pri 240V~)
- prilagodljivi raspon od 2 do 10 cm
- namijenjeno za ugradnju u standardnu okruglu kutiju Ø60 mm
- neutralan kabel (N) je potreban za spajanje
- nije moguće kombiniranje polužnom sklopkom
- moguće je povezivanje s do 5 EM81 upravljačkih sklopki
- jednostavna ugradnja dekorativnih poklopaca uz pomoć magneta
- vijčano pričvršćivanje kabela do 2.5 mm² (maks. vijčani moment zatezanja 0.4 Nm)
- sukladno normama EN 60669-1 i EN 60669-2-1
- samo za unutrašnju uporabu



SWITCH, TOUCHLESS 10A 240V~

- touchless switch for turning on/off ("master")
- power supply: 240 V~ 50 Hz
- output relay 10A / 250V~ (2400W at 240V~)
- adjustable range from 2 to 10 cm
- intended for installation into a standard round Ø60 mm box
- a neutral lead (N) is required for connection
- connection with toggle switches is not possible
- connection with up to 5 EM81 control switches is possible
- simple installation of decorative covers with the help of magnets
- screw fastening of leads up to 2.5 mm² (max. screw tightening torque is 0.4 Nm)
- in accordance with EN 60669-1 and EN 60669-2-1
- only for indoor use

SKLOPKA, BESKONTAKTNA, UPRAVLJAČKA JEDINICA



■ EM81GW

- upravljačka sklopka ("slave")
- radi samo kad je spojena sa sklopkom EM80 („glavna“)
- jednostavna ugradnja dekorativnih poklopaca uz pomoć magneta
- vijčano pričvršćivanje kabela do 2.5 mm² (maks. vijčani moment zatezanja 0.4 Nm)
- sukladno normama EN 60669-1 i EN 60669-2-1
- samo za unutrašnju uporabu



SWITCH, TOUCHLESS, CONTROL UNIT

- control switch ("slave")
- works only when connected with the EM80 switch ("master")
- simple installation of decorative covers with the help of magnets
- screw fastening of leads up to 2.5 mm² (max. screw tightening torque is 0.4 Nm)
- in accordance with EN 60669-1 and EN 60669-2-1
- only for indoor use

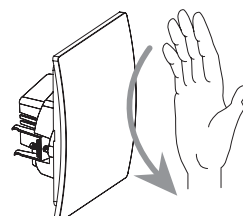
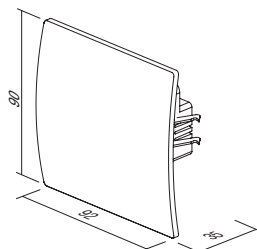
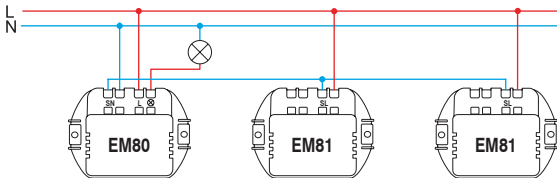
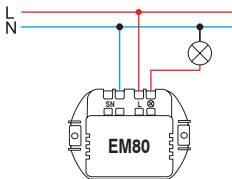

ZVONO 8VA 230V~ 1M

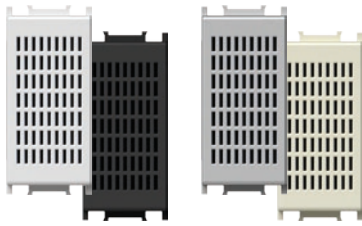

- EM90PW
- EM90SB
- EM90ES
- EM90IW

- signalno zvono
 - emisija zvuka traje vremenski jednako kao i postupak posluživanja
 - mrežni napon 230V~ 50Hz 8VA

BUZZER 8VA 230V~1M

- signal buzzer
 - the sound emission has the same lasting time as the control operation
 - supply voltage 230V~ 50Hz 8VA



ZVONO 8VA 12V~ 1M

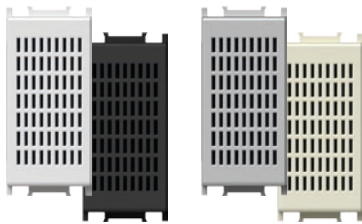

- EM91PW
- EM91SB
- EM91ES
- EM91IW

- signalno zvono
 - emisija zvuka traje vremenski jednako kao i postupak posluživanja
 - mrežni napon 230V~ 50Hz 8VA

BUZZER 8VA 12V~1M

- signal buzzer
 - the sound emission has the same lasting time as the control operation
 - supply voltage 12V~ 50Hz 8VA



ZVONO 8VA 230V~ 1M

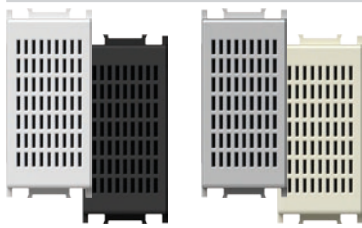

- EM92PW
- EM92SB
- EM92ES
- EM92IW

- signalno zvono
 - emisija zvuka traje vremenski jednako kao i postupak posluživanja
 - mrežni napon 230V~ 50Hz 8VA

BELL 8VA 230V~1M

- signal bell
 - the sound emission has the same lasting time as the control operation
 - supply voltage 230V~ 50Hz 8VA



ZVONO 8VA 12V~ 1M

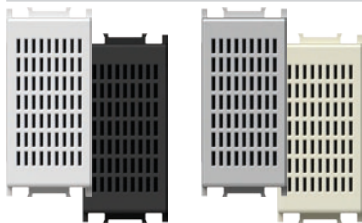

- EM93PW
- EM93SB
- EM93ES
- EM93IW

- signalno zvono
 - emisija zvuka traje vremenski jednako kao i postupak posluživanja
 - mrežni napon 230V~ 50Hz 8VA

BELL 8VA 12V~1M

- signal bell
 - the sound emission has the same lasting time as the control operation
 - supply voltage 12V~ 50Hz 8VA

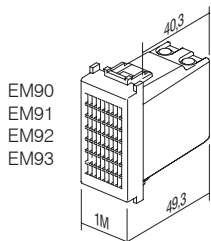

EM90
 EM91
 EM92
 EM93

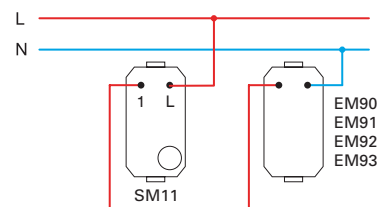



- EM95PW
- EM95SB
- EM95ES
- EM95IW

REGULATOR GLASNOĆE ZA 100V AUDIO LINIJU 35W 2M

- regulator glasnoće (atenuator) za 100V audio sustave
- nazivna snaga 35W (maks.45W), 6 razina glasnoće
- prikladan za ugradnju u kutije najmanje 60 mm dubine
- nije prikladan za ugradnju u kutije dubine 45 mm te podžbuknu ugradnju u kutije CUBO IP20
- samo za unutrašnju uporabu



VOLUME CONTROL 100V AUDIO LINE 35W 2M

- volume control (attenuator) for 100V audio systems
- power rating 35W (max.45W), 6 steps volume control
- suitable for boxes min. 60 mm deep
- not suitable for installation in 45 mm deep boxes and surface mount boxes CUBO IP20
- for indoor use only

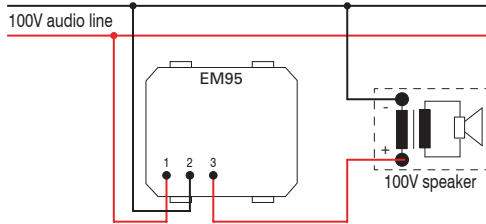

- EM96PW
- EM96SB
- EM96ES
- EM96IW

REGULATOR GLASNOĆE 4-8 Ω 35W 2M

- regulator glasnoće za niskonaponske izlaze 4-8 Ω, 35W
- nazivna snaga 35W, 6 razina glasnoće
- prikladan za ugradnju u kutije najmanje 60 mm dubine
- nije prikladan za ugradnju u kutije dubine 45 mm te podžbuknu ugradnju u kutije CUBO IP20
- samo za unutrašnju uporabu



VOLUME CONTROL 4-8 Ω 35W 2M

- volume control (attenuator) for low voltage outputs 4-8 Ω, 35W
- power rating 35W, 6 steps volume control
- suitable for boxes min. 60 mm deep
- not suitable for installation in 45 mm deep boxes and surface mount boxes CUBO IP20
- for indoor use only

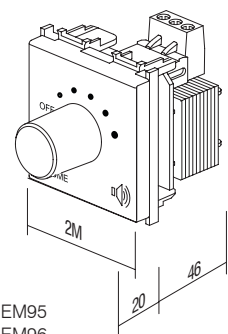
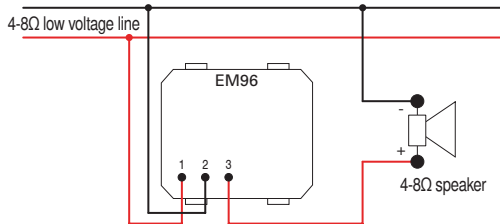



tip type	naziv description	tehnički podaci technical data	veličina size	boja colour	opcijski podaci 1 optional data 1
CM10	SET UTIČNICA 2X ŠUKO SOCKET SET 2x SCHUKO	2P+E 16A 250V~	4M	<input type="checkbox"/> PW bijela sjajna polar white	<input type="checkbox"/> OL okvir LINE cover plate LINE
CM11	SET UTIČNICA 3X ŠUKO SOCKET SET 3x SCHUKO	2P+E 16A 250V~	7M	<input checked="" type="checkbox"/> SB crna mat soft touch black	<input type="checkbox"/> OS okvir SOFT cover plate SOFT
CM15	SET SPOJNIH VODOVA LINK WIRE SET	3x1.5mm ²	1M	<input type="checkbox"/> ES srebrna mat elox silver	
...	<input type="checkbox"/> IW bež sjajna ivory white	

SET UTIČNICA 2x ŠUKO 2P+E 16A 250V~ 4M

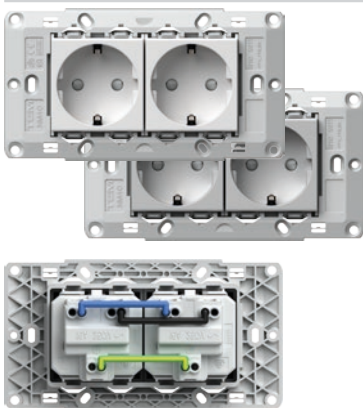

- CM10PW
- CM10ES

- set utičnica 2x šuko VM10 2P+E 16A 250V~
- utičnice povezane spojnim vodovima CM16
- s nosačem 4M bez vijaka
- za pričvršćivanje nosača vijci CM17, CM18 ili CM19
- vijčano pričvršćivanje vodiča presjeka 1,5-2,5 mm²
- sukladno normi IEC 60884-1, CEE7

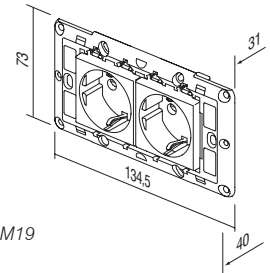

SOCKETS SET 2x SCHUKO 2P+E 16A 250V~ 4M

- socket set 2x schuko VM10 2P+E 16A 250V~
- prewired with link wires CM16
- with mounting frame 4M without screws
- for mounting frame fixing use screws CM17, CM18 or CM19
- screw contacts 1.5-2.5 mm²
- in accordance with IEC-60884-1, CEE7

SET UTIČNICA 3x ŠUKO 2P+E 16A 250V~ 7M

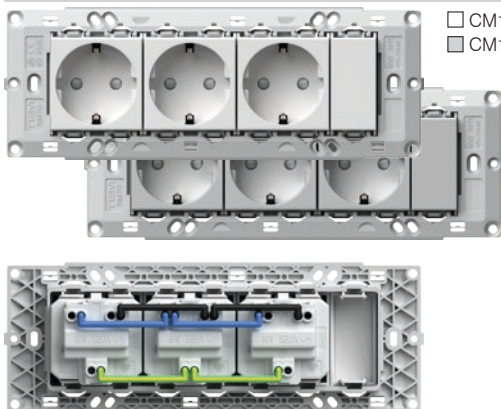

- CM11PW
- CM11ES

- set utičnica 3x šuko VM10 2P+E 16A 250V~
- utičnice povezane spojnim vodovima CM16
- s nosačem 7M bez vijaka
- za pričvršćivanje nosača vijci CM17, CM18 ili CM19
- vijčano pričvršćivanje vodiča presjeka 1,5-2,5 mm²
- sukladno normi IEC 60884-1, CEE7

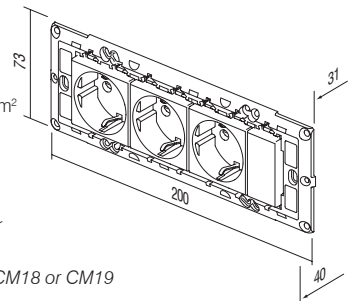

SOCKETS SET 3x SCHUKO 2P+E 16A 250V~ 7M

- socket set 3x schuko VM10 2P+E 16A 250V~
- prewired with link wires CM16
- with mounting frame 7M without screws
- for mounting frame fixing use screws CM17, CM18 or CM19
- screw contacts 1.5-2.5 mm²
- in accordance with IEC-60884-1, CEE7

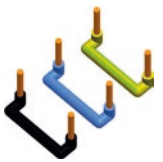

SET SPOJNIH VODOVA 3x1,5mm² 1M

CM15

- set spojnih vodova za povezivanje dvaju elemenata veličine 1M
- sadrži 10 crnih, 10 plavih i 10 žuto-zelenih spojnih vodova

LINK WIRE SET 3x1,5mm² 1M

- link wire set to connect two elements size 1M
- includes 10 black, 10 blue and 10 yellow/green wires

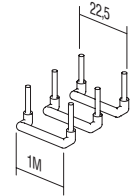



SET SPOJNIH VODOVA 3x2,5mm² 1M

CM16

- set spojnih vodova za povezivanje dvaju elemenata veličine 2M
- sadrži 10 crnih, 10 plavih i 10 žuto-zelenih spojnih vodova

LINK WIRE SET 3x2,5mm² 1M

- link wire set to connect two elements size 2M
- includes 10 black, 10 blue and 10 yellow/green wires





SET VIJAKA 3,5

CM17
CM18
CM19

- set vijaka za pričvršćivanje nosača NM30, NM32, NM40, NM41, NM70
- CM17 - l=20 mm, 100 kom.
- CM18 - l=35 mm, 50 kom.
- CM19 - l=50mm, 50 kom.

SCREW SET 3,5

- screw set for fixing mounting frames NM30, NM32, NM40, NM41, NM70
- CM17 - l=20mm, 100pcs
- CM18 - l=35mm, 50pcs
- CM19 - l=50mm, 50pcs

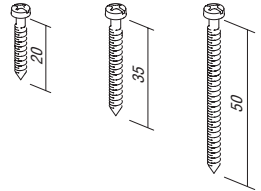



SET ZA SKLOPKE IP44 2M

CM22PW

- za ugradnju u vlažne prostore
- IP44 zaštita za sve Modul sklopke
- sklopke i tipke nisu sastavni dio seta
- okvir SOFT 2M s natpisnom pločicom
- sukladno normi IEC 60669-1

SET SWITCHES IP44 2M

- for usage in humid areas
- IP44 protection provides for all Modul switches
- switches and buttons are not part of the set
- SOFT 2M cover plate with inscription plate
- in accordance with IEC 60669-1





SET ZA UTIČNICU IP44 2M

CM23PW

- za ugradnju u vlažne prostore
- pruža IP44 zaštitu u kombinaciji s pokrivnom utičnicom (VM11, VM41)
- utičnice nisu sastavni dio seta
- okvir SOFT 2M s natpisnom pločicom
- sukladno normi IEC 60884-1

SET SOCKETS IP44 2M

- for usage in humid areas
- IP44 protection can be achieved only in combination with covered socket (VM11, VM41)
- sockets are not part of the set
- SOFT 2M cover plate with inscription plate
- in accordance with IEC 60884-1





KUPAONSKI SET 3x20AX 250V~ 4M

CM25PWOL
 CM25IWOL
 CM25PWOS
 CM25IWOS

- set sklopki 3xSM12 20AX 250V~ s nosačem i okvirom
- vijčano pričvršćivanje vodiča presjeka 1,5-2,5mm²
- sukladno normi EN 60669-1
- univerzalno rješenje za pričvršćivanje na već ugrađene kutije s razmakom pričvršćivanja od 108 do 135 mm ili na kutije veličine 4M
- visina okvira 90 mm

SWITCH SET FOR BATHROOM 3x20AX 250V~ 4M

- switch set 3xSM12 20AX 250V~ with mounting frame and cover plate
- screw contacts 1,5-2,5mm²
- in accordance with EN 60669-1
- universal solution for renovation on boxes with fixing dimensions 108-135mm or boxes 4M size
- cover plate height 90mm





NM41





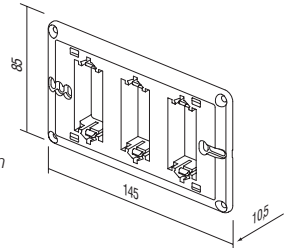

NOSAČI ZA KUPAONSKI SET 4M

- univerzalni nosač za kupaonski set s vijcima
- univerzalno rješenje za pričvršćivanje na pravokutne kutije s razmakom pričvršćivanja od 108 do 135 mm ili na kutije veličine 4M
- sukladno normi EN 60669-1

MOUNTING FRAME BATHROOM SET 4M

- universal mounting frame for bathroom set with screws
- universal solution for mounting on rectangular boxes with fixing dimensions 108-135mm or boxes 4M size
- in accordance with EN 60669-1



-  OL41PW
-  OL41NB
-  OL41IW
-  OL41ES
-  OL41SG
-  OL41IB
-  OL41MG





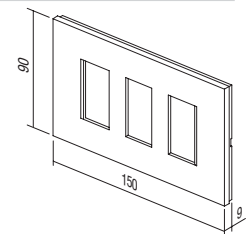

OKVIRI LINE ZA KUPAONSKI SET

- dekorativni okvir LINE za kupaonski set
- visina 90 mm
- sukladno normi EN 60669-1

COVER PLATE LINE BATHROOM SET

- decorative cover plate bathroom set LINE
- height 90mm
- in accordance with EN 60669-1



-  OS41PW
-  OS41NB
-  OS41IW
-  OS41ES
-  OS41SG
-  OS41SB
-  OS41WE

OKVIRI SOFT ZA KUPAONSKI SET



- dekorativni okvir SOFT za kupaonski set
- visina 90 mm
- sukladno normi EN 60669-1

COVER PLATE SOFT BATHROOM SET

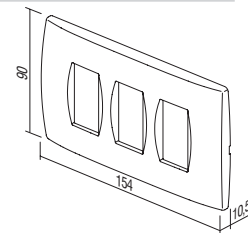
- decorative cover plate bathroom set SOFT
- height 90mm
- in accordance with EN 60669-1





tip type	naziv description	veličina size	boja colour	opsijski podaci 1 optional data 1
TM11	TIPKA BUTTON	1M	<input type="checkbox"/> AW antibakterijska bijela antibacterial white	 NT neutralna neutral
TM21	SLIJEPI ELEMENT BLANK	1M		
VM10	UTIČNICA SOCKET	2M		 IN indikator indicator
.	.	.		
.	.	.		

ANTIBAKTERIJSKI PROGRAM MODUL

- brojne osobe svakodnevno dotiču sklopke i utičnice koje su stoga mjesta razvoja i širenja bakterija
- zahvaljujući prirodnim antibakterijskim svojstvima, srebro se tri tisuće godina koristi kao sigurno dezinfekcijsko sredstvo, jer je potpuno prirodan i neškodljiv materijal te ne zagađuje okoliš
- posebni antibakterijski ioni srebra pružaju dugotrajnu, pouzdanu i učinkovitu zaštitu od razvoja i širenja bakterija, virusa, mikroba i gljivica
- antibakterijska zaštita osigurava kvalitetnu higijenu, čistoću i zdravlje ljudima
- savršeno prikladan za korištenje u okruženjima koja zahtijevaju stroge higijenske uvjete (bolnice, zdravstveni centri, farmaceutska postrojenja, domovi za starije i nemoćne, domovi umirovljenika, laboratoriji, restorani, hoteli, zračne luke, autobuse i željezničke postaje, poslovni i trgovački prostori, javne institucije...)
- neovisni laboratoriji obavili su testiranja sukladno najvišim japanskim standardima JIS Z 2801
- niski troškovi osiguravanja ljudskog zdravlja
- dizajn i funkcionalnost antibakterijskog programa MODUL omogućava jednostavno čišćenje i održavanje
- antibakterijske tipke, okviri i utičnice kombinirani su sa standardnim ugradbenim okvirima i sklopkama
- proizvodi su označeni sa stražnje strane kao AB (antibakterijska bijela)

ANTIBACTERIAL PROGRAM MODUL

- switches and sockets are daily touched by many people, so this is a common place for development and spread of bacteria
- thanks to its natural antibacterial characteristics silver has been used for three millennia as a safe and effective disinfectant, since it is completely natural, healthy and environmentally friendly
- special antibacterial silver ions additive provides long-term, reliable and effective protection against the development and spread of bacteria, viruses, microbes and fungi
- antibacterial protection ensures hygiene, cleanliness and health for people
- perfectly suitable for use in environments with strict hygiene conditions (hospitals, health centers, pharmaceutical facilities, homes for elderly, nursing homes, laboratories, restaurants, hotels, airports, bus and railway stations, business and shopping areas, public institutions ...)
- independent laboratory testings have been carried out in accordance with highest Japanese standards JIS Z 2801
- low cost for providing human health
- design and functionality of antibacterial program MODUL allow easy cleaning and maintenance
- antibacterial buttons, cover plates and sockets are combined with classic mounting frames and switches
- products are labelled on the back with AW (antibacterial white)

A N T I B A C T E R I A L P R O G R A M M O D U L

	□ TM11AW	TIPKA 1M - zamjenjiva tipka 1M - sukladno normi EN 60669-1 - antibakterijska zaštita usklađena s JIS Z 2801	
	□ TM11AWIN	TIPKA 1M INDIKATOR - zamjenjiva tipka 1M - sukladno normi EN 60669-1 - antibakterijska zaštita usklađena s JIS Z 2801	
	□ TM12AW	TIPKA 2M - zamjenjiva tipka 2M s nosačem tipke - upotrebljava se pri nadogradnji sklopke ili tipkala od veličine 1M na veličinu 2M - sukladno normi EN 60669-1 - antibakterijska zaštita usklađena s JIS Z 2801	
	□ TM12AWIN	TIPKA 2M INDIKATOR - zamjenjiva tipka 2M s nosačem tipke - upotrebljava se pri nadogradnji sklopke ili tipkala od veličine 1M na veličinu 2M - sukladno normi EN 60669-1 - antibakterijska zaštita usklađena s JIS Z 2801	
	□ TM21AW	SLIJEPI ELEMENT 1M - slijepi element za popunjavanje praznog mjesta - sukladno normi EN 60669-1 - antibakterijska zaštita usklađena s JIS Z 2801	
	□ TM22AW	SLIJEPI ELEMENT 2M - slijepi element za popunjavanje praznog mjesta - sukladno normi EN 60669-1 - antibakterijska zaštita usklađena s JIS Z 2801	

BUTTON 1M

- replaceable button 1M
- in accordance with EN 60669-1
- antibacterial protection in accordance with JIS Z 2801

BUTTON 1M INDICATOR

- replaceable button 1M
- in accordance with EN 60669-1
- antibacterial protection in accordance with JIS Z 2801

TIPKA 2M

- replaceable button 2M with button carrier
- to upgrade switch or push button from size 1M to size 2M
- in accordance with EN 60669-1
- antibacterial protection in accordance with JIS Z 2801

BUTTON 2M

- replaceable button 2M with button carrier
- to upgrade switch or push button from size 1M to size 2M
- in accordance with EN 60669-1
- antibacterial protection in accordance with JIS Z 2801

TIPKA 2M INDIKATOR

- replaceable button 2M with button carrier
- to upgrade switch or push button from size 1M to size 2M
- in accordance with EN 60669-1
- antibacterial protection in accordance with JIS Z 2801

BUTTON 2M INDICATOR

- blank modul to fill up empty spaces
- in accordance with EN 60669-1
- antibacterial protection in accordance with JIS Z 2801

BLANK 1M

- blank modul to fill up empty spaces
- in accordance with EN 60669-1
- antibacterial protection in accordance with JIS Z 2801

BLANK 2M

- blank modul to fill up empty spaces
- in accordance with EN 60669-1
- antibacterial protection in accordance with JIS Z 2801



□ VM10AW

UTIČNICA ŠUKO+KS 2P+E 16A 250V~ 2M

- 2P+E šuko
- 16A 250V~, tip VM10
- sukladno normama IEC 60884-1, CEE7
- vijčano pričvršćivanje vodiča presjeka 1,5-2,5 mm²
- KS zaštita za djecu od dodira kontakta
- antibakterijska zaštita usklađena s JIS Z 2801

SOCKET SCHUKO+KS 2P+E 16A 250V~ 2M

- 2P+E schuko
- 16A 250V~, type VM10
- in accordance with IEC 60884-1, CEE7
- screw contacts 1.5-2.5 mm²
- KS build-in child protection - shuttered live contacts
- antibacterial protection in accordance with JIS Z 2801



□□ VM11AW

UTIČNICA ŠUKO+KS +POKLOPAC 2P+E 16A 250V~ 2M

- 2P+E šuko+poklopac
- 16A 250V~, tip VM11
- sukladno normama IEC 60884-1, CEE7
- vijčano pričvršćivanje vodiča presjeka 1,5-2,5 mm²
- KS zaštita za djecu od dodira kontakta
- antibakterijska zaštita usklađena s JIS Z 2801

SOCKET SCHUKO+KS+COVER

- 2P+E schuko+cover
- 16A 250V~, type VM11
- in accordance with IEC 60884-1, CEE7
- screw contacts 1.5-2.5 mm²
- KS build-in child protection - shuttered live contacts
- antibacterial protection in accordance with JIS Z 2801



□ VM20AW

UTIČNICA EURO+KS 2P 10A 250V~ 1M

- 2P Euro
- 10A 250V~, tip VM20
- sukladno normama IEC 60884-1, CEE7
- vijčano pričvršćivanje vodiča presjeka 1,5-2,5 mm²
- KS zaštita za djecu od dodira kontakta
- antibakterijska zaštita usklađena s JIS Z 2801

SOCKET EURO+KS 2P 10A 250V~ 1M

- 2P Euro
- 10A 250V~, type VM20
- in accordance with IEC 60884-1, CEE7
- screw contacts 1.5-2.5 mm²
- KS build-in child protection - shuttered live contacts
- antibacterial protection in accordance with JIS Z 2801



□ KM11AW

UTIČNICA TV ZAVRŠNA 1dB 1M

- TV završna
- propušta frekvenciju u rasponu 5÷2400 MHz
- prigušenje < 1 dB
- sukladno normi EN 50083-1
- vijčano pričvršćivanje
- antibakterijska zaštita usklađena s JIS Z 2801

SOCKET TV END-LINE 1dB 1M

- TV end-line
- frequency range 5÷2400 MHz
- reduction < 1 dB
- in accordance with EN 50083-1
- screw contacts
- antibacterial protection in accordance with JIS Z 2801

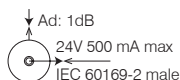

□ KM35AW

ADAPTER KS 1M

- KS keystone standard pričvršćivanja
- AMP, Avaya, Brandrex, FMT, Mfico, Tyco, ...
- nije ugraben komunikacijski modul
- antibakterijska zaštita usklađena s JIS Z 2801

ADAPTER KS 1M

- KS keystone fixing standard
- AMP, Avaya, Brandrex, FMT, Mfico, Tyco, ...
- communication module not included
- antibacterial protection in accordance with JIS Z 2801





OS20AW

OKVIR SOFT 2M

- dekorativni okvir SOFT 2M
- skladno normi EN 60669-1
- antibakterijska zaščita uskladenjena s JIS Z 2801

COVER PLATE SOFT 2M

- decorative cover plate SOFT 2M
- in accordance with EN 60669-1
- antibacterial protection in accordance with JIS Z 2801



OS24AW

OKVIR SOFT 2x2M

- dekorativni okvir SOFT 2x2M
- vodoravna ili okomita ugradnja
- skladno normi EN 60669-1
- antibakterijska zaščita uskladenjena s JIS Z 2801

COVER PLATE SOFT 2x2M

- decorative cover plate SOFT 2x2M
- horizontal or vertical mounting
- in accordance with EN 60669-1
- antibacterial protection in accordance with JIS Z 2801



OS26AW

OKVIR SOFT 3x2M

- dekorativni okvir SOFT 3x2M
- vodoravna ili okomita ugradnja
- skladno normi EN 60669-1
- antibakterijska zaščita uskladenjena s JIS Z 2801

COVER PLATE SOFT 3x2M

- decorative cover plate SOFT 3x2M
- horizontal or vertical mounting
- in accordance with EN 60669-1
- antibacterial protection in accordance with JIS Z 2801



OS30AW

OKVIR SOFT 3M

- dekorativni okvir SOFT 3M
- antibakterijska zaščita uskladenjena s JIS Z 2801
- skladno normi EN 60669-1

COVER PLATE SOFT 3M

- decorative cover plate SOFT 3M
- antibacterial protection in accordance with JIS Z 2801
- in accordance with EN 60669-1



OS40AW

OKVIR SOFT 4M

- dekorativni okvir SOFT 4M
- skladno normi EN 60669-1
- antibakterijska zaščita uskladenjena s JIS Z 2801

COVER PLATE SOFT 4M

- decorative cover plate SOFT 4M
- in accordance with EN 60669-1
- antibacterial protection in accordance with JIS Z 2801

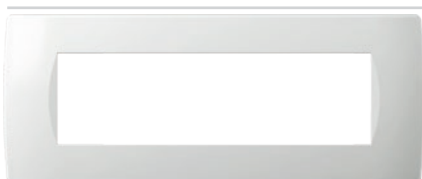

OS70AW

OKVIR SOFT 7M

- dekorativni okvir SOFT 7M
- skladno normi EN 60669-1
- antibakterijska zaščita uskladenjena s JIS Z 2801

COVER PLATE SOFT 7M

- decorative cover plate SOFT 7M
- in accordance with EN 60669-1
- antibacterial protection in accordance with JIS Z 2801

metal
metal

MH kovani čelik
hammered steel



ME lijevano željezo
etched iron



MS satenski srebrna
satin silver

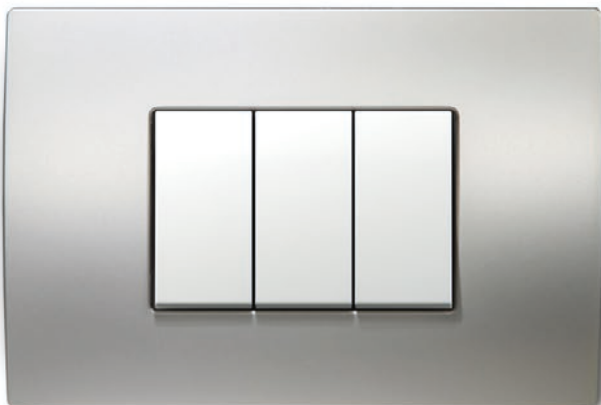

MN satenski poniklani
satin nickel



COVER PLATES PURE OP

drvo
wood

WB bambus
bamboo



WW orah
walnut



WM javor
maple



WE wenge
wenge



staklo
glass

GW ledeno bijela
ice white

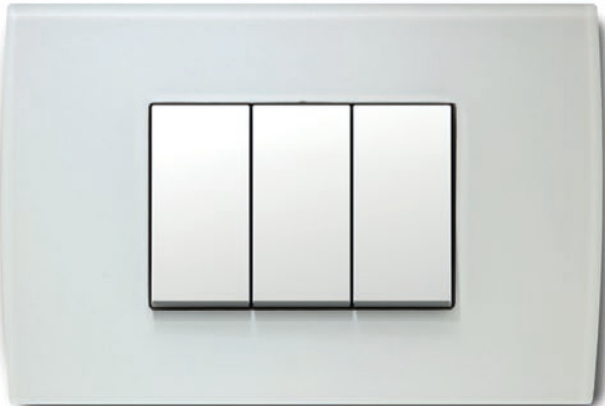

GG ledeno zelena
ice green

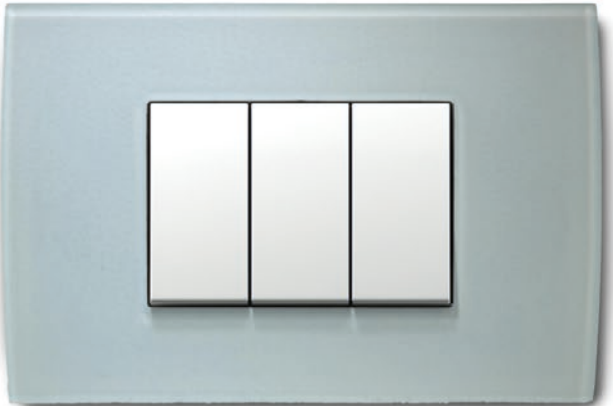

GY ledeno siva
ice grey

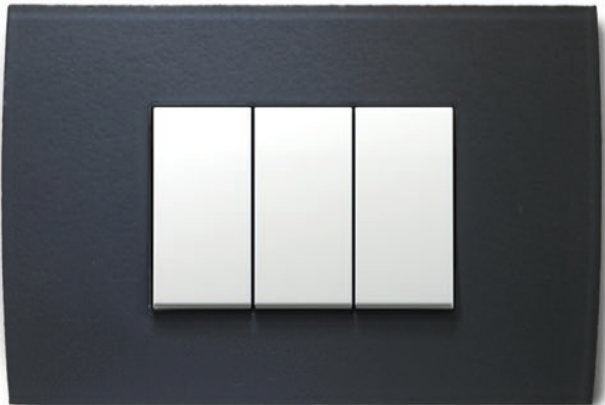

GB ledeno plava
ice blue

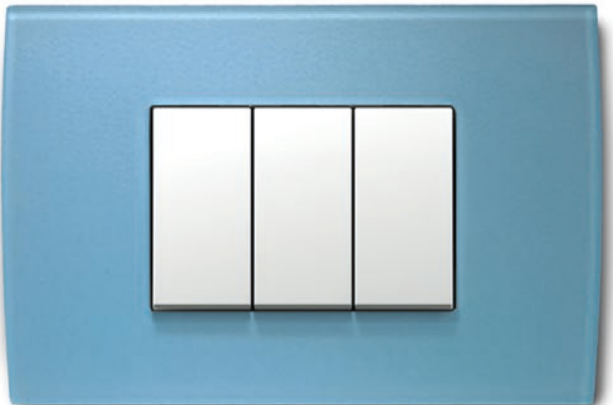



OP30

WB

tip type	naziv description	veličina size	boja colour	
OP13	OKVIR PURE COVER PLATE PURE	1/3M	MH kovani čelik hammered steel	WB bambus bamboo
OP20	OKVIR PURE COVER PLATE PURE	2M	ME lijevano željezo etched iron	WW orah walnut
OP23	OKVIR PURE COVER PLATE PURE	2/3M	MS satenski srebrna satin silver	WM javor maple
·	·	·	MN satenski poniklani satin nickel	WE wenge wenge
·	·	·		GW ledeno bijela ice white
·	·	·		GG ledeno zelena ice green
·	·	·		GY ledeno siva ice grey
·	·	·		GB ledeno plava ice blue



OP20MH	OP20WB
OP20ME	OP20WW
OP20MS	OP20WM
OP20MN	OP20WE
	OP20GW
	OP20GG
	OP20GY
	OP20GB

OKVIR PURE 2M

- dekorativni okvir PURE 2M
- sukladno normi EN 60669-1
- samo u kombinaciji s nosačem NM24 ili NM25

COVER PLATE PURE 2M

- decorative cover plate PURE 2M
- in accordance with EN 60669-1
- only in combination with mounting frame NM24 or NM25



OP24MH	OP24WB
OP24ME	OP24WW
OP24MS	OP24WM
OP24MN	OP24WE
	OP24GW
	OP24GG
	OP24GY
	OP24GB

OKVIR PURE 2x2M

- dekorativni okvir PURE 2x2M
- vodoravna ili okomita ugradnja
- sukladno normi EN 60669-1
- samo u kombinaciji s nosačem NM24 ili NM25

COVER PLATE PURE 2x2M

- decorative cover plate PURE 2x2M
- horizontal or vertical mounting
- in accordance with EN 60669-1
- only in combination with mounting frames NM24 or NM25



OP26MH	OP26WB
OP26ME	OP26WW
OP26MS	OP26WM
OP26MN	OP26WE
	OP26GW
	OP26GG
	OP26GY
	OP26GB

OKVIR PURE 3x2M

- dekorativni okvir PURE 3x2M
- vodoravna ili okomita ugradnja
- sukladno normi EN 60669-1
- samo u kombinaciji s nosačem NM24 ili NM25

COVER PLATE PURE 3x2M

- decorative cover plate PURE 3x2M
- horizontal or vertical mounting
- in accordance with EN 60669-1
- only in combination with mounting frames NM24 or NM25

COVER PLATES PURE OP



	OP30MH		OP30WB
	OP30ME		OP30WW
	OP30MS		OP30WM
	OP30MN		OP30WE
			OP30GW
			OP30GG
			OP30GY
			OP30GB

OKVIR PURE 3M

- dekorativni okvir PURE 3M
- skladno normi EN 60669-1

COVER PLATE PURE 3M

- decorative cover plate PURE 3M
- in accordance with EN 60669-1



	OP40MH		OP40WB
	OP40ME		OP40WW
	OP40MS		OP40WM
	OP40MN		OP40WE
			OP40GW
			OP40GG
			OP40GY
			OP40GB

OKVIR PURE 4M

- dekorativni okvir PURE 4M
- skladno normi EN 60669-1

COVER PLATE PURE 4M

- decorative cover plate PURE 4M
- in accordance with EN 60669-1



	OP70MH		OP70WB
	OP70ME		OP70WW
	OP70MS		OP70WM
	OP70MN		OP70WE
			OP70GW
			OP70GG
			OP70GY
			OP70GB

OKVIR PURE 7M

- dekorativni okvir PURE 7M
- skladno normi EN 60669-1

COVER PLATE PURE 7M

- decorative cover plate PURE 7M
- in accordance with EN 60669-1

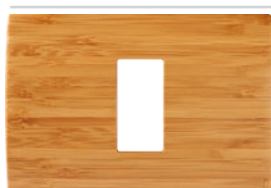

	OP13MH		OP13WB
	OP13ME		OP13WW
	OP13MS		OP13WM
	OP13MN		OP13WE
			OP13GW
			OP13GG
			OP13GY
			OP13GB

OKVIR PURE 1/3M

- dekorativni okvir PURE 1/3M
- skladno normi EN 60669-1

COVER PLATE PURE 1/3M

- decorative cover plate PURE 1/3M
- in accordance with EN 60669-1



	OP23MH		OP23WB
	OP23ME		OP23WW
	OP23MS		OP23WM
	OP23MN		OP23WE
			OP23GW
			OP23GG
			OP23GY
			OP23GB

OKVIR PURE 2/3M

- dekorativni okvir PURE 2/3M
- skladno normi EN 60669-1

COVER PLATE PURE 2/3M

- decorative cover plate PURE 2/3M
- in accordance with EN 60669-1

osnovni
basic

PW bijela sjajna
polar white

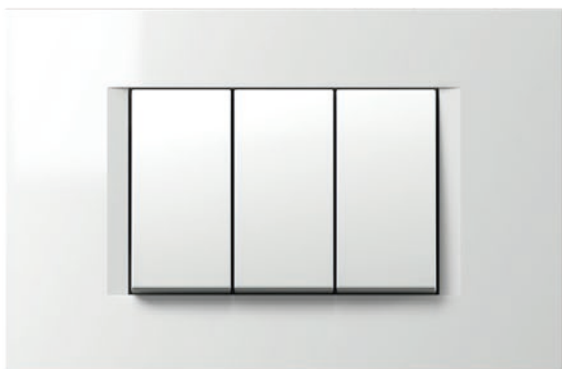

IW bež sjajna
ivory white

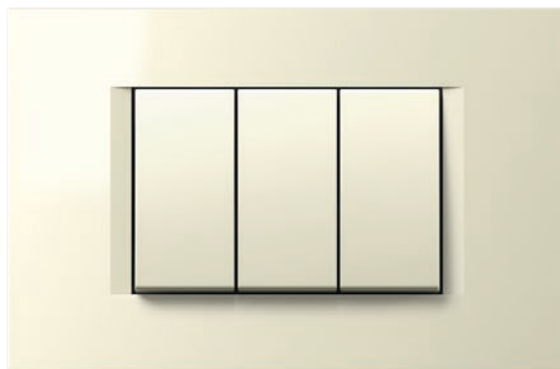

ES srebrna mat
elox silver



SB crna mat
soft touch black

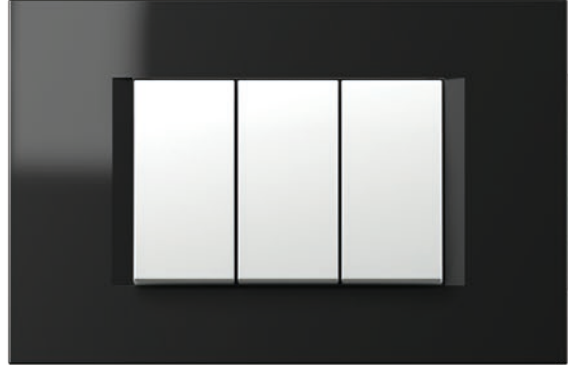
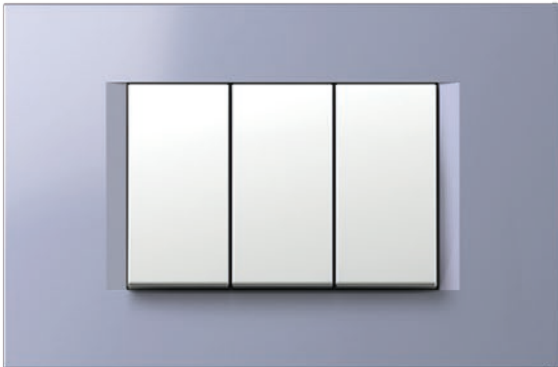
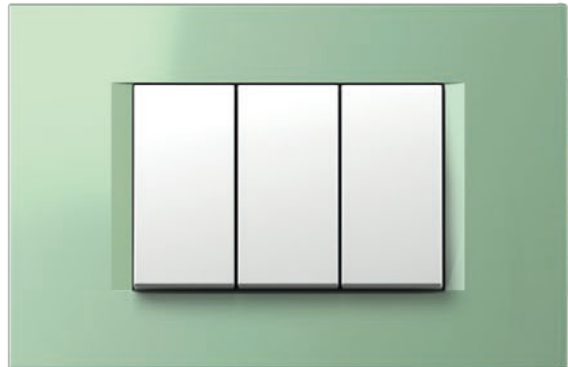

COVER PLATES LINE OL

dekor
decorSG zlatna mat
sand goldNG crna sjajna
night blackIB plava mat
impulse blueMG zelena mat
mint greenSE kamen smaragd
stone emeraldSW kamen bijeli
stone white

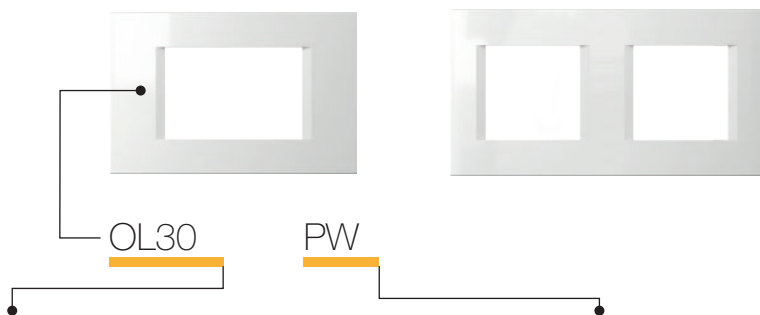

tip type	naziv description	veličina size	boja colour																																																
OL10	OKVIR LINE COVER PLATE LINE	1/2M	<table border="0"> <tr> <td></td> <td>PW</td> <td>bijela sjajna polar white</td> <td> <table border="0"> <tr> <td></td> <td>SG</td> <td>zlatna mat sand gold</td> <td> <table border="0"> <tr> <td></td> <td>SE</td> <td>kamen smaragd stone emerald</td> </tr> </table> </td> </tr> </table> </td> </tr> <tr> <td>OL13</td> <td>OKVIR LINE COVER PLATE LINE</td> <td>1/3M</td> <td> <table border="0"> <tr> <td></td> <td>IW</td> <td>bež sjajna ivory white</td> <td> <table border="0"> <tr> <td></td> <td>NB</td> <td>crna sjajna night black</td> <td> <table border="0"> <tr> <td></td> <td>SW</td> <td>kamen bijeli stone white</td> </tr> </table> </td> </tr> </table> </td> </tr> <tr> <td>OL20</td> <td>OKVIR LINE COVER PLATE LINE</td> <td>2M</td> <td> <table border="0"> <tr> <td></td> <td>ES</td> <td>srebrna mat elox silver</td> <td> <table border="0"> <tr> <td></td> <td>IB</td> <td>plava mat impulse blue</td> </tr> </table> </td> </tr> <tr> <td></td> <td></td> <td></td> <td> <table border="0"> <tr> <td></td> <td>SB</td> <td>crna mat soft touch black</td> <td> <table border="0"> <tr> <td></td> <td>MG</td> <td>zelenla mat mint green</td> </tr> </table> </td> </tr> </table> </td> </tr> </table></td></tr></table></td></tr></table>		PW	bijela sjajna polar white	<table border="0"> <tr> <td></td> <td>SG</td> <td>zlatna mat sand gold</td> <td> <table border="0"> <tr> <td></td> <td>SE</td> <td>kamen smaragd stone emerald</td> </tr> </table> </td> </tr> </table>		SG	zlatna mat sand gold	<table border="0"> <tr> <td></td> <td>SE</td> <td>kamen smaragd stone emerald</td> </tr> </table>		SE	kamen smaragd stone emerald	OL13	OKVIR LINE COVER PLATE LINE	1/3M	<table border="0"> <tr> <td></td> <td>IW</td> <td>bež sjajna ivory white</td> <td> <table border="0"> <tr> <td></td> <td>NB</td> <td>crna sjajna night black</td> <td> <table border="0"> <tr> <td></td> <td>SW</td> <td>kamen bijeli stone white</td> </tr> </table> </td> </tr> </table> </td> </tr> <tr> <td>OL20</td> <td>OKVIR LINE COVER PLATE LINE</td> <td>2M</td> <td> <table border="0"> <tr> <td></td> <td>ES</td> <td>srebrna mat elox silver</td> <td> <table border="0"> <tr> <td></td> <td>IB</td> <td>plava mat impulse blue</td> </tr> </table> </td> </tr> <tr> <td></td> <td></td> <td></td> <td> <table border="0"> <tr> <td></td> <td>SB</td> <td>crna mat soft touch black</td> <td> <table border="0"> <tr> <td></td> <td>MG</td> <td>zelenla mat mint green</td> </tr> </table> </td> </tr> </table> </td> </tr> </table></td></tr></table>		IW	bež sjajna ivory white	<table border="0"> <tr> <td></td> <td>NB</td> <td>crna sjajna night black</td> <td> <table border="0"> <tr> <td></td> <td>SW</td> <td>kamen bijeli stone white</td> </tr> </table> </td> </tr> </table>		NB	crna sjajna night black	<table border="0"> <tr> <td></td> <td>SW</td> <td>kamen bijeli stone white</td> </tr> </table>		SW	kamen bijeli stone white	OL20	OKVIR LINE COVER PLATE LINE	2M	<table border="0"> <tr> <td></td> <td>ES</td> <td>srebrna mat elox silver</td> <td> <table border="0"> <tr> <td></td> <td>IB</td> <td>plava mat impulse blue</td> </tr> </table> </td> </tr> <tr> <td></td> <td></td> <td></td> <td> <table border="0"> <tr> <td></td> <td>SB</td> <td>crna mat soft touch black</td> <td> <table border="0"> <tr> <td></td> <td>MG</td> <td>zelenla mat mint green</td> </tr> </table> </td> </tr> </table> </td> </tr> </table>		ES	srebrna mat elox silver	<table border="0"> <tr> <td></td> <td>IB</td> <td>plava mat impulse blue</td> </tr> </table>		IB	plava mat impulse blue				<table border="0"> <tr> <td></td> <td>SB</td> <td>crna mat soft touch black</td> <td> <table border="0"> <tr> <td></td> <td>MG</td> <td>zelenla mat mint green</td> </tr> </table> </td> </tr> </table>		SB	crna mat soft touch black	<table border="0"> <tr> <td></td> <td>MG</td> <td>zelenla mat mint green</td> </tr> </table>		MG	zelenla mat mint green
	PW	bijela sjajna polar white	<table border="0"> <tr> <td></td> <td>SG</td> <td>zlatna mat sand gold</td> <td> <table border="0"> <tr> <td></td> <td>SE</td> <td>kamen smaragd stone emerald</td> </tr> </table> </td> </tr> </table>		SG	zlatna mat sand gold	<table border="0"> <tr> <td></td> <td>SE</td> <td>kamen smaragd stone emerald</td> </tr> </table>		SE	kamen smaragd stone emerald																																									
	SG	zlatna mat sand gold	<table border="0"> <tr> <td></td> <td>SE</td> <td>kamen smaragd stone emerald</td> </tr> </table>		SE	kamen smaragd stone emerald																																													
	SE	kamen smaragd stone emerald																																																	
OL13	OKVIR LINE COVER PLATE LINE	1/3M	<table border="0"> <tr> <td></td> <td>IW</td> <td>bež sjajna ivory white</td> <td> <table border="0"> <tr> <td></td> <td>NB</td> <td>crna sjajna night black</td> <td> <table border="0"> <tr> <td></td> <td>SW</td> <td>kamen bijeli stone white</td> </tr> </table> </td> </tr> </table> </td> </tr> <tr> <td>OL20</td> <td>OKVIR LINE COVER PLATE LINE</td> <td>2M</td> <td> <table border="0"> <tr> <td></td> <td>ES</td> <td>srebrna mat elox silver</td> <td> <table border="0"> <tr> <td></td> <td>IB</td> <td>plava mat impulse blue</td> </tr> </table> </td> </tr> <tr> <td></td> <td></td> <td></td> <td> <table border="0"> <tr> <td></td> <td>SB</td> <td>crna mat soft touch black</td> <td> <table border="0"> <tr> <td></td> <td>MG</td> <td>zelenla mat mint green</td> </tr> </table> </td> </tr> </table> </td> </tr> </table></td></tr></table>		IW	bež sjajna ivory white	<table border="0"> <tr> <td></td> <td>NB</td> <td>crna sjajna night black</td> <td> <table border="0"> <tr> <td></td> <td>SW</td> <td>kamen bijeli stone white</td> </tr> </table> </td> </tr> </table>		NB	crna sjajna night black	<table border="0"> <tr> <td></td> <td>SW</td> <td>kamen bijeli stone white</td> </tr> </table>		SW	kamen bijeli stone white	OL20	OKVIR LINE COVER PLATE LINE	2M	<table border="0"> <tr> <td></td> <td>ES</td> <td>srebrna mat elox silver</td> <td> <table border="0"> <tr> <td></td> <td>IB</td> <td>plava mat impulse blue</td> </tr> </table> </td> </tr> <tr> <td></td> <td></td> <td></td> <td> <table border="0"> <tr> <td></td> <td>SB</td> <td>crna mat soft touch black</td> <td> <table border="0"> <tr> <td></td> <td>MG</td> <td>zelenla mat mint green</td> </tr> </table> </td> </tr> </table> </td> </tr> </table>		ES	srebrna mat elox silver	<table border="0"> <tr> <td></td> <td>IB</td> <td>plava mat impulse blue</td> </tr> </table>		IB	plava mat impulse blue				<table border="0"> <tr> <td></td> <td>SB</td> <td>crna mat soft touch black</td> <td> <table border="0"> <tr> <td></td> <td>MG</td> <td>zelenla mat mint green</td> </tr> </table> </td> </tr> </table>		SB	crna mat soft touch black	<table border="0"> <tr> <td></td> <td>MG</td> <td>zelenla mat mint green</td> </tr> </table>		MG	zelenla mat mint green															
	IW	bež sjajna ivory white	<table border="0"> <tr> <td></td> <td>NB</td> <td>crna sjajna night black</td> <td> <table border="0"> <tr> <td></td> <td>SW</td> <td>kamen bijeli stone white</td> </tr> </table> </td> </tr> </table>		NB	crna sjajna night black	<table border="0"> <tr> <td></td> <td>SW</td> <td>kamen bijeli stone white</td> </tr> </table>		SW	kamen bijeli stone white																																									
	NB	crna sjajna night black	<table border="0"> <tr> <td></td> <td>SW</td> <td>kamen bijeli stone white</td> </tr> </table>		SW	kamen bijeli stone white																																													
	SW	kamen bijeli stone white																																																	
OL20	OKVIR LINE COVER PLATE LINE	2M	<table border="0"> <tr> <td></td> <td>ES</td> <td>srebrna mat elox silver</td> <td> <table border="0"> <tr> <td></td> <td>IB</td> <td>plava mat impulse blue</td> </tr> </table> </td> </tr> <tr> <td></td> <td></td> <td></td> <td> <table border="0"> <tr> <td></td> <td>SB</td> <td>crna mat soft touch black</td> <td> <table border="0"> <tr> <td></td> <td>MG</td> <td>zelenla mat mint green</td> </tr> </table> </td> </tr> </table> </td> </tr> </table>		ES	srebrna mat elox silver	<table border="0"> <tr> <td></td> <td>IB</td> <td>plava mat impulse blue</td> </tr> </table>		IB	plava mat impulse blue				<table border="0"> <tr> <td></td> <td>SB</td> <td>crna mat soft touch black</td> <td> <table border="0"> <tr> <td></td> <td>MG</td> <td>zelenla mat mint green</td> </tr> </table> </td> </tr> </table>		SB	crna mat soft touch black	<table border="0"> <tr> <td></td> <td>MG</td> <td>zelenla mat mint green</td> </tr> </table>		MG	zelenla mat mint green																														
	ES	srebrna mat elox silver	<table border="0"> <tr> <td></td> <td>IB</td> <td>plava mat impulse blue</td> </tr> </table>		IB	plava mat impulse blue																																													
	IB	plava mat impulse blue																																																	
			<table border="0"> <tr> <td></td> <td>SB</td> <td>crna mat soft touch black</td> <td> <table border="0"> <tr> <td></td> <td>MG</td> <td>zelenla mat mint green</td> </tr> </table> </td> </tr> </table>		SB	crna mat soft touch black	<table border="0"> <tr> <td></td> <td>MG</td> <td>zelenla mat mint green</td> </tr> </table>		MG	zelenla mat mint green																																									
	SB	crna mat soft touch black	<table border="0"> <tr> <td></td> <td>MG</td> <td>zelenla mat mint green</td> </tr> </table>		MG	zelenla mat mint green																																													
	MG	zelenla mat mint green																																																	



	OL20PW		OL20SG
	OL20IW		OL20NB
	OL20ES		OL20IB
	OL20SB		OL20MG
			OL20SE
			OL20SW

OKVIR LINE 2M

- dekorativni okvir LINE 2M
- sukladno normi EN 60669-1

COVER PLATE LINE 2M

- decorative cover plate LINE 2M
- in accordance with EN 60669-1



	OL24PW		OL24SG
	OL24IW		OL24NB
	OL24ES		OL24IB
	OL24SB		OL24MG
			OL24SE
			OL24SW

OKVIR LINE 2x2M

- dekorativni okvir LINE 2x2M
- vodoravna ili okomita ugradnja
- sukladno normi EN 60669-1

COVER PLATE LINE 2x2M

- decorative cover plate LINE 2x2M
- horizontal or vertical mounting
- in accordance with EN 60669-1

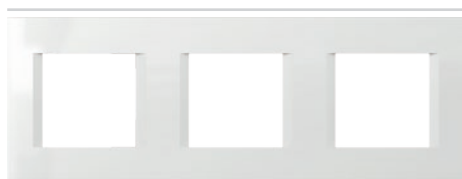

	OL26PW		OL26SG
	OL26IW		OL26NB
	OL26ES		OL26IB
	OL26SB		OL26MG
			OL26SE
			OL26SW

OKVIR LINE 3x2M

- dekorativni okvir LINE 3x2M
- vodoravna ili okomita ugradnja
- sukladno normi EN 60669-1

COVER PLATE LINE 3x2M

- decorative cover plate LINE 3x2M
- horizontal or vertical mounting
- in accordance with EN 60669-1



	OL28PW		OL28SG
	OL28IW		OL28NB
	OL28ES		OL28IB
	OL28SB		OL28MG
			OL28SE
			OL28SW

OKVIR LINE 4x2M

- dekorativni okvir LINE 4x2M
- vodoravna ili okomita ugradnja
- sukladno normi EN 60669-1

COVER PLATE LINE 4x2M

- decorative cover plate LINE 4x2M
- horizontal or vertical mounting
- in accordance with EN 60669-1

COVER PLATES LINE OL



	OL30PW		OL30SG
	OL30IW		OL30NB
	OL30ES		OL30IB
	OL30SB		OL30MG
			OL30SE
			OL30SW

OKVIR LINE 3M

- dekorativni okvir LINE 3M
- skladno normi EN 60669-1

COVER PLATE LINE 3M

- decorative cover plate LINE 3M
- in accordance with EN 60669-1



	OL40PW		OL40SG
	OL40IW		OL40NB
	OL40ES		OL40IB
	OL40SB		OL40MG
			OL40SE
			OL40SW

OKVIR LINE 4M

- dekorativni okvir LINE 4M
- skladno normi EN 60669-1

COVER PLATE LINE 4M

- decorative cover plate LINE 4M
- in accordance with EN 60669-1

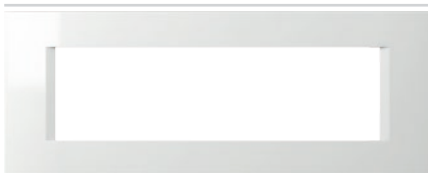

	OL70PW		OL70SG
	OL70IW		OL70NB
	OL70ES		OL70IB
	OL70SB		OL70MG
			OL70SE
			OL70SW

OKVIR LINE 7M

- dekorativni okvir LINE 7M
- skladno normi EN 60669-1

COVER PLATE LINE 7M

- decorative cover plate LINE 7M
- in accordance with EN 60669-1



	OL10PW		OL10SG
	OL10IW		OL10NB
	OL10ES		OL10IB
	OL10SB		OL10MG
			OL10SE
			OL10SW

OKVIR LINE 1/2M

- dekorativni okvir LINE 1/2M
- skladno normi EN 60669-1

COVER PLATE LINE 1/2M

- decorative cover plate LINE 1/2M
- in accordance with EN 60669-1



	OL13PW		OL13SG
	OL13IW		OL13NB
	OL13ES		OL13IB
	OL13SB		OL13MG
			OL13SE
			OL13SW

OKVIR LINE 1/3M

- dekorativni okvir LINE 1/3M
- skladno normi EN 60669-1

COVER PLATE LINE 1/3M

- decorative cover plate LINE 1/3M
- in accordance with EN 60669-1



	OL23PW		OL23SG
	OL23IW		OL23NB
	OL23ES		OL23IB
	OL23SB		OL23MG
			OL23SE
			OL23SW

OKVIR LINE 2/3M

- dekorativni okvir LINE 2/3M
- skladno normi EN 60669-1

COVER PLATE LINE 2/3M

- decorative cover plate LINE 2/3M
- in accordance with EN 60669-1

osnovni
basic

PW bijela sjajna
polar white

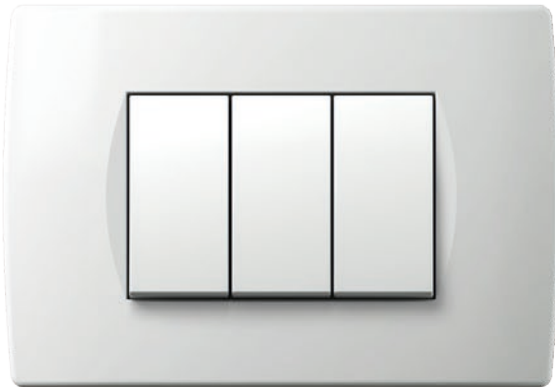

IW bež sjajna
ivory white

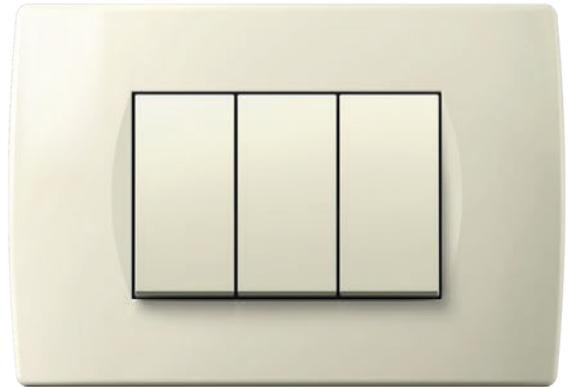

ES srebrna mat
elox silver

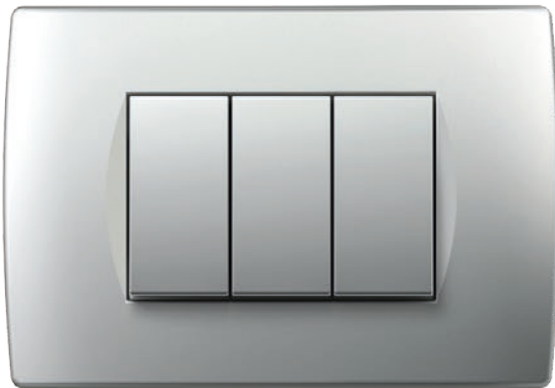

SB crna mat
soft touch black

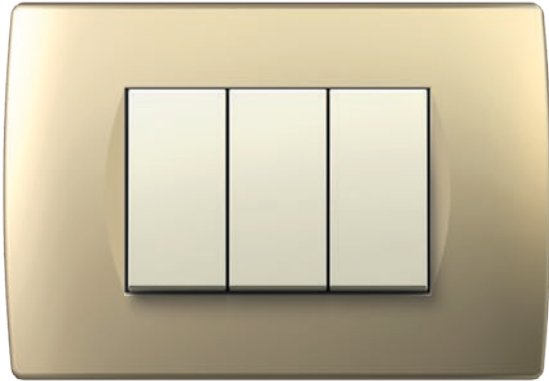

COVER PLATES SOFT OS

dekor
decorSG zlatna mat
sand goldNG crna sjajna
night blackWP smreka
spruceWW orah
walnutWE wenge
wenge



OS30

PW

tip type	naziv description	veličina size	boja colour												
OS10	OKVIR SOFT COVER PLATE SOFT	1/2M	<table border="0"> <tr> <td></td> <td>PW</td> <td>bijela sjajna polar white</td> <td></td> <td>SG</td> <td>zlatna mat sand gold</td> <td></td> <td>WP</td> <td>smreka spruce</td> </tr> </table>		PW	bijela sjajna polar white		SG	zlatna mat sand gold		WP	smreka spruce			
	PW	bijela sjajna polar white		SG	zlatna mat sand gold		WP	smreka spruce							
OS13	OKVIR SOFT COVER PLATE SOFT	1/3M	<table border="0"> <tr> <td></td> <td>IW</td> <td>bež sjajna ivory white</td> <td></td> <td>NB</td> <td>crna sjajna night black</td> <td></td> <td>WW</td> <td>orah walnut</td> </tr> </table>		IW	bež sjajna ivory white		NB	crna sjajna night black		WW	orah walnut			
	IW	bež sjajna ivory white		NB	crna sjajna night black		WW	orah walnut							
OS20	OKVIR SOFT COVER PLATE SOFT	2M	<table border="0"> <tr> <td></td> <td>ES</td> <td>srebrna mat elox silver</td> <td></td> <td>WE</td> <td>wenge wenge</td> </tr> <tr> <td></td> <td>SB</td> <td>crna mat soft touch black</td> <td></td> <td></td> <td></td> </tr> </table>		ES	srebrna mat elox silver		WE	wenge wenge		SB	crna mat soft touch black			
	ES	srebrna mat elox silver		WE	wenge wenge										
	SB	crna mat soft touch black													



	OS20PW		OS20SG
	OS20IW		OS20NB
	OS20ES		OS20WW
	OS20SB		OS20WE

OKVIR SOFT 2M

- dekorativni okvir SOFT 2M
- sukladno normi EN 60669-1

COVER PLATE SOFT 2M

- decorative cover plate SOFT 2M
- in accordance with EN 60669-1



	OS24PW		OS24SG
	OS24IW		OS24NB
	OS24ES		OS24WW
	OS24SB		OS24WE

OKVIR SOFT 2x2M

- dekorativni okvir SOFT 2x2M
- vodoravna ili okomita ugradnja
- sukladno normi EN 60669-1

COVER PLATE SOFT 2x2M

- decorative cover plate SOFT 2x2M
- horizontal or vertical mounting
- in accordance with EN 60669-1



	OS26PW		OS26SG
	OS26IW		OS26NB
	OS26ES		OS26WW
	OS26SB		OS26WE

OKVIR SOFT 3x2M

- dekorativni okvir SOFT 3x2M
- vodoravna ili okomita ugradnja
- sukladno normi EN 60669-1

COVER PLATE SOFT 3x2M

- decorative cover plate SOFT 3x2M
- horizontal or vertical mounting
- in accordance with EN 60669-1



	OS28PW		OS28SG
	OS28IW		OS28NB
	OS28ES		OS28WW
	OS28SB		OS28WE

OKVIR SOFT 4x2M

- dekorativni okvir SOFT 4x2M
- vodoravna ili okomita ugradnja
- sukladno normi EN 60669-1

COVER PLATE SOFT 4x2M

- decorative cover plate SOFT 4x2M
- horizontal or vertical mounting
- in accordance with EN 60669-1

COVER PLATES SOFT OS



	OS30PW		OS30SG
	OS30IW		OS30NB
	OS30ES		OS30WP
	OS30SB		OS30WW
			OS30WE

OKVIR SOFT 3M

- dekorativni okvir SOFT 3M
- sukladno normi EN 60669-1

COVER PLATE SOFT 3M

- decorative cover plate SOFT 3M
- in accordance with EN 60669-1



	OS40PW		OS40SG
	OS40IW		OS40NB
	OS40ES		OS40WP
	OS40SB		OS40WW
			OS40WE

OKVIR SOFT 4M

- dekorativni okvir SOFT 4M
- sukladno normi EN 60669-1

COVER PLATE SOFT 4M

- decorative cover plate SOFT 4M
- in accordance with EN 60669-1

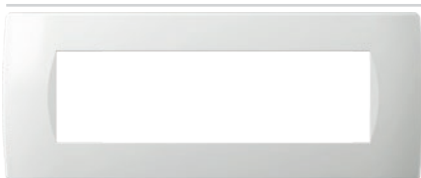

	OS70PW		OS70SG
	OS70IW		OS70NB
	OS70ES		OS70WP
	OS70SB		OS70WW
			OS70WE





OKVIR SOFT 7M

- dekorativni okvir SOFT 7M
- sukladno normi EN 60669-1

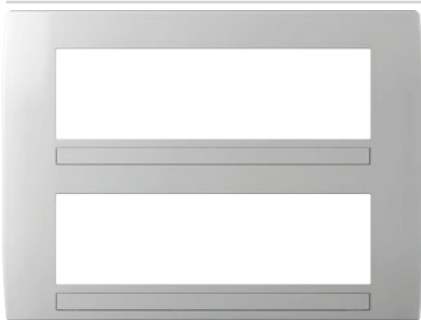
COVER PLATE SOFT 7M

- decorative cover plate SOFT 7M
- in accordance with EN 60669-1



	OS72PW
	OS72IW
	OS72ES
	OS72SB

OKVIR SOFT 2x7M

- dekorativni okvir SOFT 2x7M s
natpisnom pločicom
- sukladno normi EN 60669-1

COVER PLATE SOFT 2x7M

- decorative cover plate SOFT 2x7M
with inscription plate
- in accordance with EN 60669-1



	OS10PW		OS10SG
	OS10IW		OS10NB
	OS10ES		OS10WP
	OS10SB		OS10WW
			OS10WE





OKVIR SOFT 1/2M

- dekorativni okvir SOFT 1/2M
- sukladno normi EN 60669-1

COVER PLATE SOFT 1/2M

- decorative cover plate SOFT 1/2M
- in accordance with EN 60669-1



	OS13PW		OS13SG
	OS13IW		OS13NB
	OS13ES		OS13WP
	OS13SB		OS13WW
			OS13WE









OKVIR SOFT 1/3M

- dekorativni okvir SOFT 1/3M
- sukladno normi EN 60669-1

COVER PLATE SOFT 1/3M

- decorative cover plate SOFT 1/3M
- in accordance with EN 60669-1



	OS23PW		OS23SG
	OS23IW		OS23NB
	OS23ES		OS23WP
	OS23SB		OS23WW
			OS23WE

OKVIR SOFT 2/3M

- dekorativni okvir SOFT 2/3M
- sukladno normi EN 60669-1

COVER PLATE SOFT 2/3M

- decorative cover plate SOFT 2/3M
- in accordance with EN 60669-1



LASERSKO GRAVIRANJE NA OKVIRIMA

- lasersko graviranje proizvoljne grafike
- izrada po narudžbi
- prikladno za okvire OL, OS

LASER PRINT ON COVER PLATES

- laser print of any graphics
- made on request
- suitable for cover plates OL, OS



UKRAŠAVANJE OKVIRA







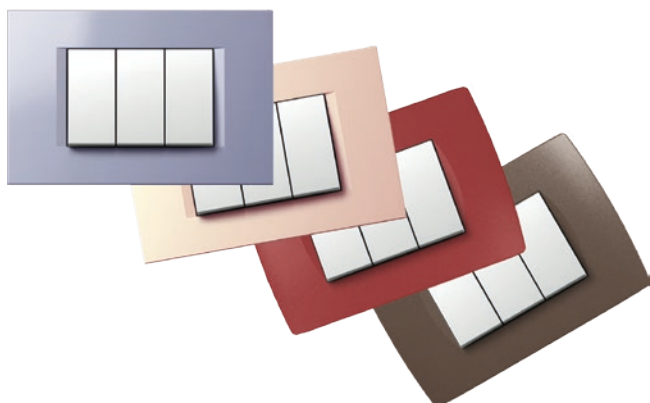

- tekstura i boje po želji kupca
- izrada po narudžbi
- prikladno za okvire OL, OS

COVER PLATES DECORATIONS

- customised textures and colours
- made on request
- suitable for cover plates OL, OS

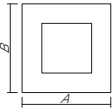
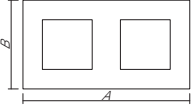
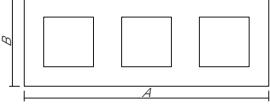
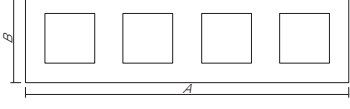

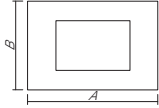
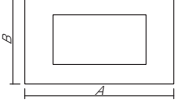
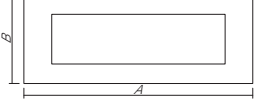
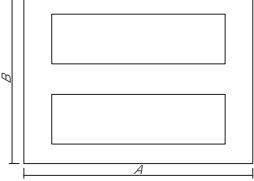
FRAMES

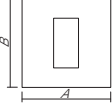
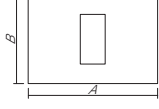
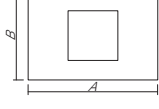
		 line A x B	 soft A x B	 PURE A x B
				
2M		80 x 80 mm	84 x 84 mm	93 x 90 mm
2x2M		151 x 80 mm	155 x 84 mm	164 x 90 mm
3x2M		222 x 80 mm	226 x 84 mm	235 x 90 mm
4x2M		293 x 80 mm	297 x 84 mm	
				
3M		122 x 80 mm	122 x 84 mm	134 x 90 mm
4M		149 x 80 mm	144 x 84 mm	157 x 90 mm
7M		207 x 80 mm	212 x 84 mm	224 x 90 mm
2x7M			212 x 158 mm	
				
1/2M		80 x 80 mm	84 x 84 mm	
1/3M		122 x 80 mm	122 x 84 mm	134 x 90 mm
2/3M		122 x 80 mm	122 x 84 mm	134 x 90 mm

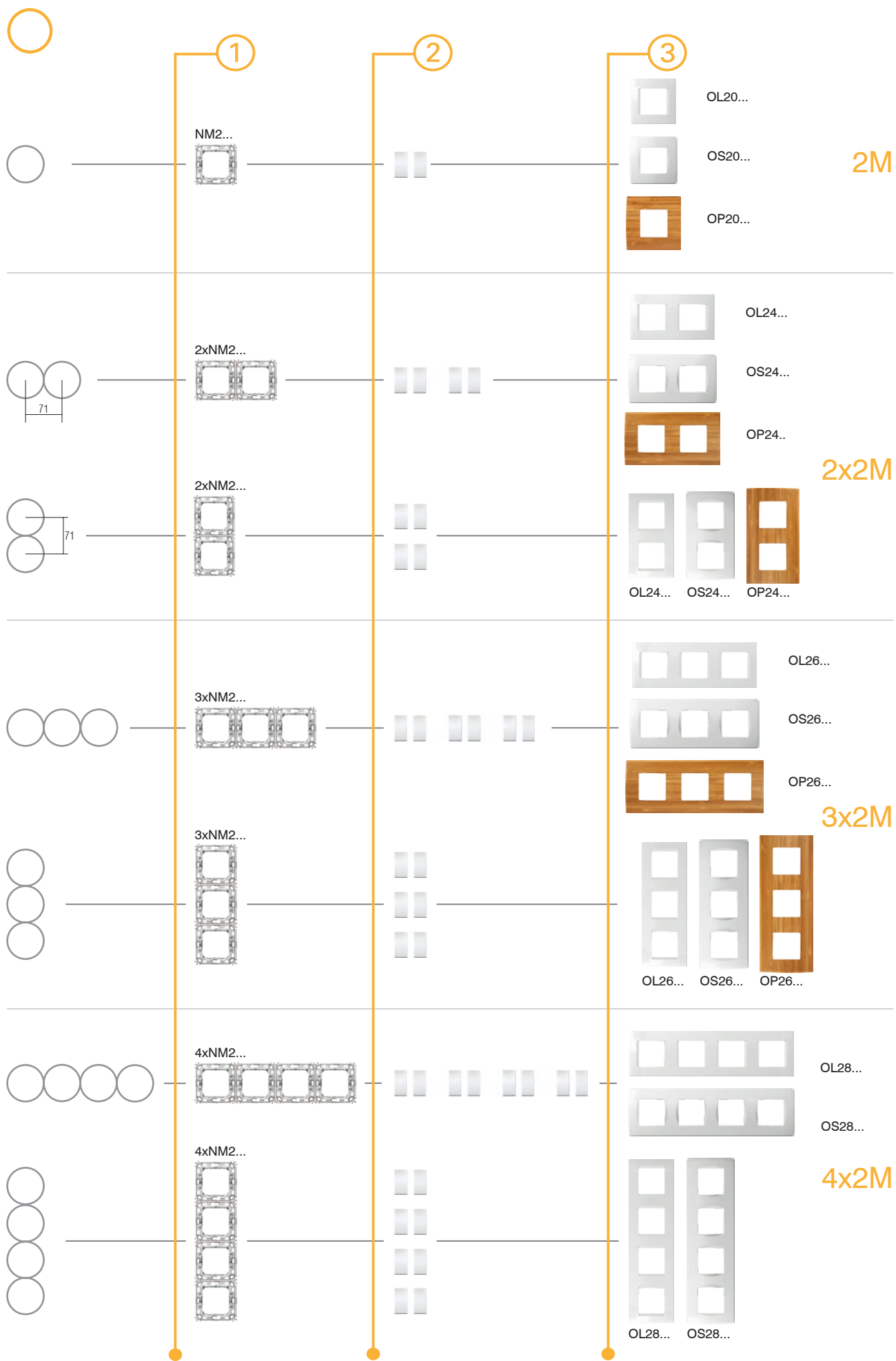

C O M B I N A T I O N S

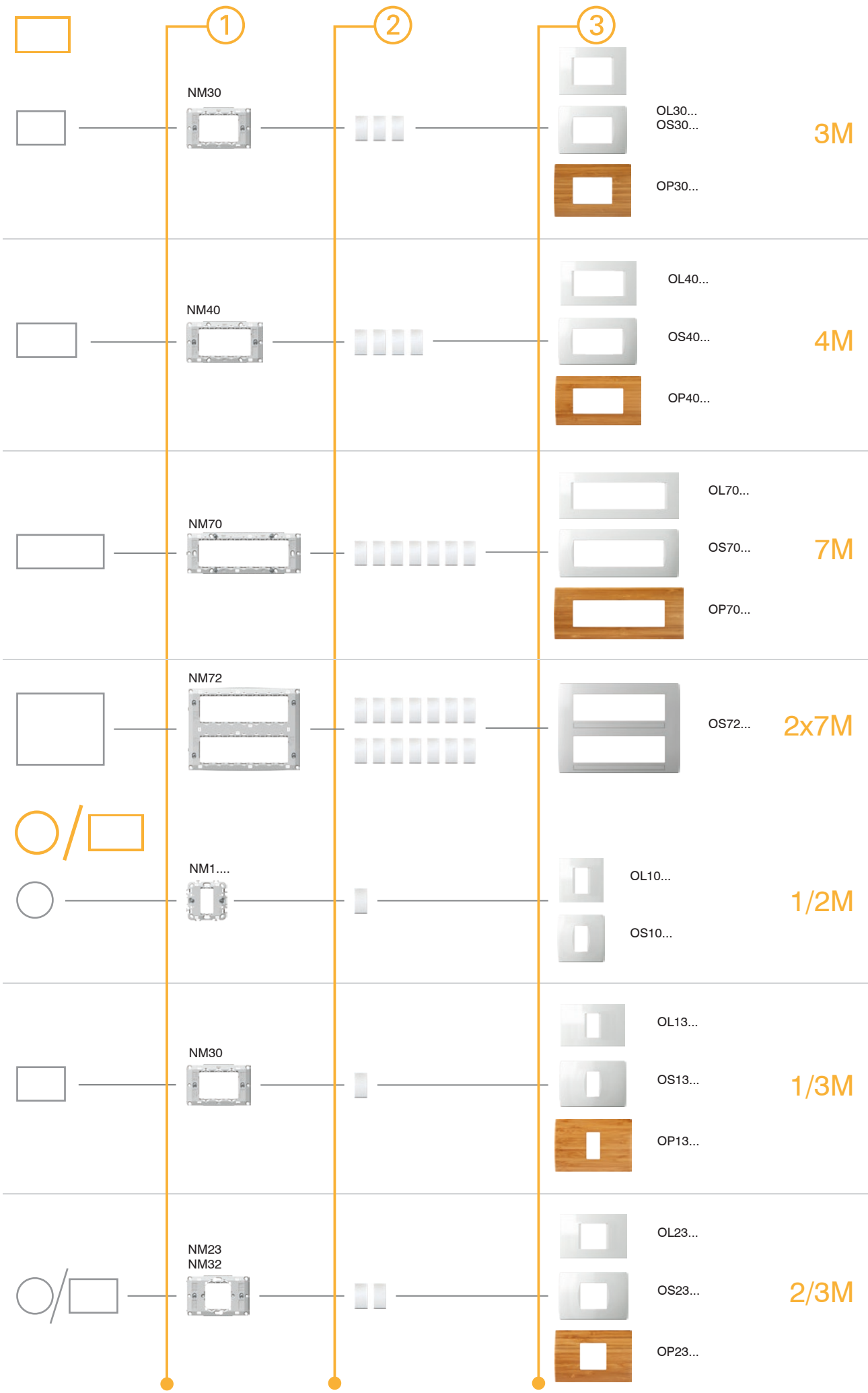

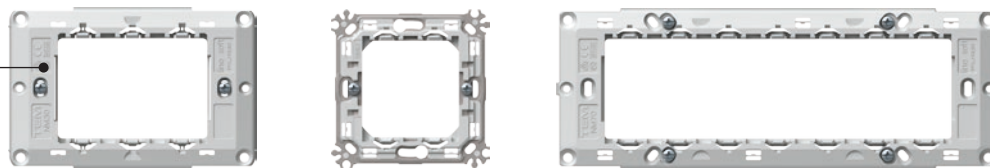

NM30

tip type	naziv description	veličina size
NM10	NOSAČ S NOŽICAMA MOUNTING FRAME WITH CLAWS	1/2M
NM11	NOSAČ BEZ VIJAKA MOUNTING FRAME WITHOUT SCREWS	1/2M
NM20	NOSAČ S NOŽICAMA MOUNTING FRAME WITH CLAWS	2M
...



NOSAČ S NOŽICAMA 2M

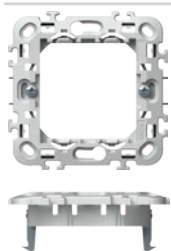

NM20

- nosač s nožicama 2M
- za ugradnju u kutije Ø60 (DE..) s nožicama
- moguće kombinacije vodoravne ili okomite ugradnje 2x2M, 3x2M i 4x2M
- prikladno za kombiniranje s okvirima LINE i SOFT
- sukladno normi EN 60669-1

MOUNTING FRAME WITH CLAWS 2M

- mounting frame 2M with claws
- for mounting on boxes Ø60 (DE..) with claws
- possible horizontal or vertical combinations 2x2M, 3x2M and 4x2M
- suitable for assembling with cover plates LINE and SOFT
- in accordance with EN 60669-1

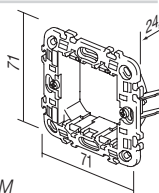

NOSAČ BEZ VIJAKA 2M

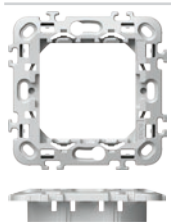

NM21

- nosač 2M bez vijaka i bez nožica
- za ugradnju u kutije Ø60 (HE.., BE..) s vijcima
- moguće kombinacije vodoravne ili okomite ugradnje 2x2M, 3x2M i 4x2M
- prikladno za kombiniranje s okvirima LINE i SOFT
- sukladno normi EN 60669-1

MOUNTING FRAME WITHOUT SCREWS 2M

- mounting frame 2M without screws and without claws
- for mounting on boxes Ø60 (HE.., BE..) with screws
- possible horizontal or vertical combinations 2x2M, 3x2M and 4x2M
- suitable for assembling with cover plates LINE and SOFT
- in accordance with EN 60669-1

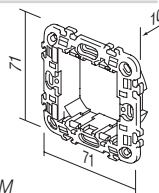

NOSAČ METALNI S NOŽICAMA 2M

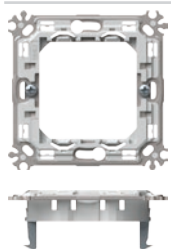

NM24

- metalni nosač 2M s nožicama - kruta inačica
- za ugradnju u kutije Ø60 (DE..) s nožicama
- moguće kombinacije vodoravne ili okomite ugradnje 2x2M, 3x2M i 4x2M
- prikladno za kombiniranje s okvirima PURE, LINE i SOFT
- sukladno normi EN 60669-1

MOUNTING FRAME METAL WITH CLAWS 2M

- metal mounting frame 2M with claws - stiff version
- for mounting on boxes Ø60 (DE..) with claws
- possible horizontal or vertical combinations 2x2M, 3x2M and 4x2M
- suitable for assembling with cover plates PURE, LINE and SOFT
- in accordance with EN 60669-1

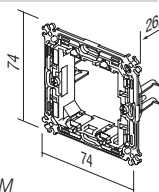

NOSAČ METALNI BEZ VIJAKA 2M

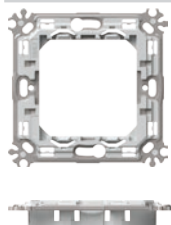

NM25

- metalni nosač 2M bez vijaka i bez nožica - kruta inačica
- za ugradnju u kutije Ø60 (HE.., BE..) s nožicama
- moguće kombinacije vodoravne ili okomite ugradnje 2x2M, 3x2M i 4x2M
- prikladno za kombiniranje s okvirima PURE, LINE i SOFT
- sukladno normi EN 60669-1

MOUNTING FRAME METAL WITHOUT SCREWS 2M

- metal mounting frame 2M without screws and without claws - stiff version
- for mounting on boxes Ø60 (HE.., BE..) with claws
- possible horizontal or vertical combinations 2x2M, 3x2M and 4x2M
- suitable for assembling with cover plates PURE, LINE and SOFT
- in accordance with EN 60669-1

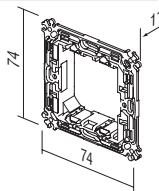



NM30

NOSAČ S VIJCIMA 3M

- nosač 3M s vijcima
- za ugradnju u pravokutne kutije 3M
- prikladno za kombiniranje s okvirima PURE, LINE i SOFT
- sukladno normi EN 60669-1

MOUNTING FRAME WITH SCREWS 3M

- mounting frame 3M with screws
- for mounting on rectangular boxes 3M
- suitable for assembling with cover plates PURE, LINE and SOFT
- in accordance with EN 60669-1

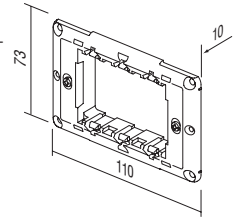

NM40

NOSAČ S VIJCIMA 4M

- nosač 4M s vijcima
- za ugradnju u pravokutne kutije 4M
- prikladno za kombiniranje s okvirima PURE, LINE i SOFT
- sukladno normi EN 60669-1

MOUNTING FRAME WITH SCREWS 4M

- mounting frame 4M with screws
- for mounting on rectangular boxes 4M
- suitable for assembling with cover plates PURE, LINE and SOFT
- in accordance with EN 60669-1

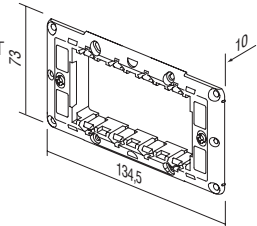

NM70

NOSAČ S VIJCIMA 7M

- nosač 7M s vijcima
- za ugradnju u pravokutne kutije 7M
- prikladno za kombiniranje s okvirima PURE, LINE i SOFT
- sukladno normi EN 60669-1

MOUNTING FRAME WITH SCREWS 7M

- mounting frame 7M with screws
- for mounting on rectangular boxes 7M
- suitable for assembling with cover plates PURE, LINE and SOFT
- in accordance with EN 60669-1

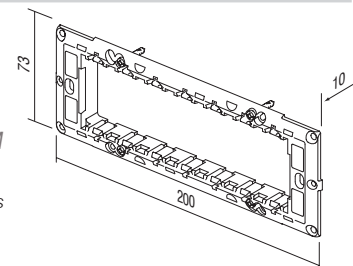

NM72

NOSAČ S VIJCIMA 2x7M

- nosač 2x7M s vijcima
- za ugradnju u pravokutne kutije 2x7M
- prikladan za sastavljanje s okvirom SOFT OS72
- sukladno normi EN 60669-1

MOUNTING FRAME WITH SCREWS 2x7M

- mounting frame 2x7M with screws
- for mounting on rectangular boxes 2x7M
- suitable for assembling with cover plate SOFT OS72
- in accordance with EN 60669-1

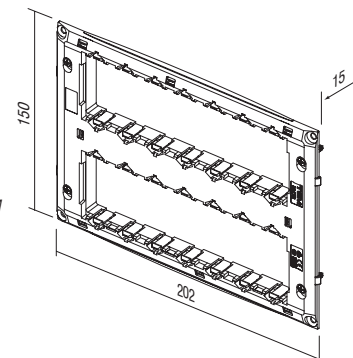



NOSAČ S NOŽICAMA 1/2M

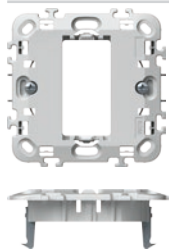

NM10

- nosač 1/2M s nožicama
- za ugradnju u kutije Ø60 (DE..) s nožicama
- prikladno za kombiniranje s okvirima LINE i SOFT
- sukladno normi EN 60669-1

MOUNTING FRAME WITH CLAWS 1/2M

- mounting frame 1/2M with claws
- for mounting on boxes Ø60 (DE..) with claws
- suitable for assembling with cover plates LINE and SOFT
- in accordance with EN 60669-1

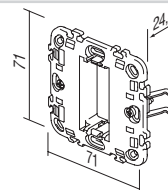

NOSAČ BEZ VIJAKA 1/2M

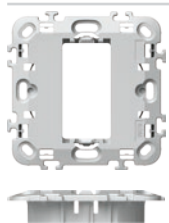

NM11

- nosač 1/2M bez vijaka i bez nožica
- za ugradnju u kutije Ø60 (HE.., BE..) s vijcima
- prikladno za kombiniranje s okvirima LINE i SOFT
- sukladno normi EN 60669-1

MOUNTING FRAME WITHOUT SCREWS 1/2M

- mounting frame 1/2M without screws and without claws
- for mounting on boxes Ø60 (HE.., BE..) with screws
- suitable for assembling with cover plates LINE and SOFT
- in accordance with EN 60669-1

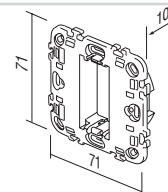

NOSAČ S NOŽICAMA 2/3M

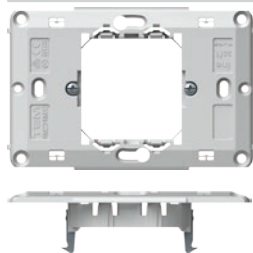

NM23

- nosač 2/3M s nožicama
- za ugradnju u kutije Ø60 (DE..) s nožicama
- prikladno za kombiniranje s okvirima PURE, LINE i SOFT
- sukladno normi EN 60669-1

MOUNTING FRAME WITH CLAWS 2/3M

- mounting frame 2/3M with claws
- for mounting on boxes Ø60 (DE..) with claws
- suitable for assembling with cover plates PURE, LINE and SOFT
- in accordance with EN 60669-1

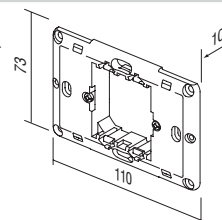

NOSAČ S VIJCIMA 2/3M

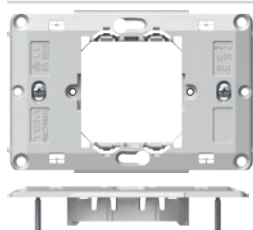

NM32

- nosač 2/3M s vijcima
- za ugradnju u pravokutne kutije 3M
- prikladno za kombiniranje s okvirima PURE, LINE i SOFT
- sukladno normi EN 60669-1

MOUNTING FRAME WITH SCREWS 2/3M

- mounting frame 2/3M with screws
- for mounting on rectangular boxes 3M
- suitable for assembling with cover plates PURE, LINE and SOFT
- in accordance with EN 60669-1

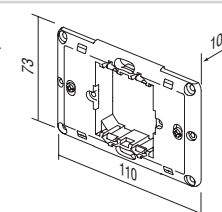

TEM

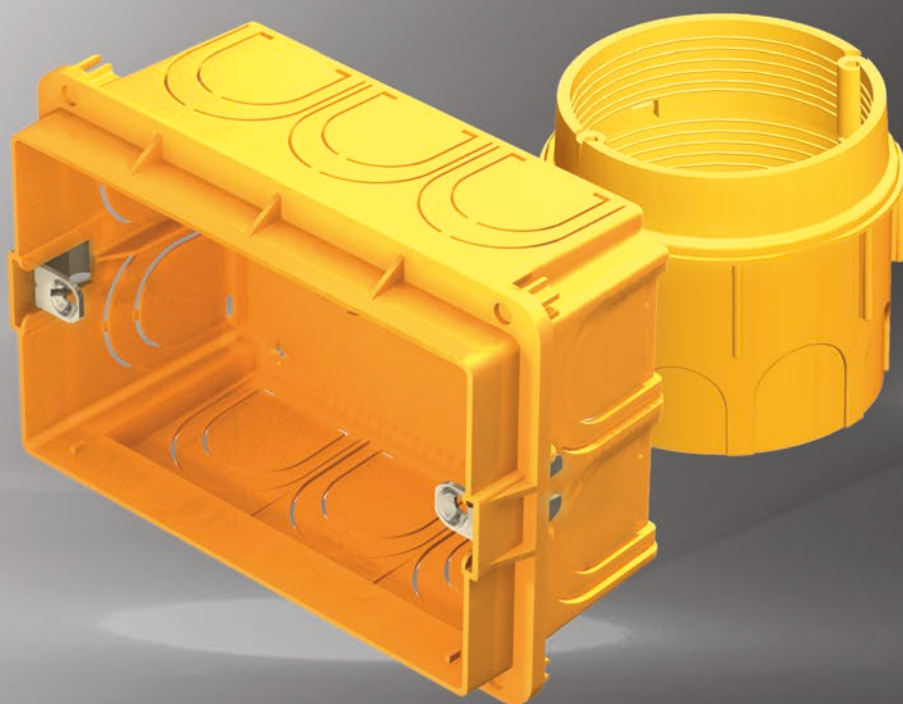



KUTIJE OKRUGLE
ROUND BOXES



126

KUTIJE PRAVOKUTNE
RECTANGULAR BOXES



134

KUTIJE PRIKLJUČNE
JUNCTION BOXES



142

PRIBOR ZA OŽIČENJE
WIRING ACCESSORIES

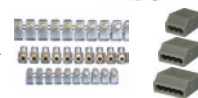

144

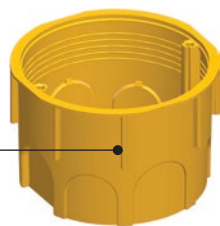

DE12



HE11

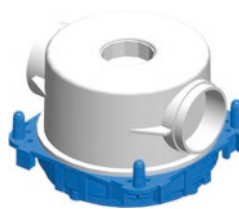

BE10

tip type	naziv description	veličina size
DE10	KUTIJA OKRUGLA ZA ZID OD OPEKE ROUND BOX BRICK	SM60-01
HE10	KUTIJA OKRUGLA ZA ŠUPLJE ZIDOVE ROUND BOX HOLLOW WALL	SM68X40
BE10	KUTIJA OKRUGLA ZA BETON ROUND BOX CONCRETE	
...

KUTIJA OKRUGLA ZA ZID OD OPEKE SM60-01



DE10

- Ø60, dubina 40mm
- 650°C, 500V ~
- sukladno normi IEC 60670-1
- bez halogena

ROUND BOX BRICK SM60-01

- Ø60, depth 40mm
- 650°C, 500V~
- in accordance with IEC 60670-1
- halogen free

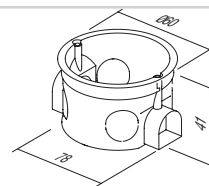

KUTIJA OKRUGLA ZA ZID OD OPEKE DUBOKA SM60-06



DE11

- Ø60, dubina 60mm
- 650°C, 500V ~
- sukladno normi IEC 60670-1
- bez halogena

ROUND BOX BRICK DEEP SM60-06

- Ø60, depth 60mm
- 650°C, 500V~
- in accordance with IEC 60670-1
- halogen free

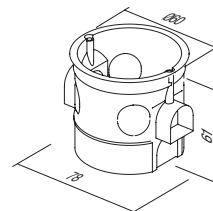

VEZNI ŠLAN SM60-03



DE30

- za okomito povezivanje kutija SM60-06 ili SM60-01 na razmaku od 91 mm
- sukladno normi IEC 60670-1
- bez halogena

COMBI-CLIP SM60-03

- for vertical fitting of boxes SM60-06 or SM60-01 on distance 91 mm
- in accordance with IEC 60670-1
- halogen free

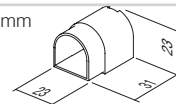

VEZNI ŠLAN SM60-04



DE31







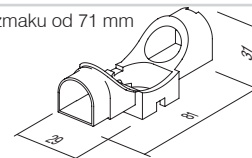



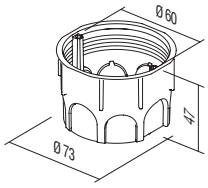
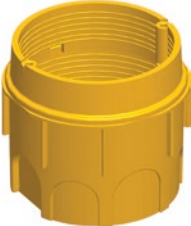
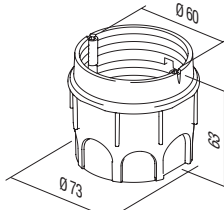

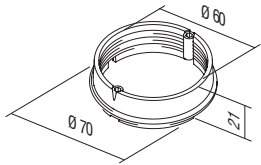
- za vodoravno povezivanje kutija SM60-06 ili SM60-01 na razmaku od 71 mm
- sukladno normi IEC 60670-1
- bez halogena

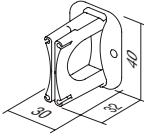
COMBI-CLIP SM60-04

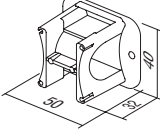
- for horizontal fitting of boxes SM60-06 or SM60-01 on distance 71mm
- in accordance with IEC 60670-1
- halogen free

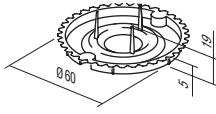

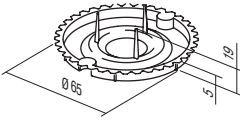
R O U N D B O X E S

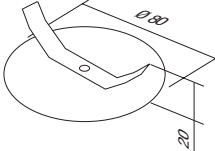
	DE12	KUTIJA OKRUGLA ZA ZID OD OPEKE MD65-46 - Ø65, dubina 46mm - 650°C, 500V ~ - sukladno normi IEC 60670-1 ROUND BOX BRICK MD65-46 - Ø65, depth 46mm - 650°C, 500V~ - in accordance with IEC 60670-1	
	DE13	KUTIJA OKRUGLA ZA ZID OD OPEKE DUBOKA MD65-60 - Ø65/60, dubina 62mm - 650°C, 500V ~ - sukladno normi IEC 60670-1 ROUND BOX BRICK DEEP MD65-60 - Ø65/60, depth 62mm - 650°C, 500V~ - in accordance with IEC 60670-1	
	DE14	PRODUŽETAK ZA MD65-46 - Ø65/60, dubina 17mm - 650°C, 500V ~ - sukladno normi IEC 60670-1 ADDITIONAL PIECE FOR MD65-46 - Ø65/60, depth 17mm - 650°C, 500V~ - in accordance with IEC 60670-1	
	DE32	VEZNI ŠLAN MD65-71 - za povezivanje kutija MD65 na razmaku od 71mm - sukladno normi IEC 60670-1 COMBI-CLIP MD65-71 - for fitting of boxes MD65 on distance 71mm - in accordance with IEC 60670-1	
	DE33	VEZNI ŠLAN MD65-91 - za povezivanje kutija MD65 na razmaku od 91mm - sukladno normi IEC 60670-1 COMBI-CLIP MD65-91 - for fitting of boxes MD65 on distance 91mm - in accordance with IEC 60670-1	
	DE20	POKLOPAC KUTIJE ZAŠTITNI 60 - zaštitni poklopac za kutiju Ø60 za DE13, DE14 - sukladno normi IEC 60670-1 - zaštita kutije tijekom žbukanja BOX COVER PROTECTIVE 60 - protective cover for box Ø60 for DE13, DE14 - in accordance with IEC 60670-1 - box protection during plastering	
	DE21	POKLOPAC KUTIJE ZAŠTITNI 65 - zaštitni poklopac za kutiju Ø65 za DE12 - sukladno normi IEC 60670-1 - zaštita kutije tijekom žbukanja BOX COVER PROTECTIVE 65 - protective cover for box Ø65 for DE12 - in accordance with IEC 60670-1 - box protection during plastering	
	DE22	POKLOPAC KUTIJE DEKORATIVNI SM60 - dekorativni poklopac za kutije Ø60 - sukladno normi IEC 60670-1 - bez halogena BOX COVER DECORATIVE SM60 - decorative cover for boxes Ø60 - in accordance with IEC 60670-1 - halogen free	



K U T I J E

upute za ugradnju /
assembly instructions

razmak između kutija /
distance between boxes: 71mm

razmak između kutija /
distance between boxes: 91mm

DE10,11

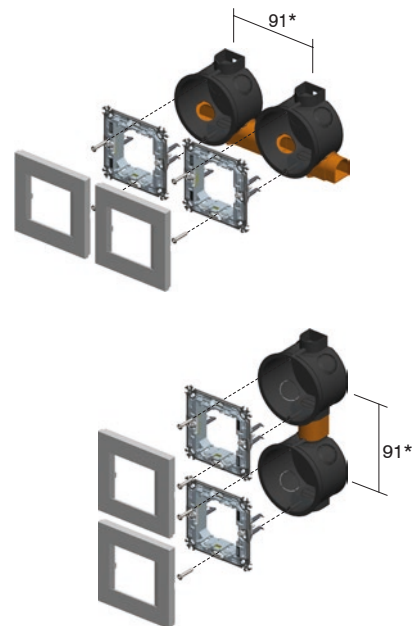
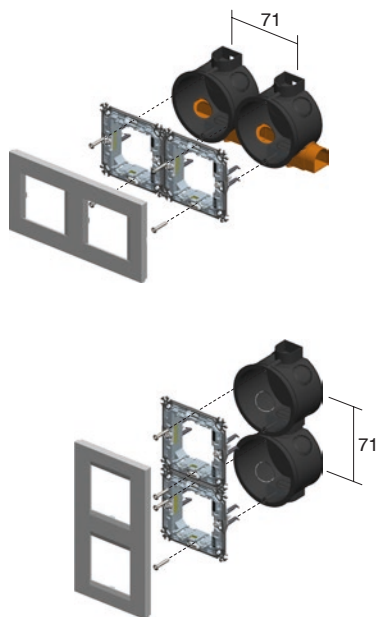
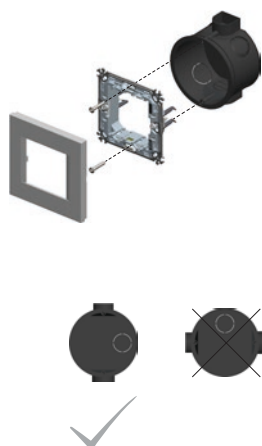

DE12,13

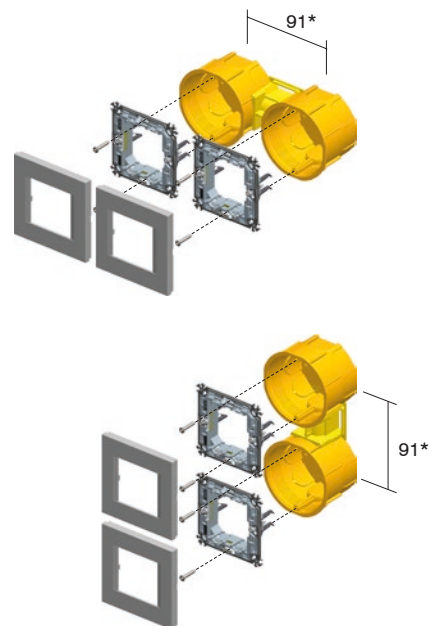
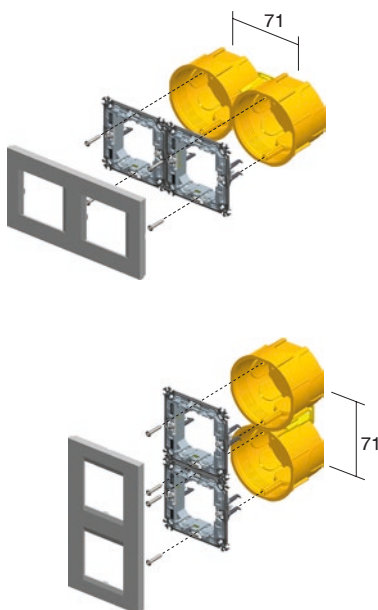
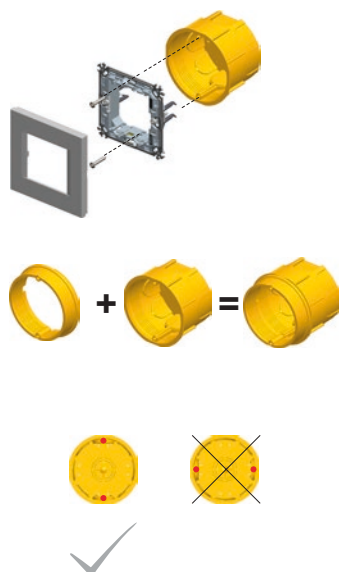

* za okvire PURE, min. razmak između kutija je 100 mm
* for PURE cover plates the minimum distance between boxes is 100mm

R O U N D B O X E S



DE10,11



NM20



DE12,13



NM24



DE10,11



NM10



DE12,13



71

2xDE10,11 + 2xDE31



2xNM20



2xDE12,13 + 1xDE32



2xNM24



2xDE10,11 2xDE12,13 + 1xDE32

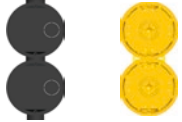

2xNM20



2xNM24

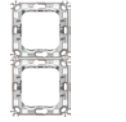

3xDE10,11 + 3xDE31



3xNM20



3xDE12,13 + 2xDE32



3xNM24



3xDE10,11 3xDE12,13 + 2xDE32

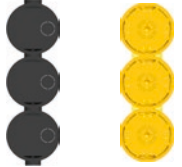

3xNM20



3xNM24

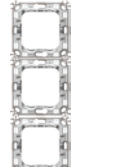

4xDE10,11 + 4xDE31



4xNM20



4xDE12,13 + 3xDE32



4xNM24



4xDE10,11 4xDE12,13 + 3xDE32

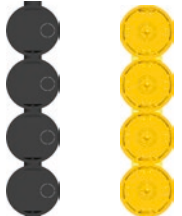

4xNM20



4xNM24

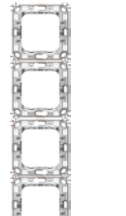



HE10

KUTIJA OKRUGLA ZA ŠUPLJE ZIDOVE SM68x40

- Ø60, dubina 40mm
- ugradni promjer Ø68
- 850°C, 400V ~
- sukladno normi IEC 60670-1
- ugradnja s nožicama
- bez halogena

ROUND BOX HOLLOW WALL SM68x40

- Ø60, depth 40mm
- cutting hole Ø68
- 850°C, 400V~
- in accordance with IEC 60670-1
- mounting with claws
- halogen free

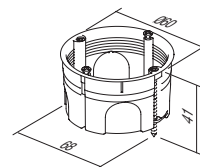

HE11

KUTIJA OKRUGLA ZA ŠUPLJE ZIDOVE SM68x55

- Ø60, dubina 55mm
- ugradni promjer Ø68
- 850°C, 400V ~
- sukladno normi IEC 60670-1
- ugradnja s nožicama
- bez halogena

ROUND BOX HOLLOW WALL SM68x55

- Ø60, depth 55mm
- cutting hole Ø68
- 850°C, 400V~
- in accordance with IEC 60670-1
- mounting with claws
- halogen free

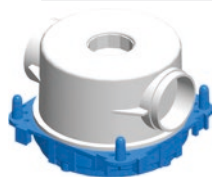
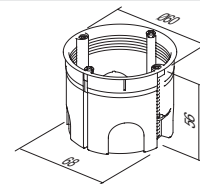

BE10

KUTIJA OKRUGLA ZA BETON

- Ø60 mm, dubina 49 mm
- 650°C, 500V ~
- sukladno normi IEC 60670-1

ROUND BOX CONCRETE

- Ø60mm, depth 49mm
- 650°C, 500V~
- in accordance with IEC 60670-1

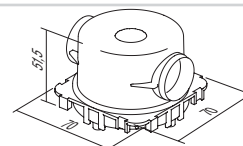

BE11

KUTIJA OKRUGLA ZA BETON DUBOKA

- Ø60 mm, dubina 58mm
- 650°C, 500V ~
- sukladno normi IEC 60670-1

ROUND BOX CONCRETE DEEP

- Ø60mm, depth 58mm
- 650°C, 500V~
- in accordance with IEC 60670-1

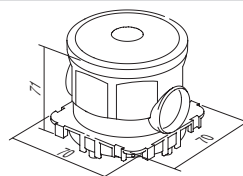

BE20

NOSAČ KUTIJE ZA BETON

- za učvršćivanje doze dilatacijskim profilom BM82 u suprotni zid
- sukladno normi IEC 60670-1

COUNTER BOX SUPPORT CONCRETE

- to support concrete boxes with discance profile BM82 for extreme loads
- in accordance with IEC 60670-1

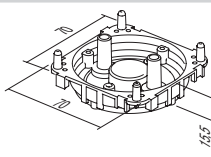

BE21

UVODNICA ZA KUTIJU ZA BETON 16

- za učvršćivanje instalacijske cijevi
- sukladno normi IEC 60670-1

PIPE STOPPER CONCRETE BOX 16

- for firming installation pipe to box
- in accordance with IEC 60670-1

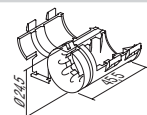

R O U N D

B O X E S

šuplji zidovi / hollow walls



beton / concrete



upute za ugradnju /
assembly instructions

razmak između kutija /
distance between boxes: 71mm

razmak između kutija /
distance between boxes: 91mm

HE10,11

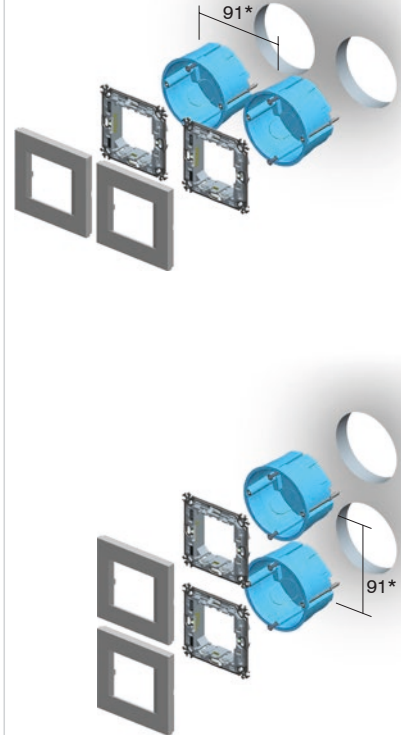
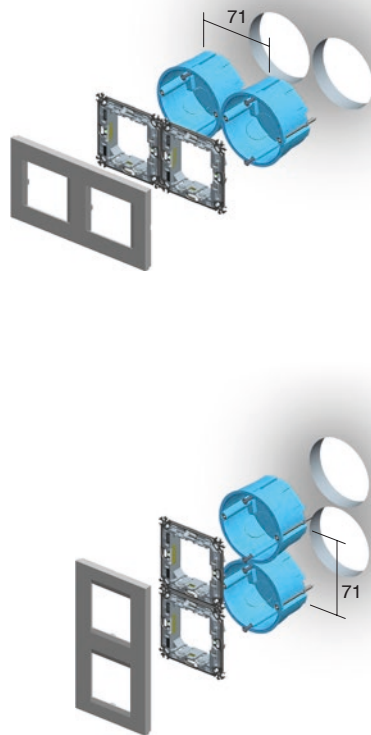
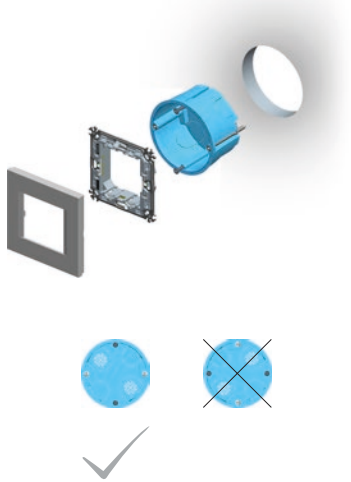

BE10

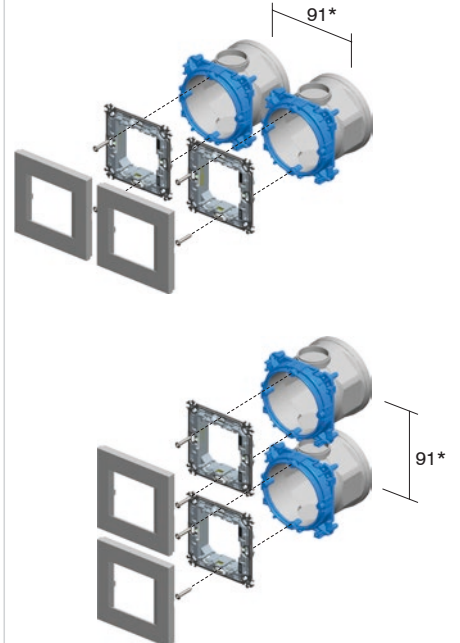
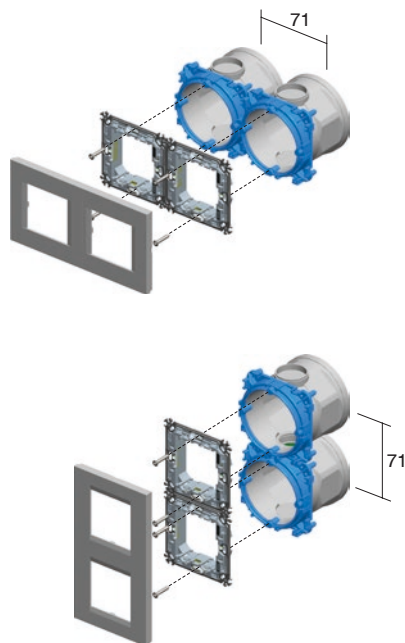
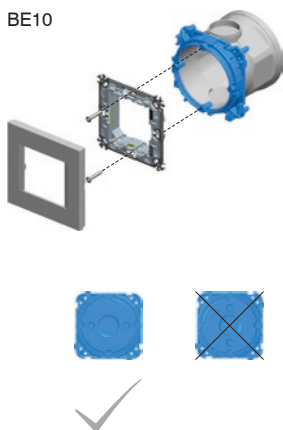

* za okvire PURE, min. razmak između kutija je 100 mm

* for PURE cover plates the minimum distance between boxes is 100mm

šuplji zidovi / hollow walls



beton / concrete



HE10,11



BE10,11



NM21



NM25



2M

HE10,11



BE10,11



NM11



1/2M

2xHE10,11



2xBE10,11



2xNM21



2xNM25



2x2M

HE10,11



BE10,11



NM32



2/3M

2xHE10,11



2xBE10,11



2xNM21



2xNM25



3xHE10,11



3xBE10,11



3xNM21



3xNM25



3x2M

3xHE10,11



3xBE10,11



3xNM21



3xNM25



4xHE10,11



4xBE10,11



4xNM21



4xNM25



4x2M

4xHE10,11



4xBE10,11



4xNM21



4xNM25



R O U N D B O X E S

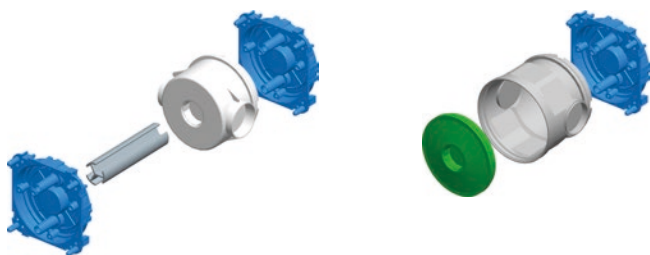

upute za ugradnju /
assembly instructions

1

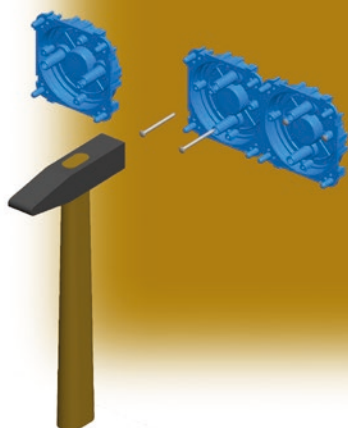

3

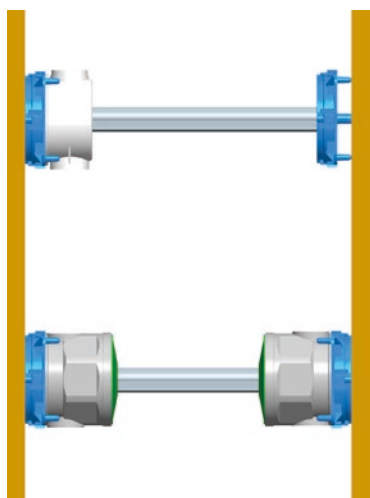

2

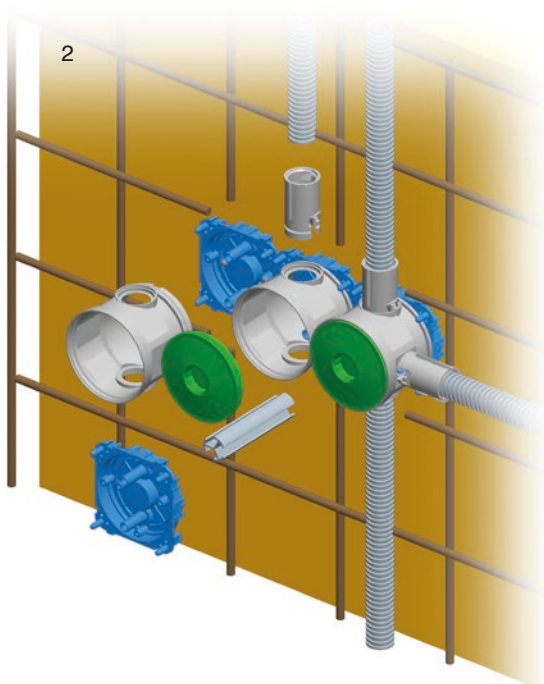

4

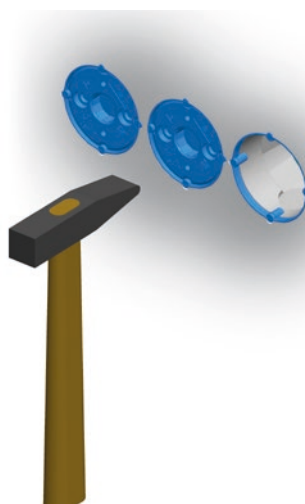

K U T I J E P R A V O K U T N E

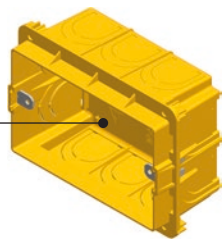

DM30



HM30

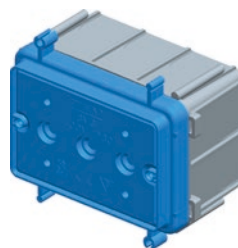

BM30

tip type	naziv description	veličina size
DM30	KUTIJA PRAVOKUTNA ZA ZID OD OPEKE RECTANGULAR BOX BRICK	PM3
HM30	KUTIJA PRAVOKUTNA ZA ŠUPLJE ZIDOVE VM3 RECTANGULAR BOX HOLLOW WALL	VM3
BM30	KUTIJA PRAVOKUTNA ZA BETON RECTANGULAR BOX CONCRETE	BM3
...

KUTIJA PRAVOKUTNA ZA ZID OD OPEKE PM3



DM30

- veličina 3M, dubina 49 mm
- 650°C, 400V ~
- sukladno normi IEC 60670-1
- bez halogena

RECTANGULAR BOX BRICK PM3

- size 3M, depth 49mm
- 650°C, 400V~
- in accordance with IEC 60670-1
- halogen free

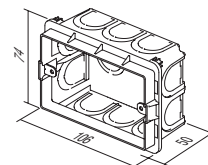

KUTIJA PRAVOKUTNA ZA ZID OD OPEKE PM3-65



DM31

- veličina 3M, dubina 65mm
- 650°C, 400V ~
- sukladno normi IEC 60670-1
- bez halogena

RECTANGULAR BOX BRICK PM3-65

- size 3M, depth 65mm
- 650°C, 400V~
- in accordance with IEC 60670-1
- halogen free

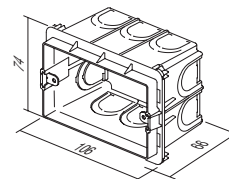

KUTIJA PRAVOKUTNA ZA ZID OD OPEKE PM4



DM40

- veličina 4M, dubina 49 mm
- 650°C, 400V ~
- sukladno normi IEC 60670-1
- bez halogena

RECTANGULAR BOX BRICK PM4

- size 4M, depth 49mm
- 650°C, 400V~
- in accordance with IEC 60670-1
- halogen free

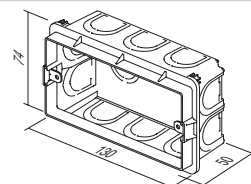

KUTIJA PRAVOKUTNA ZA ZID OD OPEKE PM4-65

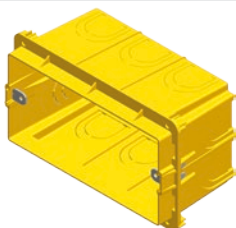

DM41

- veličina 4M, dubina 65mm
- 650°C, 400V ~
- sukladno normi IEC 60670-1
- bez halogena

RECTANGULAR BOX BRICK PM4-65

- size 4M, depth 65mm
- 650°C, 400V~
- in accordance with IEC 60670-1
- halogen free

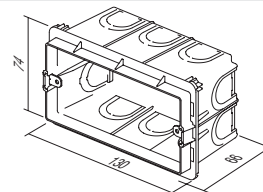

R E C T A N G U L A R B O X E S

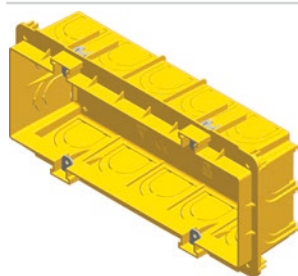

DM70

KUTIJA PRAVOKUTNA ZA ZID OD OPEKE PM7

- veličina 7M, dubina 49 mm
- 650°C, 400V ~
- sukladno normi IEC 60670-1
- bez halogena

RECTANGULAR BOX BRICK PM7

- size 7M, depth 49mm
- 650°C, 400V ~
- in accordance with IEC 60670-1
- halogen free

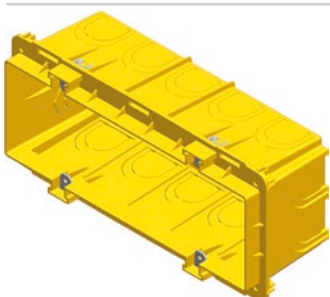
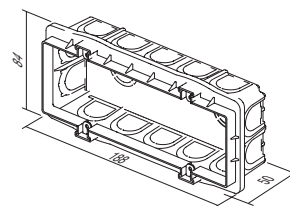

DM71

KUTIJA PRAVOKUTNA ZA ZID OD OPEKE PM7-65

- veličina 7M, dubina 65mm
- 650°C, 400V ~
- sukladno normi IEC 60670-1
- bez halogena

RECTANGULAR BOX BRICK PM7-65

- size 7M, depth 65mm
- 650°C, 400V ~
- in accordance with IEC 60670-1
- halogen free

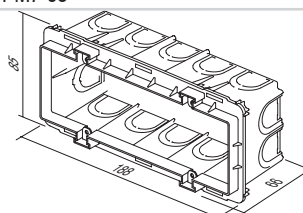

DM72

KUTIJA PRAVOKUTNA ZA ZID OD OPEKE PM72-65

- veličina 2x7M, dubina 64mm
- 650°C, 400V ~
- sukladno normi IEC 60670-1

RECTANGULAR BOX BRICK PM72-65

- size 2x7M, depth 64mm
- 650°C, 400V ~
- in accordance with IEC 60670-1

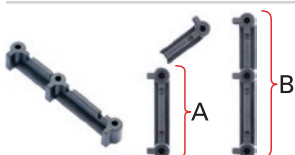
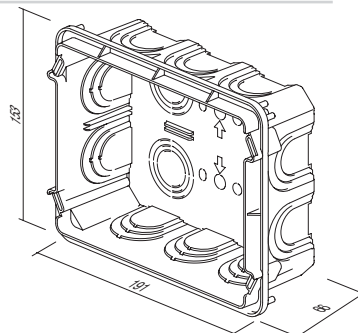

DM80

VEZNI ČLAN KUTIJE PM

- za okomito (B) i vodoravno (A) povezivanje kutija PM3, PM4 i PM7

DISTANCE PIECE FOR BOX PM

- for vertical (B) and horizontal (A) fitting of boxes PM3, PM4 and PM7

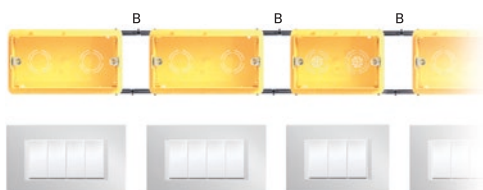
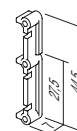



DM33

POKLOPAC KUTIJE ZAŠTITNI PM3

- zaštitni poklopac za kutiju PM3
- sukladno normi IEC 60670-1
- bez halogena
- zaštita kutije tijekom žbukanja

BOX COVER PROTECTIVE PM3

- protective cover for box PM3
- in accordance with IEC 60670-1
- halogen free
- box protection during plastering

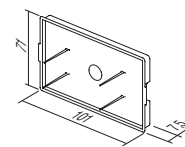

DM34

POKLOPAC KUTIJE DEKORATIVNI PM3

- dekorativni poklopac za kutije 3M
- vijci priloženi
- sukladno normi IEC 60670-1
- bez halogena

BOX COVER DECORATIVE PM3

- decorative cover for boxes 3M
- screws are included
- in accordance with IEC 60670-1
- halogen free

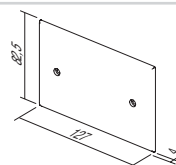

DM43

POKLOPAC KUTIJE ZAŠTITNI PM4

- zaštitni poklopac za kutiju PM4
- sukladno normi IEC 60670-1
- bez halogena
- zaštita kutije tijekom žbukanja

BOX COVER PROTECTIVE PM4

- protective cover for box PM4
- in accordance with IEC 60670-1
- halogen free
- box protection during plastering

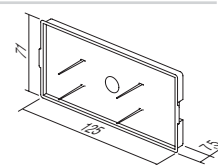

DM44

POKLOPAC KUTIJE DEKORATIVNI PM4

- dekorativni poklopac za kutije 4M
- vijci priloženi
- sukladno normi IEC 60670-1
- bez halogena

BOX COVER DECORATIVE PM4

- decorative cover for boxes 4M
- screws are included
- in accordance with IEC 60670-1
- halogen free

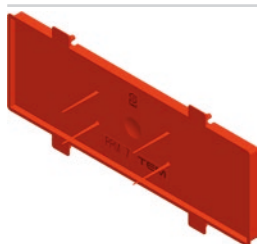
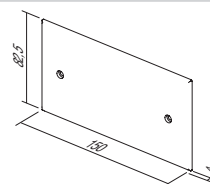

DM73

POKLOPAC KUTIJE ZAŠTITNI PM7

- zaštitni poklopac za kutiju PM7
- sukladno normi IEC 60670-1
- bez halogena
- zaštita kutije tijekom žbukanja

BOX COVER PROTECTIVE PM7

- protective cover for box PM7
- in accordance with IEC 60670-1
- halogen free
- box protection during plastering

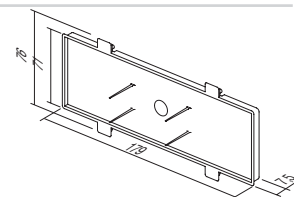

DM74

POKLOPAC KUTIJE DEKORATIVNI PM7

- dekorativni poklopac za kutije 7M
- vijci priloženi
- sukladno normi IEC 60670-1
- bez halogena

BOX COVER DECORATIVE PM7

- decorative cover for boxes 7M
- screws are included
- in accordance with IEC 60670-1
- halogen free

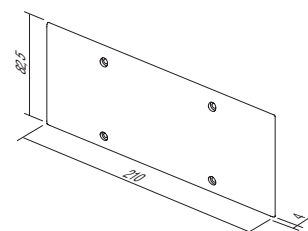

R E C T A N G U L A R B O X E S



DM75

POKLOPAC KUTIJE DEKORATIVNI PM72

- dekorativni poklopac za kutije 2x7M
- vijci priloženi
- sukladno normi IEC 60670-1

BOX COVER DECORATIVE PM72

- decorative cover for boxes 2x7M
- screws are included
- in accordance with IEC 60670-1

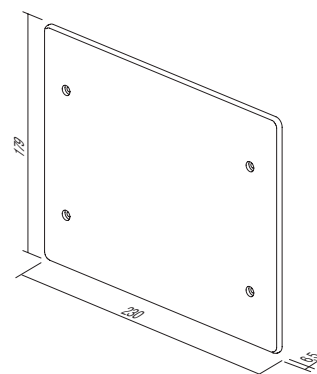



HM30

KUTIJA PRAVOKUTNA ZA ŠUPLJE ZIDOVE VM3

- veličina 3M, dubina 49 mm
- ugradni promjer 2xØ68/45mm
- 850°C, 400V ~
- sukladno normi IEC 60670-1
- bez halogena

RECTANGULAR BOX HOLLOW WALL VM3

- size 3M, depth 49mm
- cutting hole 2xØ68/45mm
- 850°C, 400V~
- in accordance with IEC 60670-1
- halogen free

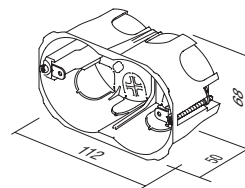

HM40

KUTIJA PRAVOKUTNA ZA ŠUPLJE ZIDOVE VM4

- veličina 4M, dubina 49 mm
- ugradni promjer 2xØ68/70mm
- 850°C, 400V ~
- sukladno normi IEC 60670-1
- bez halogena

RECTANGULAR BOX HOLLOW WALL VM4

- size 4M, depth 49mm
- cutting hole 2xØ68/70mm
- 850°C, 400V~
- in accordance with IEC 60670-1
- halogen free

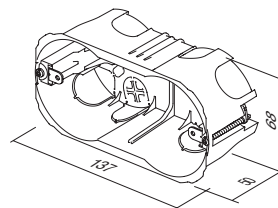

HM70

KUTIJA PRAVOKUTNA ZA ŠUPLJE ZIDOVE VM7

- veličina 7M, dubina 49 mm
- ugradni promjer 2xØ68/120mm
- 850°C, 400V ~
- sukladno normi IEC 60670-1
- bez halogena

RECTANGULAR BOX HOLLOW WALL VM7

- size 7M, depth 49mm
- cutting hole 2xØ68/120mm
- 850°C, 400V~
- in accordance with IEC 60670-1
- halogen free

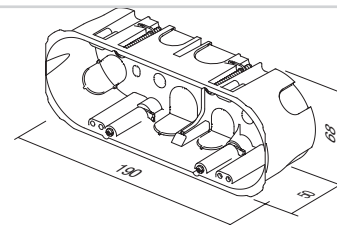

HM72

KUTIJA PRAVOKUTNA ZA ŠUPLJE ZIDOVE VM72

- veličina 2x7M, dubina 63mm
- 850°C, 400V ~
- sukladno normi IEC 60670-1

RECTANGULAR BOX HOLLOW WALL VM72

- size 2x7M, depth 63mm
- 850°C, 400V~
- in accordance with IEC 60670-1

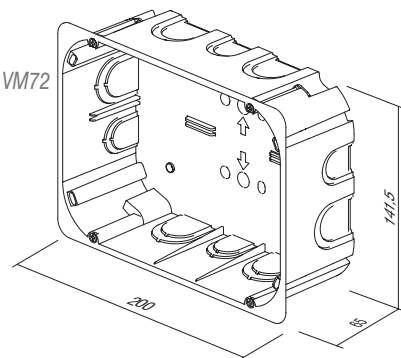

R E C T A N G U L A R B O X E S

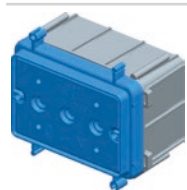

BM30

PRAVOKUTNA KUTIJA ZA BETON BM3

- veličina 3M, dubina 60mm
- 650°C, 400V ~
- sukladno normi IEC 60670-1

RECTANGULAR BOX CONCRETE BM3

- size 3M, depth 60mm
- 650°C, 400V~
- in accordance with IEC 60670-1

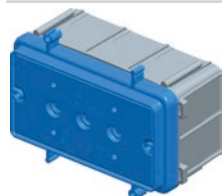
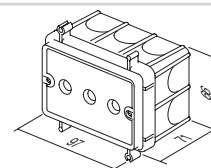

BM40

PRAVOKUTNA KUTIJA ZA BETON BM4

- veličina 4M, dubina 60mm
- 650°C, 400V ~
- sukladno normi IEC 60670-1

RECTANGULAR BOX CONCRETE BM4

- size 4M, depth 60mm
- 650°C, 400V~
- in accordance with IEC 60670-1

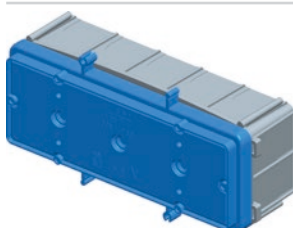
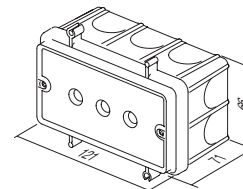

BM70

PRAVOKUTNA KUTIJA ZA BETON BM7

- veličina 7M, dubina 60mm
- 650°C, 400V ~
- sukladno normi IEC 60670-1

RECTANGULAR BOX CONCRETE BM7

- size 7m, depth 60mm
- 650°C, 400V~
- in accordance with IEC 60670-1

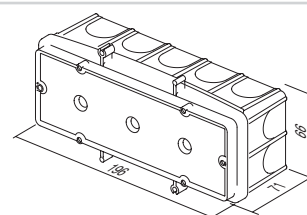

BM80

PRIČVRSNI KOMBI-DRŽAČ BM

- za brzo pričvršćivanje pravokutnih kutija BM na armiranu betonsku šipku
- prikladno za šipku promjera do Ø8 mm

FIXING COMBI-CLIP BM

- for fast fixation of BM rectangular boxes on reinforcing bar
- suitable for bar diameter up to Ø8mm

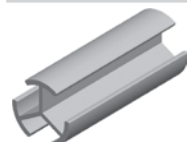
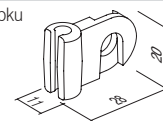

BM82

VEZNI PROFIL ZA KUTIJE BM

- za podupiranje kutija BM s odgovarajućom kutijom na nasuprotnom zidu
- duljina l = 1 m, promjer Ø20 mm

DISTANCE PROFIL FOR BOXES BM

- to support boxes BM with counter box support on opposite wall
- length l = 1m, diameter Ø20mm

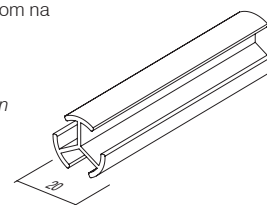

K U T I J E P R A V O K U T N E



cigla / brick



šuplji zidovi / hollow walls



beton / concrete



K U T I J E

DM30		 NM30	3M
HM30			
BM30			
DM40		 NM40	4M
HM40			
BM40			
DM70		 NM70	7M
HM70			
BM70			
DM72		 NM72	2x7M
HM72			
DM30		 NM32	2/3M
HM30			
BM30			

R E C T A N G U L A R B O X E S

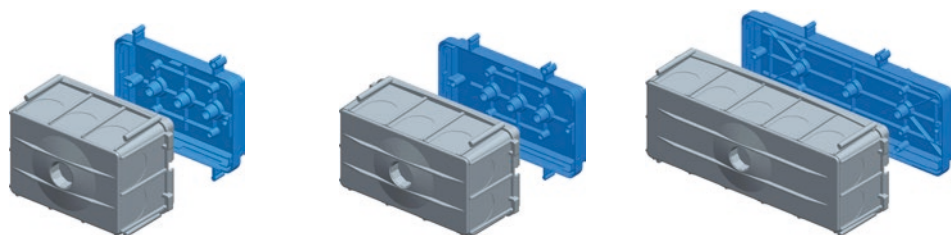

upute za ugradnju /
assembly instructions

1

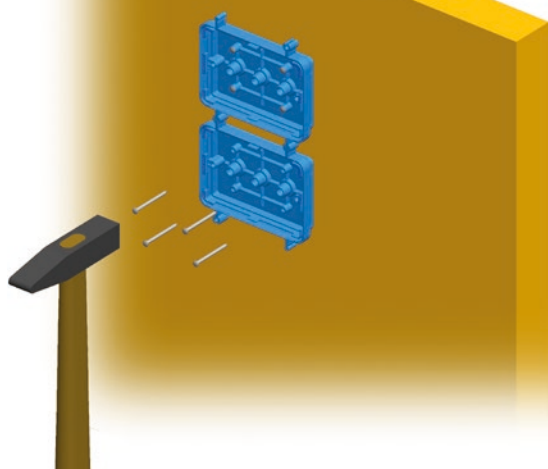

2

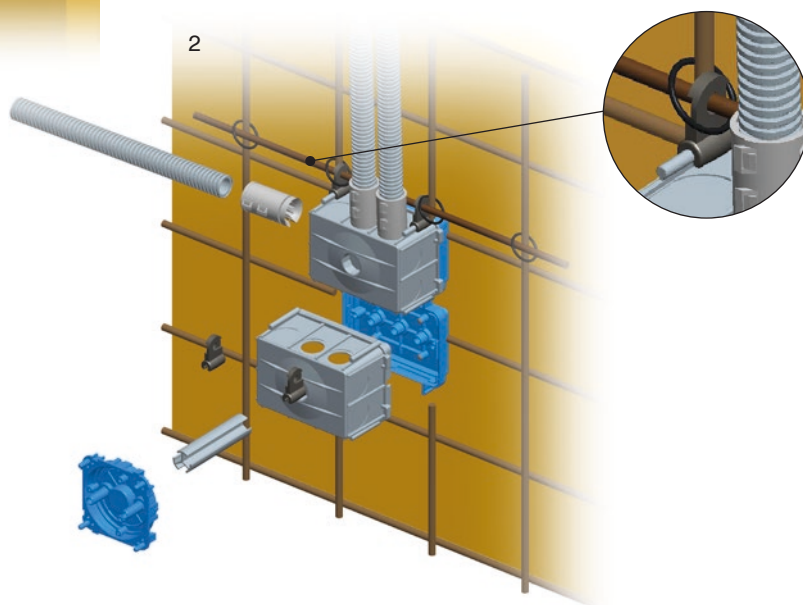

3

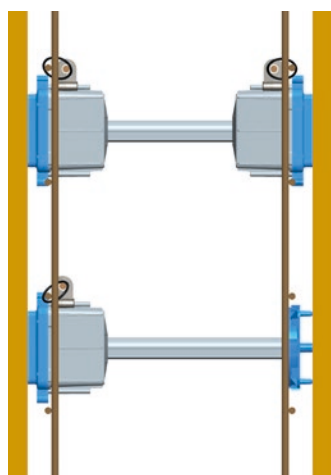

4

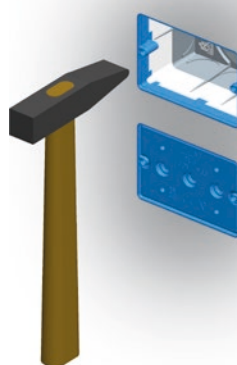



DW10

KUTIJA PRIKLJUČNA OKRUGLA ZA ZID OD OPEKE DSM78

- Ø78, dubina 40mm
- 650°C, 500V ~
- sukladno normama IEC 60670-1 i IEC 60670-22
- bez halogena

CONNECTION ROUND BOX BRICK DSM78

- Ø78, depth 40mm
- 650°C, 500V~
- in accordance with IEC 60670-1 and IEC 60670-22
- halogen free

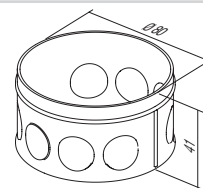

HW10

KUTIJA PRIKLJUČNA OKRUGLA ZA ŠUPLJE ZIDOVE SM78x45

- Ø78, dubina 45mm
- ugradni promjer Ø80
- 850°C, 400V ~
- sukladno normama IEC 60670-1 i IEC 60670-22
- ugradnja s nožicama
- bez halogena

CONNECTION ROUND BOX HOLLOW WALL SM78x45

- Ø78, depth 45mm
- cutting hole Ø80
- 850°C, 400V~
- in accordance with IEC 60670-1 and IEC 60670-22
- mounting with claws
- halogen free

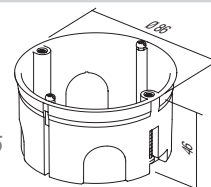

DE23

POKLOPAC KUTIJE DEKORATIVNI SM78

- dekorativni poklopac za kutije Ø78
- sukladno normama IEC 60670-1 i IEC 60670-22
- bez halogena

BOX COVER DECORATIVE SM78

- decorative cover for boxes Ø78
- in accordance with IEC 60670-1 and IEC 60670-22
- halogen free

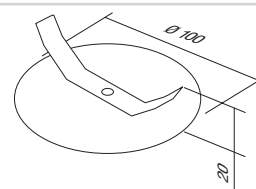

DE24

POKLOPAC KUTIJE ZAŠTITNI 78

- zaštitni poklopac za kutije Ø78
- sukladno normama IEC 60670-1 i IEC 60670-22
- bez halogena

BOX COVER PROTECTIVE 78

- protective cover for box Ø78
- in accordance with IEC 60670-1 and IEC 60670-22
- halogen free

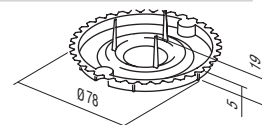

HW20

KUTIJA PRIKLJUČNA ČETVRTASTA ZA ZID OD OPEKE SM105x105

- veličina 105x105mm, dubina 50mm
- ugradnja u rupu prema priloženoj šabloni
- 850°C, 400V ~
- sukladno normama IEC 60670-1 i IEC 60670-22
- ugradnja s nožicama
- bez halogena

CONNECTION SQUARE BOX BRICK SM105x105

- size 105x105mm, depth 50mm
- cutting hole according to attached template
- 850°C, 400V~
- in accordance with IEC 60670-1 and IEC 60670-22
- mounting with claws
- halogen free

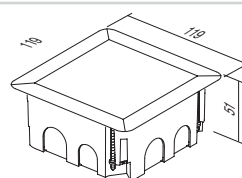

R E C T A N G U L A R B O X E S

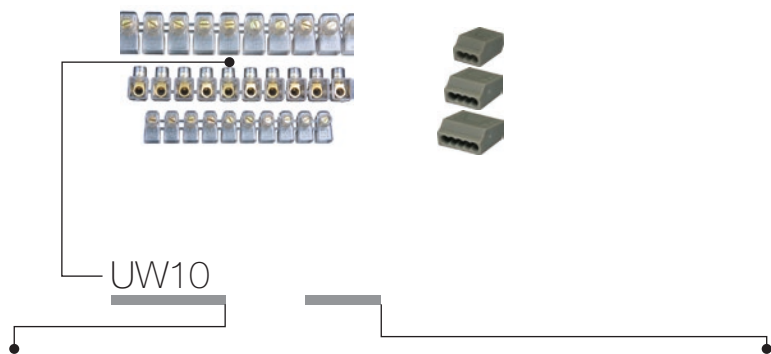

tip type	naziv description	tehnički podaci technical data	veličina size	boja colour
UW10	JEDNOREDNE STEZALJKE 1 ROW TERMINAL BLOCKS	2x2.5mm ²	10P	<input checked="" type="checkbox"/> TS transparentna transparent
UW11	JEDNOREDNE STEZALJKE 1 ROW TERMINAL BLOCKS	2x4mm ²	10P	<input type="checkbox"/> CO boja colour
UW12	JEDNOREDNE STEZALJKE 1 ROW TERMINAL BLOCKS	2x6mm ²	10P	<input type="checkbox"/> WH bijela white
...	<input type="checkbox"/> GY siva grey

JEDNOREDNE STEZALJKE ZATVORENE



- 450V~; 2x2.5mm² ÷ 2x6mm²
- termoplast PC, prozirne
- broj polova: 10

1 ROW TERMINAL BLOCKS CLOSED

- 450V~; 2x2.5mm² ÷ 2x6mm²
- termoplast PC, transparent
- number of poles: 10

UW10TS	(NS12)	2x2.5mm ²	10P
UW11TS	(NS12)	2x4mm ²	10P
UW12TS	(NS12)	2x6mm ²	10P

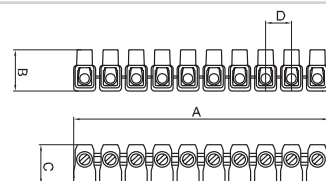

	A	B	C	D
2x2.5 □	110	17.5	17.5	11
2x4 □	128	21	19	12.5
2x6 □	146	21.5	22	15

JEDNOREDNE STEZALJKE

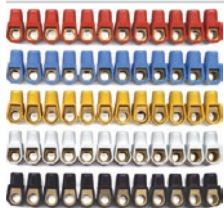

- 450V~; 2x2.5mm² ÷ 2x6mm²
- termoplast PA
- dostupne u raznim bojama
- broj polova: 12

1 ROW TERMINAL BLOCKS

- 450V~; 2x2.5mm² ÷ 2x6mm²
- termoplast PA
- available in different colours
- number of poles: 12

UW15CO	(NS12)	2x2.5mm ²	12P
UW16CO	(NS12)	2x4mm ²	12P
UW17CO	(NS12)	2x6mm ²	12P

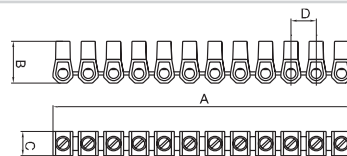

	A	B	C	D
2x2.5 □	110	16.4	9	10
2x4 □	118.8	19	10	10
2x6 □	129.8	21.3	11	11.8

DVOREDNE STEZALJKE

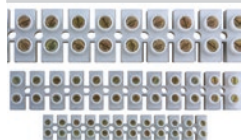

- 450V~; 1.5mm² ÷ 16mm²
- termoplast PA, bijele
- broj polova: 12

2 ROW TERMINAL BLOCKS

- 450V~; 1.5mm² ÷ 16mm²
- termoplast PA, white
- number of poles: 12

UW20WH	(P7)	2.5-4.0mm ²	12P
UW21WH	(P9)	4.0-6.0mm ²	12P
UW22WH	(P12)	6.0-10mm ²	12P
UW23WH	(P14)	16mm ²	12P

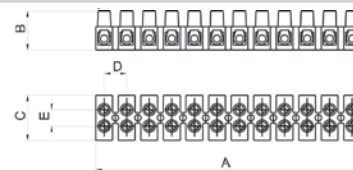

	A	B	C	D	E
2.5-4 □	118	17	20	10	8
4-6 □	129.2	19	22	11	8
6-10 □	147	23	25	12.5	9
16 □	177	29	30	15	13

**BEZVIJČANE REDNE STEZALJKE**

- 24A 450V~, termoplast PA, sive
- broj polova: 3÷8
- bezvijčani kontakti 0,5 ÷ 1,5 mm², za tvrde žice
- sukladno normi EN 60998-1

PLUG-IN WIRE CONNECTORS

- 24A 450V~, thermoplast PA, grey
- number of poles: 3÷8
- plug-in contacts 0,5÷1,5mm², for rigide wires
- in accordance with EN 60998-1

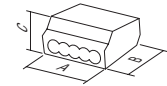

UW40GY	PC153	1.5mm ²	3P	3P	A 12	B 18	C 9
UW41GY	PC155	1.5mm ²	5P	5P	17	18	9
UW42GY	PC158	1.5mm ²	8P	8P	26	18	9

**BEZVIJČANE REDNE STEZALJKE**

- 24A 450V~, termoplast PA, sive
- broj polova: 3÷5
- bezvijčani kontakti 1,5 ÷ 2,5 mm², za tvrde žice
- sukladno normi EN 60998-1

PLUG-IN WIRE CONNECTORS

- 24A 450V~, thermoplast PA, grey
- number of poles: 3÷5
- plug-in contacts 1,5÷2,5mm², for rigide wires
- in accordance with EN 60998-1

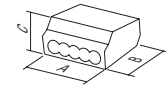

UW45GY	PC253	2.5mm ²	3P	3P	A 14	B 19	C 9
UW46GY	PC254	2.5mm ²	4P	4P	17	19	9
UW47GY	PC255	2.5mm ²	5P	5P	21	19	9

**BEZVIJČANE REDNE STEZALJKE**

- 24A 450V~, termoplast PA, sive
- broj polova: 2 (tvrda žica) + 1 (meka žica)
- bezvijčani kontakti 1,5 ÷ 2,5mm²
- sukladno normi EN 60998-1

PLUG-IN WIRE CONNECTOR

- 24A 450V~, thermoplast PA, grey
- number of poles: 2 (rigide wire) + 1 (soft wire)
- plug-in contacts 1,5÷2,5mm²
- in accordance with EN 60998-1

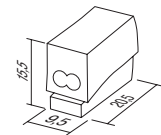

UW50WH	PC302	2.5mm ²	2/1P				
--------	-------	--------------------	------	--	--	--	--

TEM

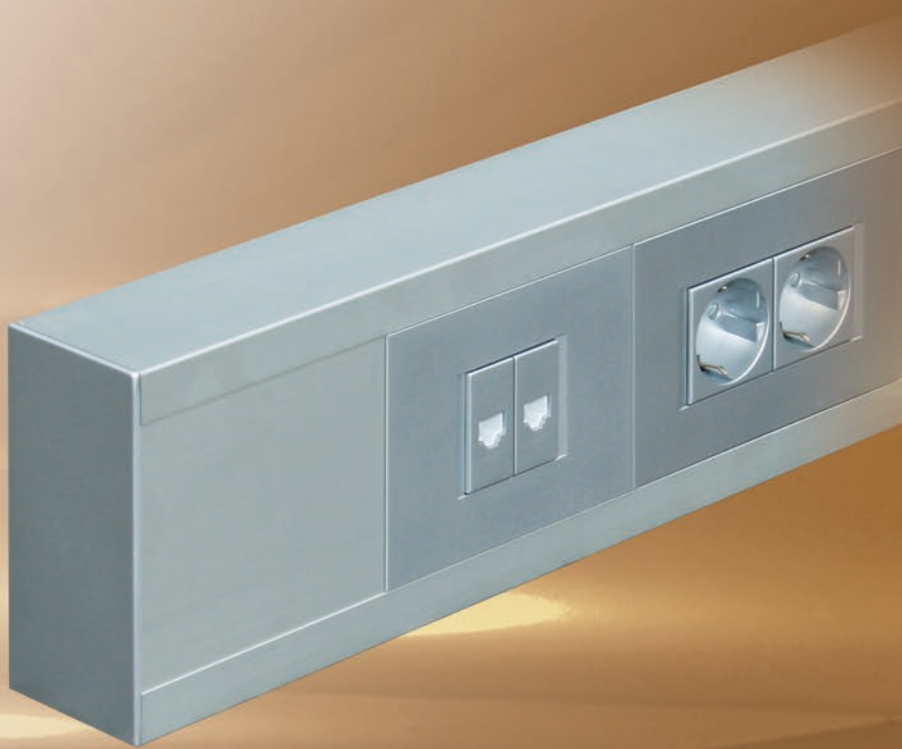



<p>KUĆIŠTA CUBO IP20 AC <i>BOXES CUBO IP20 AC</i></p>		148
<p>KUĆIŠTA CUBO IP55 AQ <i>BOXES CUBO IP55 AQ</i></p>		149
<p>PARAPETNI KANALI ALUMINIJ MA <i>TRUNKING SYSTEM ALUMINIUM MA</i></p>		150
<p>PODNE KUTIJE MT <i>FLOOR BOXES MT</i></p>		155
<p>RAZDJELNICI MO <i>DISTRIBUTION BOARDS MO</i></p>		158

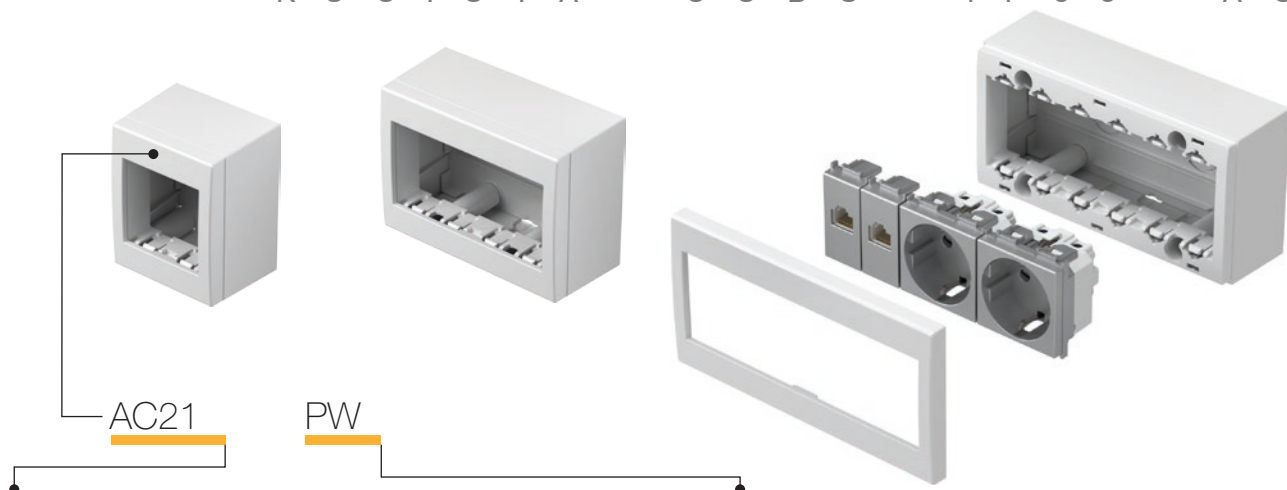

tip type	naziv description	tehnički podaci technical data	veličina size	boja colour
AC11	NADŽBUKNA KUTIJA SA STRAŽNJIM POKLOPCEM SURFACE MOUNT BOX WITH BACK SIDE COVER	IP20	1M	<input type="checkbox"/> PW bijela sjajna polar white
AC21	NADŽBUKNA KUTIJA SA STRAŽNJIM POKLOPCEM SURFACE MOUNT BOX WITH BACK SIDE COVER	IP20	2M	<input type="checkbox"/> ES srebrna mat elox silver
				<input type="checkbox"/> IW bež sjajna ivory white
AC41	NADŽBUKNA KUTIJA SA STRAŽNJIM POKLOPCEM SURFACE MOUNT BOX WITH BACK SIDE COVER	IP20	4M	

distribucija

KUTIJA NO CUBO SA STRAŽNJIM POKLOPCEM IP20 1M



- AC11PW
- AC11ES
- AC11IW

- kutija IP20 1M
- za nadžbukno pričvršćivanje elemenata
- prikladno za SM sklopke
- sukladno normi EN 60669-1

BOX NO CUBO WITH BACK SIDE COVER IP20 1M

- box IP20 1M
- for surface mounting of elements
- suitable to SM switches
- in accordance with EN 60669-1



KUTIJA NO CUBO SA STRAŽNJIM POKLOPCEM IP20 2M



- AC21PW
- AC21ES
- AC21IW

- kutija IP20 2M
- za nadžbukno pričvršćivanje elemenata
- sukladno normama EN 60669-1, EN60884-1

BOX NO CUBO WITH BACK SIDE COVER IP20 2M

- box IP20 2M
- for surface mounting of elements
- in accordance with EN 60669-1, EN60884-1



KUTIJA NO CUBO SA STRAŽNJIM POKLOPCEM IP20 4M



- AC41PW
- AC41ES
- AC41IW

- kutija IP20 4M
- za nadžbukno pričvršćivanje elemenata
- sukladno normama EN 60669-1, EN60884-1

BOX NO CUBO WITH BACK SIDE COVER IP20 4M

- box IP20 4M
- for surface mounting of elements
- in accordance with EN 60669-1, EN60884-1



KUTIJA NO CUBO SA STRAŽNJIM POKLOPCEM IP20 6M



- AC61PW
- AC61ES
- AC61IW

- kutija IP20 6M
- za nadžbukno pričvršćivanje elemenata
- sukladno normama EN 60669-1, EN60884-1

BOX NO CUBO WITH BACK SIDE COVER IP20 6M

- box IP20 6M
- for surface mounting of elements
- in accordance with EN 60669-1, EN60884-1

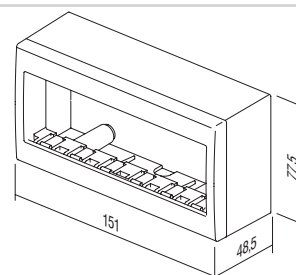
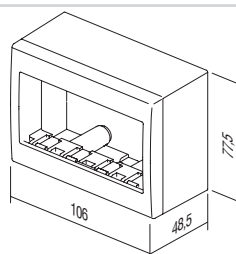
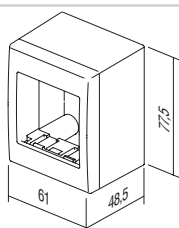
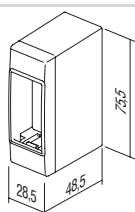

B O X E S C U B O I P 5 5 A Q

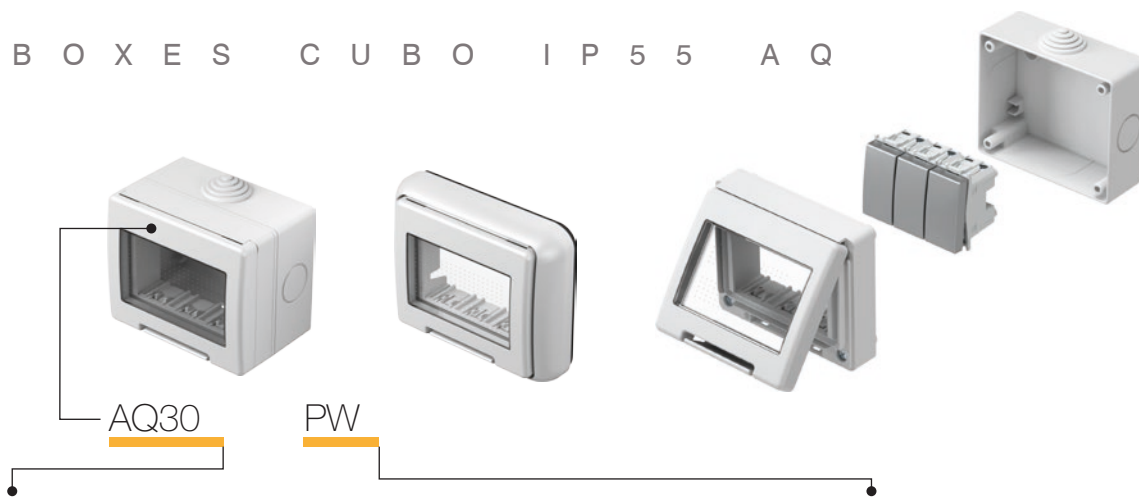

tip type	naziv description	tehnički podaci technical data	veličina size	boja colour
AQ20	VANJSKA NADŽBUKNA KUTIJA OUTDOOR SURFACE MOUNT BOX	IP55	2M	<input type="checkbox"/> PW bijela sjajna polar white
AQ22	VANJSKA NADŽBUKNA KUTIJA OUTDOOR SURFACE MOUNT BOX	IP55	2x2M	<input checked="" type="checkbox"/> GY siva grey
AQ30	VANJSKA NADŽBUKNA KUTIJA OUTDOOR SURFACE MOUNT BOX	IP55	3M	
AQ31	VANJSKA NADŽBUKNA KUTIJA OUTDOOR SURFACE MOUNT BOX	IP55	3M	

KUTIJA NO CUBO IP55 2M



- AQ20PW
 AQ20GY

- kutija IP55 2M
- za nadžbukno pričvršćivanje
- IP55 za ugradnju u vlažnom prostoru
- sukladno normama CEI 23-48, EN 60670

BOX NO CUBO IP55 2M

- box IP55 2M
- for surface mounting
- IP55 for usage in humid areas
- in accordance with CEI 23-48, EN 60670



KUTIJA NO CUBO IP55 2x2M



- AQ22PW
 AQ22GY

- kutija IP55 2x2M
- za nadžbukno pričvršćivanje
- IP55 za ugradnju u vlažnom prostoru
sukladno normama CEI 23-48, EN 60670

BOX NO CUBO IP55 2x2M

- box IP55 2x2M
- for surface mounting
- IP55 for usage in humid areas
- in accordance with CEI 23-48, EN 60670



KUTIJA NO CUBO IP55 3M



- AQ30PW
 AQ30GY

- kutija IP55 3M
- za nadžbukno pričvršćivanje
- IP55 za ugradnju u vlažnom prostoru
sukladno normama CEI 23-48, EN 60670

BOX NO CUBO IP55 3M

- box IP55 3M
- for surface mounting
- IP55 for usage in humid areas
- in accordance with CEI 23-48, EN 60670



KUTIJA PO CUBO IP55 3M



- AQ31PW
 AQ31GY

- kutija IP55 3M
- za podžbukno pričvršćivanje
- IP55 za ugradnju u vlažnom prostoru
- sukladno normama CEI 23-48, EN 60670

BOX PO CUBO IP55 3M

- box IP55 3M
- for flush mounting
- IP55 for usage in humid areas
- in accordance with CEI 23-48, EN 60670

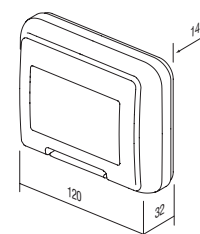
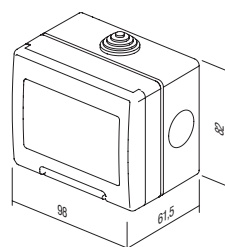
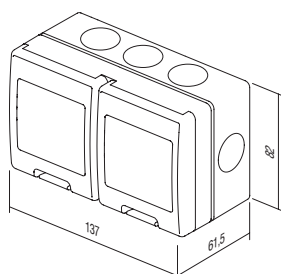
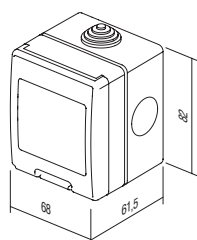

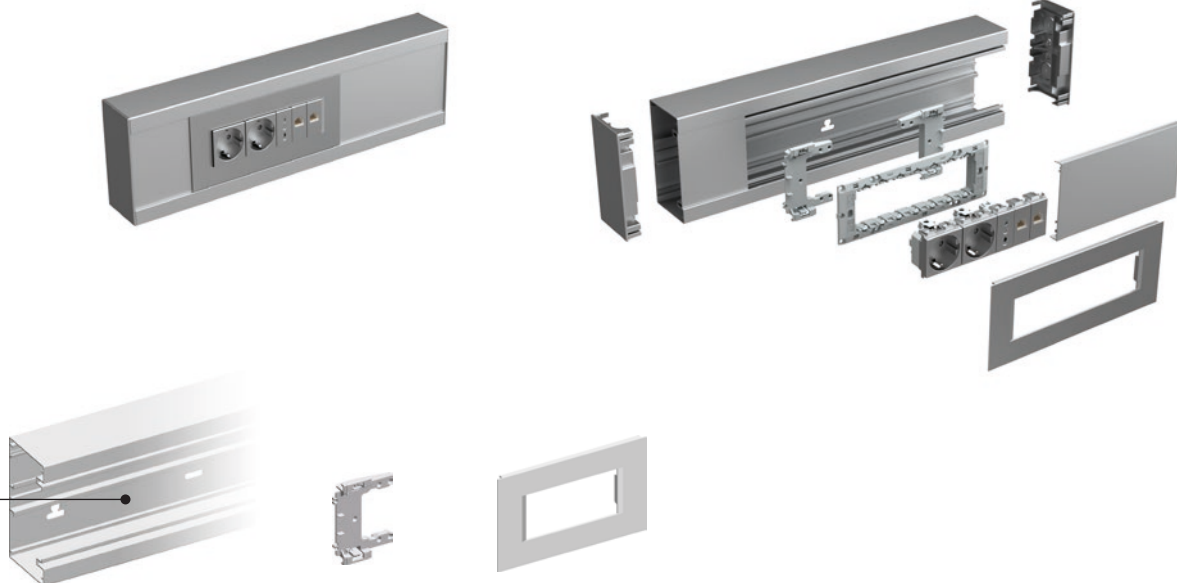

RT20

ES

tip type	naziv description	veličina size	boja colour
RT10	ADAPTER MA 92 ADAPTER MA 92	/	■ ES srebrna mat elox silver-mat
RT12	POKLOPAC MA 92 COVER PLATE MA 92	2/3M	□ PW bijela mat (RAL 9016) white-mat
RT14	POKLOPAC MA 92 COVER PLATE MA 92	4M	
⋮	⋮	⋮	

ADAPTER MA 92



RT10

- adapter za pričvršćivanje nosača 2/3M, 4M ili 7M na kanal MA bez kutije
- za svaki su nosač potrebna dva adaptera
- sukladno normi EN 50085-1

ADAPTER MA 92

- adapter for fixing mounting frames 2/3M, 4M or 7M on MA trunking without box
- each mounting frame needs two adapters
- in accordance with EN 50085-1

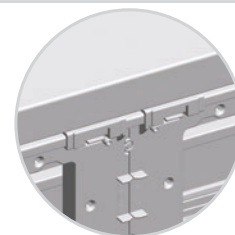

POKLOPAC MA 92 2/3M



■ RT12ES
□ RT12PW

- dekorativni poklopac MA 2/3M
- sukladno normi EN 50085-1

COVER PLATE MA 92 2/3M

- decorative cover plate MA 2/3M
- in accordance with EN 50085-1

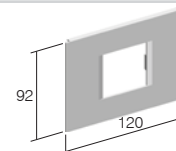

POKLOPAC MA 92 4M



■ RT14ES
□ RT14PW

- dekorativni poklopac MA 4M
- sukladno normi EN 50085-1

COVER PLATE MA 92 4M

- decorative cover plate MA 4M
- in accordance with EN 50085-1

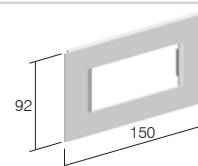

POKLOPAC MA 92 7M

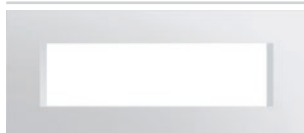

■ RT17ES
□ RT17PW

- dekorativni poklopac MA 7M
- sukladno normi EN 50085-1

COVER PLATE MA 92 7M

- decorative cover plate MA 7M
- in accordance with EN 50085-1

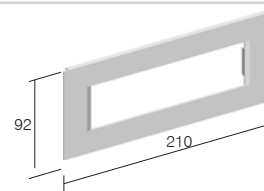

OSNOVA KANALA MA 130x65

■ RT20ES
□ RT20PW

- osnova kanala od ekstrudiranog aluminija
- visina 130 mm, duljina 2 m
- DIN tračnica 35 mm na dnu
- sukladno normi EN 50085-1

TRUNKING BASE MA 130x65

- trunking base from extruded aluminium
- height 130mm, length 2m
- DIN - rail 35mm shape on bottom
- in accordance with EN 50085-1

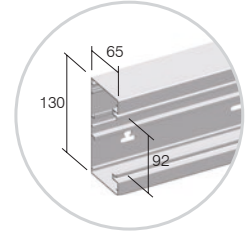
**OSNOVA KANALA MA 165x65**

■ RT21ES
□ RT21PW

- osnova kanala od ekstrudiranog aluminija
- visina 165mm, duljina 2 m
- DIN tračnica 35 mm na dnu
- sukladno normi EN 50085-1

TRUNKING BASE MA 165x65

- trunking base from extruded aluminium
- height 165mm, length 2m
- DIN - rail 35mm shape on bottom
- in accordance with EN 50085-1

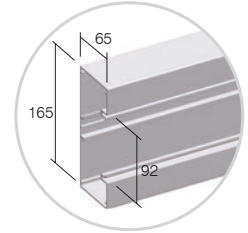
**POKLOPAC KANALA MA 92**

■ RT25ES
□ RT25PW

- poklopac kanala od ekstrudiranog aluminija
- visina 92mm, duljina 2 m
- sukladno normi EN 50085-1

FRONT COVER MA 92

- front cover from extruded aluminium
- height 92mm, length 2m
- in accordance with EN 50085-1

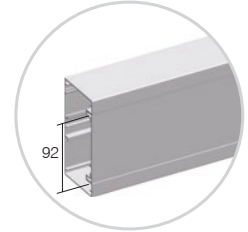
**PREGRADA MA 43**

RT30

- pregrada od ekstrudiranog polimera
- dubina 43 mm, duljina 2 m
- sukladno normi EN 50085-1

CABLE SHELF MA 43

- cable shelf from extruded polymer
- depth 43mm, length 2m
- in accordance with EN 50085-1

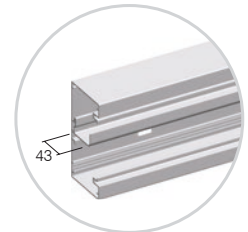
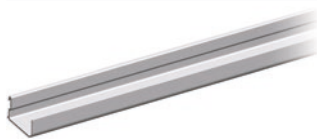
**PREGRADA MA 43 AL**

RT31

- pregrada od ekstrudiranog aluminija
- dubina 43 mm, duljina 2 m
- sukladno normi EN 50085-1

CABLE SHELF MA 43 AL

- cable shelf from extruded aluminium
- depth 43mm, length 2m
- in accordance with EN 50085-1

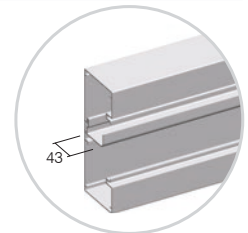
**PREGRADA MA 43 AL DVOSTRUKA**

RT32

- dvostruka pregrada od ekstrudiranog aluminija
- dubina 43 mm, duljina 2 m
- sukladno normi EN 50085-1

CABLE SHELF MA 43 AL DOUBLE

- double cable shelf from extruded aluminium
- depth 43mm, length 2m
- in accordance with EN 50085-1

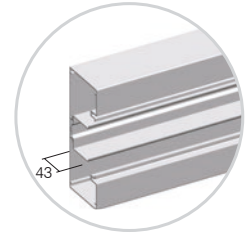



- RT35ES
- RT35PW

ZAVRŠNI ELEMENT MA 130x65

- završni element od polimera
- visina 130mm
- sukladno normi EN 50085-1

STOP END MA 130x65

- stop end element from polymer
- height 130mm
- in accordance with EN 50085-1

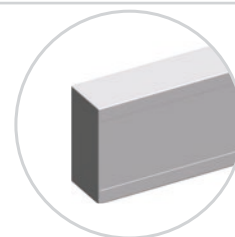

- RT36ES
- RT36PW

ZAVRŠNI ELEMENT MA 165x65

- završni element od metala
- visina 165mm
- sukladno normi EN 50085-1

STOP END MA 165x65

- stop end element from metal
- height 165mm
- in accordance with EN 50085-1

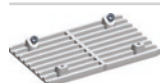
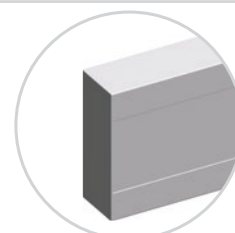

RT38

SET SPOJNI ELEMENT MA 65

- spojni element od polimera
- set sadrži 2 spojna elementa i vijke
- sukladno normi EN 50085-1

SET JOINING PIECE MA 65

- joining piece from polymer
- set contains two pieces and screws
- in accordance with EN 50085-1

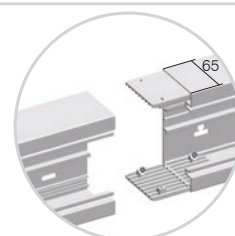

- RT40ES
- RT40PW

UNIVERZALNI KUT MA 130x65

- univerzalni kutni element
- visina 130mm
- sukladno normi EN 50085-1

UNIVERSAL CORNER MA 130x65

- universal corner element
- height 130mm
- in accordance with EN 50085-1

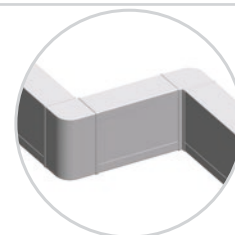

- RT41ES
- RT41PW

UNIVERZALNI KUT MA 165x65

- univerzalni kutni element
- visina 165mm
- sukladno normi EN 50085-1

UNIVERSAL CORNER MA 165x65

- universal corner element
- height 165mm
- in accordance with EN 50085-1

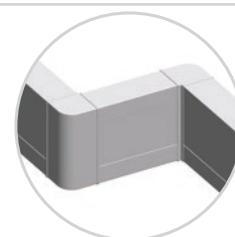

RT42

ELEMENT ZA UZEMLJENJE MA 2x A6.3

- element za uzemljenje osnove kanala i poklopca
- sukladno normi EN 50085-1

EARTHING PIECE MA 2x A6.3

- earthing piece for earthing of trunking base and front cover
- in accordance with EN 50085-1

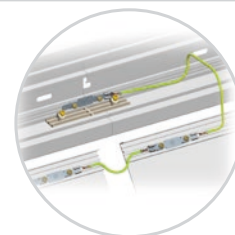

T R U N K I N G S Y S T E M A L U M I N I U M

L-KOMAD ELEMENT MA 130x65

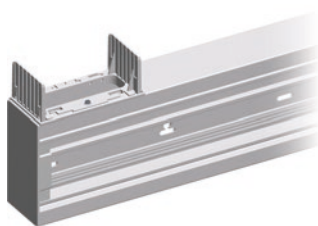

- RT43ES
- RT43PW

- univerzalni L-komad od aluminija
- visina 130 mm, dužina 400mm
- sukladno normi EN 50085-1

L-BEND MA 130x65

- universal L bend element from aluminium
- height 130mm, length 400mm
- in accordance with EN 50085-1

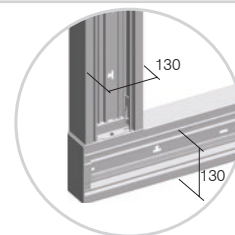

L-KOMAD ELEMENT MA 165x65

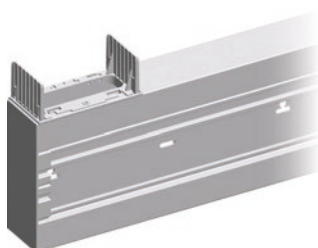

- RT44ES
- RT44PW

- univerzalni L-komad od aluminija
- visina 165mm, dužina 400mm
- za povezivanje na MA 130x65
- sukladno normi EN 50085-1

L-BEND MA 165x65

- universal L bend element from aluminium
- height 165mm, length 400mm
- connection on MA 130x65
- in accordance with EN 50085-1

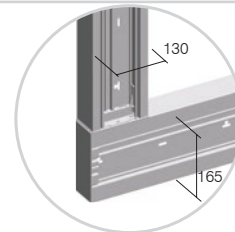

T-KOMAD MA 130x65

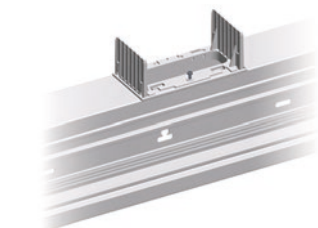

- RT45ES
- RT45PW

- univerzalni T-komad od aluminija
- visina 130 mm, dužina 400mm
- sukladno normi EN 50085-1

T-BEND MA 130x65

- universal T bend element from aluminium
- height 130mm, length 400mm
- in accordance with EN 50085-1

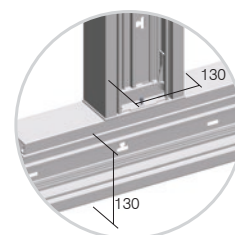

T-KOMAD MA 165x65

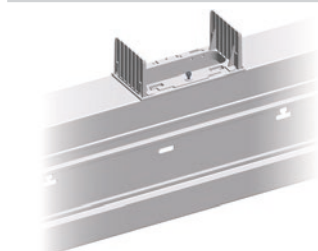

- RT46ES
- RT46PW

- univerzalni T-komad od aluminija
- visina 165mm, dužina 400mm
- za povezivanje na MA 130x65
- sukladno normi EN 50085-1

T-BEND MA 165x65

- universal T bend element from aluminium
- height 165mm, length 400mm
- connection on MA 130x65
- in accordance with EN 50085-1

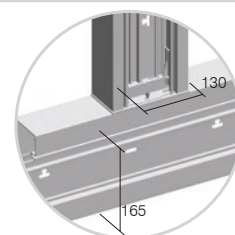

MA parapetni kanali temelje se na modularnom sustavu s kombinacijama elemenata veličine 2M, 4M ili 7M

MA trunking is based on modular system making 2M, 4M or 7M combinations of elements

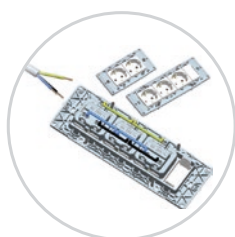

Modul sadrži posebne elemente pripremljene za brzu instalaciju

In Modul we provide special elements for quick installation

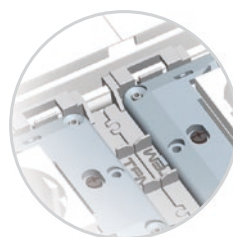

Adapter MA omogućuje točno postavljanje bez dodatnog napora

With Adapter MA exact positioning without extra effort is provided

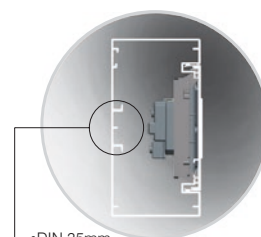

Montaža bez kutije znači više prostora za kablove, DIN tračnica ima oblik sukladan normi EN 60715

Mounted without box means more space for cables, DIN-rail base shape EN-60715

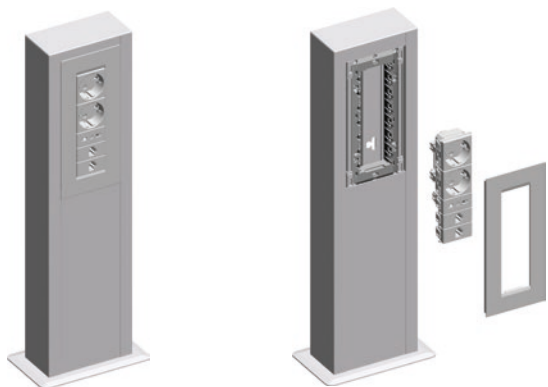

NOSAČ STUPIČA MA JEDNOSTRUKI 130x65



- RT50ES
- RT50PW

- nosač za pričvršćivanje kanala MA130 na podu i/ili na stropu
- sukladno normi EN 50085-1

FIXING PLATE MA SINGLE 130x65

- fixing plate for fixing trunking base MA130 on the floor and/or on the ceiling
- in accordance with EN 50085-1

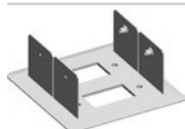

- RT51ES
- RT51PW

NOSAČ STUPIČA MA DVOSTRUKI 130x65

- nosač za pričvršćivanje dva kanala MA130 na podu i/ili na stropu
- sukladno normi EN 50085-1

FIXING PLATE MA DOUBLE 130x65

- fixing plate for fixing two trunking bases MA130 on the floor and/or on the ceiling
- in accordance with EN 50085-1

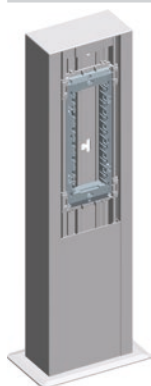
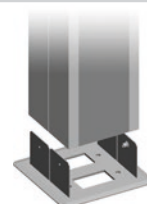

- RT52ES
- RT52PW

STUPIČ MA 130x65x500

- stupić MA
- visina 500mm
- nosač 7M ugrađen
- sukladno normi EN 50085-1

SERVICE POST MA 130x65x500

- service post MA
- height 500mm
- mounting frame 7M included
- in accordance with EN 50085-1



- RT53ES
- RT53PW

STUPIČ MA DVOSTRUKI 130x130x500

- stupić MA dvostruki
- visina 500mm
- nosači 7M ugrađeni
- sukladno normi EN 50085-1

SERVICE POST MA DOUBLE 130x130x500

- service post MA double
- height 500mm
- mounting frames 7M included
- in accordance with EN 50085-1

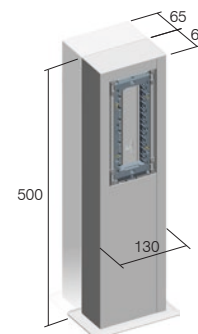

Cable intersection mm ²	Poprečni presjek vodiča / Cable cross-section (mm ²)				
	1 vodič / 1 wire	2 vodiča / 2 wires	3 vodiča / 3 wires	4 vodiča / 4 wires	5 vodiča / 5 wires
1,5	44	111	121	144	169
2,5	49	133	157	169	211
4	58	169	183	211	256
6	68	196	225	256	307

Kapacitet parapetnog kanala / Trunk capacity				
Kanal / Trunk	MA 130x65 prazan / empty	MA 130x65 s Modul sklopkama i utičnicama / with Modul switches and sockets	MA 165x65 prazan / empty	MA 130x65 s Modul sklopkama i utičnicama / with Modul switches and sockets
kapaciteta capacity max ø	7600 mm ² 54 mm	5500 mm ² 2x42 mm	9900 mm ² 54 mm	7800 mm ² 2x42 mm

F L O O R B O X E S M T

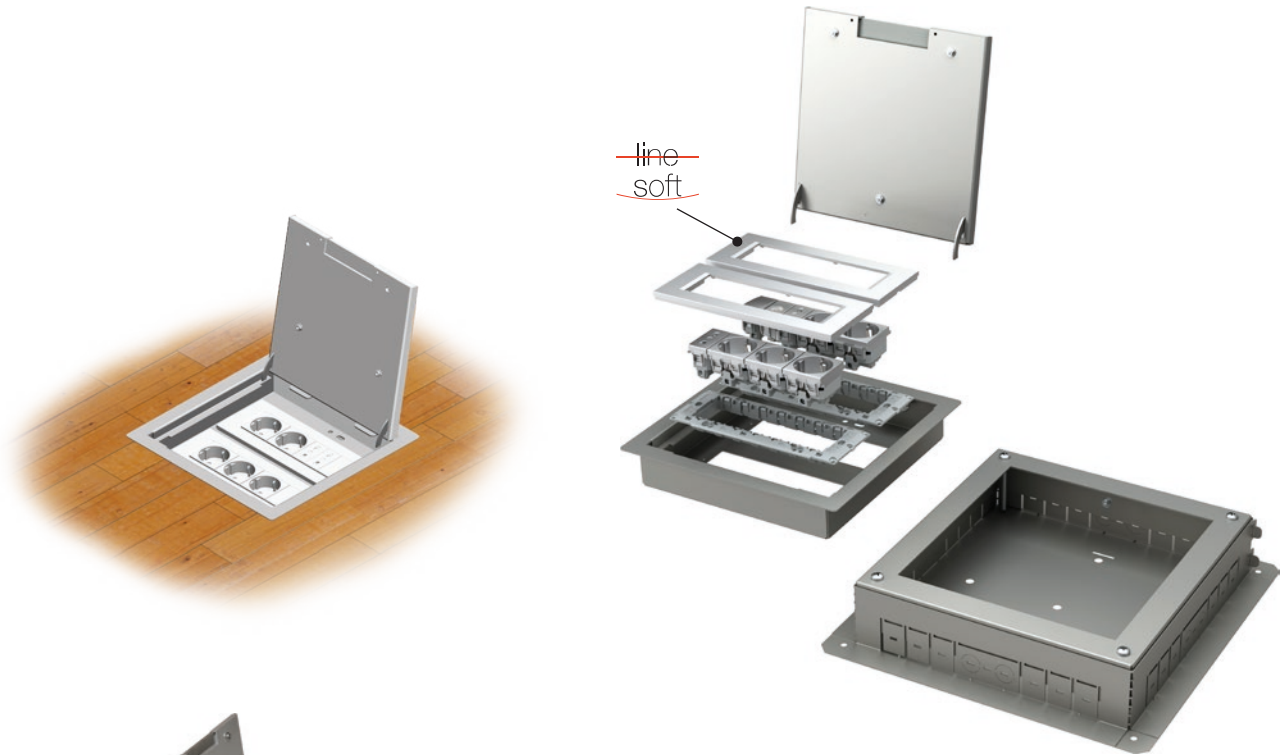

RB33

tip type	naziv description	tehnički podaci technical data
RB30	PODNA KUTIJA FLOOR BOX	MT 7
RB31	SPOJNA PRIRUBNICA PODNE KUTIJE MT 7 FLOOR BOX FLANGE	
RB33	PODNA KUTIJA FLOOR BOX	MT 14
...

	RB30	RB33	RB36	RB40	RB43	RB46
a	170	260	350	170	260	350
b	260	260	260	260	260	260
X	140	230	320	140	230	320
Y	230	230	230	230	230	230

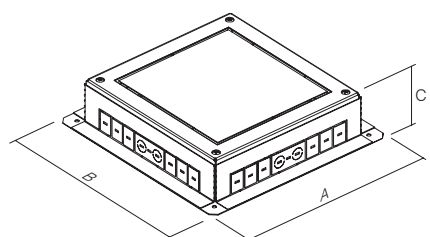
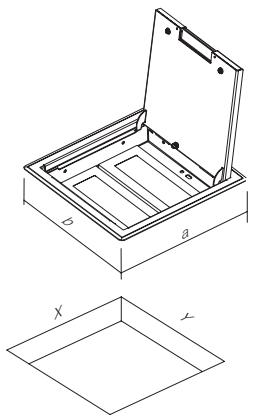

	RB31	RB34	RB37	RB41	RB44	RB47
A	270	360	450	270	360	450
B	360	360	360	360	360	360
C	95-125	95-125	95-125	120-150	120-150	120-150

PODNA KUTIJA MT 7



RB30

- podna kutija MT 7
- metalna, srebrne boje RAL 9006
- nosač MODUL 7M ugrađen
- ugradne dimenzije 140x230 mm, dubina min. 95 mm
- debljina podne obloge poklopca do 10 mm
- sukladno normama EN 50085-1 i EN 50085-2-2

FLOOR BOX MT 7

- floor box MT 7
- metal, colour silver RAL 9006
- mounting frame MODUL 7M included
- mounting dimensions 140x230mm, depth min 95mm
- floor lining thickness up to 10mm
- in accordance with EN 50085-1 and EN 50085-2-2

PODNA KUTIJA MT 7 H = 88mm



RB40

- podna kutija MT 7
- metalna, srebrne boje RAL 9006
- nosač MODUL 7M ugrađen
- ugradne dimenzije 140x230 mm, dubina min. 120mm
- debljina podne obloge poklopca do 10 mm
- sukladno normama EN 50085-1 i EN 50085-2-2

FLOOR BOX MT 7 H=88mm

- floor box MT 7
- metal, colour silver RAL 9006
- mounting frame MODUL 7M included
- mounting dimensions 140x230mm, depth min 120mm
- floor lining thickness up to 10mm
- in accordance with EN 50085-1 and EN 50085-2-2

SPOJNA PRIRUBNICA PODNE KUTIJE MT 7

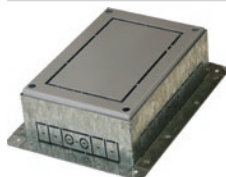

RB31

- spojna prirubnica podne kutije za poklopac MT 7
- metalna, galvanizirana
- za ugradnju u pod ili dvostruki pod
- prilagodljiva visina 95-125 mm
- sukladno normama EN 50085-1 i EN 50085-2-2

FLOOR BOX FLANGE MT 7

- floor box flange for box cover MT 7
- metal, galvanized
- for installation in a floor or double floor
- adjustable height 95-125mm
- in accordance with EN 50085-1 and EN 50085-2-2

SPOJNA PRIRUBNICA PODNE KUTIJE MT 7 H = 88mm



RB41

- spojna prirubnica podne kutije za poklopac MT 7 H = 88 mm
- metalna, galvanizirana
- za ugradnju u pod ili dvostruki pod
- prilagodljiva visina 120-150mm
- sukladno normama EN 50085-1 i EN 50085-2-2

FLOOR BOX FLANGE MT 7 H=88mm

- floor box flange for box cover MT 7 H=88mm
- metal, galvanized
- for installation in a floor or double floor
- adjustable height 120-150mm
- in accordance with EN 50085-1 and EN 50085-2-2

SPOJNA PRIRUBNICA PODNE KUTIJE MT 14



RB33

- podna kutija MT 14
- metalna, srebrne boje RAL 9006
- nosači MODUL 2x7M ugrađeni
- ugradne dimenzije 230x230 mm, dubina min. 95 mm
- debljina podne obloge poklopca do 10 mm
- sukladno normama EN 50085-1 i EN 50085-2-2

FLOOR BOX MT 14

- floor box MT 14
- metal, colour silver RAL 9006
- mounting frames MODUL 7M included
- mounting dimensions 140x230mm, depth min 95mm
- floor lining thickness up to 10mm
- in accordance with EN 50085-1 and EN 50085-2-2

PODNA KUTIJA MT 14 H = 88mm



RB43

- podna kutija MT 14
- metalna, srebrne boje RAL 9006
- nosači MODUL 2x7M ugrađeni
- ugradne dimenzije 230x230 mm, dubina min. 120mm
- debljina podne obloge poklopca do 10 mm
- sukladno normama EN 50085-1 i EN 50085-2-2

FLOOR BOX MT 14 H=88mm

- floor box MT 14
- metal, colour silver RAL 9006
- mounting frames MODUL 2x7M included
- mounting dimensions 230x230mm, depth min 120mm
- floor lining thickness up to 10mm
- in accordance with EN 50085-1 and EN 50085-2-2

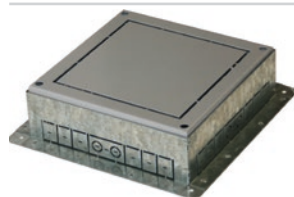
SPOJNA PRIRUBNICA PODNE KUTIJE MT 14

RB34

- spojna prirubnica podne kutije za poklopac MT 14
- metalna, galvanizirana
- za ugradnju u pod ili dvostruki pod
- prilagodljiva visina 95-125 mm
- sukladno normama EN 50085-1 i EN 50085-2-2

FLOOR BOX FLANGE MT 14

- floor box flange for box cover MT 14
- metal, galvanized
- for installation in a floor or double floor
- adjustable height 95-125mm
- in accordance with EN 50085-1 and EN 50085-2-2

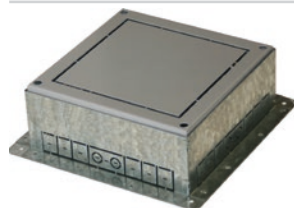
SPOJNA PRIRUBNICA PODNE KUTIJE MT 14 H = 88mm

RB44

- spojna prirubnica podne kutije za poklopac MT 14 H = 88 mm
- metalna, galvanizirana
- za ugradnju u pod ili dvostruki pod
- prilagodljiva visina 120-150mm
- sukladno normama EN 50085-1 i EN 50085-2-2

FLOOR BOX FLANGE MT 14 H=88mm

- floor box flange for box cover MT 14 H=88mm
- metal, galvanized
- for installation in a floor or double floor
- adjustable height 120-150mm
- in accordance with EN 50085-1 and EN 50085-2-2

PODNA KUTIJA MT 21

RB36

- podna kutija MT 21
- metalna, srebrne boje RAL 9006
- nosači MODUL 3x7M ugrađeni
- ugradne dimenzije 320x230 mm, dubina min. 95 mm
- debljina podne obloge poklopca do 10 mm
- sukladno normama EN 50085-1 i EN 50085-2-2

FLOOR BOX MT 21

- floor box MT 21
- metal, colour silver RAL 9006
- mounting frames MODUL 3x7M included
- mounting dimensions 320x230mm, depth min 95mm
- floor lining thickness up to 10mm
- in accordance with EN 50085-1 and EN 50085-2-2

PODNA KUTIJA MT 21 H = 88mm

RB46

- podna kutija MT 21
- metalna, srebrne boje RAL 9006
- nosači MODUL 3x7M ugrađeni
- ugradne dimenzije 320x230 mm, dubina min. 120mm
- debljina podne obloge poklopca do 10 mm
- sukladno normama EN 50085-1 i EN 50085-2-2

FLOOR BOX MT 21 H=88mm

- floor box MT 21
- metal, colour silver RAL 9006
- mounting frames MODUL 3x7M included
- mounting dimensions 320x230mm, depth min 120mm
- floor lining thickness up to 10mm
- in accordance with EN 50085-1 and EN 50085-2-2

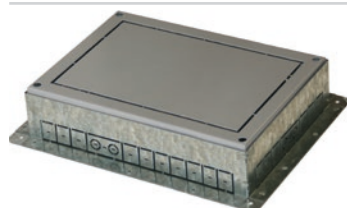
SPOJNA PRIRUBNICA PODNE KUTIJE MT 21

RB37

- spojna prirubnica podne kutije za poklopac MT 21
- metalna, galvanizirana
- za ugradnju u pod ili dvostruki pod
- prilagodljiva visina 95-125 mm
- sukladno normama EN 50085-1 i EN 50085-2-2

FLOOR BOX FLANGE MT 21

- floor box flange for box cover MT 21
- metal, galvanized
- for installation in a floor or double floor
- adjustable height 95-125mm
- in accordance with EN 50085-1 and EN 50085-2-2

SPOJNA PRIRUBNICA PODNE KUTIJE MT 21 H = 88mm

RB47

- spojna prirubnica podne kutije za poklopac MT 21 H = 88 mm
- metalna, galvanizirana
- za ugradnju u pod ili dvostruki pod
- prilagodljiva visina 120-150mm
- sukladno normama EN 50085-1 i EN 50085-2-2

FLOOR BOX FLANGE MT 21 H=88mm

- floor box flange for box cover MT 21 H=88mm
- metal, galvanized
- for installation in a floor or double floor
- adjustable height 120-150mm
- in accordance with EN 50085-1 and EN 50085-2-2

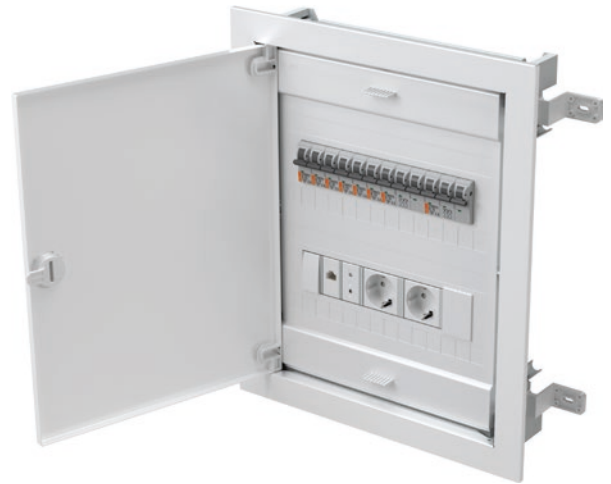
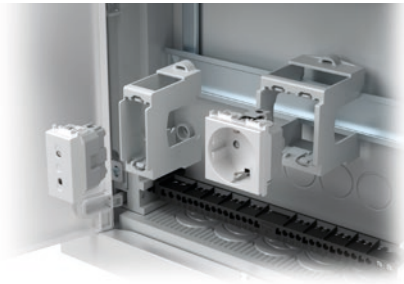

RB20

tip type	naziv description	tehnički podaci technical data
RB10	ADAPTER ZA DIN TRAČNICU ADAPTER FOR DIN RAIL	35mm 1M
RB11	ADAPTER ZA DIN TRAČNICU ADAPTER FOR DIN RAIL	35mm 2M
RB20	RAZDJELNI ORMARIĆ DISTRIBUTION BOX	MO 12+2
⋮	⋮	⋮

ADAPTER ZA DIN TRAČNICU 35mm 1M



RB10

- adapter MODUL 1M
- za Din tračnicu 35 mm
- sukladno normi EN 50022

ADAPTER FOR DIN RAIL 35mm 1M

- adapter MODUL 1M
- for DIN rail 35mm
- in accordance with EN 50022

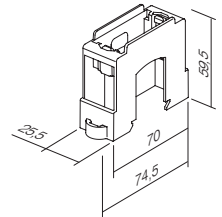

ADAPTER ZA DIN TRAČNICU 35mm 2M



RB11

- adapter MODUL 2M
- za Din tračnicu 35 mm
- sukladno normi EN 50022

ADAPTER FOR DIN RAIL 35mm 2M

- adapter MODUL 2M
- for DIN rail 35mm
- in accordance with EN 50022

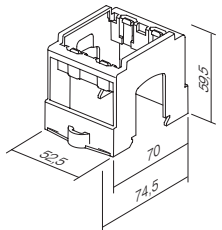

D I S T R I B U T I O N B O A R D S M O

RAZDJELNI ORMARIĆ MO 12 + 2



RB20

- razdjelni ormarić MO jedan red 12+2MU
- 400V ~, razred II, IP40
- metalna vratašca i okvir, bijele boje RAL 9016
- priloženi konektori za vod za uzemljenje i neutralni vod
- univerzalna ugradnja u zid od opeke ili u šuplji zid
- sukladno normama EN 60670-1 i IEC 60670-24

DISTRIBUTION BOX MO 12+2

- *distribution box MO single row 12+2MU*
- *400V~, Class II, IP40*
- *metal leveling frame and door, colour white RAL 9016*
- *neutral and earth conductor terminals enclosed*
- *universal for brick or hollow wall mounting*
- *in accordance with EN 60670-1 and IEC 60670-24*

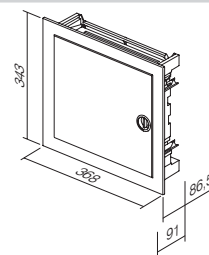

RAZDJELNI ORMARIĆ MO 24 + 4



RB21

- razdjelni ormarić MO dva reda 24+4MU
- 400V ~, razred II, IP40
- metalna vratašca i okvir, bijele boje RAL 9016
- priloženi konektori za vod za uzemljenje i neutralni vod
- univerzalna ugradnja u zid od opeke ili u šuplji zid
- sukladno normama EN 60670-1 i IEC 60670-24

DISTRIBUTION BOX MO 24+4

- *distribution box MO double row 24+4MU*
- *400V~, Class II, IP40*
- *metal leveling frame and door, colour white RAL 9016*
- *neutral and earth conductor terminals enclosed*
- *universal for brick or hollow wall mounting*
- *in accordance with EN 60670-1 and IEC 60670-24*

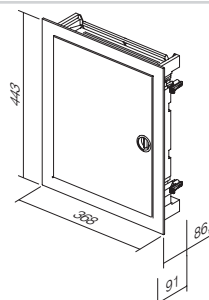

RAZDJELNI ORMARIĆ MO 36 + 6



RB22

- razdjelni ormarić MO tri reda 36+4MU
- 400V ~, razred II, IP40
- metalna vratašca i okvir, bijele boje RAL 9016
- priloženi konektori za vod za uzemljenje i neutralni vod
- univerzalna ugradnja u zid od opeke ili u šuplji zid
- sukladno normama EN 60670-1 i IEC 60670-24

DISTRIBUTION BOX MO 36+6

- *distribution box MO triple row 36+6 MU*
- *400V~, Class II, IP40*
- *metal leveling frame and door, colour white RAL 9016*
- *neutral and earth conductor terminals enclosed*
- *universal for brick or hollow wall mounting*
- *in accordance with EN 60670-1 and IEC 60670-24*

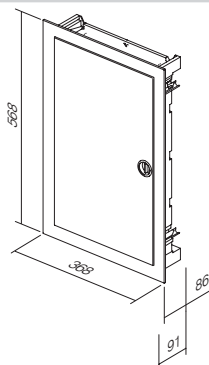

RAZDJELNI ORMARIĆ MO 48 + 8



RB23

- razdjelni ormarić MO četiri reda 48+4MU
- 400V ~, razred II, IP40
- metalna vratašca i okvir, bijele boje RAL 9016
- priloženi konektori za vod za uzemljenje i neutralni vod
- univerzalna ugradnja u zid od opeke ili u šuplji zid
- sukladno normama EN 60670-1 i IEC 60670-24

DISTRIBUTION BOX MO 48+8

- *distribution box MO quad row 48+8 MU*
- *400V~, Class II, IP40*
- *metal leveling frame and door, colour white RAL 9016*
- *neutral and earth conductor terminals enclosed*
- *universal for brick or hollow wall mounting*
- *in accordance with EN 60670-1 and IEC 60670-24*

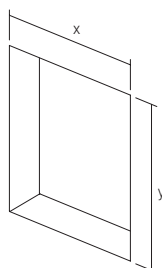
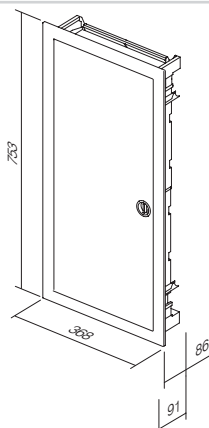

	RB20	RB21	RB22	RB23
x	314	314	314	314
y	314	414	539	724



ekonomik[®]



Planned for excellence
Style is essential



ERGO

METAL

SOFT

Neutralan, kompaktan, elegantan dizajn može se prilagoditi svakom okruženju u kojem boravite ili radite. Ne odstupa od interijera, nego se u njega harmonično uklapa.

A neutral, compact, elegant design is adjustable to every working or living area. It does not stick out from the interior, but rather harmonically fits into it.





Planirano za savršenstvo Stil je bitan



Čista linija nježno je zaobljena – dobro osmišljena ergonomija posebno za vas.

A pure line is slightly curved - well considered ergonomics especially for you.



Možete birati između sjajnih reflektirajućih površina i suvremenoga metalnog izgleda.

You can choose between shiny reflective surfaces and modern metallic look.



Mekoća oblika pronaći će svoje mjesto, kako u modernim interijerima tako i u onim klasičnim.

The softness of the form will find its place in modern as well as in classic interiors.

HARMONY

REFLEX

UV PROTECT

Želje mogu biti vrlo različite. Stoga smo za vas pomno odabrali mogućnosti koje vam pružaju pravi odgovor. Neutralna paleta boja dodatno će ispuniti vaš ambijent – neće vas ograničavati.

Press and the world will spring to life
Colourful landscape between walls

Desires can be very different. Therefore we have carefully selected possibilities for you, which can offer you the right answer. A neutral palette of colours will only complement your ambient - it will not restrict it.



Doživljaj refleksije pružit će vam sjajni metalni od polimera u bijeloj i bež boji.

Shiny polymer materials in white and beige colours enable reflective mood.



Odabrani dekorativni metalni sloj istovremeno je i moderan i neutralan.

Selected decorative metallic coat is at the same time modern and neutral.

Pritisnite i svijet će oživjeti Šareni krajolik između zidova



Za sve vas, koji se želite igrati pastelnim bojama, Ekonomik Colour idealno je rješenje.

For those who want to play with pastel colours Ekonomik Color represents a perfect solution.



Robusnost i velika otpornost na vanjske utjecaje (UV) osigurane su duroplastičnim materijalom (linija Colour).

Robustness and high resistance to external effects (UV) are secured by duroplastic materials (Color line).

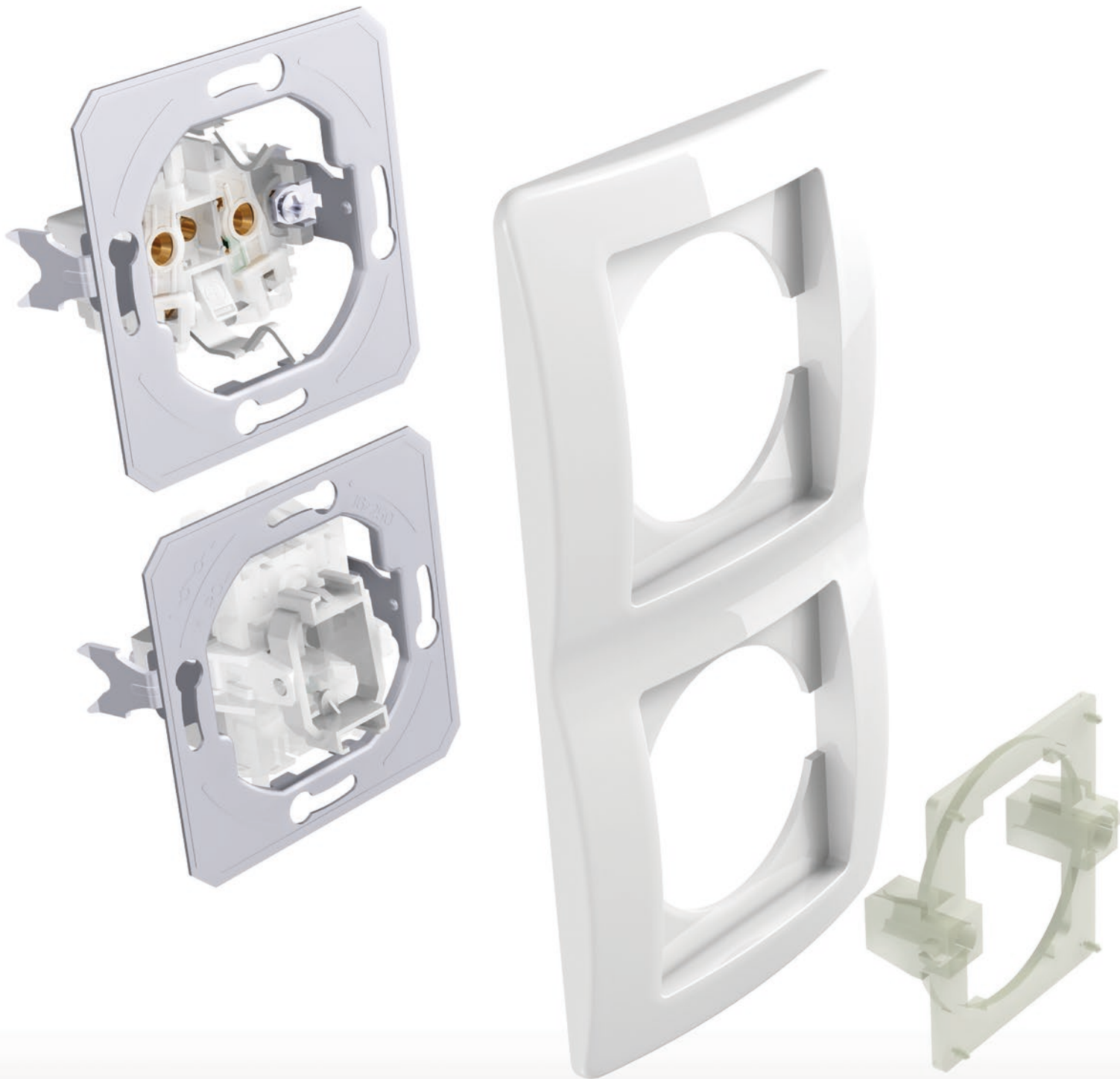

VERTICAL

HORIZONTAL

SAVE SPACE



Pri sastavljanju sačuvajte prostor na zidu. Ako raspoložete s malo prostora, prava je odluka „okomito“.

With combining you save space on the wall. When faced with a limited space, »vertically« is the right decision.



Kombinirajte prema vlastitoj želji.

Combine as you please.



Vidljivi elementi mogu se jednostavno demontirati. Bit će vam zahvalni i majstori.

Visible elements can be easily taken apart. Painters will be grateful to you.



Prolonge your day with a touch
Simplified living

Produžite svoj dan dodirom Za jednostavniji život

Ekonomik je rješenje za sustav standardnih okruglih kutija. Pomoću njega možemo planirati kako jednostavne instalacije, novogradnje i adaptacije tako i one zahtjevnije. Sustav karakterizira spajanje bez upotrebe vijaka što će vam uštedjeti vrijeme pri ugradnji elemenata.

Ekonomik is a solution for the system of standardized round installations boxes. It can be used for simple as well as more demanding installations, new buildings and adaptations. The system is characterised by plug-in contacts which save time during installation of elements.

Osjećajte se ugodno u sigurnom skloništu Potpuno povjerenje u dobru izgradnju

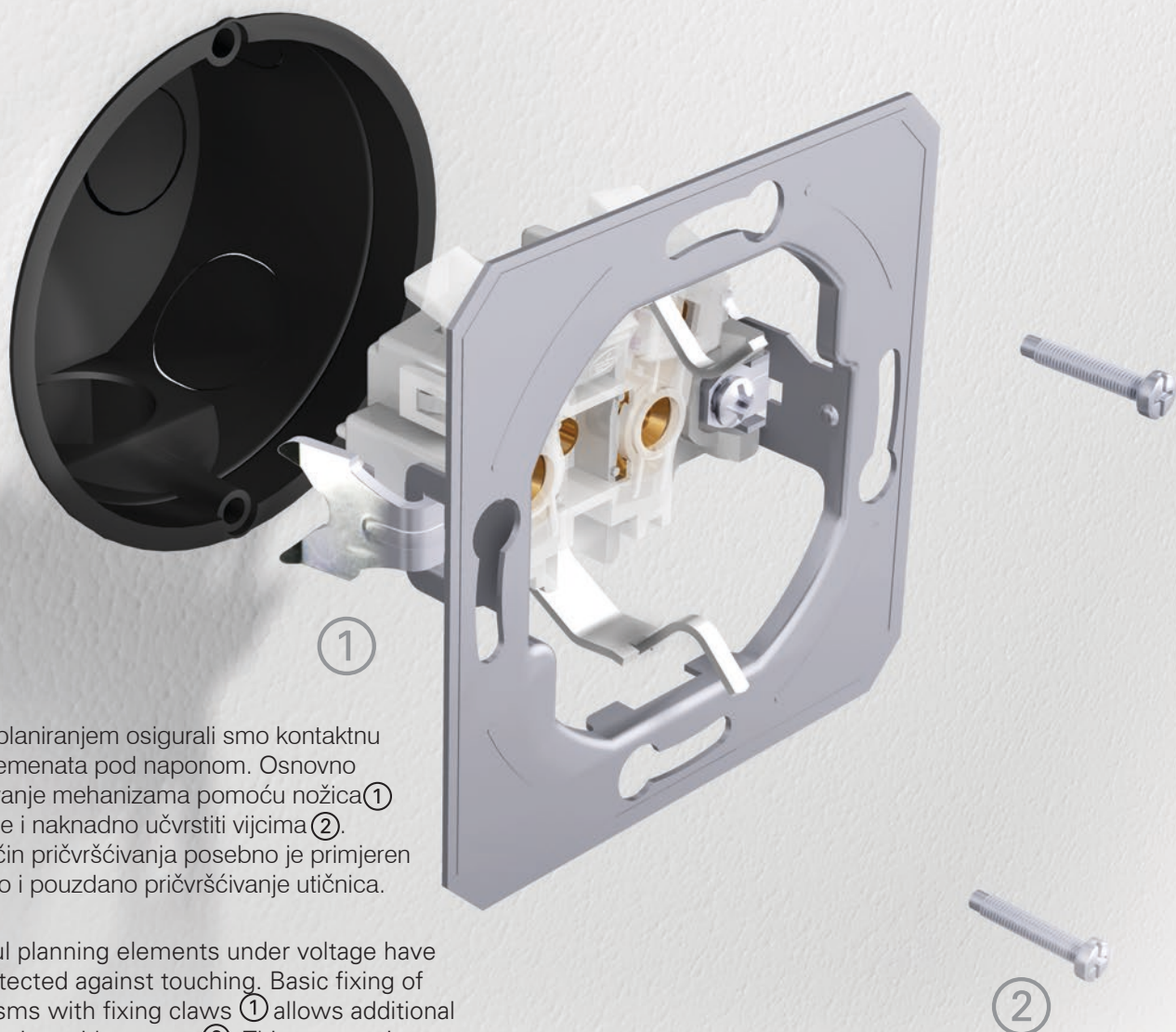

Pomnim planiranjem osigurali smo kontaktnu zaštitu elemenata pod naponom. Osnovno pričvršćivanje mehanizama pomoću nožica ① moguće je i naknadno učvrstiti vijcima ②. Takav način pričvršćivanja posebno je primjeren za sigurno i pouzdano pričvršćivanje utičnica.

By careful planning elements under voltage have been protected against touching. Basic fixing of mechanisms with fixing claws ① allows additional strengthening with screws ②. This manner is especially appropriate for safe and reliable fixing of sockets.

SIMPLE

FAST

FLEX



Dobro osmišljena konstrukcija sklopki omogućava također i jednostavno dodatno osvjetljenje.

A well-planned switch construction makes easy illumination possible also subsequently.



Spajanje bez vijaka omogućava brzo i pouzdano priključenje vodiča. Na isti se kontakt mogu pričvrstiti dva vodiča različitih presjeka.

Plug-in contacts enable quick and reliable attachment of wires. Two wires of different diameters can be attached to the same contact.

Montažne kutije olakšat će vam posao ugradnje. Zajamčene su odgovarajuće duljine.

Easy-fitting installation boxes will make your work easier. Proper lengths are guaranteed.



Feeling well in a safe shelter Total confidence in a good construction

SAFE

THRUST

CERTIFIED

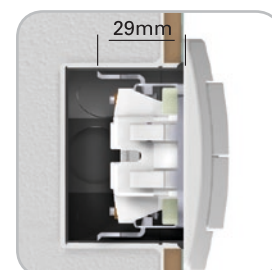

Nožice omogućavaju dublje pričvršćivanje (i preko keramičkih pločica i sl.)

Fixing claws enable deeper fixing (also through ceramic tiles, etc.)



Sve sklopke na prednjoj strani nose vidljivu oznaku.

All switches have a clear identification in the back.

Sklopke su testirane prema međunarodnim standardima koji jamče sigurnost i dug vijek trajanja.

Switches were tested according to international standards which guarantee safety and long life span.



Pouzdanost preklopa osiguravaju kontakti izrađeni od srebrne legure (AgNi).

Contacts made of silver alloy (Ag-Ni) guarantee safe switching.

TEM





<i>SKLOPKE SE</i> <i>SWITCHES SE</i>		172
<i>TIPKE TE</i> <i>BUTTONS TE</i>		176
<i>OSVJETLJENJE IA</i> <i>ILLUMINATION IA</i>		177
<i>UTIČNICE VE</i> <i>SOCKETS VE</i>		179
<i>KOMUNIKACIJE KE</i> <i>COMMUNICATIONS KE</i>		183
<i>POKLOPCI PE</i> <i>COVERS PE</i>		187
<i>ELEKTRONIKA EE</i> <i>ELECTRONICS EE</i>		188
<i>PRIBOR AE</i> <i>ACCESSORIES AE</i>		193
<i>OKVIRI OE</i> <i>SURROUNDS OE</i>		195

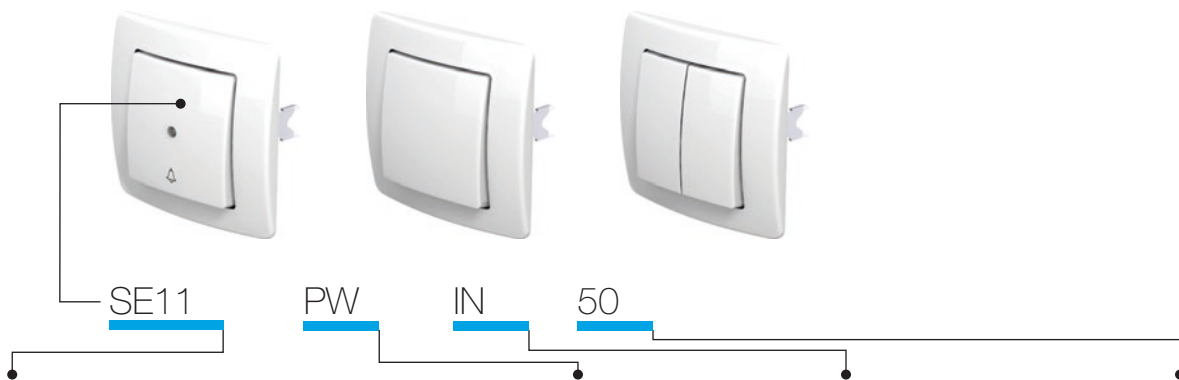

tip type	naziv description	tehnički podaci technical data	boja colour	opcijski podaci 1 optional data 1	opcijski podaci 2 optional data 2
SE10	SKLOPKA JEDNOPOLNA SWITCH 1WAY	10AX 250V~	<input type="checkbox"/> PW bijela sjajna polar white	NT neutralna neutral	50
SE11	TIPKALO JEDNOPOLNO PUSH BUTTON 1WAY	10A 250V~	<input type="checkbox"/> IW bež sjajna ivory white	IN indikator indicator	51
SE22	SKLOPKA DVOPOLNA SWITCH 2POLE	16AX 250V~	<input type="checkbox"/> ES srebrna mat elox silver		03
...	<input type="checkbox"/> CO bijeli duroplast white thermoset		04
...	<input type="checkbox"/> NB crna sjajna night black		...

SKLOPKA JEDNOPOLNA 16AX 250V ~



SE10

- 10AX 250V~, tip SE10
- sukladno normi EN 60669-1
- bezvijčani kontakti 1,5-2,5mm²

SWITCH 1WAY 16AX 250V~

- 10AX 250V~, type SE10
- in accordance with EN 60669-1
- plug-in contacts 1.5-2.5mm²

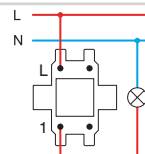

TIPKALO JEDNOPOLNO 10A 250V ~



SE11

- 10A 250V~, tip SE11
- sukladno normi EN 60669-1
- bezvijčani kontakti 1,5-2,5mm²

PUSH BUTTON 1WAY 10A 250V~

- 10A 250V~, type SE11
- in accordance with EN 60669-1
- plug-in contacts 1.5-2.5mm²

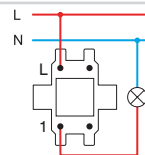

SKLOPKA DVOPOLNA 16AX 250V ~



SE22

- 16AX 250V~, tip SE22
- sukladno normi EN 60669-1
- vijčano pričvršćivanje vodiča presjeka 1,5-2,5mm²
- samo u kombinaciji s tipkom TE10__NT03

SWITCH 2POLE 16AX 250V~

- 16AX 250V~, type SE22
- in accordance with EN 60669-1
- screw contacts 1.5-2.5mm²
- only in combination with button TE10__NT03

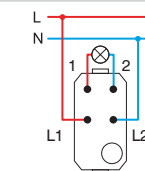
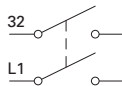

SKLOPKA SERIJSKA JEDNOPOLNA 10AX 250V ~



SE50

- 10AX 250V~, tip SE50
- sukladno normi EN 60669-1
- bezvijčani kontakti 1,5-2,5mm²

SWITCH 2GANG-1WAY 10AX 250V~

- 10AX 250V~, type SE50
- in accordance with EN 60669-1
- plug-in contacts 1.5-2.5mm²

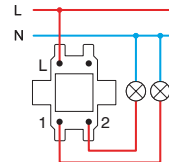
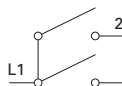

TIPKALO SERIJSKO-JEDNOPOLNO 10A 250V ~



SE51

- 10A 250V~, tip SE51
- sukladno normi EN 60669-1
- bezvijčani kontakti 1,5-2,5mm²

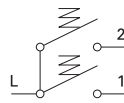

PUSH BUTTON 2GANG-1WAY 10A 250V~

- 10A 250V~, type SE51
- in accordance with EN 60669-1
- plug-in contacts 1.5-2.5mm²

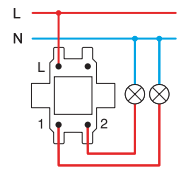

SKLOPKA ŽALUZIJSKA 10AX 250V ~



SE52

- 10AX 250V~, tip SE52
- sukladno normi EN 60669-1
- bezvijčani kontakti 1,5-2,5mm²
- s mehaničkom blokadom

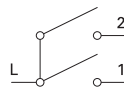

SWITCH SHUTTERS 10AX 250V~

- 10AX 250V~, type SE52
- in accordance with EN 60669-1
- plug-in contacts 1.5-2.5mm²
- with mechanical interblock

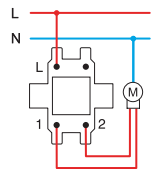

TIPKALO ŽALUZIJSKO 10A 250V ~



SE53

- 10A 250V~, tip SE53
- sukladno normi EN 60669-1
- bezvijčani kontakti 1,5-2,5mm²
- s mehaničkom blokadom

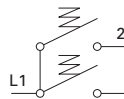

PUSH BUTTON SHUTTERS 10A 250V~

- 10A 250V~, type SE53
- in accordance with EN 60669-1
- plug-in contacts 1.5-2.5mm²
- with mechanical interblock

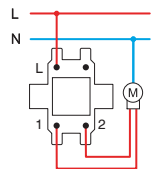

SKLOPKA IZMJENIČNA 10AX 250V ~



SE60

- 10AX 250V~, tip SE60
- sukladno normi EN 60669-1
- bezvijčani kontakti 1,5-2,5mm²

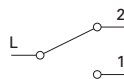

SWITCH 2WAY 10AX 250V~

- 10AX 250V~, type SE60
- in accordance with EN 60669-1
- plug-in contacts 1.5-2.5mm²

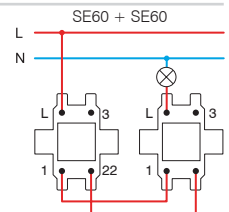

SKLOPKA IZMJENIČNA DVOSTRUKA 10AX 250V ~



SE63

- 10AX 250V~, tip SE63
- sukladno normi EN 60669-1
- bezvijčani kontakti 1,5-2,5mm²



SWITCH DOUBLE 2WAY 10AX 250V~

- 10AX 250V~, type SE63
- in accordance with EN 60669-1
- plug-in contacts 1.5-2.5mm²

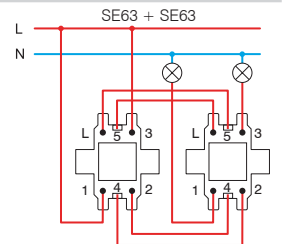

SKLOPKA KRIŽNA 10AX 250V ~



SE70

- 10AX 250V~, tip SE70
- sukladno normi EN 60669-1
- bezvijčani kontakti 1,5-2,5mm²



SWITCH INTERMEDIATE 10AX 250V~

- 10AX 250V~, type SE70
- in accordance with EN 60669-1
- plug-in contacts 1.5-2.5mm²

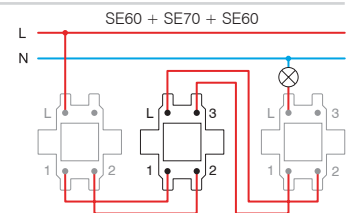

SKLOPKA JEDNOPOLNA 10AX 250V ~



- SE10PW
- SE10IW
- SE10ES
- SE10CO
- SE10NB

- 10AX 250V~, tip SE10
- sukladno normi EN 60669-1
- bezvižčani kontakti 1,5-2,5mm²

SWITCH 1WAY 10AX 250V~

- 10AX 250V~, type SE10
- in accordance with EN 60669-1
- plug-in contacts 1.5-2.5mm²



SKLOPKA JEDNOPOLNA 10AX 250V~ __ IN



- SE10PWIN
- SE10IWIN
- SE10ESIN
- SE10COIN
- SE10NBIN

- IN indikator
- 10AX 250V~, tip SE10
- sukladno normi EN 60669-1
- bezvižčani kontakti 1,5-2,5mm²

SWITCH 1WAY 10AX 250V~ __ IN

- IN indicator
- 10AX 250V~, type SE10
- in accordance with EN 60669-1
- plug-in contacts 1.5-2.5mm²



TIPKALO JEDNOPOLNO 10A 250V ~



- SE11PW
- SE11IW
- SE11ES
- SE11CO
- SE11NB

- 10A 250V~, tip SE11
- sukladno normi EN 60669-1
- bezvižčani kontakti 1,5-2,5mm²

PUSH BUTTON 1WAY 10A 250V~

- 10A 250V~, type SE11
- in accordance with EN 60669-1
- plug-in contacts 1.5-2.5mm²



TIPKALO JEDNOPOLNO 10A 250V ~ __ TI 50



- SE11PWTI50
- SE11IWTI50
- SE11ESTI50
- SE11COTI50
- SE11NBTI50

- TI 50 indikator zvono + neonska tinjalica
- 10A 250V~, tip SE11
- sukladno normi EN 60669-1
- bezvižčani kontakti 1,5-2,5mm²

PUSH BUTTON 1WAY 10A 250V~ __ TI 50

- TI 50 indicator bell+neon lamp
- 10A 250V~, type SE11
- in accordance with EN 60669-1
- plug-in contacts 1.5-2.5mm²



TIPKALO JEDNOPOLNO 10A 250V ~ __ TI 51



- SE11PWTI51
- SE11IWTI51
- SE11ESTI51
- SE11COTI51
- SE11NBTI51

- TI 51 indikator svjetlo + neonska tinjalica
- 10A 250V~, tip SE11
- sukladno normi EN 60669-1
- bezvižčani kontakti 1,5-2,5mm²

PUSH BUTTON 1WAY 10A 250V~ __ TI 51

- TI 51 indicator light+neon lamp
- 10A 250V~, type SE11
- in accordance with EN 60669-1
- plug-in contacts 1.5-2.5mm²



TIPKALO JEDNOPOLNO 10A 250V ~ __ IL



- SE11PWIL
- SE11IWIL
- SE11ESIL
- SE11COIL
- SE11NBIL

- IL natpisna pločica
- 10A 250V~, tip SE11
- sukladno normi EN 60669-1
- bezvižčani kontakti 1,5-2,5mm²

PUSH BUTTON 1WAY 10A 250V~ __ IL

- IL inscription plate
- 10A 250V~, type SE11
- in accordance with EN 60669-1
- plug-in contacts 1.5-2.5mm²



SKLOPKA DVOPOLNA 16AX 250V~ __ NT 03



- SE22PWNT03
- SE22IWNNT03
- SE22ESNT03
- SE22NBNT03

- NT 03 neutralna 0-1
- 16AX 250V~, tip SE22
- sukladno normi EN 60669-1
- vijčano pričvršćivanje vodiča presjeka 1,5-2,5mm²

SWITCH 2POLE 16AX 250V~ __ NT 03

- NT 03 neutral 0-1
- 16AX 250V~, type SE22
- in accordance with EN 60669-1
- screw contacts 1.5-2.5mm²





- SE50PW
- SE50IW
- SE50ES
- SE50CO
- SE50NB

SKLOPKA SERIJSKA-JEDNOPOLNA 10AX 250V ~

- 10AX 250V~, tip SE50
- sukladno normi EN 60669-1
- bezvijčani kontakti 1,5-2,5mm²

SWITCH 2GANG-1WAY 10AX 250V~

- 10AX 250V~, type SE50
- in accordance with EN 60669-1
- plug-in contacts 1.5-2.5mm²



- SE51PW
- SE51IW
- SE51ES
- SE51CO
- SE51NB

TIPKALO SERIJSKO-JEDNOPOLNO 10A 250V ~

- 10A 250V~, tip SE51
- sukladno normi EN 60669-1
- bezvijčani kontakti 1,5-2,5mm²

PUSH BUTTON 2GANG-1WAY 10A 250V~

- 10A 250V~, type SE51
- in accordance with EN 60669-1
- plug-in contacts 1.5-2.5mm²



- SE52PWNT09
- SE52IWNT09
- SE52ESNT09
- SE52CONT09
- SE52NBNT09

SKLOPKA ŽALUZIJSKA 10AX 250V ~ __ NT 09

- NT 09 neutralno gore-dolje
- 10AX 250V~, tip SE52
- sukladno normi EN 60669-1
- bezvijčani pričvršćivanje vodiča presjeka 1,5-2,5 mm²
- s mehaničkom blokadom

SWITCH SHUTTERS 10AX 250V~ __ NT 09

- NT 09 neutral up-down
- 10AX 250V~, type SE52
- in accordance with EN 60669-1
- plug-in contacts 1.5-2.5mm²
- with mechanical interblock



- SE53PWTI50
- SE53IWTI50
- SE53ESTI50
- SE53COTI50
- SE53NBTI50

TIPKALO ŽALUZIJSKO 10A 250V~ __ NT 09

- NT 09 neutralno gore-dolje
- 10A 250V~, tip SE53
- sukladno normi EN 60669-1
- bezvijčani kontakti 1,5-2,5mm²
- s mehaničkom blokadom

PUSH BUTTON SHUTTERS 10A 250V~ __ NT 09

- NT 09 neutral up-down
- 10A 250V~, type SE53
- in accordance with EN 60669-1
- plug-in contacts 1.5-2.5mm²
- with mechanical interblock



- SE60PW
- SE60IW
- SE60ES
- SE60CO
- SE60NB

SKLOPKA IZMJENIČNA 10AX 250V ~

- 10AX 250V~, tip SE60
- sukladno normi EN 60669-1
- bezvijčani kontakti 1,5-2,5mm²

SWITCH 2WAY 10AX 250V~

- 10AX 250V~, type SE60
- in accordance with EN 60669-1
- plug-in contacts 1.5-2.5mm²



- SE63PW
- SE63IW
- SE63ES
- SE63CO
- SE63NB

SKLOPKA IZMJENIČNA DVOSTRUKA 10AX 250V ~

- 10AX 250V~, tip SE63
- sukladno normi EN 60669-1
- bezvijčani kontakti 1,5-2,5mm²

SWITCH DOUBLE 2WAY 10AX 250V~

- 10AX 250V~, type SE63
- in accordance with EN 60669-1
- plug-in contacts 1.5-2.5mm²



- SE70PW
- SE70IW
- SE70ES
- SE70CO
- SE70NB

SKLOPKA KRIŽNA 10AX 250V ~

- 10AX 250V~, tip SE70
- sukladno normi EN 60669-1
- bezvijčani kontakti 1,5-2,5mm²

SWITCH INTERMEDIATE 10AX 250V~

- 10AX 250V~, type SE70
- in accordance with EN 60669-1
- plug-in contacts 1.5-2.5mm²

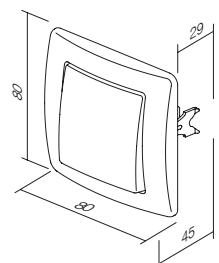
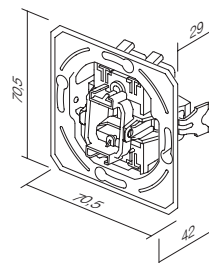

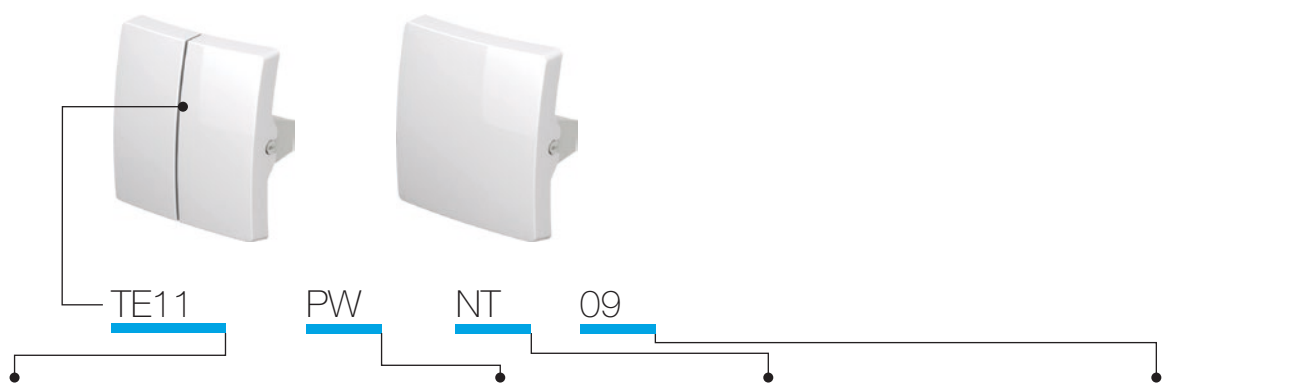

tip type	naziv description	boja colour	opcijski podaci 1 optional data 1	opcijski podaci 2 optional data 2
TE10	TIPKA OBIČNA BUTTON 1GANG	<input type="checkbox"/> PW bijela sjajna polar white	NT neutralna neutral	50
TE11	TIPKA SERIJSKA BUTTON 2GANG	<input type="checkbox"/> IW bež sjajna ivory white	IN indikator indicator	51
...	...	<input type="checkbox"/> ES srebrna mat elox silver		03
...	...	<input type="checkbox"/> CO bijeli duroplast white thermoset		04
...	...	<input type="checkbox"/> NB crna sjajna night black		

TIPKA OBIČNA



TE10PW

TE10IW

TE10ES

TE10CO

TE10NB

- tipka zajedno s nosačem

BUTTON 1GANG

- button together with carrier



TIPKA INDIKATOR



TE10PWIN

TE10IWIN

TE10ESIN

TE10COIN

TE10NBIN

- tipka zajedno s nosačem

BUTTON INDICATOR

- button together with carrier



TIPKA S NATPISNOM PLOČICOM



TE13PWIL

TE13IWIL

TE13ESIL

TE13NBIL

- tipka zajedno s nosačem, s natpisnom pločicom

BUTTON WITH INSCRIPTION PLATE

- button together with carrier, with inscription plate



TIPKA SERIJSKA



TE11PW

TE11IW

TE11ES

TE11CO

TE11NB

- tipka serijska zajedno s nosačem

BUTTON 2GANG

- button 2gang together with carrier



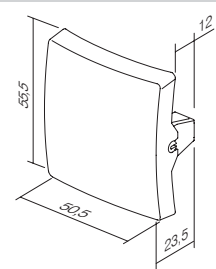
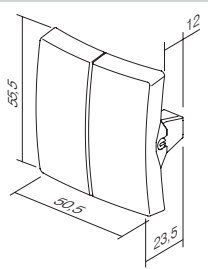

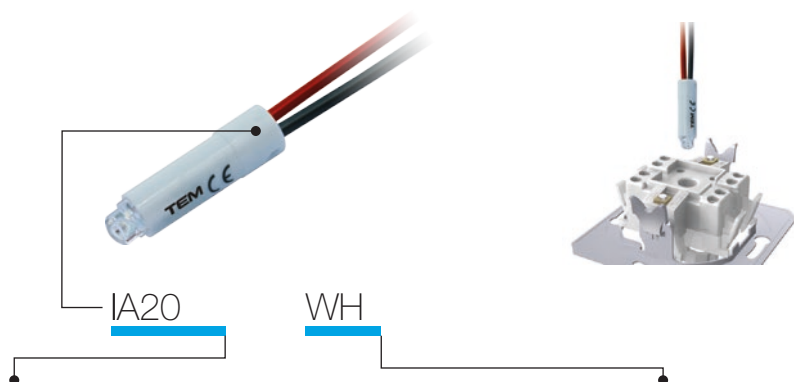

tip type	naziv description	tehnički podaci technical data	boja colour
IA10	NEONSKA TINJALICA NEON LAMP	230V~ 0,34W	<input type="checkbox"/> WH bijela white
IA20	LED TINJALICA LED LAMP	230V~ 0,40W	<input checked="" type="checkbox"/> BL plava blue
IA21	LED TINJALICA LED LAMP	24V AC/DC 0,20W	<input checked="" type="checkbox"/> RD crvena red
·	·	·	<input checked="" type="checkbox"/> GR zelena green
·	·	·	<input checked="" type="checkbox"/> OR narančasta orange

NEONSKA TINJALICA 230V~ 0,34W



IA10OR

- za indicaciju, osvjetljenje ili stalno osvjetljenje sklopke
- u kombinaciji s tipkom s indikatorom

NEON LAMP 230V~ 0,34W

- for indication, illumination or constant illumination of switch
- in combination with button with indicator

LED TINJALICA 230V AC/DC 0,40W



IA20WH
 IA20GR
 IA20RD
 IA20BL

- za indicaciju, osvjetljenje ili stalno osvjetljenje sklopke
- u kombinaciji s tipkom s indikatorom

LED LAMP 230V AC/DC 0,40W

- for indication, illumination or constant illumination of switch
- in combination with button with indicator

LED TINJALICA 24V AC/DC 0,20W



IA21WH
 IA21RD

- za indicaciju, osvjetljenje ili stalno osvjetljenje sklopke
- u kombinaciji s tipkom s indikatorom

LED LAMP 24V AC/DC 0,20W

- for indication, illumination or constant illumination of switch
- in combination with button with indicator

LED TINJALICA 12V AC/DC 0,10W



IA22WH
 IA22RD

- za indicaciju, osvjetljenje ili stalno osvjetljenje sklopke
- u kombinaciji s tipkom s indikatorom

LED LAMP 12V AC/DC 0,10W

- for indication, illumination or constant illumination of switch
- in combination with button with indicator

* Indikacija /
Indication

Rasvjetna tijela /
Illumination

* Osvjetljenje stalno uključeno /
Illumination always on

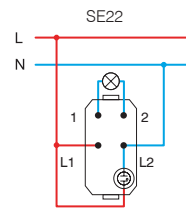
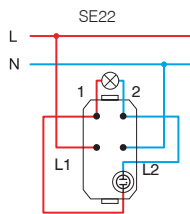
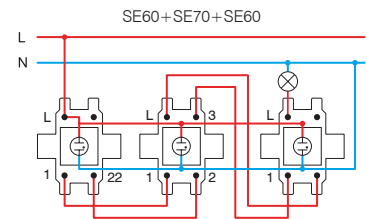
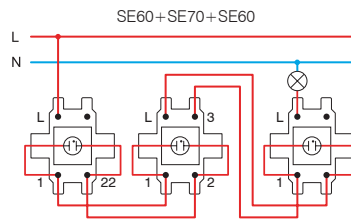
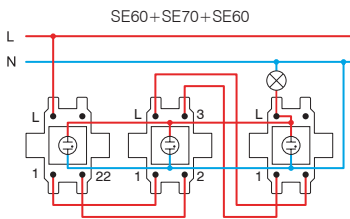
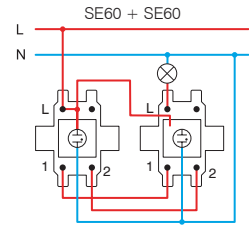
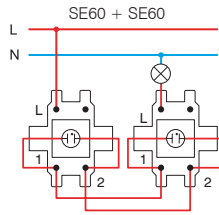
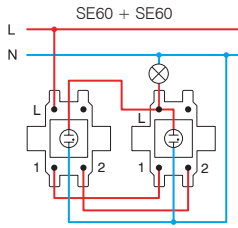
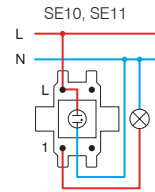
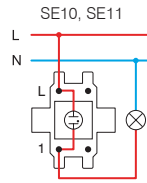
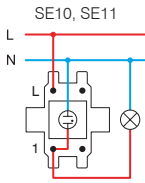

* spojne shema kompaktne fluorescentne tinjalice (CFL) /
wiring scheme for compact fluid lamp (CFL)

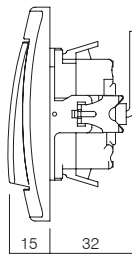

S O C K E T S V E

VE11 PT XO KS

tip type	naziv description	tehnički podaci technical data	opcijski podaci 1 optional data 1	opcijski podaci 2 optional data 2
VE10	ŠUKO UTIČNICA SOCKET SCHUKO	2P+E 16A 250V~	XO bez okvira without cover plate	KS zaštita za djecu child protection
VE11	ŠUKO UTIČNICA+POKLOPAC SOCKET SCHUKO+COVER	2P+E 16A 250V~		
VE12	ŠUKO UTIČNICA SOCKET SCHUKO	2P+E 16A 250V~ BV	KS zaštita za djecu child protection	
⋮	⋮	⋮		
⋮	⋮	⋮		

boja
colour

<input type="checkbox"/> PW bijela sjajna polar white	<input checked="" type="checkbox"/> PT bijela+prozirna white+transparent	<input type="checkbox"/> PP bijela+bijela white+white
<input checked="" type="checkbox"/> IW bež sjajna ivory white	<input checked="" type="checkbox"/> IT bež+prozirna ivory+transparent	<input checked="" type="checkbox"/> II bež+bež ivory+ivory
<input type="checkbox"/> ES srebrna mat elox silver	<input checked="" type="checkbox"/> ST srebrna+prozirna silver+transparent	<input type="checkbox"/> SS srebrna+srebrna silver+silver
<input type="checkbox"/> CO bijeli duroplast white thermoset	<input checked="" type="checkbox"/> CT bijela+prozirna white+transparent	<input checked="" type="checkbox"/> BB crna+crna black+black
<input checked="" type="checkbox"/> NB crna sjajna night black	<input checked="" type="checkbox"/> BT crna+prozirna black+transparent	<input checked="" type="checkbox"/> RR crvena+crvena red+red
<input checked="" type="checkbox"/> RD crvena red	<input checked="" type="checkbox"/> RT crvena+prozirna red+transparent	<input checked="" type="checkbox"/> GG zelena+zelena green+green
<input checked="" type="checkbox"/> GR zelena green	<input checked="" type="checkbox"/> GT zelena+prozirna green+transparent	<input checked="" type="checkbox"/> OO narančasta+narančasta orange+orange
<input checked="" type="checkbox"/> OR narančasta orange	<input checked="" type="checkbox"/> OT narančasta+prozirna orange+transparent	



šuko – sukladno normi EN 60884-1, CEE7 (lista standarda III)

francuska – sukladno normi NF C 61-314 (lista standarda V)

schuko - in accordance with EN 60884-1, CEE7 (standard sheet III)

French - in accordance with NF C 61-314 (standard sheet V)

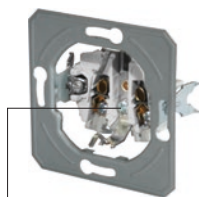

• vijčano pričvršćivanje vodiča
screw contacts

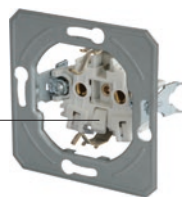

• BV bezvijčano pričvršćivanje
BV plug-in contacts



• vijčano pričvršćivanje vodiča
screw contacts



• BV bezvijčano pričvršćivanje
BV plug-in contacts

UTIČNICA ŠUKO 2P + E 16A 250V ~ __ XO

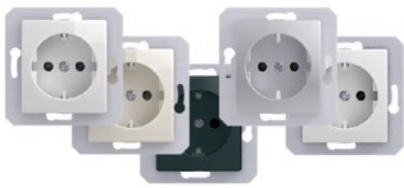

- VE10PWXO
- VE10IWXO
- VE10ESXO
- VE10COXO
- VE10NBXO
- VE10RDXO
- VE10GRXO
- VE10ORXO

- vijčano pričvršćivanje vodiča presjeka 1,5-2,5mm²
- XO bez okvira
- 2P+E šuko
- 16A 250V~, tip VE10

SOCKET SCHUKO 2P+E 16A 250V~ __ XO

- screw contacts 1.5-2.5mm²
- XO without surround
- 2P+E schuko
- 16A 250V~, type VE10



UTIČNICA ŠUKO + POKLOPAC 2P + E 16A 250V ~ __ XO



- VE11PTXO
- VE11ITXO
- VE11STXO
- VE11BTXO

- vijčano pričvršćivanje vodiča presjeka 1,5-2,5mm²
- XO bez okvira
- 2P+E šuko+poklopac
- 16A 250V~, tip VE11

SOCKET SCHUKO+COVER 2P+E 16A 250V~ __ XO

- screw contacts 1.5-2.5mm²
- XO without surround
- 2P+E schuko+cover
- 16A 250V~, type VE11



UTIČNICA ŠUKO 2P + E 16A 250V ~ BV __ XO

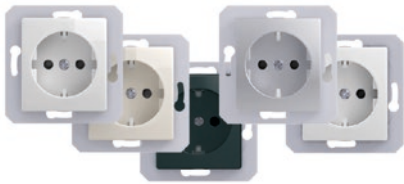

- VE12PWXO
- VE12IWXO
- VE12ESXO
- VE12COXO
- VE12NBXO
- VE12RDXO
- VE12GRXO
- VE12ORXO

- BV bezvijčani kontakti 1,5-2,5mm²
- XO bez okvira
- 2P+E šuko
- 16A 250V~, tip VE12

SOCKET SCHUKO 2P+E 16A 250V~ BV __ XO

- BV plug-in contacts 1.5-2.5mm²
- XO without surround
- 2P+E schuko
- 16A 250V~, type VE12



UTIČNICA ŠUKO + POKLOPAC 2P + E 16A 250V~ BV __ XO



- VE13PTXO
- VE13ITXO
- VE13STXO
- VE13BTXO
- VE13PPXO

- BV bezvijčani kontakti 1,5-2,5mm²
- XO bez okvira
- 2P+E šuko+poklopac
- 16A 250V~, tip VE13

SOCKET SCHUKO+COVER 2P+E 16A 250V~ BV __ XO

- BV plug-in contacts 1.5-2.5mm²
- XO without surround
- 2P+E schuko+cover
- 16A 250V~, type VE13



UTIČNICA ŠUKO 2P + E 16A 250V ~



- VE10PW
- VE10IW
- VE10ES
- VE10CO
- VE10NB

- vijčano pričvršćivanje vodiča presjeka 1,5-2,5mm²
- 2P+E šuko
- 16A 250V~, tip VE10

SOCKET SCHUKO 2P+E 16A 250V~

- screw contacts 1.5-2.5mm²
- 2P+E schuko
- 16A 250V~, type VE10



UTIČNICA ŠUKO + POKLOPAC 2P + E 16A 250V~



- VE11PT
- VE11IT
- VE11ST
- VE11CT
- VE11BT

- vijčano pričvršćivanje vodiča presjeka 1,5-2,5mm²
- 2P+E šuko+poklopac
- 16A 250V~, tip VE11

SOCKET SCHUKO+COVER 2P+E 16A 250V~

- screw contacts 1.5-2.5mm²
- 2P+E schuko+cover
- 16A 250V~, type VE11



UTIČNICA ŠUKO 2P + E 16A 250V ~ BV



- VE12PW
- VE12IW
- VE12ES
- VE12CO
- VE12NB

- BV bezvijčani kontakti 1,5-2,5mm²
- 2P+E šuko
- 16A 250V~, tip VE12

SOCKET SCHUKO 2P+E 16A 250V~ BV

- BV plug-in contacts 1.5-2.5mm²
- 2P+E schuko
- 16A 250V~, type VE12



UTIČNICA ŠUKO + POKLOPAC 2P + E 16A 250V ~ BV



- VE13PT
- VE13IT
- VE13ST
- VE13CT
- VE13BT

- BV bezvijčani kontakti 1,5-2,5mm²
- 2P+E šuko+poklopac
- 16A 250V~, tip VE13

SOCKET SCHUKO+COVER 2P+E 16A 250V~ BV

- BV plug-in contacts 1.5-2.5mm²
- 2P+E schuko+cover
- 16A 250V~, type VE13



	<ul style="list-style-type: none"> <input type="checkbox"/> VE40PWXO <input type="checkbox"/> VE40IWXO <input type="checkbox"/> VE40ESXO <input type="checkbox"/> VE40COXO <input checked="" type="checkbox"/> VE40NBXO <input checked="" type="checkbox"/> VE40RDXO <input checked="" type="checkbox"/> VE40GRXO <input checked="" type="checkbox"/> VE40ORXO 	UTIČNICA FRANCUSKA 2P + E 16A 250V ~ __ XO	<ul style="list-style-type: none"> - vijčano pričvršćivanje vodiča presjeka 1,5-2,5mm² - XO bez okvira - 2P+E francuska - 16A 250V~, tip VE40 	
	<ul style="list-style-type: none"> <input checked="" type="checkbox"/> VE41PTXO <input checked="" type="checkbox"/> VE41ITXO <input checked="" type="checkbox"/> VE41STXO <input checked="" type="checkbox"/> VE41PTXO <input checked="" type="checkbox"/> VE41BTXO <input type="checkbox"/> VE41PPXO 	UTIČNICA FRANCUSKA + POKLOPAC 2P + E 16A 250V~ __ XO	<ul style="list-style-type: none"> - vijčano pričvršćivanje vodiča presjeka 1,5-2,5mm² - XO bez okvira - 2P+E francuska+poklopac - 16A 250V~, tip VE41 	
	<ul style="list-style-type: none"> <input type="checkbox"/> VE42PWXO <input type="checkbox"/> VE42IWXO <input type="checkbox"/> VE42ESXO <input type="checkbox"/> VE42COXO <input checked="" type="checkbox"/> VE42NBXO <input checked="" type="checkbox"/> VE42RDXO <input checked="" type="checkbox"/> VE42GRXO <input checked="" type="checkbox"/> VE42ORXO 	UTIČNICA FRANCUSKA 2P + E 16A 250V~ BV __ XO	<ul style="list-style-type: none"> - BV bezvijčani kontakti 1,5-2,5mm² - XO bez okvira - utičnica sa zaštitnim kontaktom francuska - 16A 250V~, tip VE42 	
	<ul style="list-style-type: none"> <input checked="" type="checkbox"/> VE43PTXO <input checked="" type="checkbox"/> VE43ITXO <input checked="" type="checkbox"/> VE43STXO <input checked="" type="checkbox"/> VE43PTXO <input checked="" type="checkbox"/> VE43BTXO <input type="checkbox"/> VE43PPXO 	UTIČNICA FRANCUSKA + POKLOPAC 2P + E 16A 250V~ BV __ XO	<ul style="list-style-type: none"> - BV bezvijčani kontakti 1,5-2,5mm² - XO bez okvira - 2P+E francuska+poklopac - 16A 250V~, tip VE43 	
	<ul style="list-style-type: none"> <input type="checkbox"/> VE40PW <input type="checkbox"/> VE40IW <input type="checkbox"/> VE40ES <input type="checkbox"/> VE40CO <input checked="" type="checkbox"/> VE40NB 	UTIČNICA FRANCUSKA 2P + E 16A 250V ~	<ul style="list-style-type: none"> - vijčano pričvršćivanje vodiča presjeka 1.5-2.5mm² - 2P+E francuska - 16A 250V~, tip VE40 	
	<ul style="list-style-type: none"> <input type="checkbox"/> VE41PT <input type="checkbox"/> VE41IT <input type="checkbox"/> VE41ST <input type="checkbox"/> VE41CT <input checked="" type="checkbox"/> VE41BT 	UTIČNICA FRANCUSKA + POKLOPAC 2P + E 16A 250V~	<ul style="list-style-type: none"> - vijčano pričvršćivanje vodiča presjeka 1,5-2,5mm² - 2P+E francuska+poklopac - 16A 250V~, tip VE41 	
	<ul style="list-style-type: none"> <input type="checkbox"/> VE42PW <input type="checkbox"/> VE42IW <input type="checkbox"/> VE42ES <input type="checkbox"/> VE42CO <input checked="" type="checkbox"/> VE42NB 	UTIČNICA FRANCUSKA 2P + E 16A 250V ~ BV	<ul style="list-style-type: none"> - BV bezvijčani kontakti 1,5-2,5mm² - utičnica sa zaštitnim kontaktom francuska - 16A 250V~, tip VE42 	
	<ul style="list-style-type: none"> <input type="checkbox"/> VE43PT <input type="checkbox"/> VE43IT <input type="checkbox"/> VE43ST <input type="checkbox"/> VE43CT <input checked="" type="checkbox"/> VE43BT 	UTIČNICA FRANCUSKA + POKLOPAC 2P + E 16A 250V ~ BV	<ul style="list-style-type: none"> - BV bezvijčani kontakti 1,5-2,5mm² - 2P+E francuska+poklopac - 16A 250V~, tip VE43 	

UTIČNICA ŠUKO DVOSTRUKA 2P + E 16A 250V~



- VE16PWKS
- VE16WKS
- VE16ESKS
- VE16NBKS

- 2P+E šuko dvostruka
- 16A 250V~, tip VE16
- sukladno normama IEC 60884-1, CEE7
- vijčano pričvršćivanje vodiča presjeka 1,5-2,5 mm²
- KS zaštita za djecu od dodira kontakta

SOCKET SCHUKO DOUBLE 2P+E 16A 250V~

- 2P+E schuko double
- 16A 250V~, type VE16
- in accordance with IEC 60884-1, CEE7
- screw contacts 1.5-2.5 mm²
- KS build-in child protection – shuttered live contacts



UTIČNICA FRANCUSKA DVOSTRUKA 2P + E 16A 250V~



- VE46PWKS
- VE46WKS
- VE46ESKS
- VE46NBKS

- 2P + E francuska dvostruka
- 16A 250V~, tip VE46
- sukladno normama IEC 60884-1, CEE7; NF C 61-314, CSN 33 2318; PN-E 93201
- vijčano pričvršćivanje vodiča presjeka 1,5-2,5 mm²
- KS zaštita za djecu od dodira kontakta

SOCKET FRENCH DOUBLE 2P+E 16A 250V~

- 2P+E French double
- 16A 250V~, type VE46
- in accordance with IEC 60884-1, CEE7; NF C 61-314, CSN 33 2318; PN-E 93201
- screw contacts 1.5-2.5 mm²
- KS build-in child protection – shuttered live contacts



UTIČNICA 2P 16A 250V ~



- VE30PW
- VE30IW
- VE30ES
- VE30NB

- 2P bez voda za uzemljenje
- 16A 250V ~
- sukladno normama EN 60884-1, CEE7 (lista standarda I)
- vijčano pričvršćivanje vodiča presjeka 1,5-2,5mm²

SOCKET 2P 16A 250V~

- 2P without earthing contact
- 16A 250V~
- in accordance with EN 60884-1, CEE7 (standard sheet I)
- screw contacts 1.5-2.5mm²

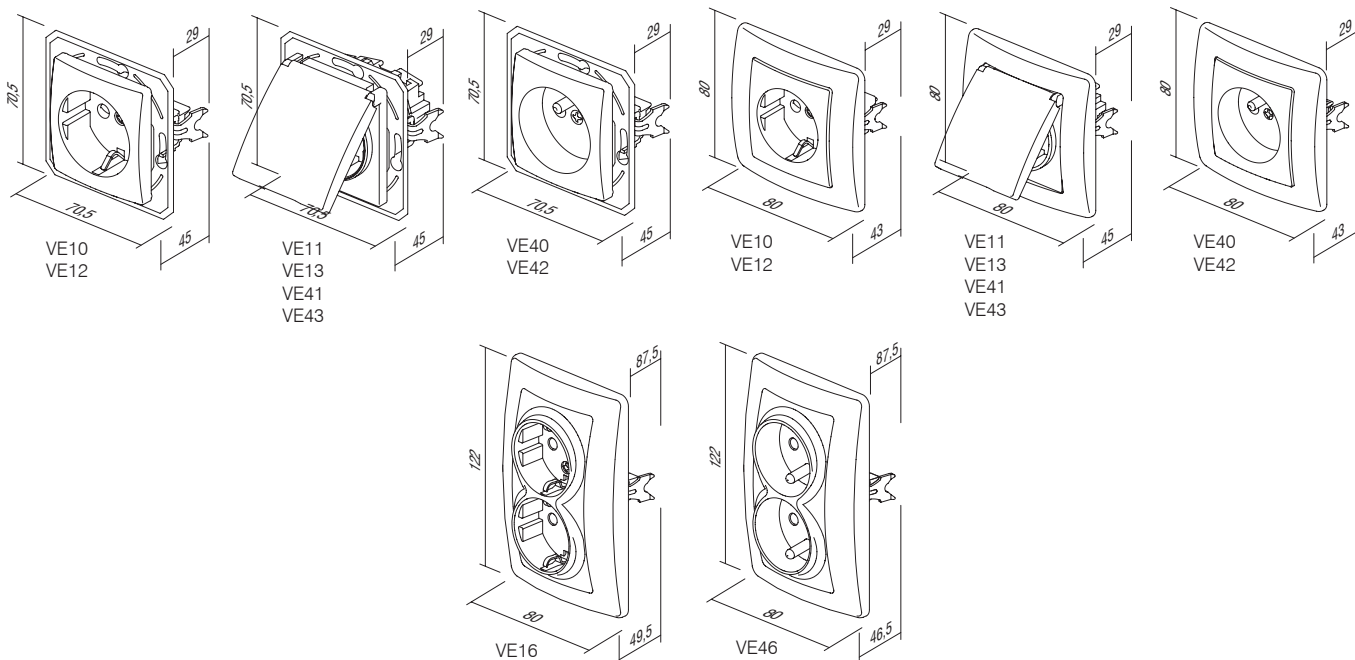



tip type	naziv description	tehnički podaci technical data	boja colour
KE11	UTIČNICA TV-R ZAVRŠNA SOCKET TV-R END-LINE	2dB	<input type="checkbox"/> PW bijela sjajna polar white
KE12	UTIČNICA TV-R PROLAZNA SOCKET TV-R THROUGHPASS	8,5dB	<input type="checkbox"/> IW bež sjajna ivory white
KE16	UTIČNICA SAT-TV-R ZAVRŠNA SOCKET SAT-TV-R END-LINE	3dB	<input type="checkbox"/> ES srebrna mat elox silver
⋮	⋮	⋮	<input type="checkbox"/> CO bijeli duroplast white thermoset
⋮	⋮	⋮	<input type="checkbox"/> NB crna sjajna night black

UTIČNICA TV-R ZAVRŠNA 2dB



KE11

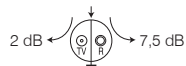

- TV-R završna
- propušta frekvenciju u rasponu 5÷862MHz
- prigušenje: R-7,5dB, TV-2dB
- sukladno normi EN 50083-1
- vijčano pričvršćivanje

SOCKET TV-R END-LINE 2dB

- TV-R end-line
- frequency range 5÷862MHz
- reduction: R-7.5dB, TV-2dB
- in accordance with EN 50083-1
- screw contacts

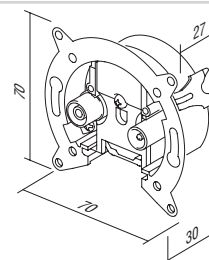

UTIČNICA TV-R PROLAZNA 8,5dB



KE12

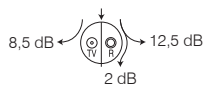

- TV-R prolazna
- propušta frekvenciju u rasponu 5÷862MHz
- prigušenje: R-12,5dB, TV-8,5dB, prolaz-2dB
- sukladno normi EN 50083-1
- vijčano pričvršćivanje

SOCKET TV-R THROUGHPASS 8,5dB

- TV-R throughpass
- frequency range 5÷862MHz
- reduction: R-12.5dB, TV-8.5dB, through-2dB
- in accordance with EN 50083-1
- screw contacts

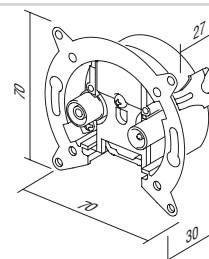

UTIČNICA SAT-TV-R ZAVRŠNA 3dB



KE16

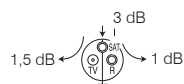

- SAT-TV-R završna
- propušta frekvenciju u rasponu 5÷2400MHz
- prigušenje: R-1dB, TV-1,5dB, SAT-3dB
- za ugradnju u okruglu kutiju Ø60 s nožicama ili vijcima
- sukladno normi EN 50083-1
- vijčano pričvršćivanje

SOCKET SAT-TV-R END-LINE 3dB

- SAT-TV-R end-line
- frequency range 5÷2400MHz
- reduction: R-1dB, TV-1.5dB, SAT-3dB
- for mounting in round box Ø60 with claws or screws
- in accordance with EN 50083-1
- screw contacts

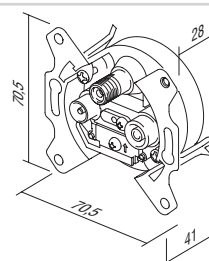

UTIČNICA TEL KS RJ11 6/4



KE36

- KS keystone standard pričvršćivanja
- RJ11 6/4
- sukladno normi IEC 60603-7

SOCKET TEL KS RJ11 6/4

- KS keystone fixing standard
- RJ11 6/4
- in accordance with IEC 60603-7

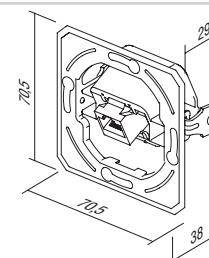



KE37

UTIČNICA CAT5e KS RJ45 8/8

- KS keystone standard pričvršćivanja
- CAT5e, RJ45 8/8
- sukladno normi IEC 60603-7

SOCKET CAT5e KS RJ45 8/8

- KS keystone fixing standard
- CAT5e, RJ45 8/8
- in accordance with IEC 60603-7

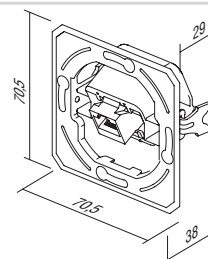

KE38

UTIČNICA TEL KS DVOSTRUKA 2x RJ11 6/4

- KS keystone standard pričvršćivanja
- 2x RJ11 6/4
- sukladno normi IEC 60603-7

SOCKET TEL KS DOUBLE 2x RJ11 6/4

- KS keystone fixing standard
- 2x RJ11 6/4
- in accordance with IEC 60603-7

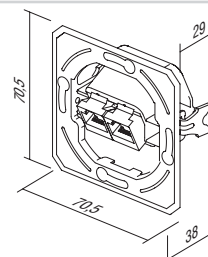

KE39

UTIČNICA CAT5e KS DVOSTRUKA 2x RJ45 8/8

- KS keystone standard pričvršćivanja
- 2x CAT5e, RJ45 8/8
- sukladno normi IEC 60603-7

SOCKET CAT5e KS DOUBLE 2x RJ45 8/8

- KS keystone fixing standard
- 2x CAT5e, RJ45 8/8
- in accordance with IEC 60603-7

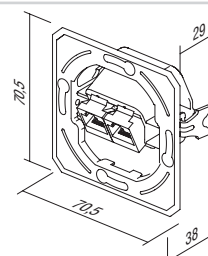

KE45

ADAPTER KS JEDNOSTRUKI

- KS keystone standard priključivanja - jednostruki
- AMP, Avaya, Brandrex, FMT, Mfico, Tyco, ...
- nije ugrađen komunikacijski modul

ADAPTER KS SINGLE

- KS keystone fixing standard - single
- AMP, Avaya, Brandrex, FMT, Mfico, Tyco, ...
- communication module not included

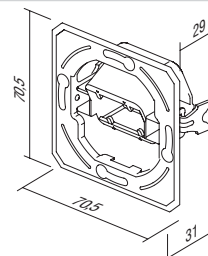

KE46

ADAPTER KS DVOSTRUKI

- KS keystone standard priključivanja - dvostruki
- AMP, Tyco, ...
- nije ugrađen komunikacijski modul

ADAPTER KS DOUBLE

- KS keystone fixing standard - double
- AMP, Tyco, ...
- communication module not included

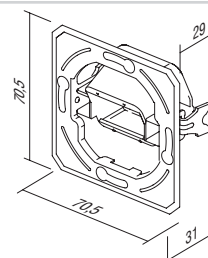

KE47

ADAPTER PD DVOSTRUKI

- standard pričvršćivanja PD Panduit Mini-COM – dvostruki
- nije ugrađen komunikacijski modul

ADAPTER PD DOUBLE

- PD Panduit Mini-COM fixing standard - double
- communication module not included

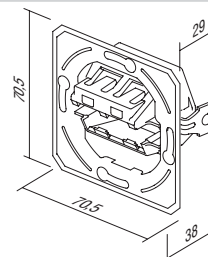



- KE10PW
- KE10IW
- KE10ES
- KE10CO
- KE10NB

UTIČNICA TV OSNOVNA 0dB

- TV osnovna
- prigušenje 0dB
- stražnji konektor – F standard

SOCKET TV BASIC 0dB

- TV basic
- reduction 0dB
- back connector – F standard



- KE11PW
- KE11IW
- KE11ES
- KE11CO
- KE11NB

UTIČNICA TV-R ZAVRŠNA 2dB

- TV-R završna
- propušta frekvenciju u rasponu 5÷862 MHz
- prigušenje: R-7,5dB, TV-2dB
- sukladno normi EN 50083-1
- vijčano pričvršćivanje

SOCKET TV-R END-LINE 2dB

- TV-R end-line
- frequency range 5÷862 MHz
- reduction: R-7.5dB, TV-2dB
- in accordance with EN 50083-1
- screw contact



- KE12PW
- KE12IW
- KE12ES
- KE12CO
- KE12NB

UTIČNICA TV-R PROLAZNA 8,5dB

- TV-R prolazna
- propušta frekvenciju u rasponu 5÷862 MHz
- prigušenje: R-12,5dB, TV-8,5dB, prolaz-2dB
- sukladno normi EN 50083-1
- vijčano pričvršćivanje

SOCKET TV-R TROUGH-PASS 8,5dB

- TV-R troughpass
- frequency range 5÷862 MHz
- reduction: R-12.5dB, TV-8.5dB, trough-2dB
- in accordance with EN 50083-1
- screw contacts



- KE16PW
- KE16IW
- KE16ES
- KE16CO
- KE16NB

UTIČNICA SAT-TV-R ZAVRŠNA 3dB

- SAT-TV-R završna
- propušta frekvenciju u rasponu 5÷2400 MHz
- prigušenje: R-1dB, TV-1,5dB, SAT-3dB
- sukladno normi EN 50083-1
- vijčano pričvršćivanje

SOCKET SAT-TV-R END-LINE 3dB

- SAT-TV-R end-line
- frequency range 5÷2400 MHz
- reduction: R-1dB, TV-1.5dB, SAT-3dB
- in accordance with EN 50083-1
- screw contacts



- KE22PW
- KE22IW
- KE22ES
- KE22CO
- KE22NB

UTIČNICA AUDIO 2xRCA

- audio 2xRCA
- pričvršćivanje vodiča lemljenjem

SOCKET AUDIO 2xRCA

- audio 2xRCA
- soldering connection of cable



- KE23PW
- KE23IW
- KE23ES
- KE23CO
- KE23NB

UTIČNICA AUDIO ZVUČNICI

- audio 2x Ø4 mm
- pričvršćivanje vodiča za zvučnike umetanjem ili banana utikačem Ø4 mm
- lemljenje spojeva kabela na stražnjoj strani

SOCKET AUDIO LOUDSPEAKERS

- audio 2x Ø4mm
- to accommodate speaker wire, banana plug Ø4mm or spades
- soldering connection of cable at the back side



UTIČNICA TEL KS RJ11 6/4



- KE36PW
- KE36IW
- KE36ES
- KE36CO
- KE36NB

- KS keystone standard pričvršćivanja
- RJ11 6/4
- sukladno normi IEC 60603-7

SOCKET TEL KS RJ11 6/4

- KS keystone fixing standard
- RJ11 6/4
- in accordance with IEC 60603-7



UTIČNICA CAT5e KS RJ45 8/8



- KE37PW
- KE37IW
- KE37ES
- KE37CO
- KE37NB

- KS keystone standard pričvršćivanja
- CAT5e, RJ45 8/8
- sukladno normi IEC 60603-7

SOCKET CAT5e KS RJ45 8/8

- KS keystone fixing standard
- CAT5e, RJ45 8/8
- in accordance with IEC 60603-7



UTIČNICA TEL KS DVOSTRUKA 2x RJ11 6/4



- KE38PW
- KE38IW
- KE38ES
- KE38CO
- KE38NB

- KS keystone standard pričvršćivanja
- 2x RJ11, 6/4
- sukladno normi IEC 60603-7

SOCKET TEL KS DOUBLE 2x RJ11 6/4

- KS keystone fixing standard
- 2x RJ11, 6/4
- in accordance with IEC 60603-7



UTIČNICA CAT5e KS DVOSTRUKA 2x RJ45 8/8



- KE39PW
- KE39IW
- KE39ES
- KE39CO
- KE39NB

- KS keystone standard pričvršćivanja
- 2x CAT5e, RJ45 8/8
- sukladno normi IEC 60603-7

SOCKET CAT5e KS DOUBLE 2x RJ45 8/8

- KS keystone fixing standard
- 2x CAT5e, RJ45 8/8
- in accordance with IEC 60603-7



UTIČNICA TEL LT RJ11 6/4



- KE35PW
- KE35IW
- KE35ES
- KE35CO
- KE35NB

- TEL LT vijak
- vijčano pričvršćivanje
- RJ11 6/4
- sukladno normi IEC 60603-7

SOCKET TEL LT RJ11 6/4

- TEL LT screw
- screw contacts
- RJ11 6/4
- in accordance with IEC 60603-7



ekonomik

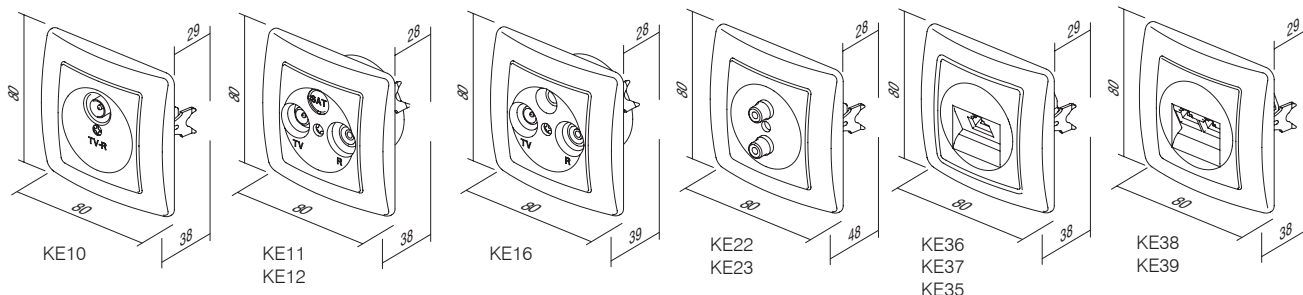

P O K L O P C I Z A K O M U N I K A C I J E K E

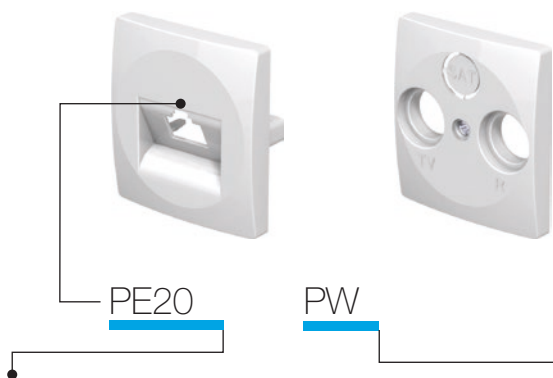

tip type	naziv description	tehnički podaci technical data	boja colour
PE10	POKLOPAC TV-R COVER TV-R	2P/3P	<input type="checkbox"/> PW bijela sjajna polar white
PE20	POKLOPAC KS JEDNOSTRUKI COVER KS SINGLE		<input type="checkbox"/> IW bež sjajna ivory white
PE21	POKLOPAC KS DVOSTRUKI COVER KS DOUBLE		<input type="checkbox"/> ES srebrna mat elox silver
...	<input type="checkbox"/> CO bijeli duroplast white thermoset
			<input type="checkbox"/> NB crna sjajna night black

POKLOPAC TV-R 2P/3P



- PE10PW
- PE10IW
- PE10ES
- PE10CO
- PE10NB

- poklopac TV-R, 2P ili 3P s vijkom

COVER TV-R 2P/3P

- TV-R cover, 2P or 3P with screw



POKLOPAC KS JEDNOSTRUKI



- PE20PW
- PE20IW
- PE20ES
- PE20CO
- PE20NB

- KS poklopac jednostrukim

COVER KS SINGLE

- KS cover single



POKLOPAC KS DVOSTRUKI



- PE21PW
- PE21IW
- PE21ES
- PE21NB

-KS poklopac dvostrukim

COVER KS DOUBLE

- KS cover double



POKLOPAC TAE/TDO

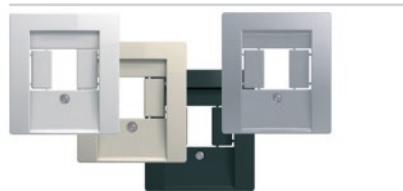

- PE30PW
- PE30IW
- PE30ES
- PE30NB

- TAE ili TDO poklopac s vijkom

COVER TAE/TDO

- TAE or TDO cover with screw

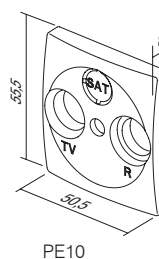
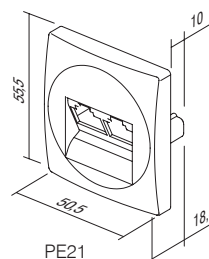
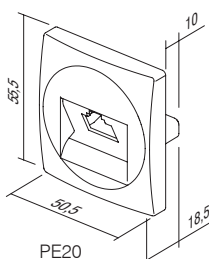
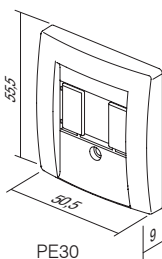

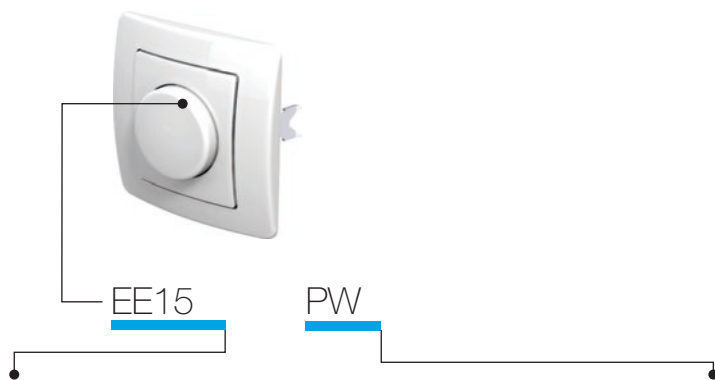

tip type	naziv description	tehnički podaci technical data	boja colour
EE15	REGULATOR OSVJETLJENJA ROTACIJSKI IZMJENIČNI <i>DIMMER ROTATIVE 2WAY</i>	RL 400W	<input type="checkbox"/> PW bijela sjajna <i>polar white</i>
EE16	REGULATOR OSVJETLJENJA ROTACIJSKI IZMJENIČNI <i>DIMMER ROTATIVE 2WAY</i>	RLC 400W	<input type="checkbox"/> IW bež sjajna <i>ivory white</i>
EE17	REGULATOR OSVJETLJENJA ROTACIJSKI <i>DIMMER ROTATIVE</i>	FAN 600VA	<input type="checkbox"/> ES srebrna mat <i>elox silver</i>
⋮	⋮	⋮	<input type="checkbox"/> CO bijeli duroplast <i>white thermoset</i>
⋮	⋮	⋮	<input type="checkbox"/> NB crna sjajna <i>night black</i>

REGULATOR OSVJETLJENJA ROTACIJSKI IZMJENIČNI RL 400W



EE15

- rotacijski s izmjeničnom sklopkom
- opterećenje RL, 40W – 400W
- moguća je kombinacija s izmjeničnom sklopkom
- povezivanje više regulatora osvjetljenja nije dopušteno
- sukladno normama EN 60669-1 i EN 60669-2-1
- bezvijčani kontakti 1,5mm²
- napajanje 230V ~ 50Hz
- unutarnji promjer tipke Ø6 mm
- priložen zamjenjivi osigurač

DIMMER ROTATIVE 2WAY RL 400W

- rotation control with 2-way switch
- load RL, 40W - 400W
- 2-way switch combination is possible
- more dimmers combination is not allowed
- in accordance with EN 60669-1 and EN 60669-2-1
- plug-in contacts 1.5mm²
- supply 230V~ 50Hz
- button inner diameter Ø6mm
- replaceable fuse included

REGULATOR OSVJETLJENJA ROTACIJSKI IZMJENIČNI RLC 400W



EE16

- rotacijski s izmjeničnom sklopkom
- opterećenje RLC, 20W – 400W
- moguća je kombinacija s izmjeničnom sklopkom
- povezivanje više regulatora osvjetljenja nije dopušteno
- sukladno normama EN 60669-1 i EN 60669-2-1
- bezvijčani kontakti 1,5mm²
- unutarnji promjer tipke Ø6 mm
- napajanje 230V ~ 50Hz
- elektronski osigurač

DIMMER ROTATIVE 2WAY RLC 400W

- rotation control with 2-way switch
- load RLC, 20W - 400W
- 2-way switch combination is possible
- more dimmers combination is not allowed
- in accordance with EN 60669-1 and EN 60669-2-1
- plug-in contacts 1.5mm²
- button inner diameter Ø6mm
- supply 230V~ 50Hz
- electronic fuse

REGULATOR OSVJETLJENJA ROTACIJSKI VENTILATOR 600VA



EE17

- rotacijski sa sklopkom
- tip 456; opterećenje: motor, 25VA – 600VA
- nije moguća kombinacija s izmjeničnom sklopkom
- povezivanje više regulatora osvjetljenja nije dopušteno
- sukladno normama EN 60669-1 i EN 60669-2-1
- bezvijačni kontakti 1,5mm²
- napajanje 230V ~ 50Hz
- unutarnji promjer tipke Ø4 mm
- priložen zamjenjivi osigurač

DIMMER ROTATIVE FAN 600VA

- rotation control with switch
- type 456; load: motor, 25VA - 600VA
- 2-way switch combination is not possible
- more dimmers combination is not allowed
- in accordance with EN 60669-1 and EN 60669-2-1
- plug-in contacts 1.5mm²
- supply 230V~ 50Hz
- button inner diameter Ø4mm
- replaceable fuse included

REGULATOR OSVJETLJENJA ROTACIJSKI IZMJENIČNI LED 100W



EE19

- rotacijski s izmjeničnom sklopkom
- opterećenje: LED, 0-100W (maks. 10 LED)
- GLS, 10-250W
- moguća je kombinacija s izmjeničnom sklopkom
- povezivanje više regulatora osvjetljenja nije dopušteno
- sukladno normama EN 60669-1 i EN 60669-2-1
- bezvijačni kontakti 1,5mm²
- napajanje 230V ~ 50Hz
- priložen zamjenjivi osigurač
- unutarnji promjer tipke Ø6 mm

DIMMER ROTATIVE 2WAY LED 100W

- rotation control with 2-way switch
- load: LED, 0-100W (max. 10 LEDs)
- GLS, 10-250W
- 2-way switch combination is possible
- more dimmers combination is not allowed
- in accordance with EN 60669-1 and EN 60669-2-1
- plug-in contacts 1.5mm²
- supply 230V~ 50Hz
- replaceable fuse included
- button inner diameter Ø6mm

IR SKLOPKA 5A 250V~



□ EE32

- IR infracrvena sklopka
- napajanje: 230V~ ± 10% 50Hz
- relej: 5A / 250V~ izlaz za ograničeni strujni tok s velikim otporom za prolaz kroz ništicu („zero crossing“)
- zaštitna razina: IP40
- presjek žica na kontaktnom terminalu: 0,75 - 2,5 mm²
- kut prepoznavanja: do 110° pri 20 °C
- raspon prepoznavanja: približno 8m pri 20 °C
- prilagodljivost trajanja: od približno 5 s do 12 min
- prilagodljivost osvjetljenja: od približno 5 do 200 LUX
- temperatura radnog okruženja: od 0 °C do +40 °C
- nije prikladno za ugradnju u kutije duboke 45 mm
- samo za unutrašnju uporabu

IR SWITCH 5A 250V~

- IR infrared switch
- supply voltage: 230V~ ±10 % 50Hz
- relay: 5A / 250V~ output for limited current with high resistance for zero crossing
- protection rating: IP40
- cross-section of wires at the contact terminal: 0.75 - 2.5 mm²
- detection angle: up to 110° at 20°C
- detection area: approx. 8 m at 20°C
- adjustability of duration: from approx. 5 s to 12 min
- adjustability of brightness: from approx. 5 to 200 LUX
- operating temperature: from 0°C to +40°C
- not suitable for installation in 45 mm deep boxes
- only for indoor usage

REGULATOR OSVJETLJENJA ROTACIJSKI IZMJENIČNI RL 400W



□ EE15PW
 ■ EE15IW
 ■ EE15ES
 □ EE15CO
 ■ EE15NB

- rotacijski s izmjeničnom sklopkom
- opterećenje RL, 40W – 400W
- moguća je kombinacija s izmjeničnom sklopkom
- povezivanje više regulatora osvjetljenja nije dopušteno
- sukladno normama EN 60669-1 i EN 60669-2-1
- bezvijačni kontakti 1,5mm²
- napajanje 230V ~ 50Hz
- priložen zamjenjivi osigurač

DIMMER ROTATIVE 2WAY RL 400W

- rotation control with 2-way switch
- load RL, 40W - 400W
- 2-way switch combination is possible
- more dimmers combination is not allowed
- in accordance with EN 60669-1 and EN 60669-2-1
- plug-in contacts 1.5mm²
- supply 230V~ 50Hz
- replaceable fuse included





- EE16PW
- EE16IW
- EE16ES
- EE16CO
- EE16NB

REGULATOR OSVJETLJENJA ROTACIJSKI IZMJENIČNI RLC 400W

- rotacijski s izmjeničnom sklopkom
- opterećenje RLC, 20W – 400W
- moguća je kombinacija s izmjeničnom sklopkom
- povezivanje više regulatora osvjetljenja nije dopušteno
- sukladno normama EN 60669-1 i EN 60669-2-1
- bezvijačni kontakti 1,5mm²
- napajanje 230V ~ 50Hz
- elektronski osigurač



DIMMER ROTATIVE 2WAY RLC 400W

- rotation control with 2-way switch
- load RLC, 20W - 400W
- 2-way switch combination is possible
- more dimmers combination is not allowed
- in accordance with EN 60669-1 and EN 60669-2-1
- plug-in contacts 1.5mm²
- supply 230V~ 50Hz
- electronic fuse



- EE19PW
- EE19IW
- EE19ES
- EE19CO
- EE19NB

REGULATOR OSVJETLJENJA ROTACIJSKI IZMJENIČNI LED 100W

- rotacijski s izmjeničnom sklopkom
- opterećenje: LED, 0-100W (maks. 10 LED)
GLS, 10-250W
- moguća je kombinacija s izmjeničnom sklopkom
- povezivanje više regulatora osvjetljenja nije dopušteno
- sukladno normama EN 60669-1 i EN 60669-2-1
- bezvijačni kontakti 1,5mm²
- napajanje 230V ~ 50Hz
- priložen zamjenjivi osigurač



DIMMER ROTATIVE 2WAY LED 100W

- rotation control with 2-way switch
- load: LED, 0-100W (max. 10 LEDs)
GLS, 10-250W
- 2-way switch combination is possible
- more dimmers combination is not allowed
- in accordance with EN 60669-1 and EN 60669-2-1
- plug-in contacts 1.5mm²
- supply 230V~ 50Hz
- replaceable fuse included



- EE32PW
- EE32IW
- EE32ES
- EE32CO
- EE32NB

IR SKLOPKA 5A 230V~

- IR infracrvena sklopka
- napajanje: 230V ~ ± 10% 50Hz
- relej: 5A / 250V~ izlaz za ograničeni strujni tok s velikim otporom za prolaz kroz ničisticu („zero crossing“)
- zaštitna razina: IP40
- presjek žica na kontaktnom terminalu: 0,75 - 2,5 mm²
- kut prepoznavanja: do 110° pri 20 °C
- raspon prepoznavanja: približno 8m pri 20 °C
- prilagodljivost trajanja: od približno 5 s do 12 min
- prilagodljivost osvjetljenja: od približno 5 do 200 LUX
- temperatura radnog okruženja: od 0 °C do +40 °C
- nije prikladno za ugradnju u kutije duboke 45 mm
- samo za unutrašnju uporabu



IR SWITCH 5A 230V~

- IR infrared switch
- supply voltage: 230V~ ± 10 % 50Hz
- relay: 5A / 250V~ output for limited current with high resistance for zero crossing
- protection rating: IP40
- cross-section of wires at the contact terminal: 0.75 - 2.5 mm²
- detection angle: up to 110° at 20°C
- detection area: approx. 8 m at 20°C
- adjustability of duration: from approx. 5 s to 12 min
- adjustability of brightness: from approx. 5 to 200 LUX
- operating temperature: from 0°C to +40°C
- not suitable for installation in 45 mm deep boxes
- only for indoor usage

EE15, EE16, EE19

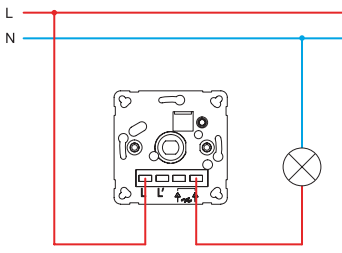

EE15, EE16, EE19

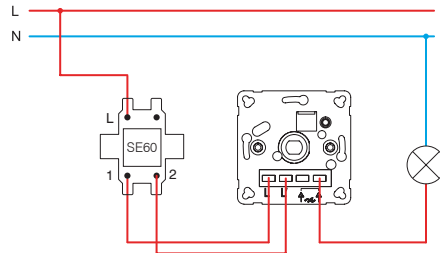

EE15, EE16, EE19

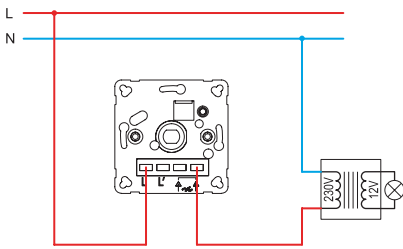

EE15, EE16, EE19

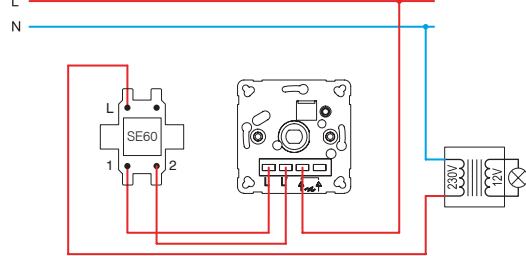

EE16, EE19

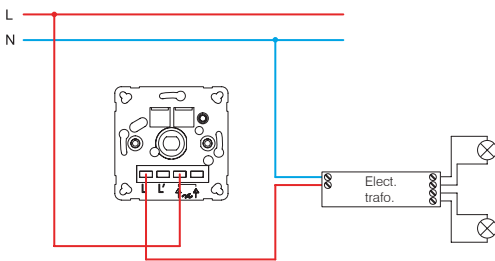

EE16, EE19

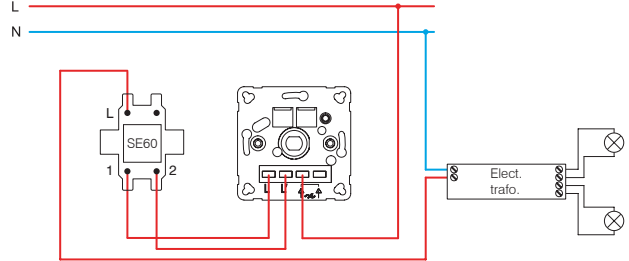

EE17

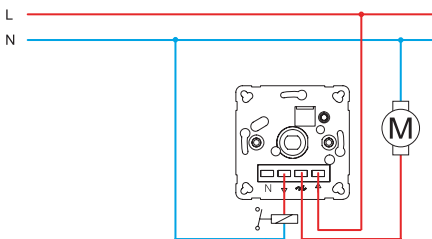

EE15 (40÷400W)

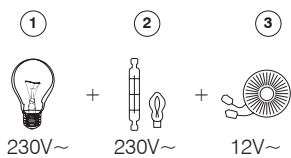

- 1 - žarulja sa žarnom niti / incandescent lamp
- 2 - halogena žarulja / halogen lamp

EE16 (20÷400W)

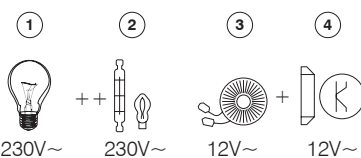

- 3 - klasični transformator / classical transformer
- 4 - elektronički transformator / electronic transformer

EE19 (GLS 10÷250W ; LED 0÷100W)

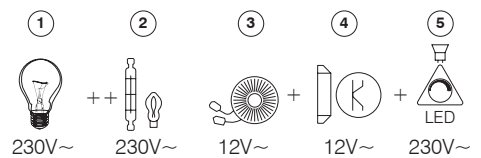

- 5 - LED tinjalica s regulacijom osvijetljenja / dimmable LED lamp

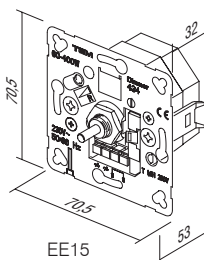

EE15
EE16
EE17
EE19

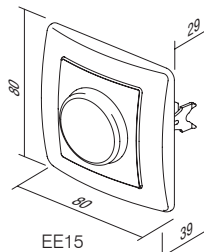

EE15
EE16
EE19

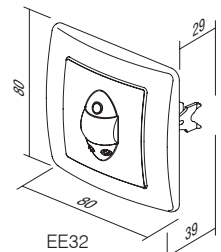

EE32

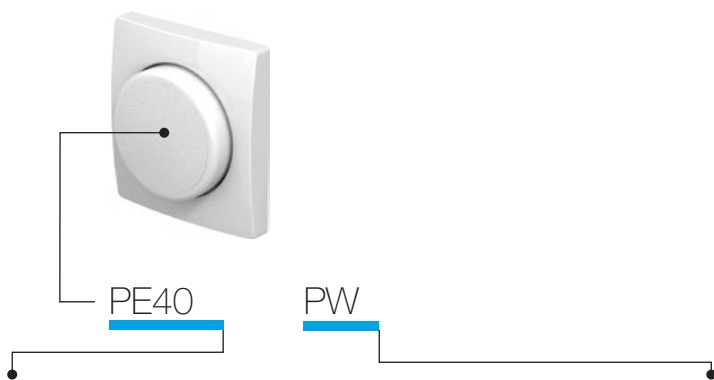

tip type	naziv description	boja colour
PE40	POKLOPAC REGULATORA OSVJETLJENJA COVER DIMMER	<input type="checkbox"/> PW bijela sjajna <i>polar white</i> <input type="checkbox"/> IW bež sjajna <i>ivory white</i> <input type="checkbox"/> ES srebrna mat <i>elox silver</i> <input type="checkbox"/> CO bijeli duroplast <i>white thermoset</i> <input type="checkbox"/> NB crna sjajna <i>night black</i>

POKLOPAC REGULATORA OSVJETLJENJA Ø4



- PE40PW
- PE40IW
- PE40ES
- PE40CO
- PE40NB

- poklopac regulatora osvjetljenja Ø4 mm
- za EE17

COVER DIMMER Ø4
- cover dimmer Ø4mm
- for EE17



POKLOPAC REGULATORA OSVJETLJENJA Ø6



- PE41PW
- PE41IW
- PE41ES
- PE41CO
- PE41NB

- poklopac regulatora osvjetljenja Ø6 mm
- za EE15, EE16, EE19

COVER DIMMER Ø6
- cover dimmer Ø6mm
- for EE15, EE16, EE19



POKLOPAC ZA IR SKLOPKU



- PE32PW
- PE32IW
- PE32ES
- PE32NB

- poklopac za IR sklopku

COVER IR SWITCH
- cover for IR switch

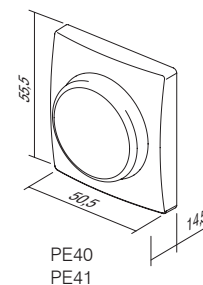

P R I B O R A E

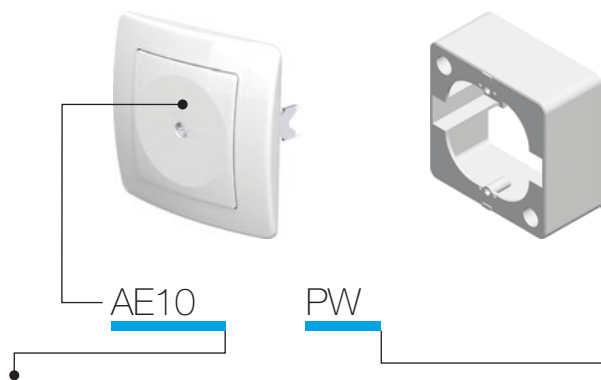

tip type	naziv description	boja colour
AE10	SLIJEPI ELEMENT BLANK	<input type="checkbox"/> PW bijela sjajna polar white
AE20	PRIKLJUČNA KUTIJA 3P + N + E 5X4mm ² CONNECTION BOX 3P+N+E 5X4mm ²	<input type="checkbox"/> IW bež sjajna ivory white
AE30	NADŽBUKNA KUTIJA SURFACE MOUNT BOX	<input type="checkbox"/> ES srebrna mat elox silver
⋮	⋮	<input type="checkbox"/> CO bijeli duroplast white thermoset
⋮	⋮	<input type="checkbox"/> NB crna sjajna night black

SLIJEPI ELEMENT



- AE10PW
- AE10IW
- AE10ES
- AE10CO
- AE10NB

- za pokrivanje praznog prostora

BLANK

- for filling up empty spaces

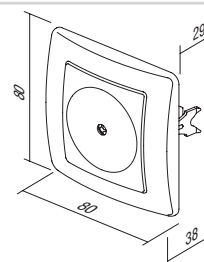
PRIKLJUČNA KUTIJA 5-POLNA 3P + N + E 5x4mm²

- AE20PW
- AE20IW

- priključna kutija 3P+N+E

- 16A 400V ~

- sukladno normi VDE 0606-1:2000

- vijčano pričvršćivanje vodiča presjeka 1,5-4mm²CONNECTION BOX 5POLE 3P+N+E 5x4mm²

- 3P+N+E connection box

- 16A 400V~

- in accordance with VDE 0606-1:2000

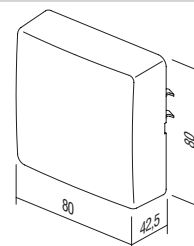
- screw contacts 1.5-4mm²

NADŽBUKNO KUTIJA 1

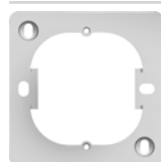

- AE30PW
- AE30IW

- nadžbukna kutija

SURFACE MOUNT BOX 1

- surface mounting box

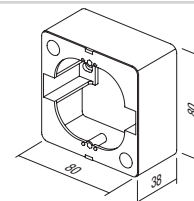



- AE50PW
- AE50TS

ZIDNI ŠTITNIK

- štiti površinu oko utičnice ili sklopke

WALL PROTECTION

- protects surface around socket or switch

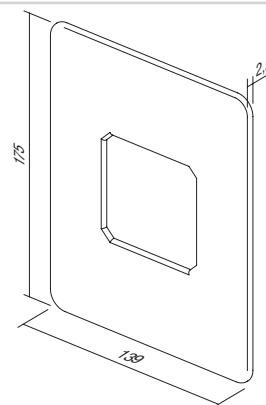

- AE51PW
- AE51IW

ZAŠTITA ZA DJECU KS

- KS dodatna zaštita za djecu od dodira kontakta

CHILD PROTECTION KS

- KS additional child protection insert - shuttered live contacts

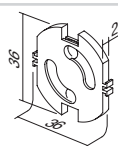

O K V I R I O E

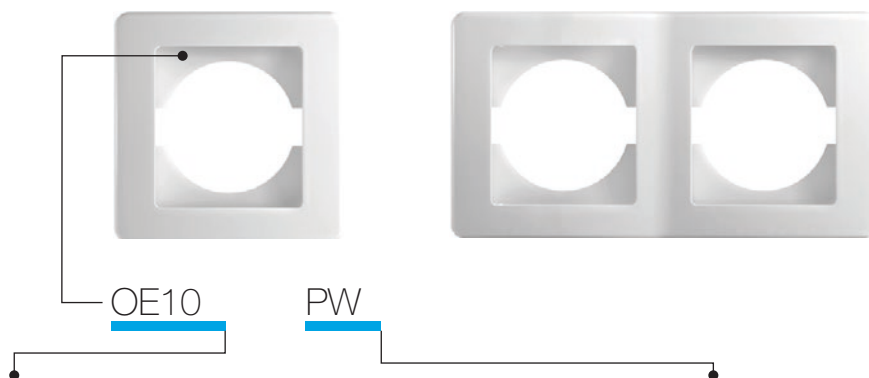

tip type	naziv description	boja colour
OE10	OKVIR EKONOMIK 1 SURROUND EKONOMIK 1	<input type="checkbox"/> PW bijela sjajna polar white
OE20	OKVIR EKONOMIK 2 VODORAVNI SURROUND EKONOMIK 2 HORIZONTAL	<input type="checkbox"/> IW bež sjajna ivory white
OE30	OKVIR EKONOMIK 3 VODORAVNI SURROUND EKONOMIK 3 HORIZONTAL	<input type="checkbox"/> ES srebrna mat elox silver
⋮	⋮	<input type="checkbox"/> CO bijeli duroplast white thermoset
⋮	⋮	<input type="checkbox"/> NB crna sjajna night black

OKVIR EKONOMIK 1



- OE10PW
- OE10IW
- OE10ES
- OE10CO
- OE10NB

- dekorativni pojedinačni okvir
- sukladno normi EN 60669-1

SURROUND EKONOMIK 1

- decorative surround 1-gang
- in accordance with EN 60669-1

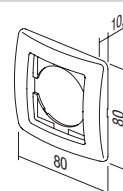

OKVIR EKONOMIK 2 VODORAVNI



- OE20PW
- OE20IW
- OE20ES
- OE20CO
- OE20NB

- dekorativni dvostruki okvir vodoravni
- sukladno normi EN 60669-1

SURROUND EKONOMIK 2 HORIZONTAL

- decorative surround 2-gang horizontal
- in accordance with EN 60669-1

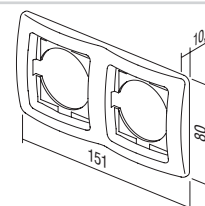

OKVIR EKONOMIK 2 OKOMITI



- OE21PW
- OE21IW
- OE21ES
- OE21CO
- OE21NB

- dekorativni dvostruki okvir okomiti
- sukladno normi EN 60669-1

SURROUND EKONOMIK 2 VERTICAL

- decorative surround 2-gang vertical
- in accordance with EN 60669-1

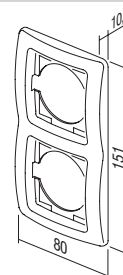

OKVIR EKONOMIK 3 VODORAVNI



- OE30PW
- OE30IW
- OE30ES
- OE30CO
- OE30NB

- dekorativni trostruki okvir vodoravni
- sukladno normi EN 60669-1

SURROUND EKONOMIK 3 HORIZONTAL

- decorative surround 3-gang horizontal
- in accordance with EN 60669-1

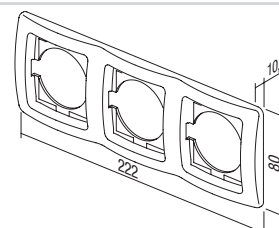



- OE31PW
- OE31IW
- OE31ES
- OE31CO
- OE31NB

OKVIR EKONOMIK 3 OKOMITI

- dekorativni trostruki okvir okomiti
- sukladno normi EN 60669-1

SURROUND EKONOMIK 3 VERTICAL

- decorative surround 3-gang vertical
- in accordance with EN 60669-1

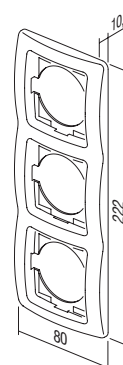

- OE40PW
- OE40IW
- OE40ES
- OE40CO
- OE40NB

OKVIR EKONOMIK 4 VODORAVNI

- dekorativni četverostruki okvir vodoravni
- sukladno normi EN 60669-1

SURROUND EKONOMIK 4 HORIZONTAL

- decorative surround 4-gang horizontal
- in accordance with EN 60669-1

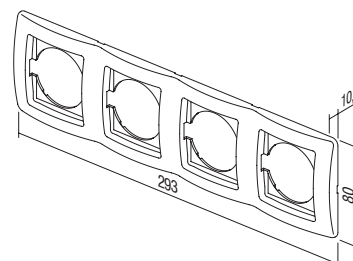

- OE41PW
- OE41IW
- OE41ES
- OE41CO
- OE41NB

OKVIR EKONOMIK 4 OKOMITI

- dekorativni četverostruki okvir okomiti
- sukladno normi EN 60669-1

SURROUND EKONOMIK 4 VERTICAL

- decorative surround 4-gang vertical
- in accordance with EN 60669-1

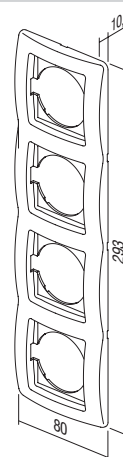

ekonomik

**DEKORATIVNI UMETCI U BOJI /
COLOR DECORATIVE FRAMES**



OE90GR	ZELENI / GREEN	OE90YL	ŽUTI / YELLOW	OE90MB	MET. PLAVI / MET. BLUE
OE90BL	PLAVI / BLUE	OE90WH	BIJELI / WHITE	OE90BZ	BRONČANI / BRONZE
OE90VO	LJUBIČASTI / VIOLET	OE90GY	SIVI / GREY	OE90CR	SREBRNI / SILVER
OE90PI	RUŽIČASTI / PINK	OE90BK	CRNI / BLACK	OE90GO	ZLATNI / GOLD
OE90RD	CRVENI / RED	OE90BR	SMEDI / BROWN		



TEM



KATALOG / CATALOGUE

fontana



SKLOPKE SF
SWITCHES SF



200

UTIČNICE VF
SOCKETS VF



202

SETOVI CF
SETS CF



203

PRIBOR AF
ACCESSORIES AF



205

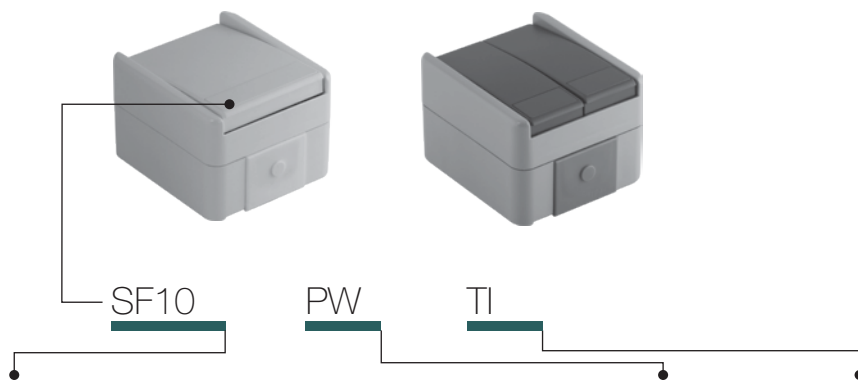

tip type	naziv description	tehnički podaci technical data	boja colour	opcijski podaci 1 optional data 1
SF10	SKLOPKA JEDNOPOLNA SWITCH 1WAY	IP44 10AX 250V~	<input type="checkbox"/> PW bijela mat (RAL 9016) white-mat	TI neonska tinjalica + indikator neon lamp + indication
SF11	TIPKALO JEDNOPOLNO PUSH BUTTON 1WAY	IP44 10A 250V~	<input checked="" type="checkbox"/> GY mat siva grey-mat	
SF20	SKLOPKA DVOPOLNA SWITCH 2POLE	IP44 10AX 250V~		
:	:	:		
:	:	:		

SKLOPKA JEDNOPOLNA IP44 10AX 250V ~



- SF10PW
- SF10GY

- 10AX 250V~, tip SF10
- sukladno normi EN 60669-1
- bezvijčani kontakti 1,5-2,5mm²

SWITCH 1WAY IP44 10AX 250V~

- 10AX 250V~, type SF10
- in accordance with EN 60669-1
- plug-in contacts 1.5-2.5mm²



SKLOPKA JEDNOPOLNA IP44 10AX 250V ~ __ TI



- SF10PWTI
- SF10GYTI

- TI indikator + neonska tinjalica
- 10AX 250V~, tip SF10
- sukladno normi EN 60669-1
- bezvijčani kontakti 1,5-2,5mm²

SWITCH 1WAY IP44 10AX 250V~ __ TI

- TI indikator + neon lamp
- 10AX 250V~, type SF10
- in accordance with EN 60669-1
- plug-in contacts 1.5-2.5mm²



TIPKALO JEDNOPOLNO IP44 10A 250V~ __ TI



- SF11PWTI
- SF11GYTI

- TI indikator + neonska tinjalica
- 10A 250V~, tip SF11
- sukladno normi EN 60669-1
- bezvijčani kontakti 1,5-2,5mm²

PUSH BUTTON 1WAY IP44 10A 250V~ __ TI

- TI indikator + neon lamp
- 10A 250V~, type SF11
- in accordance with EN 60669-1
- plug-in contacts 1.5-2.5mm²



SKLOPKA DVOPOLNA IP44 10AX 250V ~



- SF20PW
- SF20GY

- 10AX 250V~, tip SF20
- sukladno normi EN 60669-1
- bezvijčani kontakti 1,5-2,5mm²

SWITCH 2POLE IP44 10AX 250V~

- 10AX 250V~, type SF20
- in accordance with EN 60669-1
- plug-in contacts 1.5-2.5mm²



SKLOPKA SERIJSKA JEDNOPOLNA IP44 10AX 250V ~



- SF50PW
- SF50GY

- 10AX 250V~, tip SF50
- skladno normi EN 60669-1
- bežvičani kontakti 1,5-2,5mm²

SWITCH 2GANG-1WAY IP44 10AX 250V~

- 10AX 250V~, type SF50
- in accordance with EN 60669-1
- plug-in contacts 1.5-2.5mm²



TIPKALO SERIJSKO JEDNOPOLNO IP44 10A 250V ~



- SF51PW
- SF51GY

- 10A 250V~, tip SF51
- skladno normi EN 60669-1
- bežvičani kontakti 1,5-2,5mm²

PUSH BUTTON 2GANG-1WAY IP44 10A 250V~

- 10A 250V~, type SF51
- in accordance with EN 60669-1
- plug-in contacts 1.5-2.5mm²



SKLOPKA IZMJENIČNA IP44 10AX 250V ~



- SF60PW
- SF60GY

- 10AX 250V~, tip SF60
- skladno normi EN 60669-1
- bežvičani kontakti 1,5-2,5mm²

SWITCH 2WAY IP44 10AX 250V~

- 10AX 250V~, type SF60
- in accordance with EN 60669-1
- plug-in contacts 1.5-2.5mm²



SKLOPKA IZMJENIČNA IP44 10AX 250V ~ __ TI



- SF60PWTI
- SF60GYTI

- TI indikator + neonska tinjalica
- 10AX 250V~, tip SF60
- skladno normi EN 60669-1
- bežvičani kontakti 1,5-2,5mm²

SWITCH 2WAY IP44 10AX 250V~ __ TI

- TI indicator+neon lamp
- 10AX 250V~, type SF60
- in accordance with EN 60669-1
- plug-in contacts 1.5-2.5mm²



SKLOPKA IZMJENIČNA DVOSTRUKA IP44 10AX 250V ~



- SF63PW
- SF63GY

- 10AX 250V~, tip SF63
- skladno normi EN 60669-1
- bežvičani kontakti 1,5-2,5mm²

SWITCH 2WAY DOUBLE IP44 10AX 250V~

- 10AX 250V~, type SF63
- in accordance with EN 60669-1
- plug-in contacts 1.5-2.5mm²



SKLOPKA KRIŽNA IP44 10AX 250V ~



- SF70PW
- SF70GY

- 10AX 250V~, tip SF70
- skladno normi EN 60669-1
- bežvičani kontakti 1,5-2,5mm²

SWITCH INTERMEDIATE IP44 10AX 250V~

- 10AX 250V~, type SF70
- in accordance with EN 60669-1
- plug-in contacts 1.5-2.5mm²

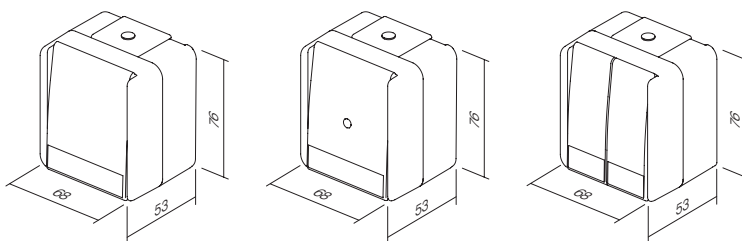

U T I Č N I C E V F S O C K E T S

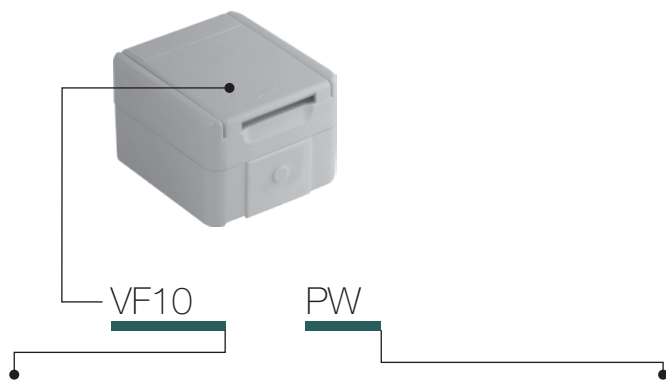

tip type	naziv description	tehnički podaci technical data	boja colour
VF10	ŠUKO UTIČNICA+POKLOPAC SOCKET SCHUKO+COVER	IP44 2P+E 16A 250V~	<input type="checkbox"/> PW bijela mat (RAL 9016) white-mat <input type="checkbox"/> GY mat siva grey-mat

UTIČNICA ŠUKO + POKLOPAC IP44 2P+E 16A 250V ~



- VF10PW
- VF10GY

- vijčano pričvršćivanje vodiča presjeka 1,5-2,5 mm²
- 2P+E šuko+poklopac
- 16A 250V~, tip VF10
- sukladno normama EN 60884-1, CEE7

SOCKET SCHUKO+COVER IP44 2P+E 16A 250V~

- screw contacts 1.5-2.5mm²
- 2P+E schuko+cover
- 16A 250V~, type VF10
- in accordance with EN 60884-1, CEE7



UTIČNICA ŠUKO + POKLOPAC IP44 2P+E 16A 250V ~ BV



- VF12PWTI
- VF12GYTI

- BV bezvijčani kontakti 1,5-2,5mm²
- 2P+E šuko+poklopac
- 16A 250V~, tip VF12
- sukladno normama EN 60884-1, CEE7

SOCKET SCHUKO+COVER IP44 2P+E 16A 250V~ BV

- BV plug-in contacts 1.5-2.5mm²
- 2P+E schuko+cover
- 16A 250V~, type VF12
- in accordance with EN 60884-1, CEE7

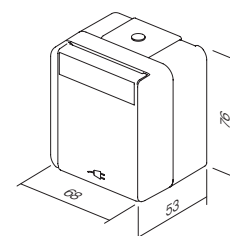

S E T S C F

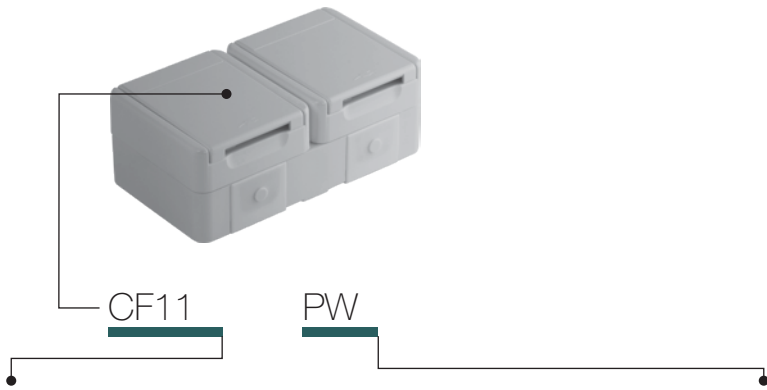

tip type	naziv description	tehnički podaci technical data	boja colour
CF10	SET ŠUKO UTIČNICA DVOSTRUKIH VODORAVNE SOCKET SET SCHUKO DOUBLE HORIZ	2x 2P+E 16A 250V~ IP44	<input type="checkbox"/> PW bijela mat (RAL 9016) white-mat
CF11	SET ŠUKO UTIČNICA DVOSTRUKIH OKOMITE SOCKET SET SCHUKO DOUBLE VERT	2x 2P+E 16A 250V~ IP44	<input checked="" type="checkbox"/> GY mat siva grey-mat
CF12	ŠUKO UTIČNICA + SKLOPKA IZMJENIČNI VODORAVNI SOCKET SCH+SWITCH 2WAY HORIZ	16A + 10A 250V~ IP44	
⋮	⋮	⋮	
⋮	⋮	⋮	



- CF10PW
 CF10GY

SET ŠUKO UTIČNICA, DVOSTRUKI, VODORAVNI IP44 2x 2P+E 16A 250V ~

- vijčano pričvršćivanje vodiča presjeka 1,5-2,5 mm²
- 2x 2P+E šuko + poklopac vodoravni
- 16A 250V~, tip CF10
- sukladno normama EN 60884-1, CEE7

SOCKET SET SCHUKO DOUBLE
HORIZONTAL IP44 2x 2P+E 16A 250V~
- screw contacts 1.5-2.5mm²
- 2x 2P+E schuko+cover horizontal
- 16A 250V~, type CF10
- in accordance with EN 60884-1, CEE7



- CF11PW
 CF11GY

SET ŠUKO UTIČNICA DVOSTRUKI, OKOMITI IP44 2x 2P+E 16A 250V ~

- vijčano pričvršćivanje vodiča presjeka 1,5-2,5 mm²
- 2x 2P+E šuko + poklopac, okomiti set
- 16A 250V~, tip CF11
- sukladno normama EN 60884-1, CEE7

SOCKET SET SCHUKO DOUBLE VERTICAL
IP44 2x 2P+E 16A 250V~
- screw contacts 1.5-2.5mm²
- 2x 2P+E schuko+cover vertical
- 16A 250V~, type CF11
- in accordance with EN 60884-1, CEE7



- CF12PW
 CF12GY

SET ŠUKO UTIČNICA + SKLOPKA IZMJENIČNA, VODORAVNI IP44 16A + 10AX 250V ~

- vijčano (priključnica), bezvijčano (sklopka) pričvršćivanje vodiča presjeka 1,5-2,5mm²
- 2P+E šuko+poklopac + sklopka izmjenična vodoravna
- 16A + 10AX 250V~, tip CF12
- sukladno normama EN 60884-1, CEE7, EN 60669-1

SOCKET SCH+SWITCH SET 2WAY
HORIZONTAL IP44 16A + 10AX 250V~
- screw (socket), plug-in (switch)
contacts 1.5-2.5mm²
- 2P+E schuko+cover + switch 2-way horizontal
- 16A + 10AX 250V~, type CF12
- in accordance with EN 60884-1, CEE7, EN 60669-1

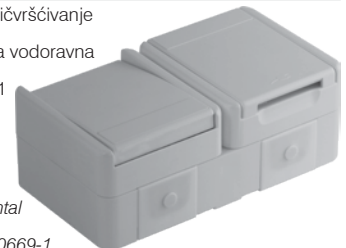

SET ŠUKO UTIČNICA + SKLOPKA IZMJENIČNA, OKOMITI, IP44 16A + 10AX 250V~



- CF13PW
- CF13GY

- vijčano (priključnica), bezvijčano (sklopka)
- pričvršćivanje vodiča presjeka 1,5-2,5mm²
- 2P+E šuko+poklopac + sklopka izmjenična okomita
- 16A + 10AX 250V ~, tip CF13
- sukladno normama EN 60884-1, CEE7, EN 60669-1

SOCKET SCH+SWITCH 2WAY SET VERTICAL IP44 16A + 10AX 250V~

- screw (socket), plug-in (switch)
- contacts 1.5-2.5mm²
- 2P+E schuko+cover + switch 2-way vertical
- 16A + 10AX 250V~, type CF13
- in accordance with EN 60884-1, CEE7, EN 60669-1



SET ŠUKO UTIČNICA DVOSTRUKI, VODORAVNI, IP44 2X 2P+E 16A 250V ~ BV



- CF14PW
- CF14GY

- BV bezvijčani kontakti 1,5-2,5mm²
- 2x 2P+E šuko + poklopac vodoravni
- 16A 250V~, tip CF14
- sukladno normama EN 60884-1, CEE7

SOCKET SET SCHUKO DOUBLE HORIZONTAL IP44 2x 2P+E 16A 250V~ BV

- BV plug-in contacts 1.5-2.5mm²
- 2x 2P+E schuko+cover horizontal
- 16A 250V~, type CF14
- in accordance with EN 60884-1, CEE7



SET ŠUKO UTIČNICA DVOSTRUKI, OKOMITI, IP44 2X 2P+E 16A 250V ~ BV



- CF15PW
- CF15GY

- BV bezvijčani kontakti 1,5-2,5mm²
- 2x 2P+E šuko + poklopac, okomiti set
- 16A 250V~, tip CF15
- sukladno normama EN 60884-1, CEE7

SOCKET SET SCHUKO DOUBLE VERTICAL IP44 2x 2P+E 16A 250V~ BV

- BV plug-in contacts 1.5-2.5mm²
- 2x 2P+E schuko+cover vertical
- 16A 250V~, type CF15
- in accordance with EN 60884-1, CEE7



SET UTIČNICA + SKLOPKA IZMJENIČNA, VODORAVNI, IP44 16A + 10AX 250V ~ BV



- CF16PW
- CF16GY

- BV bezvijčani kontakti 1,5-2,5mm²
- 2P+E šuko+poklopac + sklopka izmjenična vodoravna
- 16A + 10AX 250V ~, tip CF16
- sukladno normama EN 60884-1, CEE7, EN 60669-1

SOCKET+SWITCH SET SCH+2WAY HORIZONTAL IP44 16A + 10AX 250V~ BV

- BV plug-in contacts 1.5-2.5mm²
- 2P+E schuko+cover + switch 2-way horizontal
- 16A + 10AX 250V~, type CF16
- in accordance with EN 60884-1, CEE7, EN 60669-1



SET UTIČNICA + SKLOPKA IZMJENIČNA, OKOMITI, IP44 16A + 10AX 250V ~ BV



- CF17PW
- CF17GY

- BV bezvijčani kontakti 1,5-2,5mm²
- 2P+E šuko+poklopac + sklopka izmjenična okomita
- 16A + 10AX 250V ~, tip CF17
- sukladno normama EN 60884-1, CEE7, EN 60669-1

SOCKET SCH+SWITCH 2WAY SET VERTICAL IP44 16A + 10AX 250V~ BV

- BV plug-in contacts 1.5-2.5mm²
- 2P+E schuko+cover + switch 2-way vertical
- 16A + 10AX 250V~, type CF17
- in accordance with EN 60884-1, CEE7, EN 60669-1



P R I B O R A F A C C E S S O R I E S

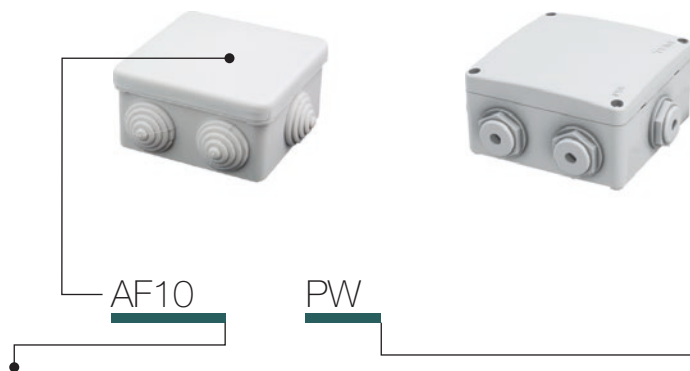

tip type	naziv description	tehnički podaci technical data	boja colour
AF10	RAZDJELNI ORMARIĆ DISTRIBUTION BOX	IP44 RN01	<input type="checkbox"/> PW bijela mat (RAL 9016) white-mat
AF20	RAZDJELNI ORMARIĆ DISTRIBUTION BOX	IP55 NDO1	<input type="checkbox"/> GY mat siva grey-mat

RAZDJELNI ORMARIĆ IP44 RN01



- AF10PW
- AF10GY

- nadžbukni razdjelni ormarić IP44
- 16A 400V ~
- sukladno normi EN 60309-1

DISTRIBUTION BOX IP44 RN01

- surface mounting distribution box IP44
- 16A 400V ~
- in accordance with EN 60309-1

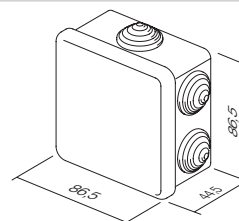

RAZDJELNI ORMARIĆ IP55 ND01



- AF20PW
- AF20GY

- nadžbukna priključna kutija IP55
- brtve uključene
- sukladno normi EN 60309-1

DISTRIBUTION BOX IP55 ND01

- surface mounting connection box IP55
- glands included
- in accordance with EN 60309-1

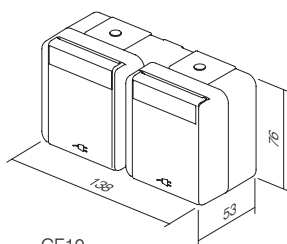
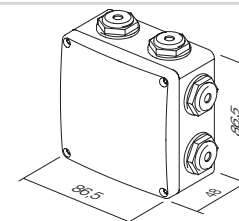

CF10
CF14

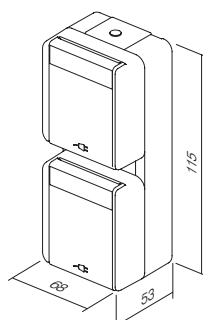

CF11
CF15

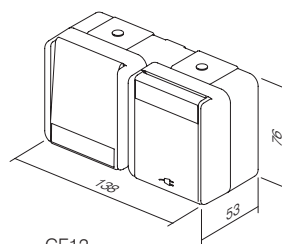

CF12
CF16

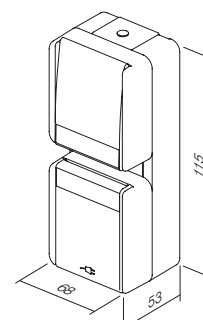

CF13
CF17

MODUL

šifra	opis proizvoda	stranica	šifra	opis proizvoda	stranica
PREKIDAČI SM			KOMUNIKACIJSKI PRIBOR KA		
SM10	PREKIDAČ JEDNOPOLNI 16AX 250V~ 1M	58	KA10	KONEKTOR KS CAT3 RJ11 6/4	78
SM11	TIPKALO JEDNOPOLNO 16A 250V~ 1M	58	KA11	KONEKTOR KS CAT5e RJ45 8/8	78
SM12	PREKIDAČ JEDNOPOLNI 16AX 250V~ 1M	58	KA12	KONEKTOR KS CAT5eS RJ45 8/8	78
SM20	PREKIDAČ DVOPOLNI 16AX 250V~ 1M	58	KA15	KONEKTOR KS CAT6 SCHRACK RJ45 8/8	78
SM40	PREKIDAČ ZA ŽALUZINE 16AX 250V~ 1M	59	KA16	KONEKTOR KS CAT6S SCHRACK RJ45 8/8	78
SM41	TIPKALO ZA ŽALUZINE 16A 250V~ 1M	59	KA17	KONEKTOR KS CAT6a SCHRACK RJ45 8/8	78
SM60	PREKIDAČ IZMJENIČNI 16AX 250V~ 1M	59	KA27	KONEKTOR KS HDMI	79
SM61	TIPKALO IZMJENIČNO 16A 250V~ 1M	59	ELEKTRONIKA EM		
SM70	PREKIDAČ KRIŽNI 16AX 250V~ 1M	59	EM10--	DIMER ROTACIJSKI RL 300W 1M	80
SM10--	PREKIDAČ JEDNOPOLNI 16AX 250V~ 1M	60	EM11--	DIMER ROT/IZMJENIČNI RL 300W 1M	80
SM10--IN	PREKIDAČ JEDNOPOLNI 16AX 250V~ 1M IN	60	EM21	DIMER UGRADBENI RLC 300W	81
SM11--	TIPKALO JEDNOPOLNO 16A 250V~ 1M	60	EM22	DIMER UGRADBENI R 500W	81
SM11--IN01	TIPKALO JEDNOPOLNO 16A 250V~ 1M IN 01	60	EM25--	DIMER UNIVEZALNI RLC 0-300W 2M	82
SM11--IN02	TIPKALO JEDNOPOLNO 16A 250V~ 1M IN 02	61	EM26--	TIPKALO ZA UPRAVLJANJE 2M	84
SM20--NT03	PREKIDAČ DVOPOLNI 16AX 250V~ 1M NT 03	61	EM27	MREŽNI FILTER PROTIV SMETNJI	84
SM20--IN	PREKIDAČ DVOPOLNI 16AX 250V~ 1M IN	61	EM25PPOL20	SET PREKIDAČ/DIMER UNIVERZALNI RLC 0-300W 2M PP OL20	84
SM40--NT10	PREKIDAČ ZA ŽALUZINE 1-0-2 16AX 250V~ 1M NT 10	61	EM31--	IR PREKIDAČ 5A 250V~ 1M	85
SM41--NT10	TIPKALO ZA ŽALUZINE 1-0-2 16A 250V~ 1M NT 10	61	EM32--	IR PREKIDAČ 5A 250V~ 2M	85
SM60--	PREKIDAČ IZMJENIČNI 16AX 250V~ 1M	61	EM37--	TERMOSTAT OSNOVNI 6A 250V~ 2M	87
SM61--	TIPKALO IZMJENIČNO 16A 250V~ 1M	62	EM40--	KARTIČNA SKLOPKA OSNOVNA 3A 250V~ 3M	88
SM62--CD	TIPKALO IZMJENIČNO S UZICOM 16A 250V~ 1M CD	62	EM47	KARTIČA ISO BAR KOD	88
SM70--	PREKIDAČ KRIŽNI 16AX 250V~ 1M	62	EM44--	KARTIČNA SKLOPKA ZA UŠTEDU ENERGIJE 3M	89
TIPKE TM			EM49	RELEJSKA JEDINICA ZA KARTIČNU SKLOPKU 2x16A 250V~	89
TM11--	TIPKA 1M	63	EM45	RAZDJELENIK SPL-1	89
TM11--IN	TIPKA 1M IN	63	EM60--	UTIČNICA ZA BRIJAČI APARAT 2,5A 230V~/15A 110V~ 3M	90
TM12--	TIPKA 2M	63	EM65--	PUNJAČ USB 5V 1A 2M	90
TM12--IN	TIPKA 2M IN	63	EM55	LED SVJETILJKA ZA SLUČAJ NUŽDE 250V~ 1,5 W, NiMH 6h 7M	90
TM13--IL	TIPKA S NATPISNOM PLOČICOM 2M	64	EM50--	SVJETILJKA LED JEDNOBOJNA 250V~ 12W 2M	91
TM15--	TIPKA 1M DVOPOLNA	64	EM51--	SVJETILJKA LED DVOBOJNA 250V~ 2x6W 2M	91
TM21--	PUNILO 1M	64	EM52--	SVJETILJKA LED 3D DVOBOJNA 230V~ 2x6W 2M	91
TM22--	PUNILO 2M	64	EM70--	PREKIDAČ NA OTISAK PRSTA ARX1, 3A/12V 2M	92
TM31--	UVODNICA 1M	64	EM80--	PREKIDAČ BEZDODIRNI 10A 240V~	93
INDIKACIJA IA			EM81--	PREKIDAČ BEZDODIRNI ZA UPRAVLJANJE	93
IA10--	TINJALICA 220V~ 0,25W	66	EM90--	ZUJALICA 8VA 220V~ 1M	94
IA20--	SIJALICA LED 220V~ 4W	66	EM91--	ZUJALICA 8VA 12V 1M	94
IA21--	SIJALICA LED 24V AC/DC 0,5W	66	EM92--	ZVONO 8VA 220V~ 1M	94
IA22--	SIJALICA LED 12V AC/DC 0,25W	66	EM93--	ZVONO 8VA 12V 1M	94
UTIČNICE VM			EM95--	REGULATOR GLASNOĆE ZA 100V AUDIO LINIJU 35W 2M	95
VM10--	UTIČNICA SCHUKO+KS 2P+E 16A 250V~ 2M	68	EM96--	REGULATOR GLASNOĆE NISKOOHMSKI 4-8 Ω 35W 2M	95
VM11--	UTIČNICA SCHUKO+KS+POKLOPAC 2P+E 16A 250V~ 2M	68	SETOVI CM		
VM20--	UTIČNICA EURO+KS 2P 10A 250V~ 1M	69	CM10--	SET UTIČNICA 2x SCHUKO 2P+E 16A 250V~ 4M	96
VM40--	UTIČNICA FRANCUSKA+KS 2P+E 16A 250V~ 2M	69	CM11--	SET UTIČNICA 3x SCHUKO 2P+E 16A 250V~ 7M	96
VM41--	UTIČNICA FRANCUSKA+KS+POKLOPAC 2P+E 16A 250V~ 2M	69	CM15	SET SPOJNICA RAZNOBOJNI 3x1,5mm ² 1M	97
VM30--	UTIČNICA TALJANSKA P17/11+KS 2P+E 16A 250V~ 1M	69	CM16	SET SPOJNICA RAZNOBOJNI 3x2,5mm ² 2M	97
VM31--	UTIČNICA SCHUKO/ITA P17/11+KS 2P+E 16A 250V~ 2M	69	CM17	SET VIJAKA 3,5x20	97
VM32--	UTIČNICA SCHUKO/ITA P30+KS 2P+E 16A 250V~ 2M	70	CM18	SET VIJAKA 3,5x35	97
VM33--	UTIČNICA TALJANSKA P11+KS 2P+E 10A 250V~ 1M	70	CM19	SET VIJAKA 3,5x50	97
VM21--	UTIČNICA EURO/AMERIČKA+KS 2P 16A 250V~ 1M	70	CM22--	SET ZA PREKIDAČE IP44 2M	97
VM51--	UTIČNICA BRITANSKA BS546+KS 2P+E 15A 250V~ 2M	70	CM23--	SET ZA UTIČNICE IP44 2M	97
VM52--	UTIČNICA BRITANSKA BS 1363+KS 2P+E 13A 250V~ 2M	70	CM25--OL	SET ZA KUPAONICU 3x20AX 250V~ 4M OL	97
VM80	PRENAPONSKA ZAŠTITA MPE MINI 275V/50Hz	70	CM25--OS	SET ZA KUPAONICU 3x20AX 250V~ 4M OS	97
KOMUNIKACIJE KM			NM41	NOSAČ SET ZA KUPAONICU 4M	98
KM10--	UTIČNICA TV OSNOVNA 0dB 1M	72	OL41--	OKVIR LINE SET ZA KUPAONICU	98
KM20--	UTIČNICA TV OSNOVNA 0dB 2M	72	OS41--	OKVIR SOFT SET ZA KUPAONICU	98
KM11--	UTIČNICA TV ZAVRŠNA 1dB 1M	72	ANTIBAKTERIJSKI PROGRAM AW		
KM12--	UTIČNICA TV PRIJELAZNA 10dB 1M	72	TM11AW	TIPKA 1M	101
KM15--	UTIČNICA SAT OSNOVNA 0dB 1M	73	TM11AWIN	TIPKA 1M IN	101
KM24--	UTIČNICA SAT OSNOVNA 0dB 2M	73	TM12AW	TIPKA 2M	101
KM16--	UTIČNICA SAT ZAVRŠNA 1dB 1M	73	TM12AWIN	TIPKA 2M IN	101
KM19--	UTIČNICA R OSNOVNA 0dB 1M	73	TM21AW	PUNILO 1M	101
KM29--	UTIČNICA R OSNOVNA 0dB 2M	73	TM22AW	PUNILO 2M	101
KM25--	UTIČNICA SAT-TV ZAVRŠNA 1dB 2M	73	VM10AW	UTIČNICA SCHUKO+KS 2P+E 16A 250V~ 2M	102
KM22--	UTIČNICA AUDIO 2xRCA 1M	74	VM11AW	UTIČNICA SCHUKO+KS+POKLOPAC 2P+E 16A 250V~ 2M	102
KM23--	UTIČNICA AUDIO ZA ZVUČNIKE 1M	74	VM20AW	UTIČNICA EURO+KS 2P 10A 250V~ 1M	102
KM26--	UTIČNICA AUDIO ZA ZVUČNIKE 2M	74	KM11AW	UTIČNICA TV ZAVRŠNA 1dB 1M	102
KM30--	UTIČNICA TEL LT RJ11 8/4 1M	75	KM35AW	ADAPTER KS 1M	102
KM31--	UTIČNICA TEL BT SEC 6/6 1M	75	OS20AW	OKVIR SOFT 2M	103
KM36--	UTIČNICA TEL KS RJ11 6/4 1M	75	OS24AW	OKVIR SOFT 2x2M	103
KM37--	UTIČNICA CAT5e KS RJ45 8/8 1M	75	OS26AW	OKVIR SOFT 3x2M	103
KM35--	ADAPTER KS 1M	75	OS30AW	OKVIR SOFT 3M	103
KM38--	ADAPTER KS SA ZAŠTITOM OD PRAHA 1M	75	OS40AW	OKVIR SOFT 4M	103
KM50--	ADAPTER KS UNIVERZALNI 1M	76	OS70AW	OKVIR SOFT 7M	103
KM40--	ADAPTER PD 1M	76	OKVIRI PURE OP		
KM43--	ADAPTER PD SA ZAŠTITOM OD PRAHA 1M	76	OP20--	OKVIR PURE 2M	106
KM46--	ADAPTER R&M 1M	76	OP24--	OKVIR PURE 2x2M	106
KM47--	ADAPTER R&M SA ZAŠTITOM OD PRAHA 1M	76	OP26--	OKVIR PURE 3x2M	106
KM45--	ADAPTER LK 1M	76	OP30--	OKVIR PURE 3M	107
KA26	ADAPTER NEXSANS 2M	77	OP40--	OKVIR PURE 4M	107
KM48--	ADAPTER AT&T SYSTIMAX SA ZAŠTITOM OD PRAHA 1M	77	OP70--	OKVIR PURE 7M	107
KM51--	UTIČNICA USB TIP A 1M	77	OP13--	OKVIR PURE 1/3M	107
			OP23--	OKVIR PURE 2/3M	107

I N D E X

šifra	opis proizvoda	stranica
OKVIRI LINE OL		
OL20--	OKVIR LINE 2M	110
OL24--	OKVIR LINE 2x2M	110
OL26--	OKVIR LINE 3x2M	110
OL28--	OKVIR LINE 4x2M	110
OL30--	OKVIR LINE 3M	111
OL40--	OKVIR LINE 4M	111
OL70--	OKVIR LINE 7M	111
OL10--	OKVIR LINE 1M	111
OL13--	OKVIR LINE 1/3M	111
OL23--	OKVIR LINE 2/3M	111

šifra	opis proizvoda	stranica
OKVIRI SOFT OS		
OS20--	OKVIR SOFT 2M	114
OS24--	OKVIR SOFT 2x2M	114
OS26--	OKVIR SOFT 3x2M	114
OS28--	OKVIR SOFT 4x2M	114
OS30--	OKVIR SOFT 3M	115
OS40--	OKVIR SOFT 4M	115
OS70--	OKVIR SOFT 7M	115
OS72--	OKVIR SOFT 2x7M	115
OS10--	OKVIR SOFT 1M	115
OS13--	OKVIR SOFT 1/3M	115
OS23--	OKVIR SOFT 2/3M	115

šifra	opis proizvoda	stranica
NOSAČI MM		
NM20	NOSAČ S NOŽICAMA 2M	120
NM21	NOSAČ BEZ VIJAKA 2M	120
NM24	NOSAČ METALNI S NOŽICAMA 2M	120
NM25	NOSAČ METALNI BEZ VIJAKA 2M	120
NM30	NOSAČ S VIJCIMA 3M	121
NM40	NOSAČ S VIJCIMA 4M	121
NM70	NOSAČ S VIJCIMA 7M	121
NM72	NOSAČ S VIJCIMA 2x7M	121
NM10	NOSAČ S NOŽICAMA 1M	122
NM11	NOSAČ BEZ VIJAKA 1M	122
NM23	NOSAČ S NOŽICAMA 2/3M	122
NM32	NOSAČ S VIJCIMA 2/3M	122

KUTIJE

šifra	opis proizvoda	stranica
OKRUGLE KUTIJE		
DE10	KUTIJA OKRUGLA PLITKA ZA ZID SM60-01	126
DE11	KUTIJA OKRUGLA DUBOKA ZA ZID SM60-06	126
DE30	ELEMENT ZA SPAJANJE ZA ZID SM60-03	126
DE31	ELEMENT ZA SPAJANJE ZA ZID SM60-04	126
DE12	KUTIJA OKRUGLA ZA ZID 65-46	127
DE13	KUTIJA OKRUGLA ZA ZID 65-60	127
DE14	PRODUŽETAK KUTIJE ZA ZID 65-46	127
DE32	ELEMENT ZA SPAJANJE ZA ZID 65-71	127
DE33	ELEMENT ZA SPAJANJE ZA ZID 65-91	127
DE20	ZAŠTITNI POKLOPAC KUTIJE 60	127
DE21	ZAŠTITNI POKLOPAC KUTIJE 65	127
DE22	POKLOPAC KUTIJE DEKORATIVNI SM60	127
HE10	KUTIJA OKRUGLA ZA ŠUPLJE STIJENE SM68x40	130
HE11	KUTIJA OKRUGLA ZA ŠUPLJE STIJENE SM68x55	130
BE10	KUTIJA OKRUGLA ZA BETON 60-49	130
BE11	KUTIJA OKRUGLA ZA BETON 60-77	130
BE20	NOSITELJ KUTIJE ZA BETON	130
BE21	UVODNICA KUTIJE ZA BETON 16	130

PRAVOKUTNE KUTIJE

DM30	KUTIJA PRAVOKUTNA ZA ZID PM3	134
DM31	KUTIJA PRAVOKUTNA ZA ZID PM3-65	134
DM40	KUTIJA PRAVOKUTNA ZA ZID PM4	134
DM41	KUTIJA PRAVOKUTNA ZA ZID PM4-65	134
DM70	KUTIJA PRAVOKUTNA ZA ZID PM7	135
DM71	KUTIJA PRAVOKUTNA ZA ZID PM7-65	135
DM72	KUTIJA PRAVOKUTNA ZA ZID PM72-65	135
DM80	ELEMENT ZA SPAJANJE KUTIJE PM	135
DM33	POKLOPAC KUTIJE ZAŠTITNI PM3	136
DM34	POKLOPAC KUTIJE DEKORATIVNI PM3	136
DM43	POKLOPAC KUTIJE ZAŠTITNI PM4	136
DM44	POKLOPAC KUTIJE DEKORATIVNI PM4	136
DM73	POKLOPAC KUTIJE ZAŠTITNI PM7	136
DM74	POKLOPAC KUTIJE DEKORATIVNI PM7	136
DM75	POKLOPAC KUTIJE DEKORATIVNI PM72	137
HM30	KUTIJA PRAVOKUTNA ZA ŠUPLJE STIJENE VM3	138
HM40	KUTIJA PRAVOKUTNA ZA ŠUPLJE STIJENE VM4	138
HM70	KUTIJA PRAVOKUTNA ZA ŠUPLJE STIJENE VM7	138
HM72	KUTIJA PRAVOKUTNA ZA ŠUPLJE STIJENE VM72	138
BM30	KUTIJA PRAVOKUTNA ZA BETON BM3	139
BM40	KUTIJA PRAVOKUTNA ZA BETON BM4	139
BM70	KUTIJA PRAVOKUTNA ZA BETON BM7	139
BM80	VEZNI PROFIL ZA KUTIJE BM	139
BM82	VEZNI PROFIL ZA KUTIJE	139

šifra	opis proizvoda	stranica
RAZVODNE KUTIJE		
DW10	RAZVODNA KUTIJA OKRUGLA ZA ZID DSM78	142
HW10	RAZVODNA KUTIJA OKRUGLA ZA ŠUPLJE STIJENE SM78x45	142
DE23	POKLOPAC KUTIJE DEKORATIVNI SM78	142
DE24	ZAŠTITNI POKLOPAC KUTIJE 78	142
HW20	RAZVODNA KUTIJA KVADRATNA ZA ZID SM105x105	142

PRIBOR ZA OŽIČENJE

UW10--	STEZALJKA JEDNOREDNA PA 2x2,5mm ² 12P	144
UW11--	STEZALJKA JEDNOREDNA PA 2x4mm ² 12P	144
UW12--	STEZALJKA JEDNOREDNA PA 2x6mm ² 12P	144
UW15--	STEZALJKA JEDNOREDNA ZATVORENA PC 2x2,5mm ² 10P	144
UW16--	STEZALJKA JEDNOREDNA ZATVORENA PC 2x4mm ² 10P	144
UW17--	STEZALJKA JEDNOREDNA ZATVORENA PC 2x6mm ² 10P	144
UW20--	STEZALJKA DVOREDNA PA 1,5mm ² 12P	144
UW21--	STEZALJKA DVOREDNA PA 2,5mm ² 12P	144
UW22--	STEZALJKA DVOREDNA PA 4-6mm ² 12P	144
UW23--	STEZALJKA DVOREDNA PA 10mm ² 12P	144
UW40--	STEZALJKA BEZ VIJAKA PA 1,5mm ² 3P	145
UW41--	STEZALJKA BEZ VIJAKA PA 1,5mm ² 5P	145
UW42--	STEZALJKA BEZ VIJAKA PA 1,5mm ² 8P	145
UW45--	STEZALJKA BEZ VIJAKA PA 2,5mm ² 3P	145
UW46--	STEZALJKA BEZ VIJAKA PA 2,5mm ² 4P	145
UW47--	STEZALJKA BEZ VIJAKA PA 2,5mm ² 5P	145
UW50--	STEZALJKA BEZ VIJAKA PA 2,5mm ² 2/1P	145

distribucija

šifra	opis proizvoda	stranica
KUČIŠTA CUBO IP20 AC		
AC11--	+	148
AC21--	KUČIŠTE NO CUBO S DNOM IP20 2M	148
AC41--	KUČIŠTE NO CUBO S DNOM IP20 4M	148
AC61--	KUČIŠTE NO CUBO S DNOM IP20 6M	148
KUČIŠTA CUBO IP55 AQ		
AQ20--	KUČIŠTE NO CUBO IP55 2M	149
AQ22--	KUČIŠTE NO CUBO IP55 2x2M	149
AQ30--	KUČIŠTE NO CUBO IP55 3M	149
AQ31--	KUČIŠTE PO CUBO IP55 3M	149

PARAPETNI KANALI ALUMINIJSKI MA

RT10	ADAPTER MA 92	150
RT12--	OKVIR MA 92 2/3M	150
RT14--	OKVIR MA 92 4M	150
RT17--	OKVIR MA 92 7M	150
RT20--	OSNOVA KANALA MA 130x65	151
RT21--	OSNOVA KANALA MA 165x65	151
RT25--	POKROV KANALA MA 92	151
RT30	PREGRAĐA MA 43	151
RT31	PREGRAĐA AL. MA 43	151
RT32	PREGRAĐA AL. MA DUPLA 43	151
RT35--	ZAVRŠNI ELEMENT MA 130x65	152
RT36--	ZAVRŠNI ELEMENT MA 165x65	152
RT38	RAVNI VEZNI ELEMENT MA 65	152
RT40--	UNIVERZALNI KUT MA 130x65	152
RT41--	UNIVERZALNI KUT MA 165x65	152
RT42	STEZALJKA ZA UZEMLJENJE MA 2x A6,3	152
RT43--	L KUTNI ELEMENT MA 130x65	153
RT44--	L KUTNI ELEMENT MA 165x65	153
RT45--	T DIO MA 130x65	153
RT46--	T DIO MA 165x65	153
RT50--	NOSAČ STUPIČA MA JEDNOSTRUKI 130x65	154
RT51--	NOSAČ STUPIČA MA DVOSTRUKI 2X 130x65	154
RT52--	STUPIČ MA 130x65x500	154
RT53--	STUPIČ MA DVOSTRUKI 2x 130x65x500	154

TALNE DOZE MTPODNE KUTIJE MT

RB30	PODNA KUTIJA MT 7 H=53mm	156
RB40	PODNA KUTIJA MT 7 H=88mm	156
RB31	PODNOŽJE ZA PODNU KUTIJU MT 7 H=53mm	156
RB41	PODNOŽJE ZA PODNU KUTIJU MT 7 H=88mm	156
RB33	PODNA KUTIJA MT 14 H=53mm	156
RB43	PODNA KUTIJA MT 14 H=88mm	156
RB34	PODNOŽJE ZA PODNU KUTIJU MT 14 H=53mm	157
RB44	PODNOŽJE ZA PODNU KUTIJU MT 14 H=88	157
RB36	PODNA KUTIJA MT 21 H=53mm	157
RB46	PODNA KUTIJA MT 21 H=88mm	157
RB37	PODNOŽJE ZA PODNU KUTIJU T 21 H=53mm	157
RB47	PODNOŽJE ZA PODNU KUTIJU MT 21 H=88mm	157

RAZVODNI ORMARI MO

RB10	ADAPTER ZA DIN-LETVU 35mm 1M	158
RB11	ADAPTER ZA DIN-LETVU 35mm 2M	158
RB20	RAZVODNI ORMAR MO 12+2	159
RB21	RAZVODNI ORMAR MO 24+4	159
RB22	RAZVODNI ORMAR MO 36+6	159
RB23	RAZVODNI ORMAR MO 48+8	159

ekonomik

šifra	opis proizvoda	stranica	šifra	opis proizvoda	stranica
PREKIDAČI SE			ELEKTRONIKA EE		
SE10	PREKIDAČ JEDNOPOLNI 10AX 250V~	172	EE15	DIMER ROTACIJSKI MEN RL 400W	188
SE11	TIPKALO JEDNOPOLNO 10A 250V~	172	EE16	DIMER ROTACIJSKI MEN RLC 400W	188
SE22	PREKIDAČ DVOPOLNI 16AX 250V~	172	EE17	DIMER ROTACIJSKI FAN 600VA	189
SE50	PREKIDAČ SERIJSKI 10AX 250V~	172	EE19	DIMER ROTACIJSKI MEN LED 100W	189
SE51	TIPKALO SERIJSKO 10A 250V~	173	EE15--	DIMER ROTACIJSKI MEN RL 400W	189
SE52	PREKIDAČ ZA ŽALUZINE 10AX 250V~	173	EE16--	DIMER ROTACIJSKI MEN RLC 400W	189
SE53	TIPKALO ZA ŽALUZINE 10A 250V~	173	EE19--	DIMER ROTACIJSKI MEN LED 100W	190
SE60	PREKIDAČ IZMJENIČNI 10AX 250V~	173	EE32--	IR PREKIDAČ 5A 250V~	190
SE63	PREKIDAČ DUPLI IZMJENIČNI 10AX 250V~	173	POKLOPCI ELEKTRONIKE PE		
SE70	PREKIDAČ KRIŽNI 10AX 250V~	173	PE40--	POKLOPAC DIMER PREKIDAČ Ø4	192
SE10--	PREKIDAČ JEDNOPOLNI 10AX 250V~	174	PE41--	POKLOPAC DIMER PREKIDAČ Ø6	192
SE10--IN	PREKIDAČ JEDNOPOLNI 10AX 250V~ IN	174	PRIBOR AE		
SE11--	TIPKALO JEDNOPOLNO 10A 250V~	174	AE10--	PUNILO	193
SE11--TI50	TIPKALO JEDNOPOLNO 10A 250V~ TI 50	174	AE20--	PRIKLJUČAK PETEROPOLNI STALNI 3P+N+E 5x4mm ²	193
SE11--TI51	TIPKALO JEDNOSTRUKO 10A 250V~ TI 51	174	AE30--	KUČIŠTE NO 1	193
SE11--IL	TIPKALO JEDNOPOLNO 10A 250V~ IL	174	AE50--	ZAŠTITA ZIDNA	194
SE22--NT03	PREKIDAČ DVOPOLNI 10AX 250V~ NT 03	174	AE51--	ZAŠTITA ZA UTIČNICE DJEČJA	194
SE50--	PREKIDAČ SERIJSKI 10AX 250V~	175	OKVIRI OE		
SE51--	TIPKALO SERIJSKO 10A 250V~	175	OE10--	OKVIR EKONOMIK 1	195
SE52--NT09	PREKIDAČ ZA ŽALUZINE 10AX 250V~ NT 09	175	OE20--	OKVIR EKONOMIK 2 HORIZONTALNI	195
SE53--NT09	TIPKALO ZA ŽALUZINE 10A 250V~ NT 09	175	OE21--	OKVIR EKONOMIK 2 VERTIKALNI	195
SE60--	PREKIDAČ IZMJENIČNI 10AX 250V~	175	OE30--	OKVIR EKONOMIK 3 HORIZONTALNI	195
SE63--	PREKIDAČ DUPLI IZMJENIČNI 10AX 250V~	175	OE31--	OKVIR EKONOMIK 3 VERTIKALNI	196
SE70--	PREKIDAČ KRIŽNI 10AX 250V~	175	OE40--	OKVIR EKONOMIK 4 HORIZONTALNI	196
TIPKE TE			OE41--	OKVIR EKONOMIK 4 VERTIKALNI	196
TE10--	TIPKA OBIČNA	176	OE90--	OKVIR EKONOMIK DEKORATIVNI	196
TE10--IN	TIPKA OBIČNA IN	176	fontana		
TE13--IL	TIPKA S NATPISNOM PLOČICOM IL	176	šifra	opis proizvoda	stranica
TE11--	TIPKA SERIJSKA	176	PREKIDAČI SF		
INDIKACIJA IA			SF10--	PREKIDAČ JEDNOPOLNI IP44 10A 250V~	200
IA10--	TINJALICA 220V~ 0,25W	177	SF10--TI	PREKIDAČ JEDNOPOLNI IP44 10A 250V~ TI	200
IA20--	SIJALICA LED 220V~ 4W	177	SF11--TI	TIPKALO JEDNOPOLNO IP44 10A 250V~ TI	200
IA21--	SIJALICA LED 24V AC/DC 0,5W	177	SF20--	PREKIDAČ DVOPOLNI IP44 10A 250V~	200
IA22--	SIJALICA LED 12V AC/DC 0,25W	177	SF50--	PREKIDAČ SERIJSKI IP44 10A 250V~	201
UTIČNICE VE			SF51--	TIPKALO SERIJSKO IP44 10A 250V~	201
VE10--XO	UTIČNICA SCHUKO+KS 2P+E 16A 250V~ XO	180	SF60--	PREKIDAČ IZMJENIČNI IP44 10A 250V~	201
VE11--XO	UTIČNICA SCHUKO+POKLOPAC 2P+E 16A 250V~ XO	180	SF60--TI	PREKIDAČ IZMJENIČNI IP44 10A 250V~ TI	201
VE12--XO	UTIČNICA SCHUKO 2P+E 16A 250V~ BV XO	180	SF63--	PREKIDAČ DVOSTRUKI IZMJENIČNI IP44 10A 250V~	201
VE13--XO	UTIČNICA SCHUKO+POKLOPAC 2P+E 16A 250V~ BV XO	180	SF70--	PREKIDAČ KRIŽNI IP44 10A 250V~	201
VE10--	UTIČNICA SCHUKO 2P+E 16A 250V~	180	UTIČNICE VF		
VE11--	UTIČNICA SCHUKO+POKLOPAC 2P+E 16A 250V~	180	VF10--	UTIČNICA SCHUKO+POKLOPAC IP44 2P+E 16A 250V~	202
VE12--	UTIČNICA SCHUKO 2P+E 16A 250V~ BV	180	VF12--	UTIČNICA SCHUKO+POKLOPAC IP44 2P+E 16A 250V~ BV	202
VE13--	UTIČNICA SCHUKO+POKLOPAC 2P+E 16A 250V~ BV	180	SETOVI CF		
VE40--XO	UTIČNICA FRANCUSKA 2P+E 16A 250V~ XO	181	CF10--	SET UTIČNICA SCHUKO DVOSTRUKA HORIZ IP44 2x2P+E 16A 250V~	203
VE41--XO	UTIČNICA FRANCUSKA+POKLOPAC 2P+E 16A 250V~ XO	181	CF11--	SET UTIČNICA SCHUKO DVOSTRUKA VERT IP44 2x2P+E 16A 250V~	203
VE42--XO	UTIČNICA FRANCUSKA 2P+E 16A 250V~ BV XO	181	CF12--	SET UTIČNICA SCH + PREKIDAČ MEN HOR IP44 16A + 10AX 250V~	203
VE43--XO	UTIČNICA FRANCUSKA+POKLOPAC 2P+E 16A 250V~ BV XO	181	CF13--	SET UTIČNICA SCH + PREKIDAČ MEN VERT IP44 16A + 10AX 250V~	204
VE40--	UTIČNICA FRANCUSKA 2P+E 16A 250V~	181	CF14--	SET UTIČNICA SCHUKO DVOSTRUKI HOR IP44 2x 2P+E 16A 250V~ BV	204
VE41--	UTIČNICA FRANCUSKA+POKLOPAC 2P+E 16A 250V~	181	CF15--	SET UTIČNICA SCHUKO DUPLI VERT IP44 2x 2P+E 16A 250V~ BV	204
VE42--	UTIČNICA FRANCUSKA 2P+E 16A 250V~ BV	181	CF16--	SET UTIČNICA SCH + PREKIDAČ MEN HOR IP44 16A + 10AX 250V~ BV	204
VE43--	UTIČNICA FRANCUSKA+POKLOPAC 2P+E 16A 250V~ BV	181	CF17--	SET UTIČNICA PREKIDAČ MEN VERT IP44 16A + 10AX 250V~ BV	204
VE16--	UTIČNICA SCHUKO DVOSTRUKA 2P+E 16A 250V~	182	PRIBOR AF		
VE46--	UTIČNICA FRANCUSKA DVOSTRUKA 2P+E 16A 250V~	182	AF10--	RAZVODNIK IP44 RN01	205
VE30--	UTIČNICA 2P 16A 250V~	182	AF20--	RAZVODNIK IP55 ND01	205
KOMUNIKACIJE KE					
KE11	UTIČNICA TV-R ZAVRŠNA 2dB	183			
KE12	UTIČNICA TV-R PRIJELAZNA 8,5dB	183			
KE16	UTIČNICA SAT-TV-R ZAVRŠNA 3dB	183			
KE36	UTIČNICA TEL KS RJ11 6/4	183			
KE37	UTIČNICA CAT5e KS RJ45 8/8	184			
KE38	UTIČNICA TEL KS DVOSTRUKA 2x RJ11 6/4	184			
KE39	UTIČNICA CAT5e KS DVOSTRUKA 2x RJ45 8/8	184			
KE45	ADAPTER KS	184			
KE46	ADAPTER KS DVOSTRUKI	184			
KE47	ADAPTER PD DVOSTRUKI	184			
KE10--	UTIČNICA TV OSNOVNA 0dB	185			
KE11--	UTIČNICA TV-R ZAVRŠNA 2dB	185			
KE12--	UTIČNICA TV-R PRIJELAZNA 8,5dB	185			
KE16--	UTIČNICA SAT-TV-R ZAVRŠNA 3dB	185			
KE22--	UTIČNICA AUDIO 2xRCA	185			
KE23--	UTIČNICA AUDIO ZA ZVUČNIKE	185			
KE36--	UTIČNICA TEL KS RJ11 6/4	186			
KE37--	UTIČNICA CAT5e KS RJ45 8/8	186			
KE38--	UTIČNICA TEL KS DVOSTRUKA 2x RJ11 6/4	186			
KE39--	UTIČNICA CAT5e KS DVOSTRUKA 2x RJ45 8/8	186			
KE35--	UTIČNICA TEL LT RJ11 6/4	186			
POKLOPCI PA					
PE10--	POKLOPAC TV-R 2P/3P	187			
PE20--	POKLOPAC KS JEDNOSTRUKI	187			
PE21--	POKLOPAC KS/PD DVOSTRUKI	187			
PE30--	POKLOPAC TAE/TDO	187			

I N D E X



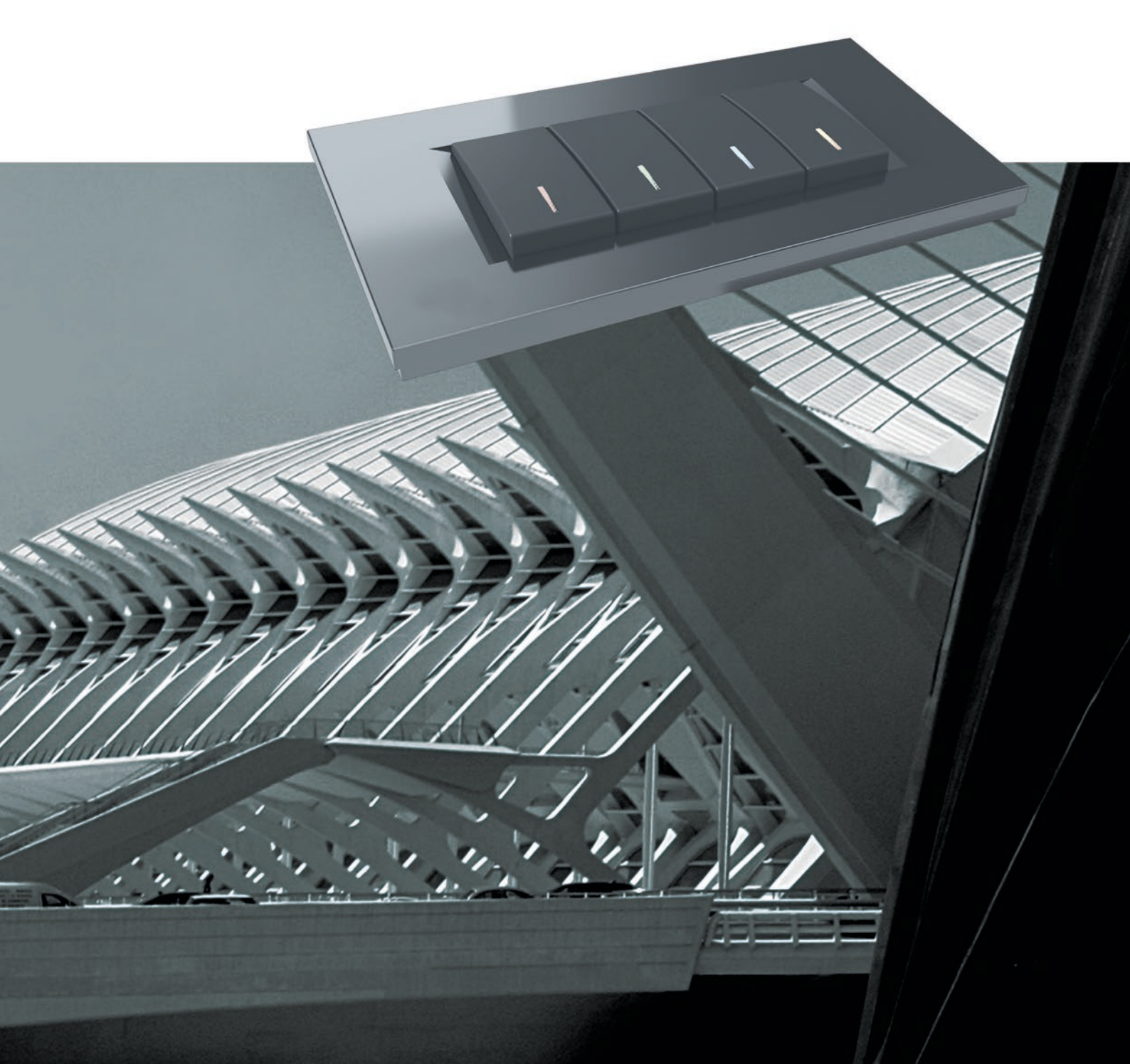

TEM

TEM ČATEŽ d.d.
Čatež 13, 8212 VELIKA LOKA
SLOVENIJA

tem@tem.si
www.tem.si

T +386(0)7 348 99 00
F +386(0)7 348 99 99

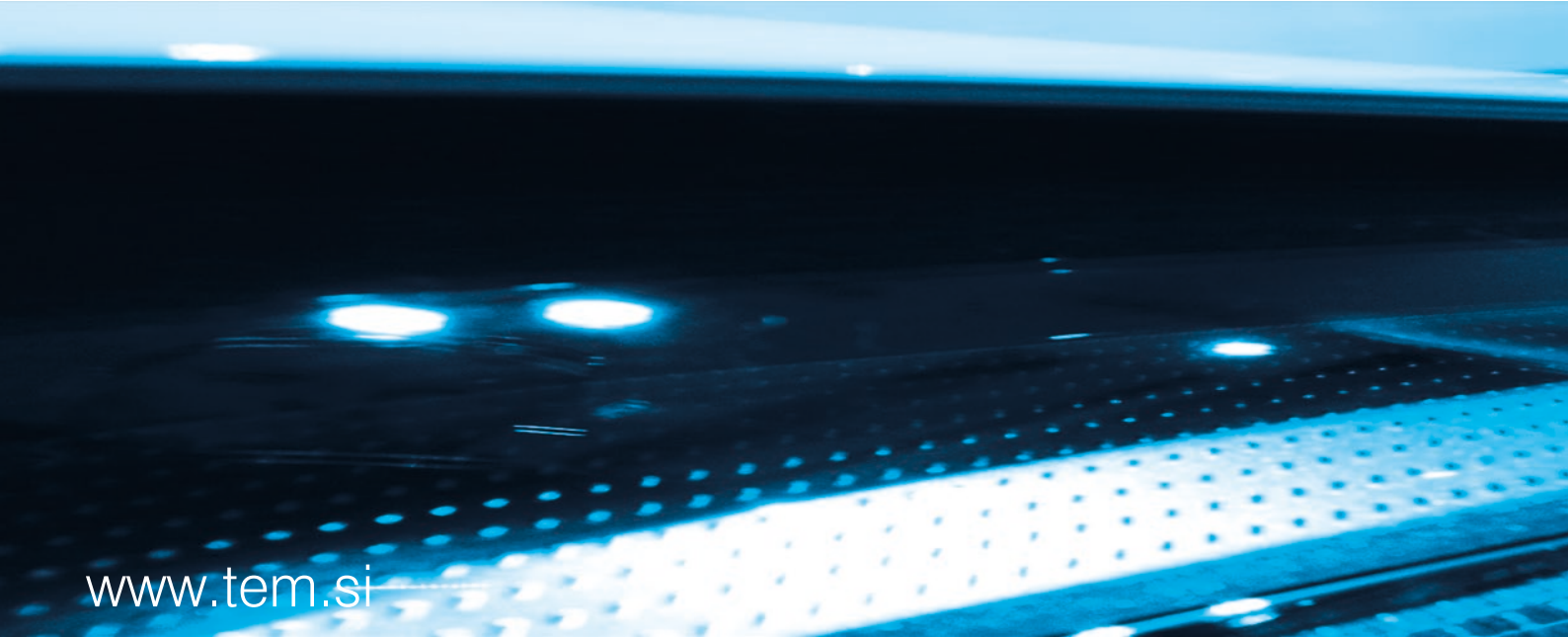

www.tem.si

JVE
2016/2017