

TEM

On | Off and everything in between

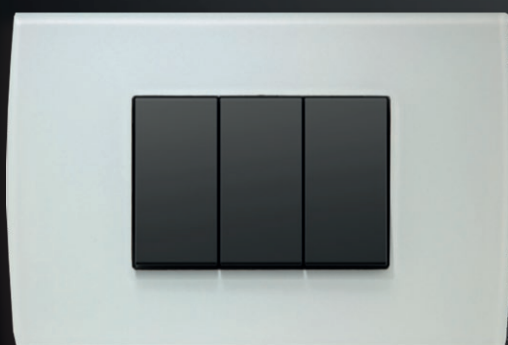

2022

MODUL



MODUL
LINE



MODUL
SOFT



MODUL
PURE

38

LOGIQ



146

ekonomik



176

fontana



214



TEM

On | Off and everything in between



Ние сме водещият производител на ключове и контакти в региона. Вече половин век ние предоставяме на нашите потребители позитивна и лесна практическа работа, лесен монтаж и използване на продуктите, широка гама от цветове и материали, които убеждават дори най-взискателните.

We are the leading manufacturer of switches and sockets in the region. For half a century, we have been providing our users a positive and easy experience, simple installation and use of products, a wide range of colours and materials, which convince even the most demanding.

TEM

Добре дошли в семейството MODUL
Welcome to the MODUL family

Добавете лична нотка към атмосферата си и покажете
стила си с ключове и контакти от семейството MODUL.

*Give your ambience a personal touch and show off your style with
switches and sockets from MODUL family.*

откриване на нови прозрения
discovering new insights



MODUL

LINE



MODUL

SOFT



MODUL

PURE

MODUL

Изберете своя
ДИЗАЙН
Select your DESIGN

Изберете своя
ЦВЯТ
Select your COLOUR

1

2

MODUL

LINE



MODUL

SOFT



MODUL

PURE



метал

стъкло

дърво

3



9

4

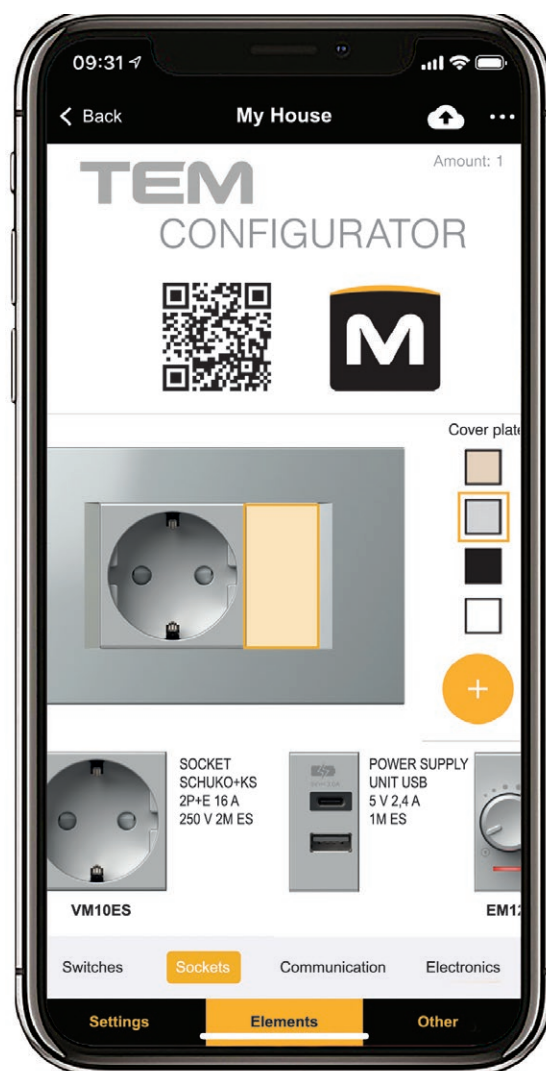

MODUL

LINE



Правите, плавни линии създават дизайн, неподвластен на времето.

Straight, smooth lines create a timeless design.





MODUL

LINE

PW

IW

ES

AT

SB



полярно бяло слонова кост елоксирано антрацит меко черно
сребро

polar white

ivory white

elox silver

anthracite

*soft touch
black*

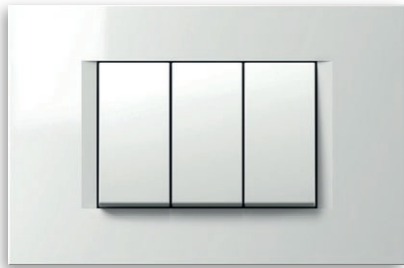

PW полярно бяло
polar white

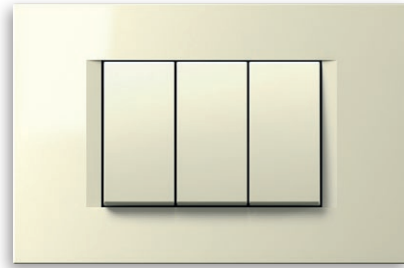

IW слонова кост
ivory white



SW каменно бяло
stone white

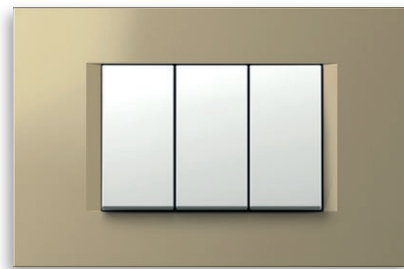

SG пясъчно злато
sand gold



ES елоксирано сребро
elox silver

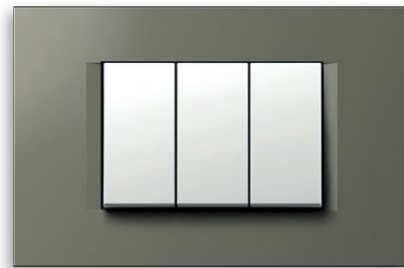

TI титан
titanium

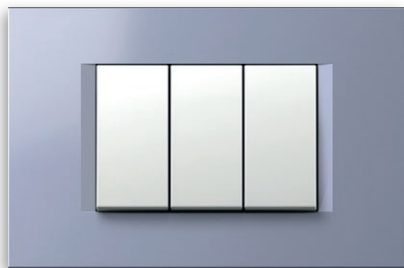

IB импулсивно синьо
impulse blue

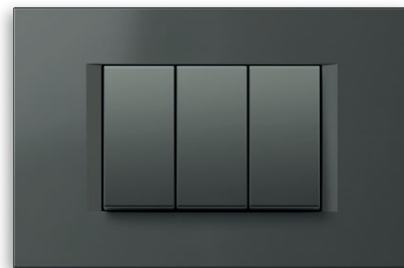

AT антрацит
anthracite



NB нощно черно
night black

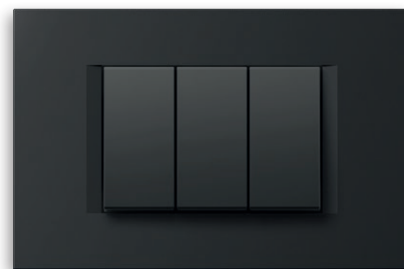

SB меко черно
soft touch black

MODUL

SOFT

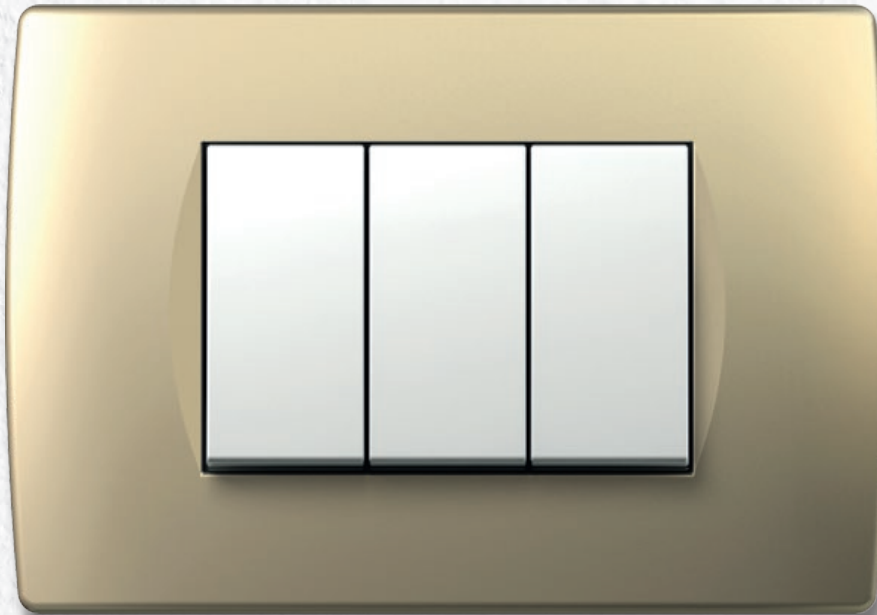

Заоблените форми и леките преходи внасят мекота във вашия дом.

Rounded shapes and soft transitions bring softness into your home.





MODUL

SOFT

PW

IW

ES

AT

SB



полярно бяло слонова кост елоксирано антрацит меко черно

сребро

polar white

ivory white

elox silver

anthracite

*soft touch
black*

Изберете своя цвят
Select your colour

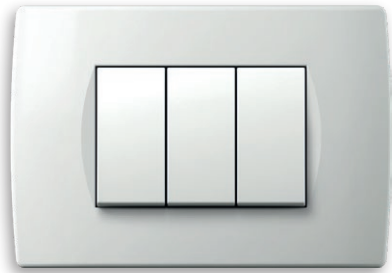

PW полярно бяло
polar white

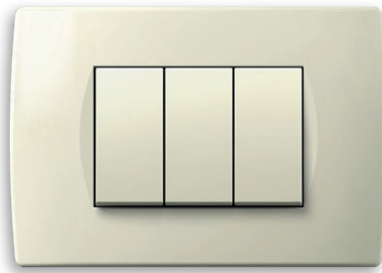

IW слонова кост
ivory white



ES елоксирано сребро
elox silver

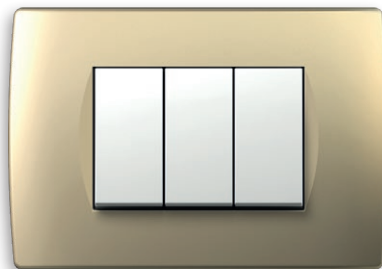

SG пясъчно злато
sand gold



WW титан
walnut

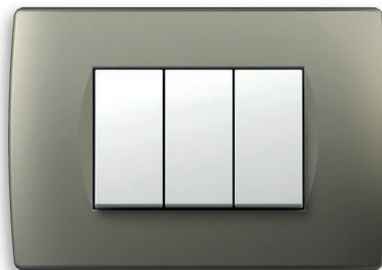

TI титан
titanium



WE венге
wenge

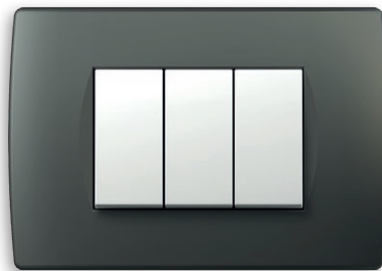

AT антрацит
anthracite



NB нощно черно
night black



SB меко черно
soft touch black

MODUL

PURE

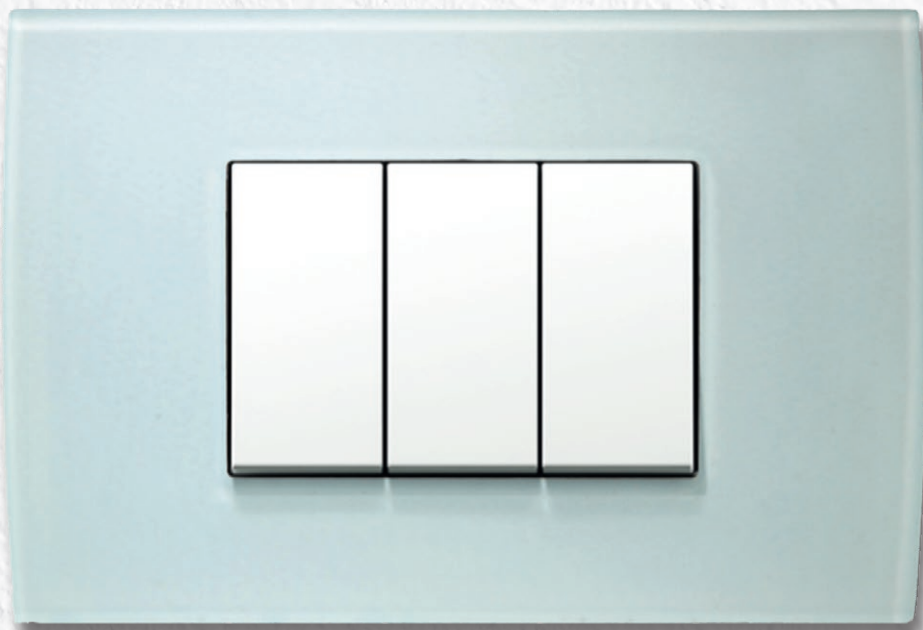

Детайлите представляват завършеността на цялата атмосфера. Оставете природата да обогати пространството ви с декоративни панели, изработени от дърво, стъкло и метал.

The details represent the completeness of the entire ambience. Let the nature enrich your space with decorative cover plates made of wood, glass and metal.





MODUL

PURE

PW



polar white

IW



ivory white

ES



elox silver

AT



anthracite

SB



soft touch black

СТЪКЛО
glass



GW ледено бяло
ice white

МЕТАЛ
metal



MH кована стомана
hammered steel

ДЪРВО
wood



WM клен
maple

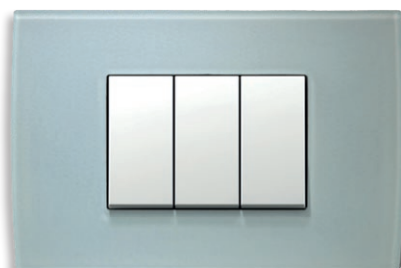

GG ледено зелено
ice green

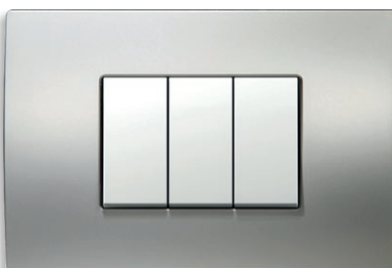

MS сатенирано сребро
satın silver



WB бамбук
bamboo

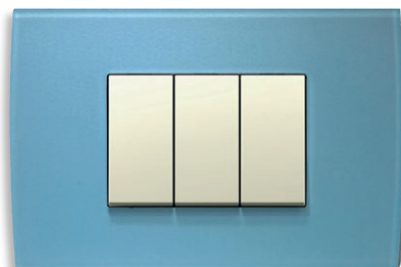

GB ледено синьо
ice blue



MN сатениран никел
satın nickel



WW орех
walnut



GY ледено сиво
ice grey



ME гравирано желязо
etched iron



WE венге
wenge

MODUL

PURE



СТЪКЛО – леко и изискано.
Оставете свежестта да навлезе в дома ви.

*GLASS - light and sophisticated.
Let freshness breeze through your home.*





СТЪКЛО
glass

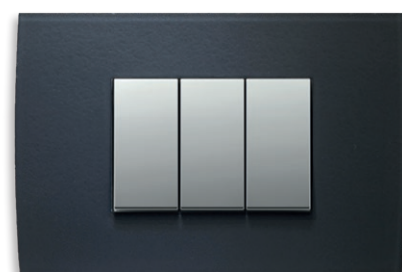
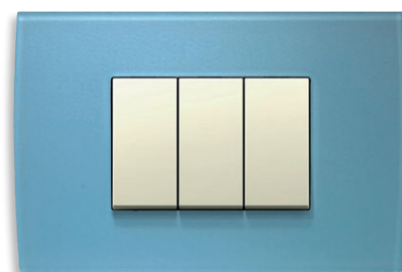
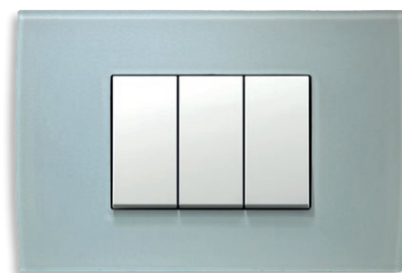

MODUL

PURE



МЕТАЛ – студено, но благородно.
Прегърнете този изчистен материал и
привличайте неусетно вниманието.

METAL - cold, yet noble.

*Embrace this pristine material and
effortlessly catch attention.*





метал
metal

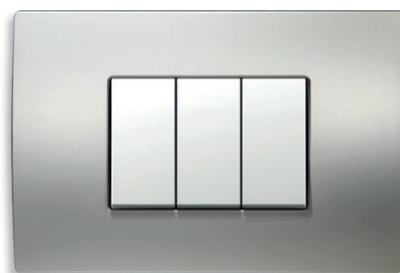

MODUL

PURE



ДЪРВО – универсално, но същевременно
уникално.
Отстъпете място за топлината на природата.

*WOOD - versatile, yet unique.
Give way to nature's warmth.*





дърво
wood



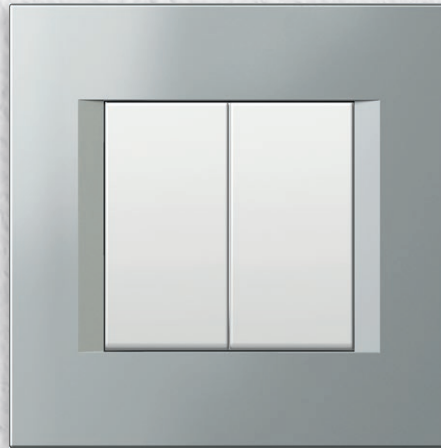

MODUL

- LINE
- SOFT
- PURE



+

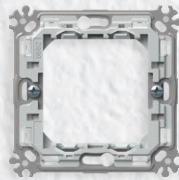

+



2M



2 x 2M



3 x 2M



4 x 2M





5 x 2M

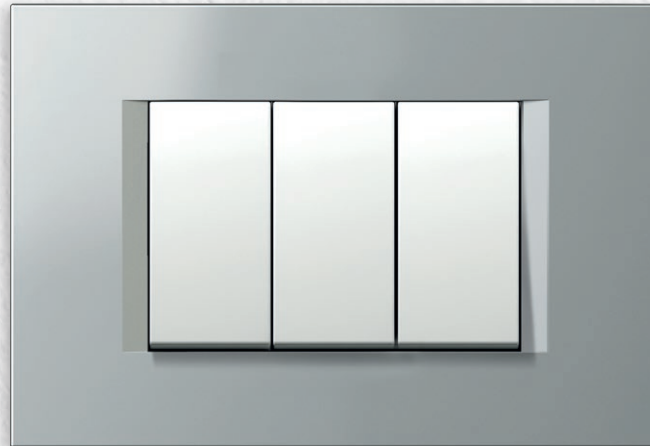



MODUL

-  LINE
-  SOFT
-  PURE



2 x 7M

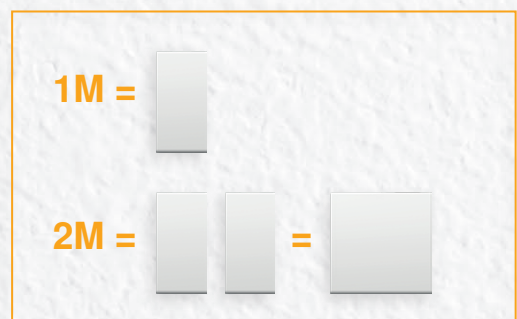

Функционалните елементи се монтират лесно в монтажната рамка.

Решението „щракване за поставяне, щракване за изваждане“, което сме разработили за вас, намалява времето за монтиране. Достъпът до контактите за съединяване е лесен откъм предната страна.

The function elements are easily fitted inside the mounting frame.

The “klik-in, klik-out” solution we have developed for you will reduce installation time. The connection contacts are easily accessible from the front.

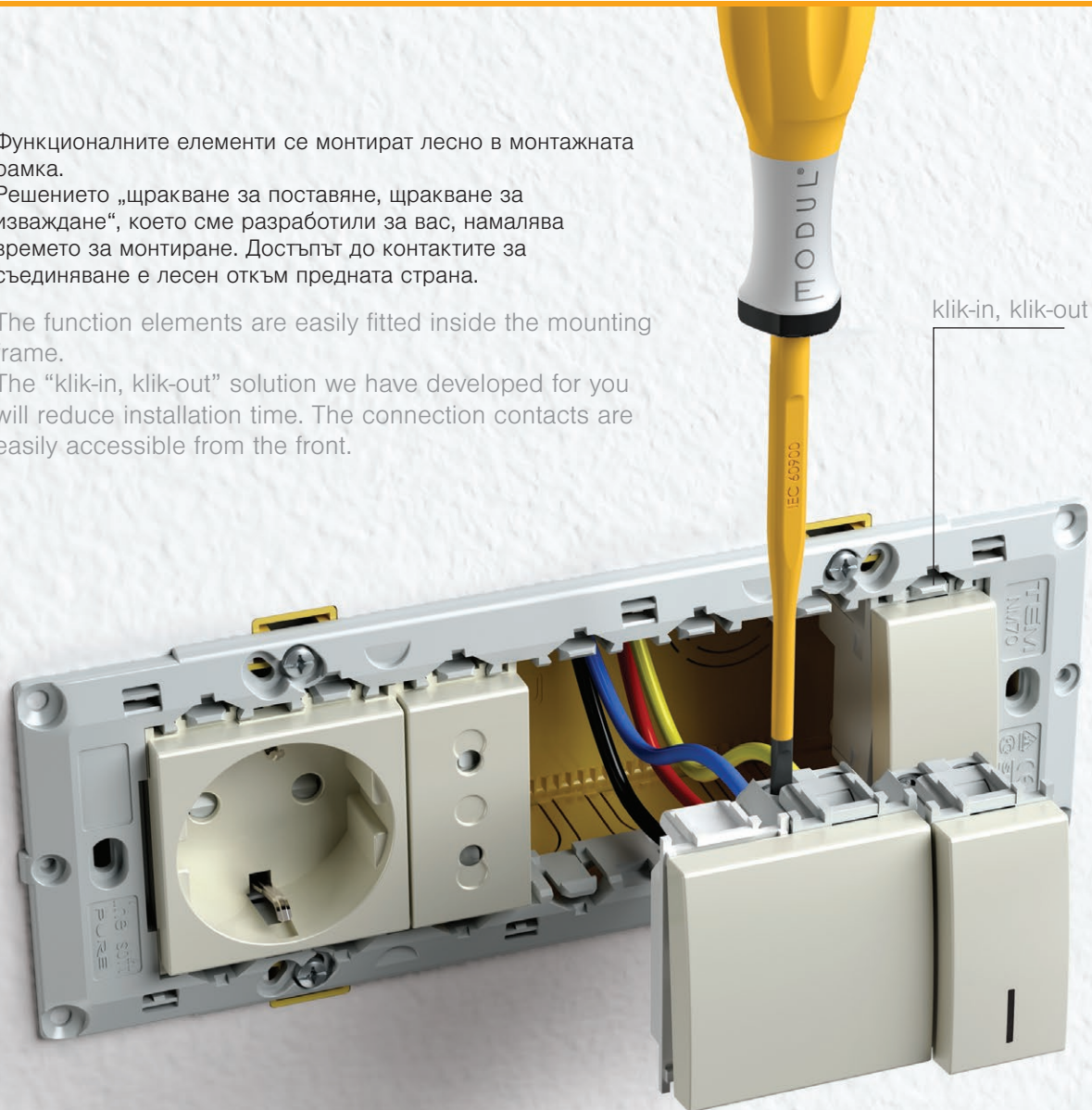

Modul е подходящ за всички видове стени и може да се използва в обикновени конструкции, както и за кухи стени или бетон. Инсталирането е лесно и ви дава възможност лесно да инсталирате и комбинирате правилните разстояния за правоъгълни и кръгли конзоли. Използваните материали отговарят на високи стандарти.

The Modul is suitable for all wall types and can be used in conventional, hollow wall or concrete constructions. It is easy to install and enables you to combine rectangular or round boxes at the proper distances. The materials used are compliant with high standards.



тухла / brick



куха стена / hollow wall



бетон / concrete

Modul предоставя голям брой възможности даже с кръгли конзоли. Можете да ги комбинирате хоризонтално или вертикално, самостоятелно или във вид на групи. Металната монтажна рамка гарантира отлична стабилност дори при работа с кръгли елементи и е подходяща за всякакви декоративни панели.

The Modul enables a many possibilities even with round boxes. You can combine them horizontally or vertically, individually or in groups. The metal mounting frame ensures excellent stability even with rough use and is suitable for any decorative cover plates.

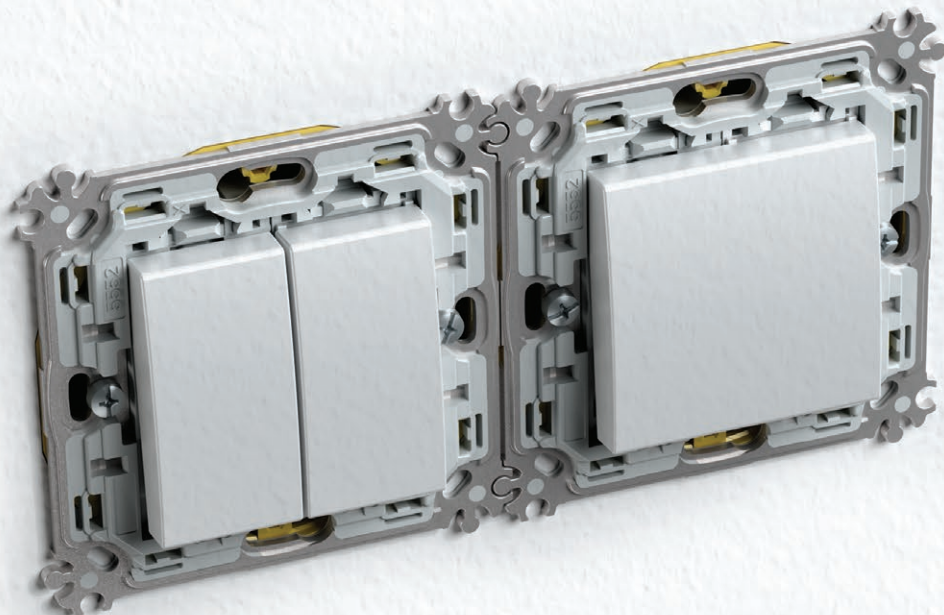



□ PW полярно бяло
polar white



■ SB меко черно
soft touch black



■ AT антрацит
anthracite



□ ES елоксирано сребро
elox silver



□ IW слонова кост
ivory white



СИМВОЛИ
SYMBOLS

01	02	03	04	05	06	07	08	09	10	11	12	20	21	22	23
24	25	26	27	28	29	30	31	32	33	34	35	36	37	38	39
					OFF	ON					AC				
40	41	42	43	44	45	46	47	48							

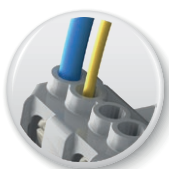
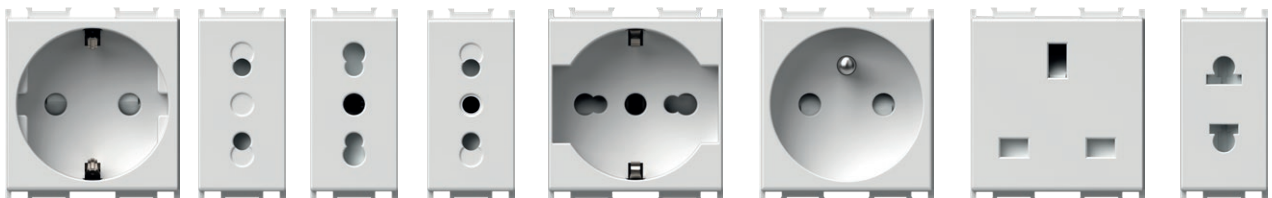

Надеждно свързване, дори при използване на проводници с различно сечение.

Reliable connection even when different size of wires are used.



Всички контакти са оборудвани за безопасно изключване, което гарантира защитата на контактите, които са под напрежение.

All the sockets are equipped with a safety shutters assuring the protection to live contacts.

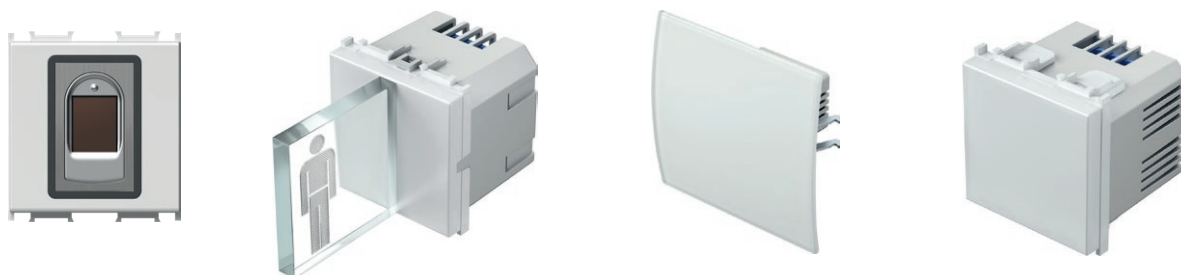
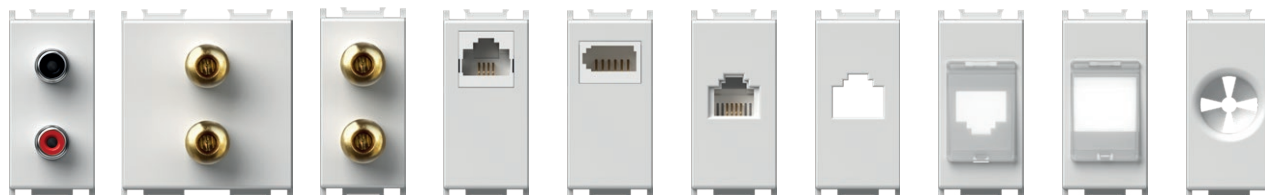

Дълъг експлоатационен живот на ключовете и съответствие с изискванията на международните стандарти.

Long-life of switches and adequacy to the international standards.



Ключът е с висока надеждност, благодарение на своите контакти със сребърни нитове.

The switch is highly reliable via its silver rivets contacts.





BIOPASS – ключ с четец за пръстов отпечатък
BIOPASS - fingerprint switch

Отключване без ключ.
Keyless unlocking.

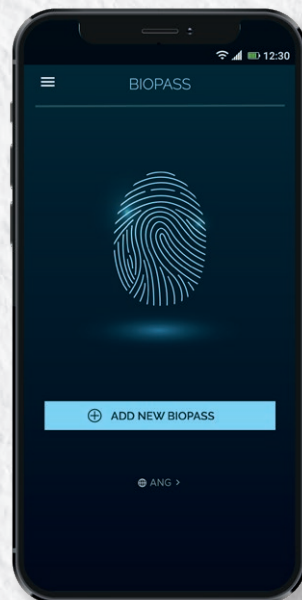

МУЛТИМЕДИЯ
MULTIMEDIA

Мултимедиен център, който ви дава възможност да свързвате няколко компонента на едно място.
Multimedia center that allows you to connect a multiple number of components in one place.



TOUCH – универсален димер

TOUCH - universal dimmer

Включване и димиране на различни лампи

Switching and dimming of different lamps

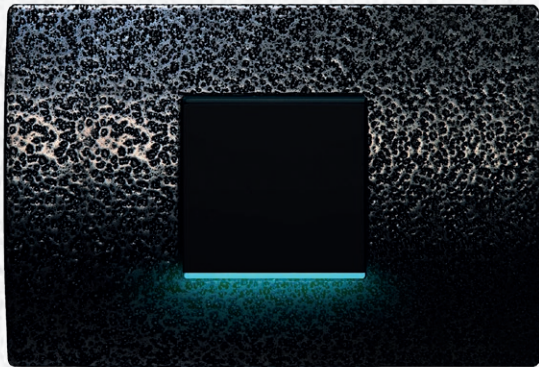

СЪЗДАЙТЕ СВОЙ СОБСТВЕН

CREATE YOUR OWN

Когато поръчвате големи количества, декоративните панели и функционалните елементи могат да бъдат изработени в изборния от вас цвят.

When ordering large quantities, cover plates and function elements can be made in the colour of your choice.



НАПРАВЕТЕ ГО УНИКАЛНО

MAKE IT UNIQUE

Изберете цвета на осветлението и добавете желаната графика, която ще подхожда на атмосферата на вашата стая.

Choose a illumination colour and add desired graphic to suit the ambience of your room.



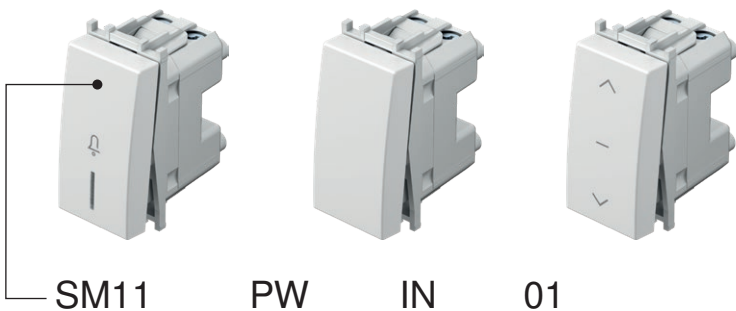

тип type	описание description	технически данни technical data	размер size	цвет colour	допълнителна информация 1 optional data 1	допълнителна информация 2 optional data 2
SM10	КЛЮЧ 1WAY SWITCH 1WAY	16AX 250V~	1M	□ PW снежнобял цвет polar white	NT неутрален neutral	🔔 01
SM11	БУТОН 1WAY PUSH BUTTON 1WAY	16A 250V~	1M	■ SB сензорен бутон черен soft touch black	IN индикатор indicator	🔦 02
SM12	КЛЮЧ 1WAY SWITCH 1WAY	20A 250V~	1M	■ AT антрацит anthracite		0 03
⋮	⋮	⋮	⋮	□ ES сребрист elox silver		
⋮	⋮	⋮	⋮	■ IW слонова кост ivory white		

КЛЮЧ 1WAY 16AX 250V~ 1M



SM10



- ключ без бутон
 - 16 AX 250 V~, тип SM10
 - в съответствие с EN 60669-1
 - винтови контакти 1,5 - 2,5 mm²
- SWITCH 1WAY 16AX 250V~ 1M**
- switch without button
 - 16AX 250V~, type SM10
 - in accordance with EN 60669-1
 - screw contacts 1.5-2.5mm²

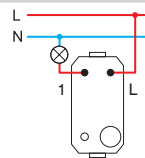

БУТОН 1WAY 16A 250V~ 1M



SM11



- бутон без клавиш за натискане
 - 16 A 250 V~, тип SM11
 - в съответствие с EN 60669-1
 - винтови контакти 1,5 - 2,5 mm²
- PUSH BUTTON 1WAY 16A 250V~ 1M**
- push button without button
 - 16A 250V~, type SM11
 - in accordance with EN 60669-1
 - screw contacts 1.5-2.5mm²

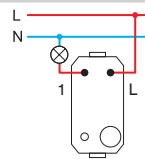

КЛЮЧ 1WAY 20A 250V~ 1M



SM12



- ключ без бутон
 - 20 A 250 V~, тип SM12
 - в съответствие с EN 60669-1
 - винтови контакти 1,5 - 2,5 mm²
- SWITCH 1WAY 20A 250V~ 1M**
- switch without button
 - 20A 250V~, type SM12
 - in accordance with EN 60669-1
 - screw contacts 1.5-2.5mm²

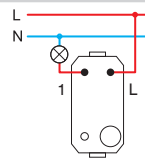

КЛЮЧ 2POLE 16AX 250V~ 1M



SM20



- ключ без бутон
 - 16 AX 250 V~, тип SM20
 - в съответствие с EN 60669-1
 - винтови контакти 1,5 - 2,5 mm²
 - само в комбинация с бутон TM15
- SWITCH 2POLE 16AX 250V~ 1M**
- switch without button
 - 16AX 250V~, type SM20
 - in accordance with EN 60669-1
 - screw contacts 1.5-2.5mm²
 - only in combination with button TM15

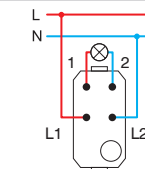

КЛЮЧ ЗА ЩОРИ 1-0-2 16AX 250V~ 1M



SM40



- ключ без бутон
 - 16 AX 250 V~, тип SM40
 - в съответствие с EN 60669-1
 - винтови контакти 1,5 - 2,5 mm²
- SWITCH SHUTTERS 1-0-2 16AX 250V~ 1M*
- switch without button
 - 16AX 250V~, type SM40
 - in accordance with EN 60669-1
 - screw contacts 1.5-2.5mm²

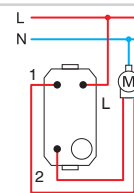

КЛЮЧ ЗА ЩОРИ 1-0-2 16A 250V~ 1M



SM41

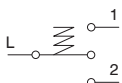

- бутон без клавиш за натискане
 - 16 A 250 V~, тип SM41
 - в съответствие с EN 60669-1
 - винтови контакти 1,5 - 2,5 mm²
- PUSH BUTTON SHUTTERS 1-0-2 16A 250V~ 1M*
- push button without button
 - 16A 250V~, type SM41
 - in accordance with EN 60669-1
 - screw contacts 1.5-2.5mm²

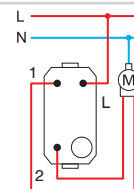

КЛЮЧ 2WAY 16AX 250V~ 1M



SM60

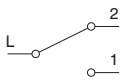

- ключ без бутон
 - 16 AX 250 V~, тип SM60
 - в съответствие с EN 60669-1
 - винтови контакти 1,5 - 2,5 mm²
- SWITCH 2WAY 16AX 250V~ 1M*
- switch without button
 - 16AX 250V~, type SM60
 - in accordance with EN 60669-1
 - screw contacts 1.5-2.5mm²

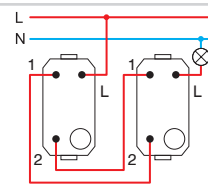

БУТОН 2WAY 16A 250V~ 1M



SM61

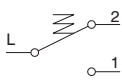

- бутон без клавиш за натискане
 - 16 A 250 V~, тип SM61
 - в съответствие с EN 60669-1
 - винтови контакти 1,5 - 2,5 mm²
- PUSH BUTTON 2WAY 16A 250V~ 1M*
- push button without button
 - 16A 250V~, type SM61
 - in accordance with EN 60669-1
 - screw contacts 1.5-2.5mm²

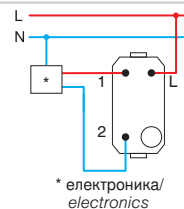

КРЪСТАТ КЛЮЧ 16AX 250V~ 1M



SM70

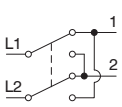

- ключ без бутон
 - 16 AX 250 V~, тип SM70
 - в съответствие с EN 60669-1
 - винтови контакти 1,5 - 2,5 mm²
- SWITCH INTERMEDIATE 16AX 250V~ 1M*
- switch without button
 - 16AX 250V~, type SM70
 - in accordance with EN 60669-1
 - screw contacts 1.5-2.5mm²

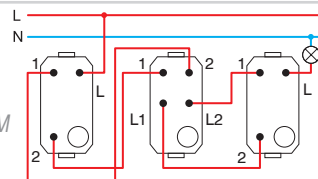

1M = 22,5 x 45
2M = 45 x 45

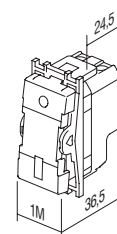
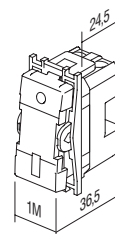

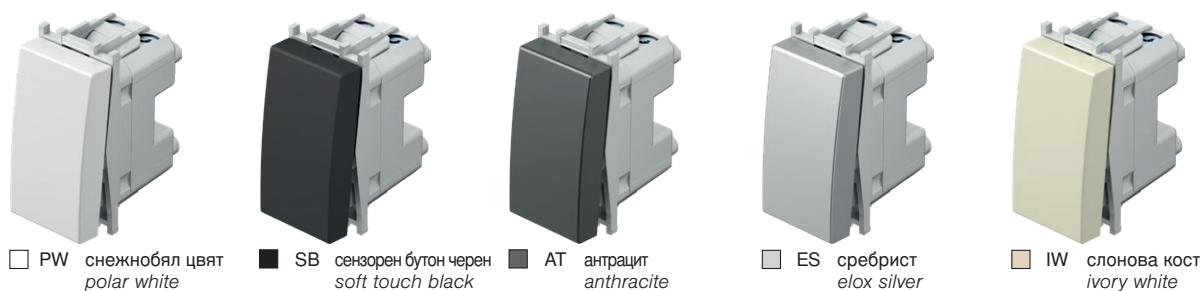

□ PW снежнобял цвят
polar white

■ SB сензорен бутон черен
soft touch black

■ AT антрацит
anthracite

□ ES сребрист
elox silver

□ IW слоновя кост
ivory white

КЛЮЧ 1WAY 16AX 250V~ 1M



- SM10PW
- SM10SB
- SM10AT
- SM10ES
- SM10IW

- 16 AX 250 V~, тип SM10
- в съответствие с EN 60669-1
- винтови контакти 1,5 - 2,5 mm²
- сменяем бутон

SWITCH 1WAY 16AX 250V~ 1M
- 16AX 250V~, type SM10
- in accordance with EN 60669-1
- screw contacts 1.5-2.5 mm²
- replaceable button



КЛЮЧ 1WAY 16AX 250V~ 1M __ IN



- SM10PWIN
- SM10SBIN
- SM10ATIN
- SM10ESIN
- SM10IWIN

- IN индикатор
- 16 AX 250 V~, тип SM10
- в съответствие с EN 60669-1
- винтови контакти 1,5 - 2,5 mm²
- лампата не е включена в доставката
- сменяем бутон

SWITCH 1WAY 16AX 250V~ 1M __ IN
- IN indicator
- 16AX 250V~, type SM10
- in accordance with EN 60669-1
- screw contacts 1.5-2.5 mm²
- lamp is not included
- replaceable button



БУТОН 1WAY 16A 250V~ 1M



- SM11PW
- SM11SB
- SM11AT
- SM11ES
- SM11IW

- 16 A 250 V~, тип SM11
- в съответствие с EN 60669-1
- винтови контакти 1,5 - 2,5 mm²
- сменяем бутон

PUSH BUTTON 1WAY 16A 250V~ 1M
- 16A 250V~, type SM11
- in accordance with EN 60669-1
- screw contacts 1.5-2.5 mm²
- replaceable button



БУТОН 1WAY 16A 250V~ 1M __ IN 01



- SM11PWIN01
- SM11SBIN01
- SM11ATIN01
- SM11ESIN01
- SM11IWIN01

- IN 01 звънчев индикатор
- 16 A 250 V~, тип SM11
- в съответствие с EN 60669-1
- винтови контакти 1,5 - 2,5 mm²
- лампата не е включена в доставката
- сменяем бутон

PUSH BUTTON 1WAY 16A 250V~ 1M __ IN 01
- IN 01 indicator bell
- 16A 250V~, type SM11
- in accordance with EN 60669-1
- screw contacts 1.5-2.5 mm²
- lamp is not included
- replaceable button



S W I T C H E S S M

БУТОН 1WAY 16A 250V~ 1M __ IN 02



- SM11PWIN02
- SM11SBIN02
- SM11ATIN02
- SM11ESIN02
- SM11IWIN02

- IN 02 светлинен индикатор
 - 16 A 250 V~, тип SM11
 - в съответствие с EN 60669-1
 - винтови контакти 1,5 - 2,5 mm²
 - лампата не е включена в доставката
 - сменяем бутон

PUSH BUTTON 1WAY 16A 250V~ 1M __ IN 02

- IN 02 indicator light
 - 16A 250V~, type SM11
 - in accordance with EN 60669-1
 - screw contacts 1.5-2.5 mm²
 - lamp is not included
 - replaceable button



КЛЮЧ 2POLE 16AX 250V~ 1M __ NT 03



- SM20PWNT03
- SM20SBNT03
- SM20ATNT03
- SM20ESNT03
- SM20IWNT03

- NT 03 неутрален 0-1
 - 16 AX 250 V~, тип SM20
 - в съответствие с EN 60669-1
 - винтови контакти 1,5 - 2,5 mm²
 - сменяем бутон

SWITCH 2POLE 16AX 250V~ 1M __ NT 03

- NT 03 neutral 0-1
 - 16AX 250V~, type SM20
 - in accordance with EN 60669-1
 - screw contacts 1.5-2.5 mm²
 - replaceable button



КЛЮЧ 2POLE 16AX 250V~ 1M __ IN



- SM20PWIN
- SM20SBIN
- SM20ATIN
- SM20ESIN
- SM20IWIN

- IN индикатор
 - 16 AX 250 V~, тип SM20
 - в съответствие с EN 60669-1
 - винтови контакти 1,5 - 2,5 mm²
 - лампата не е включена в доставката
 - сменяем бутон

SWITCH 2POLE 16AX 250V~ 1M __ IN

- IN indicator
 - 16AX 250V~, type SM20
 - in accordance with EN 60669-1
 - screw contacts 1.5-2.5 mm²
 - lamp is not included
 - replaceable button



КЛЮЧ ЗА ЩОРИ 1-0-2 16AX 250V~ 1M __ NT 10

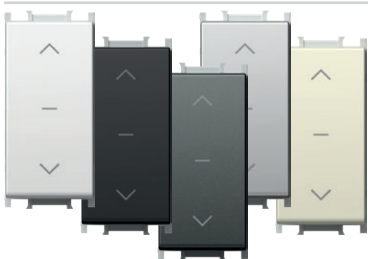

- SM40PWNT10
- SM40SBNT10
- SM40ATNT10
- SM40ESNT10
- SM40IWNT10

- NT 10 неутрален 1-0-2
 - 16 AX 250 V~, тип SM40
 - в съответствие с EN 60669-1
 - винтови контакти 1,5 - 2,5 mm²
 - сменяем бутон

SWITCH SHUTTERS 1-0-2 16AX 250V~ 1M __ NT 10

- NT 10 neutral 1-0-2
 - 16AX 250V~, type SM40
 - in accordance with EN 60669-1
 - screw contacts 1.5-2.5mm²
 - replaceable button



БУТОНИ ЗА ЩОРИ 1-0-2 16A 250V~ 1M __ NT 10

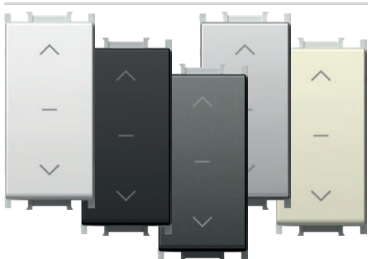

- SM41PWNT10
- SM41SBNT10
- SM41ATNT10
- SM41ESNT10
- SM41IWNT10

- NT 10 неутрален 1-0-2
 - 16 A 250 V~, тип SM41
 - в съответствие с EN 60669-1
 - винтови контакти 1,5 - 2,5 mm²
 - сменяем бутон

PUSH BUTTON SHUTTERS 1-0-2 16A 250V~ 1M __ NT 10

- NT 10 neutral 1-0-2
 - 16A 250V~, type SM41
 - in accordance with EN 60669-1
 - screw contacts 1.5-2.5mm²
 - replaceable button



КЛЮЧ 2WAY 16AX 250V~ 1M

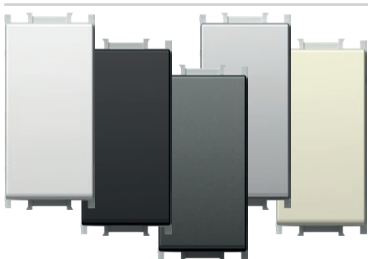

- SM60PW
- SM60SB
- SM60AT
- SM60ES
- SM60IW

- 16 AX 250 V~, тип SM60
 - в съответствие с EN 60669-1
 - винтови контакти 1,5 - 2,5 mm²
 - сменяем бутон

SWITCH 2WAY 16AX 250V~ 1M

- 16AX 250V~, type SM60
 - in accordance with EN 60669-1
 - screw contacts 1.5-2.5 mm²
 - replaceable button



БУТОН 2WAY 16A 250V~ 1M

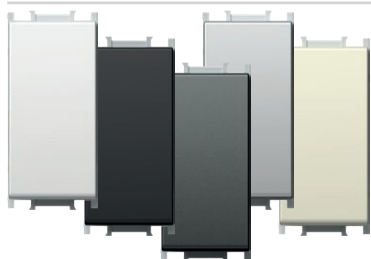

- SM61PW
- SM61SB
- SM61AT
- SM61ES
- SM61IW

- 16 A 250 V~, тип SM61
 - в съответствие с EN 60669-1
 - винтови контакти 1,5 - 2,5 mm²
 - сменяем бутон

PUSH BUTTON 2WAY 16A 250V~ 1M

- 16A 250V~, type SM61
 - in accordance with EN 60669-1
 - screw contacts 1.5-2.5 mm²
 - replaceable button



БУТОН С ШНУР 2WAY 16A 250V~ 1M



- SM62PWCD
- SM62SBCD
- SM62ATCD
- SM62ESCD
- SM62IWCD

- CD индикатор+шнур
 - дължина на шнура 1.5 m
 - 16 A 250 V~, тип SM62
 - в съответствие с EN 60669-1
 - винтови контакти 1,5 - 2,5 mm²

PUSH BUTTON 2WAY WITH CORD 16A 250V~ 1M __ CD

- CD indicator+cord
 - cord lenght 1.5m
 - 16A 250V~, type SM62
 - in accordance with EN 60669-1
 - screw contacts 1.5-2.5 mm²



КРЪСТАТ КЛЮЧ 16AX 250V~ 1M



- SM70PW
- SM70SB
- SM70AT
- SM70ES
- SM70IW

- 16 AX 250 V~, тип SM70
 - в съответствие с EN 60669-1
 - винтови контакти 1,5 - 2,5 mm²
 - сменяем бутон

SWITCH INTERMEDIATE 16AX 250V~ 1M

- 16AX 250V~, type SM70
 - in accordance with EN 60669-1
 - screw contacts 1.5-2.5 mm²
 - replaceable button



1M = 22,5 x 45
 2M = 45 x 45

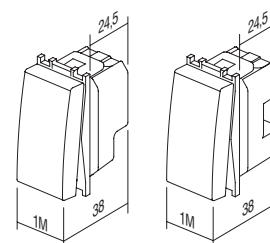

B U T T O N S T M

тип type	описание description	размер size	цвет colour	допълнителна информация 1 optional data 1	допълнителна информация 2 optional data 2
TM11	БУТОН BUTTON	1M	<input type="checkbox"/> PW снежнобял цвят polar white	<input type="checkbox"/> NT неутрален neutral	01
TM12	БУТОН BUTTON	2M	<input checked="" type="checkbox"/> SB сензорен бутон черен soft touch black	<input type="checkbox"/> IN индикатор indicator	02
TM21	КАПАЧЕ BLANK	1M	<input checked="" type="checkbox"/> AT антрацит anthracite		03
:	:	:	<input type="checkbox"/> ES сребрист elox silver		
:	:	:	<input type="checkbox"/> IW слонова кост ivory white		

БУТОН 1M

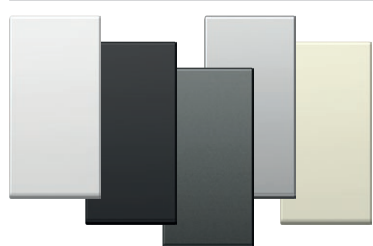

- TM11PW
- TM11SB
- TM11AT
- TM11ES
- TM11IW

- сменяем бутон 1M
- в съответствие с EN 60669-1

BUTTON 1M

- replaceable button 1M
- in accordance with EN 60669-1



БУТОН 1M С ИНДИКАТОР



- TM11PWIN
- TM11SBIN
- TM11ATIN
- TM11ESIN
- TM11IWIN

- сменяем бутон 1M
- в съответствие с EN 60669-1

BUTTON 1M INDICATOR

- replaceable button 1M
- in accordance with EN 60669-1



БУТОН 2M

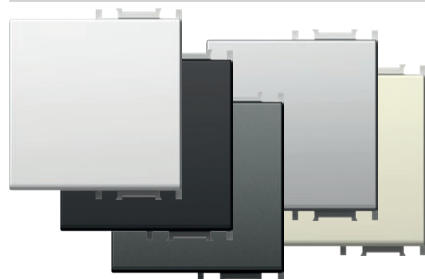

- TM12PW
- TM12SB
- TM12AT
- TM12ES
- TM12IW

- сменяем бутон 2M с носач за бутон
- за надграждане на ключ или бутон от размер 1M към размер 2M
- в съответствие с EN 60669-1

BUTTON 2M

- replaceable button 2M with button carrier
- to upgrade switch or push button from size 1M to size 2M
- in accordance with EN 60669-1



БУТОН 2M С ИНДИКАТОР

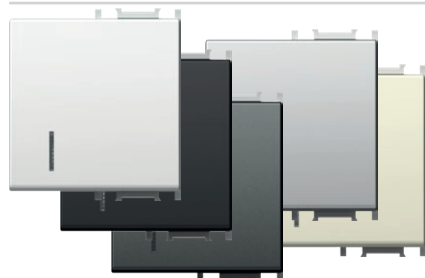

- TM12PWIN
- TM12SBIN
- TM12ATIN
- TM12ESIN
- TM12IWIN

- сменяем бутон 2M с носач за бутон
- за надграждане на ключ или бутон от размер 1M към размер 2M
- в съответствие с EN 60669-1

BUTTON 2M INDICATOR

- replaceable button 2M with button carrier
- to upgrade switch or push button from size 1M to size 2M
- in accordance with EN 60669-1



БУТОН 2М С ПАНЕЛ С НАДПИС

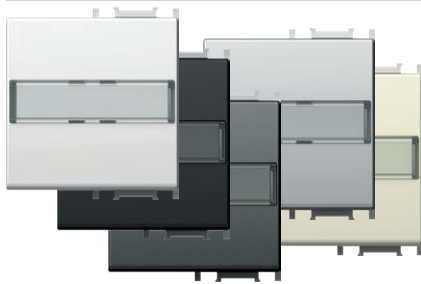

- TM13PWIL
- TM13SBIL
- TM13ATIL
- TM13ESIL
- TM13IWIL

- сменяем бутон 2М с носач за бутон
 - за надграждане на ключ или бутон
 от размер 1М към размер 2М
 - в съответствие с EN 60669-1

BUTTON 2M WITH INSCRIPTION PLATE
 - replaceable button 2M with button carrier
 - to upgrade switch or push button
 from size 1M to size 2M
 - in accordance with EN 60669-1



БУТОН 1М 2POLE

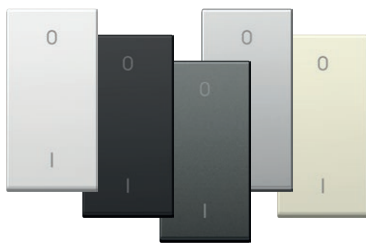

- TM15PW
- TM15SB
- TM15AT
- TM15ES
- TM15IW

- сменяем бутон 1М
 - само в комбинация с механизъм SM20
 - в съответствие с EN 60669-1

BUTTON 1M 2POLE
 - replaceable button 1M
 - only in combination with mechanism SM20
 - in accordance with EN 60669-1



КАПАЧЕ 1М

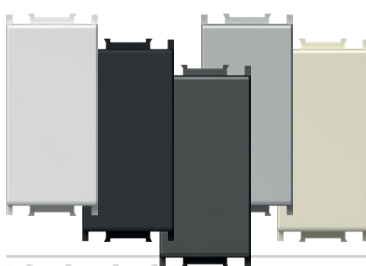

- TM21PW
- TM21SB
- TM21AT
- TM21ES
- TM21IW

- модулно капаче за покриване на неизползвани позиции
 - в съответствие с EN 60669-1

BLANK 1M
 - blank modul to fill up empty spaces
 - in accordance with EN 60669-1



КАПАЧЕ 2М



- TM22PW
- TM22SB
- TM22AT
- TM22ES
- TM22IW

- модулно капаче за покриване на неизползвани позиции
 - в съответствие с EN 60669-1

BLANK 2M
 - blank modul to fill up empty spaces
 - in accordance with EN 60669-1

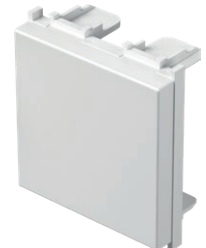

ИЗХОД ЗА КАБЕЛ 1М

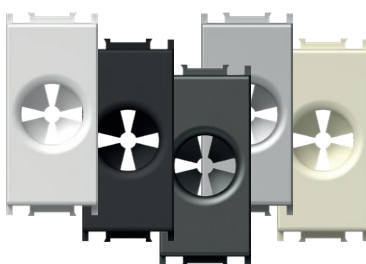

- TM31PW
- TM31SB
- TM31AT
- TM31ES
- TM31IW

- отвор за изход на кабел
 - в съответствие с EN-60669-1

CABLE OUTLET 1M
 - outlet for cable
 - in accordance with EN-60669-1



1M = 22,5 x 45
 2M = 45 x 45

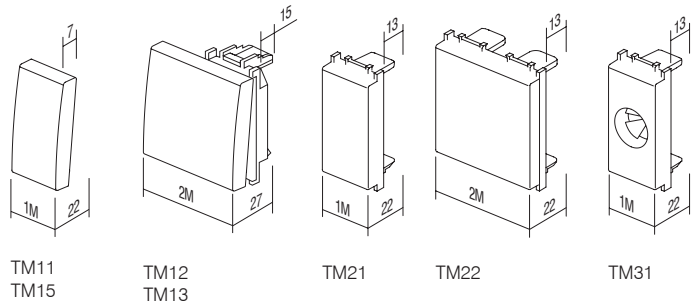

TM11
TM15

TM12
TM13

TM21

TM22

TM31

BUTTONS T M

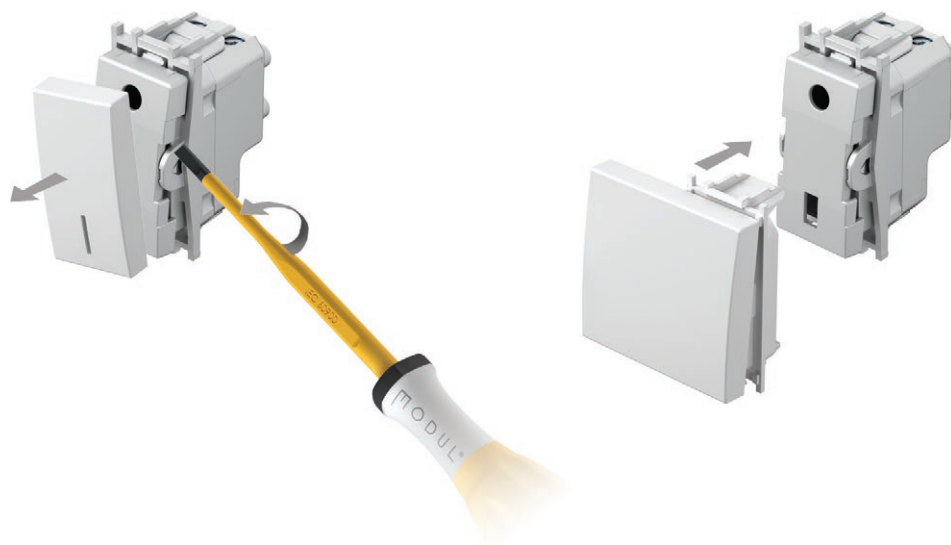

ЛАЗЕРЕН ПЕЧАТ ВЪРХУ БУТОНИ

- лазерно отпечатване на всякакви графични изображения
 върху маркирани места
 - налични стандартни символи, други – по заявка
LASER PRINT ON BUTTONS
 - laser print of any graphics on marked locations
 - standard symbols from stock, other on request

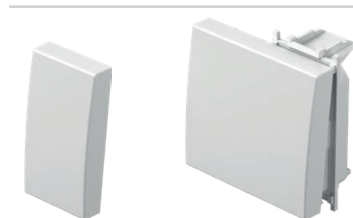

1M	2M
A	A D G
B	B E H
C	C F I

СИМВОЛИ

SYMBOLS

01	02	03	04	05	06	07	08	09	10	11	12	20	21	22	23
24	25	26	27	28	29	30	31	32	33	34	35	36	37	38	39
					OFF	ON					AC				
40	41	42	43	44	45	46	47	48							

СТАНДАРТНИ СИМВОЛИ

STANDARD SYMBOLS

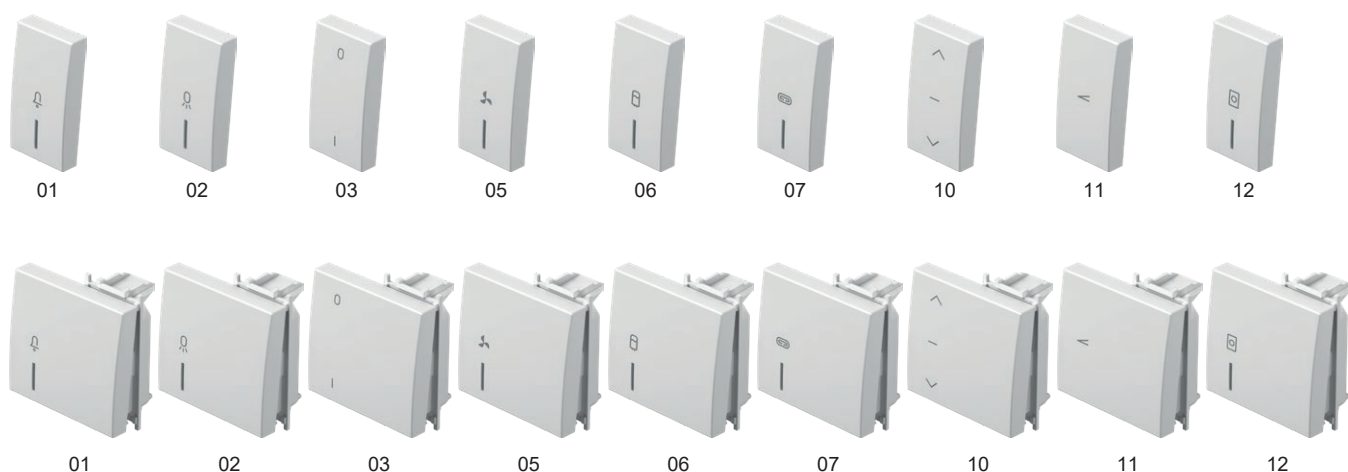

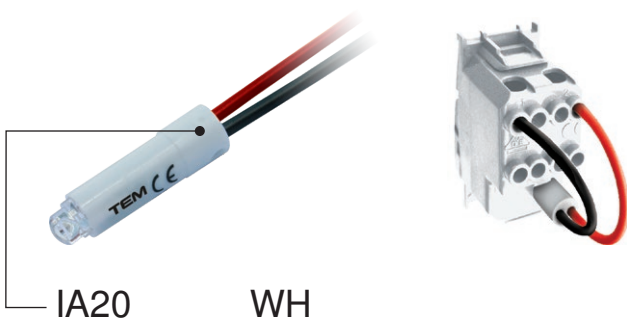

тип type	описание description	технически данни technical data	цвет colour
IA10	НЕОНОВА ЛАМПА NEON LAMP	230V~ 0,34W	<input type="checkbox"/> WH бял цвят white
IA20	СВЕТОДИОДНА ЛАМПА LED LAMP	230V~ AC/DC 0,40W	<input checked="" type="checkbox"/> BL син цвят blue
IA21	СВЕТОДИОДНА ЛАМПА LED LAMP	24V AC/DC 0,20W	<input checked="" type="checkbox"/> RD червен red
·	·	·	<input checked="" type="checkbox"/> GR зелен green
·	·	·	<input checked="" type="checkbox"/> OR оранжев orange

НЕОНОВА ЛАМПА 230 V~ 0,34 W

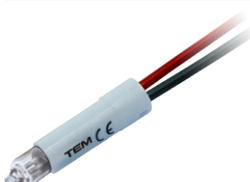

IA10OR

- за индикация, осветление или постоянно осветяване на ключа
- в комбинация с бутон с индикатор

NEON LAMP 230V~ 0,34W

- for indication, illumination or constant illumination of switch
- in combination with button with indicator

СВЕТОДИОДНА ЛАМПА 230 V AC/DC 0,40 W

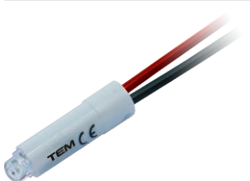

- IA20WH
- IA20GR
- IA20RD
- IA20BL

- за индикация, осветление или постоянно осветяване на ключа
- в комбинация с бутон с индикатор

LED LAMP 230V AC/DC 0,40W

- for indication, illumination or constant illumination of switch
- in combination with button with indicator

СВЕТОДИОДНА ЛАМПА 24 V AC/DC 0,20 W

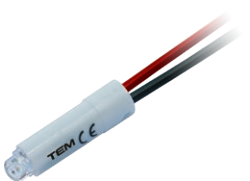

- IA21WH
- IA21RD

- за индикация, осветление или постоянно осветяване на ключа
- в комбинация с бутон с индикатор

LED LAMP 24V AC/DC 0,20W

- for indication, illumination or constant illumination of switch
- in combination with button with indicator

СВЕТОДИОДНА ЛАМПА 12 V AC/DC 0,10 W

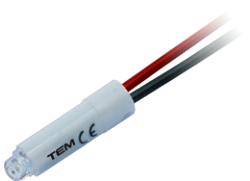

- IA22WH
- IA22RD

- за индикация, осветление или постоянно осветяване на ключа
- в комбинация с бутон с индикатор

LED LAMP 12V AC/DC 0,10W

- for indication, illumination or constant illumination of switch
- in combination with button with indicator

RC ВЕРИГА 250 V~

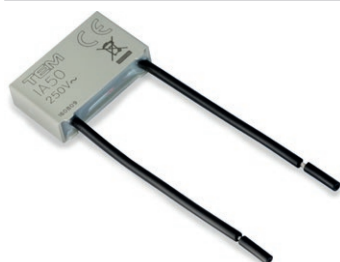

IA50

- RC верига за отстраняване на смущенията при работата на LED лампи
- възможно е успоредно свързване на няколко RC вериги с лампи
- 0,1 μF, 100 Ω, 250 V~

RC CIRCUIT 250V~

- RC circuit to eliminate disturbances in the operation of LED lamps
- parallel connections of more RC circuits with lamps are possible
- 0,1 μF, 100 Ω, 250V~

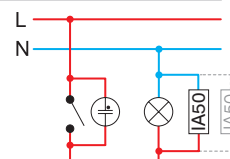

индикация /
Indication

* освещение /
Illumination

Постоянно освещение /
Constant illumination

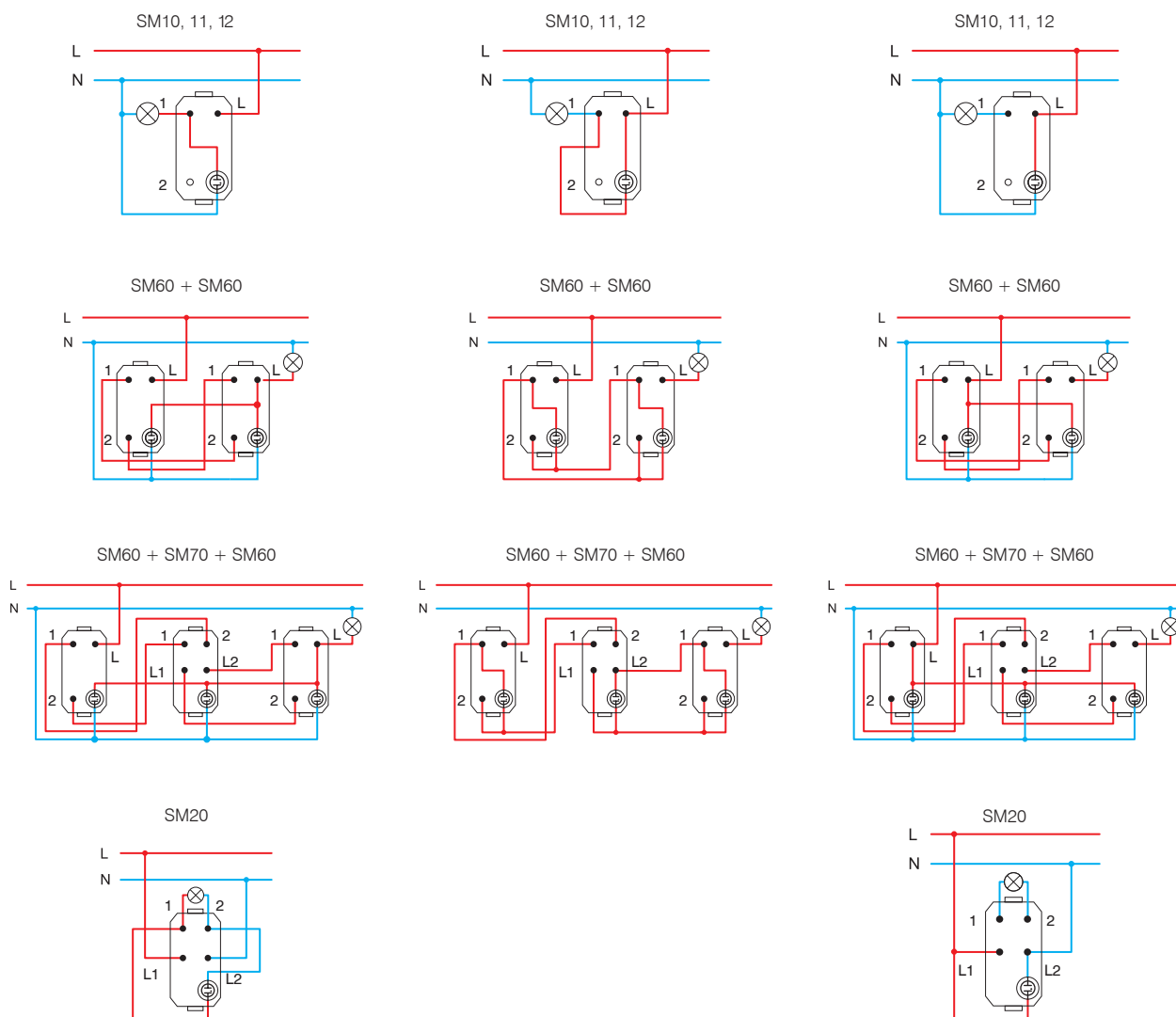

* връзките не са подходящи за енергоспестяващи крушки (CFL, LED) /
the connections are not suitable for energy-saving bulbs (CFL, LED)

1M = 22,5 x 45
2M = 45 x 45

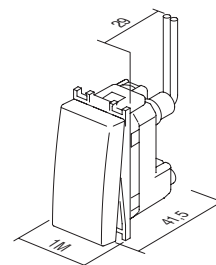

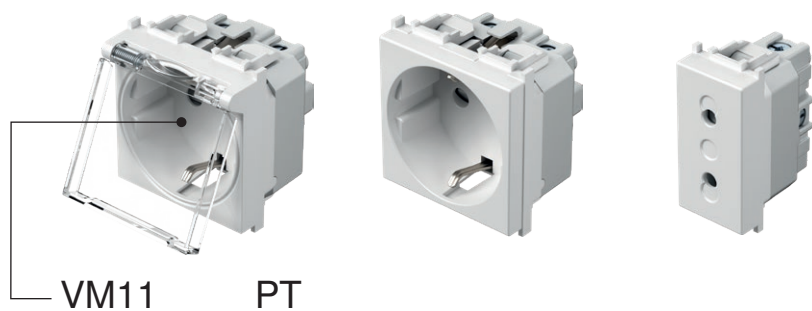

VM11

PT

тип type	описание description	технически данни technical data	размер size	цвет colour																		
VM10	КОНТАКТ ШУКО+KS SOCKET SCHUKO+KS	2P+E 16A 250V~	2M	<table border="0"> <tr> <td> PW снежнобял polar white</td> <td> PT бял + прозрачен white+transparent</td> <td> PP бял+бял white+white</td> </tr> </table>	PW снежнобял polar white	PT бял + прозрачен white+transparent	PP бял+бял white+white															
PW снежнобял polar white	PT бял + прозрачен white+transparent	PP бял+бял white+white																				
VM11	КОНТАКТ ШУКО+KS+КАПАК SOCKET SCHUKO+KS+COVER	2P+E 16A 250V~	2M	<table border="0"> <tr> <td> SB черен soft touch black</td> <td> BT черен + прозрачен soft touch black+transparent</td> <td> BB черен+черен soft touch black+black</td> </tr> </table>	SB черен soft touch black	BT черен + прозрачен soft touch black+transparent	BB черен+черен soft touch black+black															
SB черен soft touch black	BT черен + прозрачен soft touch black+transparent	BB черен+черен soft touch black+black																				
VM20	КОНТАКТ EURO+KS SOCKET EURO+KS	2P 10A 250V~	1M	<table border="0"> <tr> <td> AT антрацит anthracite</td> <td> AT антрацит + прозрачен anthracite+transparent</td> <td> AA антрацит+прозрачен anthracite+anthracite</td> </tr> <tr> <td> ES сребрист elox silver</td> <td> ST сребрист + прозрачен silver+transparent</td> <td> SS сребрист+сребрист silver+silver</td> </tr> <tr> <td> IW слонов кост ivory white</td> <td> IT слонов кост + прозрачен ivory+transparent</td> <td> II слонов кост+слонов кост ivory+ivory</td> </tr> <tr> <td> RD червен red</td> <td> RT червен + прозрачен red+transparent</td> <td> RR червен+червен red+red</td> </tr> <tr> <td> GR зелен green</td> <td> GT зелен + прозрачен green+transparent</td> <td> GG зелен+зелен green+green</td> </tr> <tr> <td> OR оранжев orange</td> <td> OT оранжев + прозрачен orange+transparent</td> <td> OO оранжев+оранжев orange+orange</td> </tr> </table>	AT антрацит anthracite	AT антрацит + прозрачен anthracite+transparent	AA антрацит+прозрачен anthracite+anthracite	ES сребрист elox silver	ST сребрист + прозрачен silver+transparent	SS сребрист+сребрист silver+silver	IW слонов кост ivory white	IT слонов кост + прозрачен ivory+transparent	II слонов кост+слонов кост ivory+ivory	RD червен red	RT червен + прозрачен red+transparent	RR червен+червен red+red	GR зелен green	GT зелен + прозрачен green+transparent	GG зелен+зелен green+green	OR оранжев orange	OT оранжев + прозрачен orange+transparent	OO оранжев+оранжев orange+orange
AT антрацит anthracite	AT антрацит + прозрачен anthracite+transparent	AA антрацит+прозрачен anthracite+anthracite																				
ES сребрист elox silver	ST сребрист + прозрачен silver+transparent	SS сребрист+сребрист silver+silver																				
IW слонов кост ivory white	IT слонов кост + прозрачен ivory+transparent	II слонов кост+слонов кост ivory+ivory																				
RD червен red	RT червен + прозрачен red+transparent	RR червен+червен red+red																				
GR зелен green	GT зелен + прозрачен green+transparent	GG зелен+зелен green+green																				
OR оранжев orange	OT оранжев + прозрачен orange+transparent	OO оранжев+оранжев orange+orange																				



КОНТАКТ ШУКО+KS 2P+E 16 A 250 V~ 2M

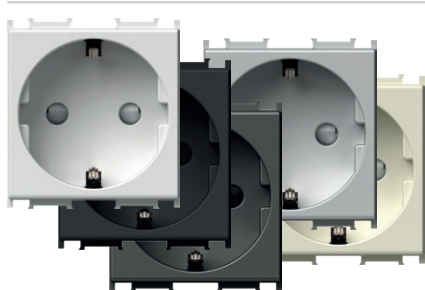

- VM10PW
- VM10SB
- VM10AT
- VM10ES
- VM10IW

- 2P+E шуко
- 16 A 250 V~, тип VM10
- в съответствие с IEC 60884-1, CEE7
- винтови контакти 1,5 - 2,5 mm²
- Вградена защита от допир на контакти

SOCKET SCHUKO+KS 2P+E 16A 250V~ 2M

- 2P+E schuko
- 16A 250V~, type VM10
- in accordance with IEC 60884-1, CEE7
- screw contacts 1.5-2.5 mm²
- shuttered live contacts



КОНТАКТ ШУКО+KS 2P+E 16 A 250 V~ 2M

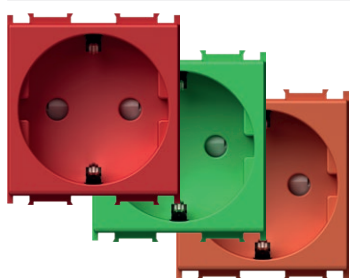

- VM10RD
- VM10GR
- VM10OR

- 2P+E шуко, 16 A 250 V~, тип VM10
- в съответствие с IEC 60884-1, CEE7
- винтови контакти 1,5 - 2,5 mm²
- Вградена защита от допир на контакти

SOCKET SCHUKO+KS 2P+E 16A 250V~ 2M

- 2P+E schuko
- 16A 250V~, type VM10
- in accordance with IEC 60884-1, CEE7
- screw contacts 1.5-2.5 mm²
- shuttered live contacts



КОНТАКТ ШУКО+KS+КАПАК 2P+E 16A 250V~ 2M

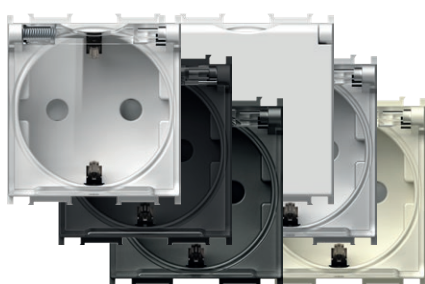

- VM11PT
- VM11BT
- VM11AT
- VM11ST
- VM11IT
- VM11PP

- 2P+E шуко+капак, 16A 250V~, тип VM11
- в съответствие с IEC 60884-1, CEE7
- винтови контакти 1,5 - 2,5 mm²
- Вградена защита от допир на контакти

SOCKET SCHUKO+KS+COVER

- 2P+E 16A 250V~ 2M
- 2P+E schuko+cover
- 16A 250V~, type VM11
- in accordance with IEC 60884-1, CEE7
- screw contacts 1.5-2.5 mm²
- shuttered live contacts



S O C K E T S V M

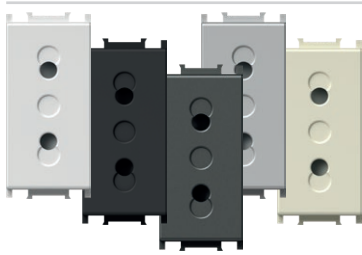

- VM20PW
- VM20SB
- VM20AT
- VM20ES
- VM20IW

КОТАКТ EURO+KS 2P 10 A 250 V~ 1M

- 2P Euro, 10 A 250 V~, тип VM20
- в съответствие с IEC 60884-1, CEE7
- винтови контакти 1,5 - 2,5 mm²
- Вградена защита от допир на контакти



SOCKET EURO+KS 2P 10A 250V~ 1M

- 2P Euro
- 10A 250V~, type VM20
- in accordance with IEC 60884-1, CEE7
- screw contacts 1.5-2.5 mm²
- shuttered live contacts

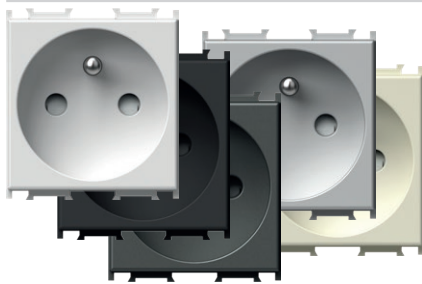

- VM40PW
- VM40SB
- VM40AT
- VM40ES
- VM40IW

ФРЕНСКИ КОТАКТ +KS 2P+E 16 A 250 V~ 2M

- 2P+E френски контакт, 16 A 250 V~, тип VM40
- в съответствие с IEC 60884-1, NF C 61-314, CEE7
- винтови контакти 1,5 - 2,5 mm²
- Вградена защита от допир на контакти



SOCKET FRENCH+KS 2P+E 16A 250V~ 2M

- 2P+E French
- 16A 250V~, type VM40
- in accordance with IEC 60884-1, NF C 61-314, CEE7
- screw contacts 1.5-2.5 mm²
- shuttered live contacts

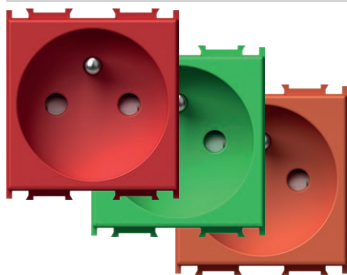

- VM40RD
- VM40GR
- VM40OR

ФРЕНСКИ КОТАКТ +KS 2P+E 16 A 250 V~ 2M

- 2P+E френски контакт, 16 A 250 V~, тип VM40
- в съответствие с IEC 60884-1, NF C 61-314, CEE7
- винтови контакти 1,5 - 2,5 mm²
- Вградена защита от допир на контакти



SOCKET FRENCH+KS 2P+E 16A 250V~ 2M

- 2P+E French
- 16A 250V~, type VM40
- in accordance with IEC 60884-1, NF C 61-314, CEE7
- screw contacts 1.5-2.5 mm²
- shuttered live contacts



- VM41PT
- VM41BT
- VM41AT
- VM41PP
- VM41ST
- VM41IT

ФРЕНСКИ КОТАКТ+KS+КАПАК 2P+E 16A 250V~ 2M

- 2P+E френски контакт+капак, 16A 250V~, тип VM41
- в съответствие с IEC 60884-1, NF C 61-314, CEE7
- винтови контакти 1,5 - 2,5 mm²
- Вградена защита от допир на контакти

SOCKET FRENCH+KS+COVER
2P+E 16A 250V~ 2M

- 2P+E French+cover
- 16A 250V~, type VM41
- in accordance with IEC 60884-1, NF C 61-314, CEE7
- screw contacts 1.5-2.5 mm²
- shuttered live contacts

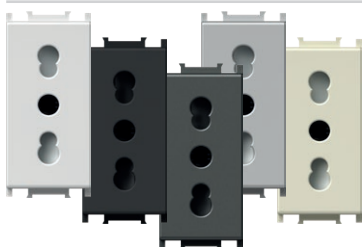

- VM30PW
- VM30SB
- VM30AT
- VM30ES
- VM30IW

ИТАЛИАНСКИ КОТАКТ P17/11+KS 2P+E 16 A 250 V~ 1M

- 2P+E Италиански контакт P17/11, 16 A 250 V~, тип VM30
- в съответствие с IEC 60884-1, CEI 23-50
- винтови контакти 1,5 - 2,5 mm²
- Вградена защита от допир на контакти



SOCKET ITALIAN P17/11+KS 2P+E 16A 250V~ 1M

- 2P+E Italian P17/11
- 16A 250V~, type VM30
- in accordance with IEC 60884-1, CEI 23-50
- screw contacts 1.5-2.5 mm²
- shuttered live contacts

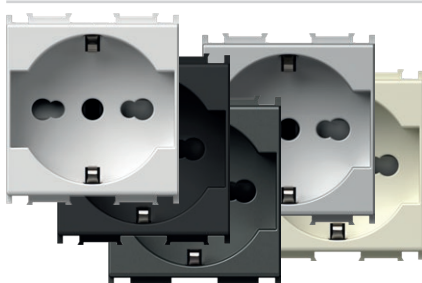

- VM31PW
- VM31SB
- VM31AT
- VM31ES
- VM31IW

КОТАКТ SCHUKO/ITA P17/11+KS 2P+E 16A 250V~ 2M

- 2P+E/контакт шуко/италиански P17/11, 16A 250V~, тип VM31
- в съответствие с IEC 60884-1, CEI 23-50
- винтови контакти 1,5 - 2,5 mm²
- Вградена защита от допир на контакти

SOCKET SCHUKO/ITA P17/11+KS
2P+E 16A 250V~ 2M

- 2P+E schuko/Italian P17/11
- 16A 250V~, type VM31
- in accordance with IEC 60884-1, CEI 23-50
- screw contacts 1.5-2.5 mm²
- shuttered live contacts

КОНТАКТ ШУКО/ИТА P30+KS 2P+E 16A 250V~ 2M

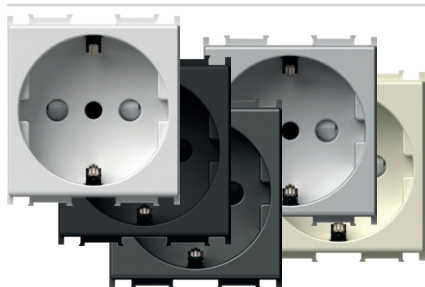

- VM32PW
- VM32SB
- VM32AT
- VM32ES
- VM32IW

- 2P+E/контакт шуко/италиански P30, 16A 250V~, тип VM32
- в съответствие с IEC 60884-1, CEI 23-50
- винтови контакти 1,5 - 2,5 mm²
- Вградена защита от допир на контакти



SOCKET SCHUKO/ITA P30+KS
2P+E 16A 250V~ 2M

- 2P+E schuko/Italian P30
- 16A 250V~, type VM32
- in accordance with IEC 60884-1, CEI 23-50
- screw contacts 1.5-2.5 mm²
- shuttered live contacts

ИТАЛИАНСКИ КОНТАКТ P11+KS 2P+E 10 A 250 V~ 1M

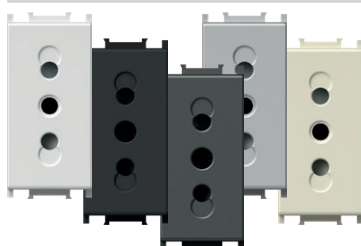

- VM33PW
- VM33SB
- VM33AT
- VM33ES
- VM33IW

- 2P+E Италиански контакт P11, 10 A 250 V~, тип VM33
- в съответствие с IEC 60884-1, CEI 23-50
- винтови контакти 1,5 - 2,5 mm²
- Вградена защита от допир на контакти



SOCKET ITALIAN P11+KS 2P+E 10A 250V~ 1M

- 2P+E Italian P11
- 10A 250V~, type VM33
- in accordance with IEC 60884-1, CEI 23-50
- screw contacts 1.5-2.5 mm²
- shuttered live contacts

КОНТАКТ EURO/АМЕРИКАНСКИ+KS 2P 16 A 250 V~ 1M

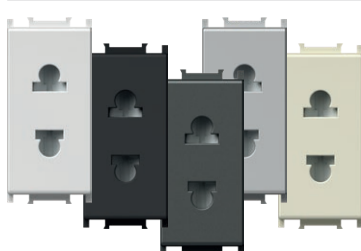

- VM21PW
- VM21SB
- VM21AT
- VM21ES
- VM21IW

- 2P Euro/американски, 16 A 250 V~, тип VM21
- винтови контакти 1,5 - 2,5 mm²
- Вградена защита от допир на контакти
- само за страни, които не са членки в ЕС



SOCKET EURO/AMERICAN+KS 2P 16A 250V~ 1M

- 2P Euro/American
- 16A 250V~, type VM21
- screw contacts 1.5-2.5 mm²
- shuttered live contacts
- only for countries not members of EU

БРИТАНСКИ КОНТАКТ BS 1363-2+KS 2P+E 13 A 250 V~ 2M

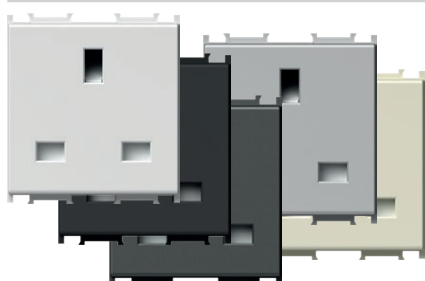

- VM52PW
- VM52SB
- VM52AT
- VM52ES
- VM52IW

- 2P+E британски контакт BS 1363-2, 13 A 250 V~, тип VM52
- в съответствие с BS 1363-2
- винтови контакти 1,5 - 4 mm²
- Вградена защита от допир на контакти

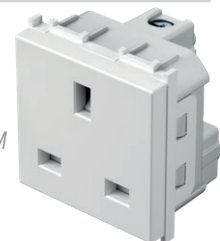

SOCKET BRITISH BS 1363-2+KS 2P+E 13A 250V~ 2M

- 2P+E British BS 1363-2
- 13A 250V~, type VM52
- in accordance with BS 1363-2
- screw contacts 1.5-4 mm²
- shuttered live contacts

КОНТАКТ МУЛТИСТАНДАРТНИЯТ+KS 2P+E 13A 250V~ 2M

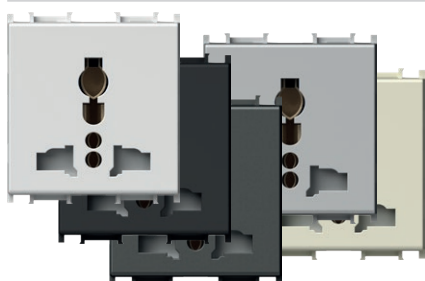

- VM55PW
- VM55SB
- VM55AT
- VM55ES
- VM55IW

- контакти чрез вкарване 1,5 - 2,5 mm²
- вградена защита на контактите

SOCKET MULTI-STANDARD+KS 2P+E 13A 250V~ 2M

- plug-in contacts 1.5-2.5 mm²
- built-in contact protection



УСТРОЙСТВО ЗА ЗАЩИТА СРЕЩУ ОТСКОЦИ НА НАПРЕЖЕНИЕТО MPE MINI 275 V/50 Hz



VM80

- успоредно свързване с първия контакт в реда
- клас на защита III
- U_c=275Vac, U_{oc}/I_{sc}=6kV/3kA, U_p<800V
- в съответствие с IEC 61643-1
- проводници 1,5 mm², IP20
- звук сигнал при прекъсване





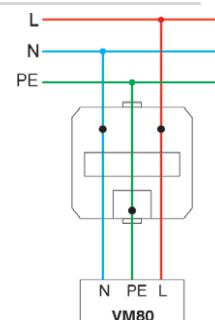





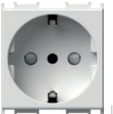

SURGE PROTECTOR MPE MINI 275V/50Hz

- parallel connection with the first socket in the row
- protection class III
- U_c=275Vac, U_{oc}/I_{sc}=6kV/3kA, U_p<800V
- in accordance with IEC 61643-1
- wires 1.5mm², IP20
- sound signal at breakdown







S O C K E T S V M

СЪОТВЕТВИЕ НА КОНТАКТИ И ЩЕПСЕЛИ
SOCKETS AND PLUGS MATCHING

КОНТАКТ / SOCKET									
ТИП НА ЩЕПСЕЛА / PLUG STYLE	VM10 VM11	VM20	VM30	VM33	VM31	VM32	VM40 VM41	VM21	VM55
Немски / German 	•				•	•			•
Френски / French 	•				•	•	•		•
Италиански / Italian S11 			•	•	•	•			•
Италиански / Italian S17 			•		•				•
euro 	•	•	•		•	•	•	•	•

СЪОТВЕТВИЕ НА КОНТАКТИ И ЩЕПСЕЛИ
SOCKETS AND PLUGS MATCHING

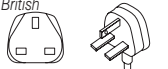
КОНТАКТ / SOCKET			
ТИП НА ЩЕПСЕЛА / PLUG STYLE	VM21	VM52	VM55
Американски / American 	•		•
Британски / British BS 1363-2 		•	•

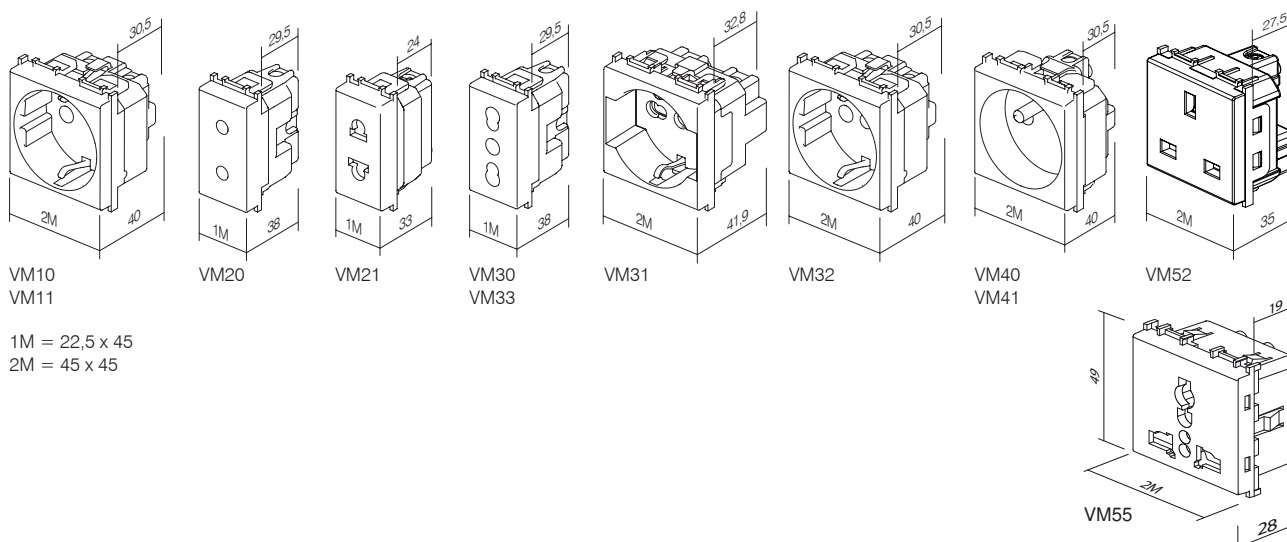



тип type	описание description	технически данни technical data	размер size	цвет colour
KM10	КОНЕКТОР ЗА ТВ ОСНОВЕН SOCKET TV BASIC	0dB	1M	<input type="checkbox"/> PW снежнобял цвят polar white
KM11	КОНЕКТОР ЗА ТВ КРАЕН SOCKET TV END-LINE	1dB	1M	<input checked="" type="checkbox"/> SB сензорен бутон черен soft touch black
KM12	КОНЕКТОР ЗА ТВ ПРЕХОДЕН SOCKET TV TROUGHPASS	10dB	1M	<input checked="" type="checkbox"/> AT антрацит anthracite
:	:	:	:	<input type="checkbox"/> ES сребрист elox silver
:	:	:	:	<input type="checkbox"/> IW слонова кост ivory white

КОНЕКТОР ЗА ТВ ОСНОВЕН 0 dB 1M

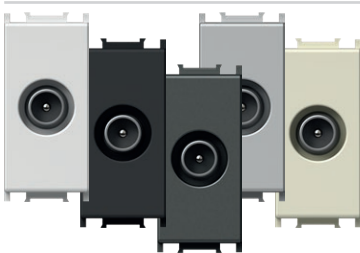

- KM10PW
- KM10SB
- KM10AT
- KM10ES
- KM10IW

- контакт за ТВ базов
- затихване 0 dB
- заден конектор – стандарт F
SOCKET TV BASIC 0dB 1M
- TV basic
- reduction 0dB
- back connector – F standard



КОНЕКТОР ЗА ТВ ОСНОВЕН 0 dB 2M

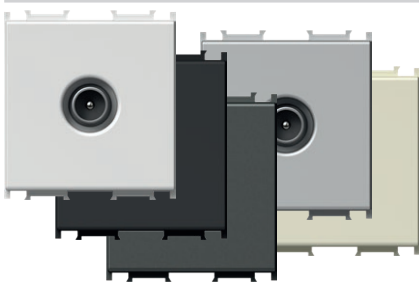

- KM20PW
- KM20SB
- KM20AT
- KM20ES
- KM20IW

- контакт за ТВ базов
- затихване 0 dB
- заден конектор – стандарт F
SOCKET TV BASIC 0dB 2M
- TV basic
- reduction 0dB
- back connector – F standard



КОНЕКТОР ЗА ТВ КРАЕН 1 dB 1M



- KM11PW
- KM11SB
- KM11AT
- KM11ES
- KM11IW

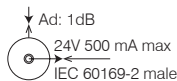

- контакт за ТВ краен
- честотен обхват 5÷2400 MHz
- затихване < 1 dB
- в съответствие с EN 50083-1
- винтови контакти
SOCKET TV END-LINE 1dB 1M
- TV end-line
- frequency range 5÷2400 MHz
- reduction < 1 dB
- in accordance with EN 50083-1
- screw contacts



КОНЕКТОР ЗА ТВ ПРЕХОДЕН 10 dB 1M

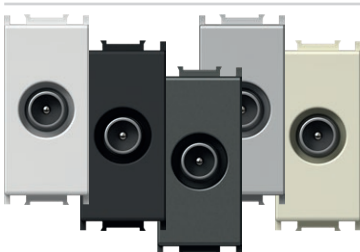

- KM12PW
- KM12SB
- KM12AT
- KM12ES
- KM12IW

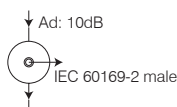

- преходник за ТВ сигнал
- честотен обхват 5÷2400 MHz
- затихване < 10 dB
- в съответствие с EN 50083-1
- винтови контакти
SOCKET TV TROUGHPASS 10dB 1M
- TV troughpass
- frequency range 5÷2400 MHz
- reduction < 10 dB
- in accordance with EN 50083-1
- screw contacts



КОНЕКТОР ЗА САТЕЛИТНА ТВ БАЗОВ 0 dB 1M



- KM15PW
- KM15SB
- KM15AT
- KM15ES
- KM15IW

- контакт за сателитна ТВ базов
 - затишване 0 dB
 - заден конектор – стандарт F
SOCKET SAT BASIC 0dB 1M
 - SAT basic
 - reduction 0dB
 - back connector – F standard



КОНЕКТОР ЗА САТЕЛИТНА ТВ БАЗОВ 0 dB 2M

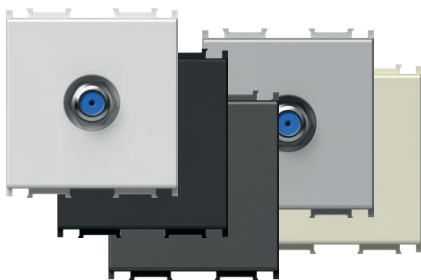

- KM24PW
- KM24SB
- KM24AT
- KM24ES
- KM24IW

- контакт за сателитна ТВ базов
 - затишване 0 dB
 - заден конектор – стандарт F
SOCKET SAT BASIC 0dB 2M
 - SAT basic
 - reduction 0dB
 - back connector – F standard



КОНЕКТОР ЗА САТЕЛИТНА ТВ КРАЕН 1 dB 1M

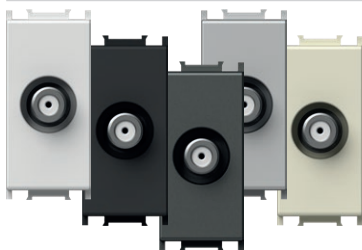

- KM16PW
- KM16SB
- KM16AT
- KM16ES
- KM16IW

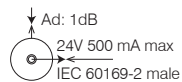

- конектор за сателитна ТВ краен
 - честотен обхват 5÷2400 MHz
 - затишване 1 dB
 - в съответствие с EN 50083-1
 - винтови контакти
SOCKET SAT END-LINE 1dB 1M
 - SAT end-line
 - frequency range 5÷2400 MHz
 - reduction < 1dB
 - in accordance with EN 50083-1
 - screw contacts



КОНЕКТОР ЗА РАДИО ОСНОВЕН 0 dB 1M



- KM19PW
- KM19SB
- KM19AT
- KM19ES
- KM19IW

- контакт за радио базов
 - затишване 0 dB
 - заден конектор – стандарт F
SOCKET R BASIC 0dB 1M
 - R basic
 - reduction 0dB
 - back connector – F standard



КОНЕКТОР ЗА РАДИО ОСНОВЕН 0 dB 2M

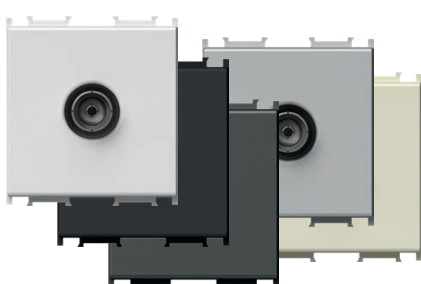

- KM29PW
- KM29SB
- KM29AT
- KM29ES
- KM29IW

- контакт за радио базов
 - затишване 0 dB
 - заден конектор – стандарт F
SOCKET R BASIC 0dB 2M
 - R basic
 - reduction 0dB
 - back connector – F standard



КОНЕКТОР ЗА САТЕЛИТНА ТВ КРАЕН 1 dB 2M

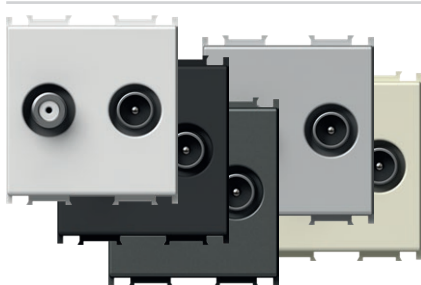

- KM25PW
- KM25SB
- KM25AT
- KM25ES
- KM25IW

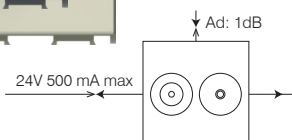

- контакт за сателитна ТВ краен
 - честотен обхват 5÷2400 MHz
 - затишване 1 dB
 - в съответствие с EN 50083-1
 - винтови контакти
SOCKET SAT-TV END-LINE 1dB 2M
 - SAT-TV end-line
 - frequency range 5÷2400 MHz
 - reduction < 1dB
 - in accordance with EN 50083-1
 - screw contacts



ПРИМЕРИ ЗА ОСНОВНО СВЪРЗВАНЕ

BASIC CONNECTION SAMPLES

индивидуално свързване
stand alone connection

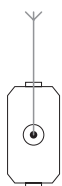

KM10
KM20
KM11
KM15
KM24
KM16
KM19
KM29
KM25

свързване тип звезда
star connection

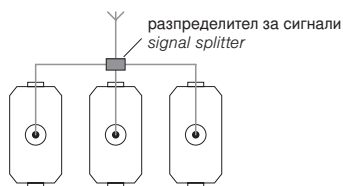

KM10
KM20
KM11
KM15
KM24
KM16
KM19
KM29
KM25

преходно свързване
throughpass connection

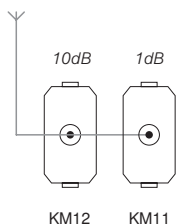

КОНТАКТ ЗА АУДИОСИГНАЛИ 2xRCA 1M



- KM22PW
- KM22SB
- KM22AT
- KM22ES
- KM22IW

- за аудиосигнали, с конектори 2x RCA
- свързване на кабела от задната страна чрез запояване

SOCKET AUDIO 2xRCA 1M

- audio 2x RCA
- soldering connection of cable at the back side



КОНЕКТОР ЗА ВИСОКОГОВОРТЕЛИ 1M



- KM23PW
- KM23SB
- KM23AT
- KM23ES
- KM23IW

- за аудиосигнали, 2x Ø4 mm
- за проводник за високоговорители, с щепсел тип банан Ø4 mm или плоски конектори
- свързване на кабела от задната страна чрез запояване

SOCKET AUDIO LOUDSPEAKERS 1M

- audio 2x Ø4mm
- to accommodate speaker wire, banana plug Ø4mm or spades
- soldering connection of cable at the back side



КОНЕКТОР ЗА ВИСОКОГОВОРТЕЛИ 2M



- KM26PW
- KM26SB
- KM26AT
- KM26ES
- KM26IW

- за аудиосигнали, 2x Ø4 mm
- за проводник за високоговорители, с щепсел тип банан Ø4 mm или плоски конектори
- свързване на кабела от задната страна чрез запояване

SOCKET AUDIO LOUDSPEAKERS 2M

- audio 2x Ø4mm
- to accommodate speaker wire, banana plug Ø4mm or spades
- soldering connection of cable at the back side



1M = 22,5 x 45
2M = 45 x 45

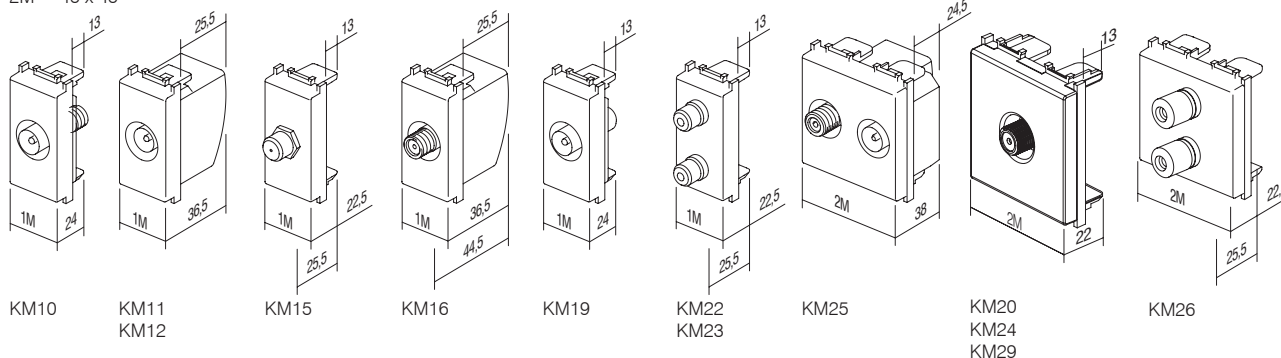

КОНЕКТОР ЗА ТЕЛЕФОН LT RJ11 6/4 1M



- KM30PW
- KM30SB
- KM30AT
- KM30ES
- KM30IW

- телефонен LT винтов
- RJ11 6/4
- в съответствие с IEC 60603-7
- винтови контакти

SOCKET TEL LT RJ11 6/4 1M

- TEL LT screw
- RJ11 6/4
- in accordance with IEC 60603-7
- screw contacts



КОНЕКТОР TEL BT SEC 6/6 1M

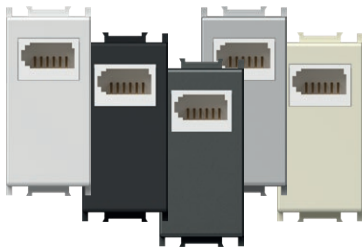

- KM31PW
- KM31SB
- KM31AT
- KM31ES
- KM31IW

- ТЕЛЕФОНЕН BT британски стандарт
- SEC вторичен 6/6
- в съответствие с BS 6312
- винтови контакти

SOCKET TEL BT SEC 6/6 1M

- TEL BT British standard
- SEC secondary 6/6
- in accordance with BS 6312
- screw contacts



КОНЕКТОР ЗА ТЕЛЕФОН KS RJ11 6/4 1M

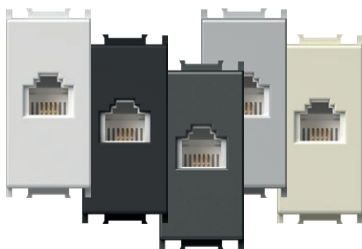

- KM36PW
- KM36SB
- KM36AT
- KM36ES
- KM36IW

- KS модулнен стандарт за закрепване
- RJ11 6/4
- в съответствие с IEC 60603-7

SOCKET TEL KS RJ11 6/4 1M

- KS keystone fixing standard
- RJ11 6/4
- in accordance with IEC 60603-7

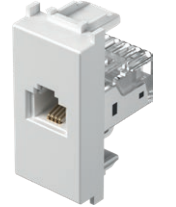

КОНЕКТОР CAT5e KS RJ45 8/8 1M

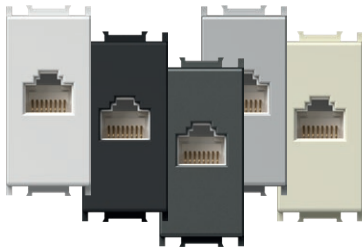

- KM37PW
- KM37SB
- KM37AT
- KM37ES
- KM37IW

- KS модулнен стандарт за закрепване
- CAT5e, RJ45 8/8
- в съответствие с IEC 60603-7

SOCKET CAT5e KS RJ45 8/8 1M

- KS keystone fixing standard
- CAT5e, RJ45 8/8
- in accordance with IEC 60603-7

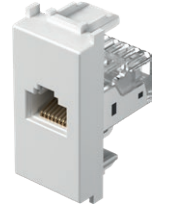

АДАПТЕР KS 1M

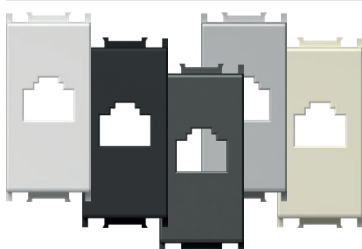

- KM35PW
- KM35SB
- KM35AT
- KM35ES
- KM35IW

- KS модулнен стандарт за закрепване
- AMP, Avaya, Brandrex, FMT, Mfico, Tyco, ...
- комуникационният модул не е включен в доставката

ADAPTER KS 1M

- KS keystone fixing standard
- AMP, Avaya, Brandrex, FMT, Mfico, Tyco, ...
- communication module not included



АДАПТЕР СЪС ЗАЩИТА ПРОТИВ ПРАХ 1M



- KM38PW
- KM38SB
- KM38AT
- KM38ES
- KM38IW

- KS модулнен стандарт за закрепване със защита против прах
- AMP, Avaya, Brandrex, FMT, Mfico, Tyco, ...
- комуникационният модул не е включен в доставката

ADAPTER KS WITH DUST PROTECTION 1M

- KS keystone fixing standard with dust protection
- AMP, Avaya, Brandrex, FMT, Mfico, Tyco, ...
- communication module not included



КОНЕКТОР CAT6 SCH KS RJ45 8/8 1M

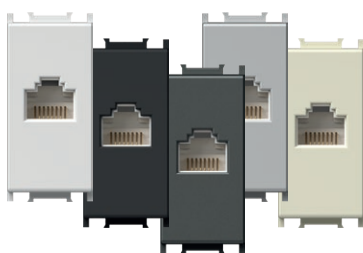

- KM39PW
- KM39SB
- KM39AT
- KM39ES
- KM39IW

- KS модулен стандарт за закрепване
- CAT6 UTP без нужда от инструменти, RJ45 8/8
- в съответствие с ISO/IEC 11801

SOCKET CAT6 SCH KS RJ45 8/8 1M

- KS keystone fixing standard
- CAT6 UTP toolless, RJ45 8/8
- in accordance with ISO/IEC 11801



УНИВЕРСАЛЕН АДАПТЕР KS 1M

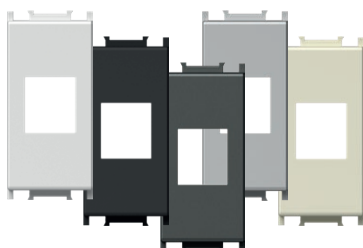

- KM50PW
- KM50SB
- KM50AT
- KM50ES
- KM50IW

- KS модулен стандарт за закрепване
- подходящ за HDMI, USB
- комуникационният модул не е включен в доставката

ADAPTER KS UNIVERSAL 1M

- KS keystone fixing standard
- suitable for HDMI, USB
- communication module not included



АДАПТЕР PD 1M

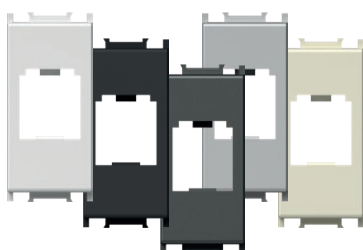

- KM40PW
- KM40SB
- KM40AT
- KM40ES
- KM40IW

- стандарт за закрепване PD Panduit Mini-COM
- комуникационният модул не е включен в доставката

ADAPTER PD 1M

- PD Panduit Mini-COM fixing standard
- communication module not included



АДАПТЕР PD СЪС ЗАЩИТА ПРОТИВ ПРАХ 1M



- KM43PW
- KM43SB
- KM43AT
- KM43ES
- KM43IW

- стандарт за закрепване PD Panduit Mini-COM със защита против прах
- комуникационният модул не е включен в доставката

ADAPTER PD WITH DUST PROTECTION 1M

- PD Panduit Mini-COM fixing standard with dust protection
- communication module not included



АДАПТЕР R&M 1M

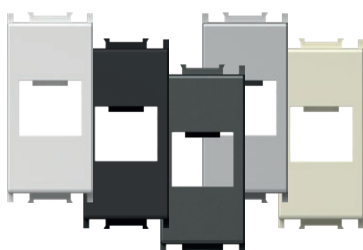

- KM46PW
- KM46SB
- KM46AT
- KM46ES
- KM46IW

- стандарт за закрепване R&M
- комуникационният модул не е включен в доставката

ADAPTER R&M 1M

- R&M fixing standard
- communication module not included



АДАПТЕР R&M CAT6A 1M

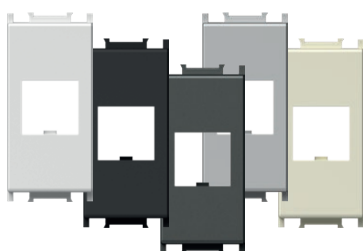

- KM52PW
- KM52SB
- KM52AT
- KM52ES
- KM52IW

- закрепване R&M за CAT6A
- комуникационният модул не е включен в доставката

ADAPTER R&M CAT6A 1M

- R&M fixing for CAT6A
- communication module not included





- KM47PW
- KM47SB
- KM47AT
- KM47ES
- KM47IW

АДАПТЕР R&M СЪС ЗАЩИТА ПРОТИВ ПРАХ 1M

- стандарт за закрепване R&M със защита против прах
- комуникационният модул не е включен в доставката

ADAPTER R&M WITH DUST PROTECTION 1M

- R&M fixing standard with dust protection
- communication module not included



- KM53PW
- KM53SB
- KM53AT
- KM53ES
- KM53IW

АДАПТЕР R&M CAT6A СЪС ЗАЩИТА ПРОТИВ ПРАХ 1M

- закрепване R&M за CAT6A със защита против прах
- комуникационният модул не е включен в доставката

ADAPTER R&M CAT6A WITH DUST PROTECTION 1M

- R&M fixing for CAT6A with dust protection
- communication module not included



АДАПТЕР LK 1M

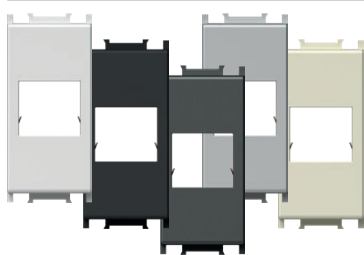

- KM45PW
- KM45SB
- KM45AT
- KM45ES
- KM45IW

- стандарт за закрепване LK LeoniKerpen eLine/BKS NewLine
 - комуникационният модул не е включен в доставката

ADAPTER LK 1M

- LK LeoniKerpen eLine / BKS NewLine fixing standard
 - communication module not included



АДАПТЕР NEXANS/SCHRACK 2M

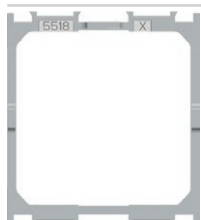

KA26

- адаптер за закрепване за Nexans LANmark и LANmark за Schrack размер 45x45 mm
 - модул Schrack 45x45 mm
 - подходящ за Schrack тип HSEMD02W2F
 - комуникационният модул не е включен в доставката

ADAPTER NEXANS/SCHRACK 2M

- fixing adapter for Nexans LANmark and Schrack module 45x45mm
 - suitable for Nexans type N423.540N
 - suitable for Schrack type HSEMD02W2F
 - communication module not included

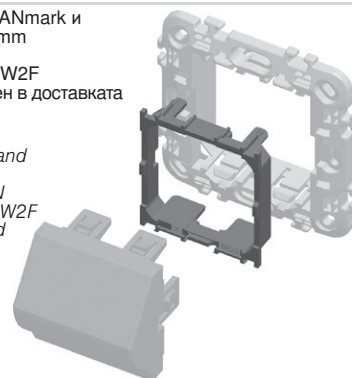

АДАПТЕР AT&T SYSTIMAX СЪС ЗАЩИТА ПРОТИВ ПРАХ 1M

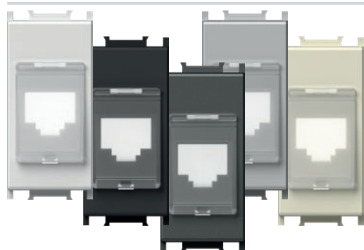

- KM48PW
- KM48SB
- KM48AT
- KM48ES
- KM48IW

- стандарт за закрепване AT&T Systimax със защита против прах
 - комуникационният модул не е включен в доставката

ADAPTER AT&T SYSTIMAX WITH DUST PROTECTION 1M

- AT&T Systimax fixing standard with dust protection
 - communication module not included



КОНЕКТОР USB ТИП А 1M



- KM51PW
- KM51SB
- KM51AT
- KM51ES
- KM51IW

- конектор тип А за USB 2.0
 - винтови контакти, стъпка 5 mm, 1,5 mm², 1x2P + 1x3P
 - свързване:
 Щифт 1 – VCC (+5V, червен проводник)
 Щифт 2 – Данни – (бял проводник)
 Щифт 3 – Данни + (зелен проводник)
 Щифт 4 – МАСА - (черен проводник)
 S – екранировка
 - в съответствие с Директива 2011/95/EC (RoHS2)

SOCKET USB TYPE A 1M

- USB 2.0 socket type A
 - screw contacts, raster 5 mm, 1,5 mm², 1x2P + 1x3P
 - wiring:
 PIN 1 – VCC (+5V, red wire)
 PIN 2 – Data - (white wire)
 PIN 3 – Data + (green wire)
 PIN 4 – GND - ground (black wire)
 S – shield
 - in accordance with directive 2011/95/EU (RoHS2)



1M = 22,5 x 45
 2M = 45 x 45

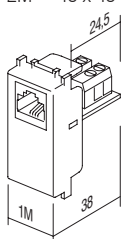

KM30

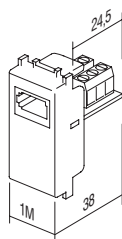

KM31

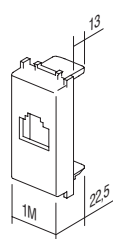

KM35
 KM38
 KM48

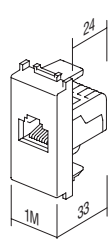

KM36
 KM37
 KM39

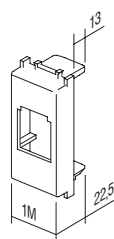

KM40
 KM43

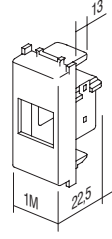

KM45

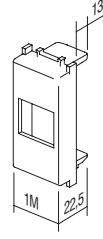

KM46
 KM47
 KM50
 KM52
 KM53

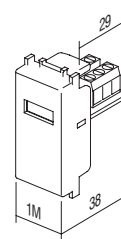

KM51



KA10

тип <i>type</i>	описание <i>description</i>	технически данни <i>technical data</i>
KA10	КОНЕКТОР KS CAT3 <i>CONNECTOR KS CAT3</i>	RJ11 6/4
KA11	КОНЕКТОР KS CAT5e <i>CONNECTOR KS CAT5e</i>	RJ45 8/8
KA12	КОНЕКТОР KS CAT5eS <i>CONNECTOR KS CAT5eS</i>	RJ45 8/8
⋮	⋮	⋮



KA10	<p>КОНЕКТОР KS CAT3 RJ11 6/4</p> <ul style="list-style-type: none"> - KS модулен стандарт за закрепване - CAT3, RJ11 6/4 - в съответствие с IEC 60603-7 <p><i>CONNECTOR KS CAT3 RJ11 6/4</i></p> <ul style="list-style-type: none"> - KS keystone fixing standard - CAT3, RJ11 6/4 - in accordance with IEC 60603-7
------	---------------------------------------------------------------------------------------------------------------------------------------------------------------------------------------------------------------------------------------------------------------------------------------------------------------------------------------------------------------------------------------



KA11	<p>КОНЕКТОР KS CAT5e RJ45 8/8</p> <ul style="list-style-type: none"> - KS модулен стандарт за закрепване - CAT5e, RJ45 8/8 - в съответствие с IEC 60603-7 <p><i>CONNECTOR KS CAT5e RJ45 8/8</i></p> <ul style="list-style-type: none"> - KS keystone fixing standard - CAT5e, RJ45 8/8 - in accordance with IEC 60603-7
------	-------------------------------------------------------------------------------------------------------------------------------------------------------------------------------------------------------------------------------------------------------------------------------------------------------------------------------------------------------------------------------------------



KA12	<p>КОНЕКТОР KS CAT5eS RJ45 8/8</p> <ul style="list-style-type: none"> - KS модулен стандарт за закрепване - CAT5eS, RJ45 8/8 - в съответствие с IEC 60603-7 <p><i>CONNECTOR KS CAT5eS RJ45 8/8</i></p> <ul style="list-style-type: none"> - KS keystone fixing standard - CAT5eS, RJ45 8/8 - in accordance with IEC 60603-7
------	-----------------------------------------------------------------------------------------------------------------------------------------------------------------------------------------------------------------------------------------------------------------------------------------------------------------------------------------------------------------------------------------------



KA15	<p>КОНЕКТОР KS CAT6 SCH RJ45 8/8</p> <ul style="list-style-type: none"> - KS модулен стандарт за закрепване - CAT6 UTP без нужда от инструменти, RJ45 8/8 - в съответствие с ISO/IEC 11801 <p><i>CONNECTOR KS CAT6 SCH RJ45 8/8</i></p> <ul style="list-style-type: none"> - KS keystone fixing standard - CAT6 UTP toolless, RJ45 8/8 - in accordance with ISO/IEC 11801
------	---------------------------------------------------------------------------------------------------------------------------------------------------------------------------------------------------------------------------------------------------------------------------------------------------------------------------------------------------------------------------------------------------------------------------------------------



KA16	<p>КОНЕКТОР KS CAT6S SCH RJ45 8/8</p> <ul style="list-style-type: none"> - KS модулен стандарт за закрепване - CAT6S STP без нужда от инструменти, RJ45 8/8 - в съответствие с ISO/IEC 11801 <p><i>CONNECTOR KS CAT6S SCH RJ45 8/8</i></p> <ul style="list-style-type: none"> - KS keystone fixing standard - CAT6S STP toolless, RJ45 8/8 - in accordance with ISO/IEC 11801
------	-------------------------------------------------------------------------------------------------------------------------------------------------------------------------------------------------------------------------------------------------------------------------------------------------------------------------------------------------------------------------------------------------------------------------------------------------



KA17	<p>КОНЕКТОР KS CAT6a SCH RJ45 8/8</p> <ul style="list-style-type: none"> - KS модулен стандарт за закрепване - CAT6a STP без нужда от инструменти, RJ45 8/8 - в съответствие с ISO/IEC 11801 <p><i>CONNECTOR KS CAT6a SCH RJ45 8/8</i></p> <ul style="list-style-type: none"> - KS keystone fixing standard - CAT6a STP toolless, RJ45 8/8 - in accordance with ISO/IEC 11801
------	-------------------------------------------------------------------------------------------------------------------------------------------------------------------------------------------------------------------------------------------------------------------------------------------------------------------------------------------------------------------------------------------------------------------------------------------------



KA18

КОНЕКТОР SLIM KS CAT6S SCH RJ45 8/8

- KS модулен стандарт за закрепване
- компактно изпълнение
- CAT6S STP без нужда от инструменти, RJ45 8/8
- в съответствие с ISO/IEC 11801
- също така е подходящ за двоен адаптор KE46

CONNECTOR SLIM KS CAT6S SCH RJ45 8/8

- *KS keystone fixing standard*
- *slim style*
- *CAT6S STP toolless, RJ45 8/8*
- *in accordance with ISO/IEC 11801*
- *suitable also for KE46 double adapter*



KA27

КОНЕКТОР KS HDMI

- KS модулен стандарт за закрепване
- само в комбинация с адаптер KM50
- HDMI/HDMI

CONNECTOR KS HDMI

- *KS keystone fixing standard*
- *only in combination with adapter KM50*
- *HDMI/HDMI*



KA28

КАБЕЛ KS HDMI

- KS модулен стандарт за закрепване
- само в комбинация с адаптер KM50
- HDMI/HDMI

CABLE KS HDMI

- *KS keystone fixing standard*
- *only in combination with adapter KM50*
- *HDMI/HDMI*



EM31



PW



тип type	описание description	технически данни technical data	размер size	цвет colour
EM12	ДИМЕР, ВЪРТЯЩ ТИП/ДВУПОСОЧЕН, RL 300W АКТИВЕН/ИНДУКТИВЕН ТОВАР <i>DIMMER ROTATIVE 2WAY</i>		1M	<input type="checkbox"/> PW снежнобял цвят <i>polar white</i> <input type="checkbox"/> SB сензорен бутон, черен <i>soft touch black</i> <input type="checkbox"/> AT антрацит <i>anthracite</i> <input type="checkbox"/> ES сребрист <i>elox silver</i> <input type="checkbox"/> IW слонова кост <i>ivory white</i>
EM23	ДИМЕР, ВГРАДЕН, ЗА АКТИВЕН ТОВАР <i>DIMMER INBOX</i>	R (250 W), (RC,RL 200VA)	/	<input type="checkbox"/> BL син цвят <i>blue</i> <input type="checkbox"/> RD червен <i>red</i> <input type="checkbox"/> GR зелен <i>green</i> <input type="checkbox"/> OR оранжев <i>orange</i> <input type="checkbox"/> RG червен/зелен <i>red/green</i>
.
.

ДИМЕР, ВЪРТЯЩ ТИП/ДВУПОСОЧЕН, АКТИВЕН/ИНДУКТИВЕН ТОВАР 300 W 1M



- EM12PW
- EM12SB
- EM12AT
- EM12ES
- EM12IW

- управление чрез завъртане, с двупосочен ключ
- активен/индуктивен товар, 40 W – 300 W
- захранващо напрежение 230 V~ 50 Hz
- възможна е комбинация с двупосочен ключ
- допуска се инсталиране на няколко устройства заедно в една конзола само ако общият им максимален товар не превишава максималната мощност на един димер
- една верига позволява използване само на един димер
- без вграден предпазител – трябва да се използва външен предпазител
- в съответствие с EN 60669-1
- винтови контакти – 1,5-2,5 mm²
- интегрирана светодиодна индикация за нивото на димиране

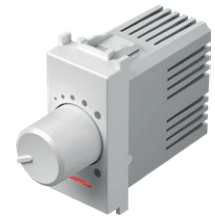

DIMMER ROTATIVE/2WAY RL 300W 1M

- rotation control with 2-way switch
- load RL, 40W - 300W
- supply voltage 230V~ 50Hz
- 2-way switch combination is possible
- installing several devices together in one box is only permitted if their total maximum load does not exceed the maximum power of a single dimmer
- one circuit allows the use of only one dimmer
- no built-in fuse – external fuse must be used
- in accordance with EN 60669-1
- screw contacts - 1.5-2.5mm²
- integrated LED indication of dimming level

ДИМЕР, ВЪРТЯЩ ТИП/ДВУПОСОЧЕН, ЗА СВЕТОДИОДНО ОСВЕТЛЕНИЕ 60 W 1M



- EM13PW
- EM13SB
- EM13AT
- EM13ES
- EM13IW

- управление чрез завъртане, с двупосочен ключ
- товар: светодиодно осветление, 0 – 60 W (макс. 6 димируеми светодиодни лампи)
GLS, 0 – 60 W
- захранващо напрежение 230 V~ 50 Hz
- възможна е комбинация с двупосочен ключ
- допуска се инсталиране на няколко устройства заедно в една конзола само ако общият им максимален товар не превишава максималната мощност на един димер
- една верига позволява използване само на един димер
- без вграден предпазител – трябва да се използва външен предпазител
- в съответствие с IEC60669-2-1
- винтови контакти – 1,5-2,5 mm²

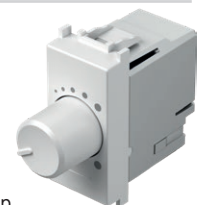

DIMMER ROTATIVE/2WAY LED 60W 1M

- rotation control with 2-way switch
- loads: LED, 0 – 60W (max. 6 dimmable LED lamps)
GLS, 0 – 60W
- supply voltage 230V~ 50Hz
- 2-way switch combination is possible
- installing several devices together in one box is only permitted if their total maximum load does not exceed the maximum power of a single dimmer
- one circuit allows the use of only one dimmer
- no built-in fuse – external fuse must be used
- in accordance with IEC60669-2-1
- screw contacts - 1.5-2.5mm²



- EM14PW
- EM14SB
- EM14AT
- EM14ES
- EM14IW

ДИМЕР, ВЪРТЯЩ ТИП/ДВУПОСОЧЕН, ЗА СВЕТОДИОДНО ОСВЕТЛЕНИЕ 180W 1M

- управление чрез завъртане, с двупосочен ключ
- товар: светодиодно осветление, 0 – 180 W (макс. 20 димируеми светодиодни лампи) GLS, 0 – 180 W
- захранващо напрежение 230 V~ 50 Hz
- възможна е комбинация с двупосочен ключ
- допуска се инсталиране на няколко устройства заедно в една конзола само ако общият им максимален товар не превишава максималната мощност на един димер
- една верига позволява използване само на един димер
- без вграден предпазител – трябва да се използва външен предпазител
- в съответствие с IEC60669-2-1
- винтови контакти – 1,5-2,5 mm²



DIMMER ROTATIVE/2WAY LED 180W 1M

- rotation control with 2-way switch
- loads:
 - LED, 0 – 180W (max. 20 dimmable LED lamps)
 - GLS, 0 – 180W
- supply voltage 230V~ 50Hz
- 2-way switch combination is possible
- installing several devices together in one box is only permitted if their total maximum load does not exceed the maximum power of a single dimmer
- one circuit allows the use of only one dimmer
- no built-in fuse – external fuse must be used
- in accordance with IEC60669-2-1
- screw contacts - 1.5-2.5mm²



- EM15PW
- EM15SB
- EM15AT
- EM15ES
- EM15IW

ДИМЕР, ВЪРТЯЩ ТИП, R 250W 1M

- управление чрез завъртане, без ключ
- активен товар, 40 W – 250 W
- захранващо напрежение 230 V~ 50 Hz
- не е възможна комбинация с двупосочен ключ
- не се допуска комбинация с допълнителни димери
- в съответствие с EN 60669-1
- винтови контакти 1,5 - 2,5 mm²
- светодиодна индикация



DIMMER ROTATIVE R 250W 1M

- rotation control without switch
- load R, 40W - 250W
- supply voltage 230V~ 50Hz
- 2-way switch combination is not possible
- more dimmers combination is not allowed
- in accordance with EN 60669-1
- screw contacts 1.5-2.5mm²
- LED indication



- EM16PW
- EM16SB
- EM16AT
- EM16ES
- EM16IW

1 – 10 V ДИМЕР, ВЪРТЯЩ ТИП, ДВУПОСОЧЕН

- номинално работно напрежение: 10 V DC
- минимално работно напрежение: 0,7 V DC
- диапазон на димиране: 0,7% – 100% (в зависимост от драйвера и товара)
- минимален понорен ток: 0,1 mA
- максимален понорен ток: 120 mA
- максимална консумация: 0,35 W
- защита срещу свръхнапрежение: 15,8 V DC до 250 mA (несменяема)
- най-голям пулсов ток: 3 A DC
- вид товар: 0 – 10 V, 1 – 10 V и PWM
- тип на ключа: механичен: натисни вкл/изключи
- проводник на нустралата: не е необходим
- номинално работно напрежение: 100 – 240 V AC, 50 – 60 Hz
- максимален моментен ток: 10 A
- максимален работен ток: 8 A
- максимално натоварване (при 230 VAC): 1800 VA (1800 x pf = max. W)
- изолационно съпротивление: > 100 MΩ при 250 V AC
- защита срещу свръхнапрежение и късо съединение: 10 A, 350 V AC (несменяема)
- ъгъл на ротация: 270° ± 5°
- работна температура: -5 до 40° C
- температура на съхранение: -30 до 80° C
- максимална температура на рамката: 65° C
- максимална влажност: 90% (без кондензация)
- EMC и имунност: CISPR 15(2008), IEC 61547
- LVD: IEC 60669-1:2017, IEC 60669-2-1:2015



1-10 V DIMMER ROTARY TOGGLE

- nominal operating voltage: 10 VDC
- minimum operating voltage: 0.7 VDC
- dimming range: 0.7% – 100% (depending on power supply and loads)
- minimum sink current: 0.1 mA
- maximum sink current: 120 mA
- maximum consumption: 0.35 W
- surge protection: 15.8 VDC up to 250 mA (not replaceable)
- maximum pulse current: 3 ADC
- load types: 0-10 V, 1–10 V and PWM
- switch type: mechanical: push on/off
- zero cable: not required
- nominal operating voltage: 100–240 VAC, 50–60 Hz
- maximum instantaneous current: 10 A
- maximum operating current: 8 A
- maximum load (at 230 VAC): 1800 VA (1800 x pf = max. W)
- isolation resistance: > 100 MΩ at 250 VAC
- surge protection and Short-circuit protection: 10 A, 350 VAC (not replaceable)
- rotation angle: 270° ± 5°
- operating temperature: -5 to 40°C
- storing temperature: -30 to 80°C
- maximum housing temperature: 65°C
- maximum humidity: 90% (no condensation)
- EMC & immunity: CISPR 15(2008), IEC 61547
- LVD: IEC 60669-1:2017, IEC 60669-2-1:2015

**ДИМЕР, ВГРАДЕН, ЗА АКТИВЕН ТОВАР (250 W),
(АКТИВЕН/КАПАЦИТИВЕН, АКТИВЕН/ИНДУКТИВЕН ТОВАР 200 VA)**



EM23

- вграден, управлява се от външен бутон
- активен/индуктивен/капацитивен товар 15-250 W или 15-200 VA
- захранващо напрежение 230 V~ 50 Hz
- възможни са комбинации от няколко бутона
- не се допуска комбинация с допълнителни димери
- памет за интензивността на осветлението
- функция за плавно стартиране/спиране
- »leading edge«
- в съответствие с EN60669, EN60950, EN 61000, ETSI EN 300 220-1, ETSI EN 300 220-2
- винтови контакти за проводници 2,5 mm²

DIMMER INBOX R (250 W), (RC, RL 200 VA)

- *inbox, controlled by external push button*
- *load RLC 15-250W or 15-200 VA*
- *supply voltage 230V~ 50Hz*
- *several push-buttons combinations are possible*
- *more dimmers combination is not allowed*
- *light intensity memory*
- *soft start/stop function*
- *»leading edge«*
- *in accordance with EN60669, EN60950, EN 61000, ETSI EN 300 220-1, ETSI EN 300 220-2*
- *screw contacts to wires 2,5 mm²*

ДИМЕРНО УСТРОЙСТВО ЗА СВЕТОДИОДИ 250W



EM18

- вградена кутия, управлява се външно чрез бутон
- за индуктивен и капацитивен товар
- захранващо напрежение 230 V~ 50 Hz
- възможни са няколко комбинации с бутони
- функция за запаметяване на последната настройка, освен при прекъсване на захранването
- функция за плавен старт/стоп
- контрол на минималния интензитет
- само един димер за стена кутия
- само за употреба на закрито
- в съответствие с EN 60669-1 и EN 60669-2-1

DIMMER INBOX LED 250W

- *inbox, controlled by external push button*
- *for leading or trailing edge*
- *supply voltage 230V~ 50Hz*
- *several push-buttons combinations is possible*
- *memory function of the last setting, except in the case of a power failure*
- *soft start / stop function*
- *minimum intensity control*
- *only one dimmer per wall box*
- *only for indoor usage*
- *in accordance with EN 60669-1 and EN 60669-2-1*

ДИМЕРНО УСТРОЙСТВО ЗА СВЕТОДИОДИ, ПОСТОЯНЕН ТОК 96 W



EM19

- вградена кутия, управлява се външно чрез бутон
- за употреба със светодиодни драйвери с постоянно напрежение и някои светодиодни драйвери с постоянен ток, 9 – 48 V DC, макс. 96 W (подходящо и за светодиодни ленти)
- не е подходящо за употреба при индуктивен товар
- възможни са комбинации от няколко бутона и няколко димера
- функция за запаметяване на последната настройка, освен при прекъсване на захранването
- функция за плавен старт/стоп
- само един димер за стена кутия
- само за употреба на закрито

DIMMER INBOX DC LED 96W

- *inbox, controlled by external push button*
- *for use with constant voltage LED drivers and some constant current LED drivers, 9-48V DC, max 96W (also for LED strips)*
- *not for use with inductive loads*
- *several push-buttons combinations and several dimmers is possible*
- *memory function of the last setting, except in the case of a power failure*
- *soft start / stop function*
- *only one dimmer per wall box*
- *only for indoor usage*

EM15 (40÷250W)

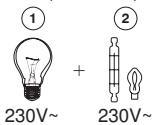

EM12 (40÷300W)

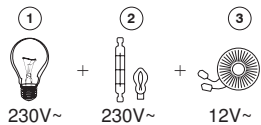

EM13 (0÷60W), EM14 (0÷180W),
EM23 (15÷250W, 15÷200VA),
EM18 (2÷250VA (3=10÷250VA), 2÷250W)

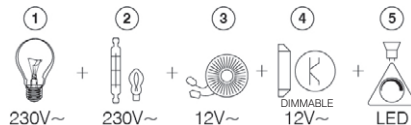

- 1 – лампа с нажежаема жичка / incandescent lamp
- 2 – халогенна лампа / halogen lamp
- 3 – класически трансформатор / classical transformer
- 4 – Димиращ електронен трансформатор / dimmable electronic transformer
- 5 – димируема светодиодна лампа / dimmable LED lamp

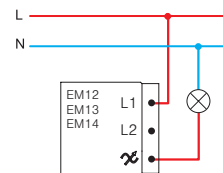
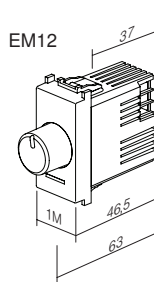
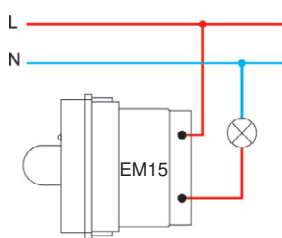
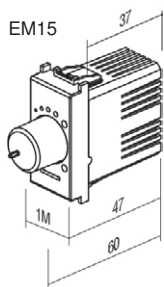

EM23

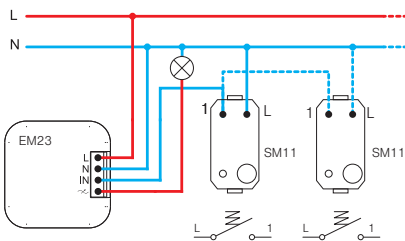
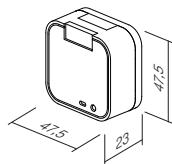

EM13, EM14

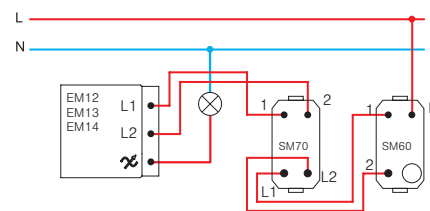
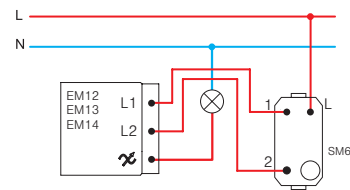
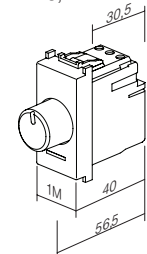

EM18

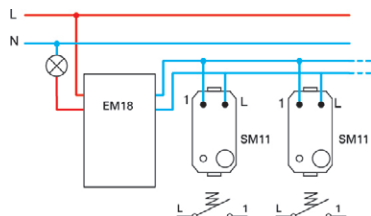
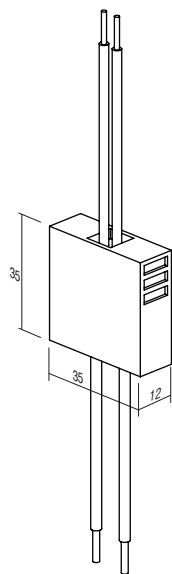

EM19

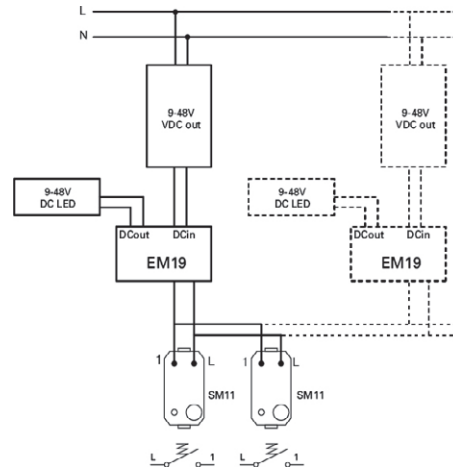
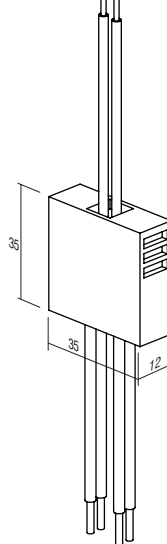

ВНИМАНИЕ!

Ако няколко димера са свързани в една конзола, намалете допустимата обща максимална мощност с 10 % за всеки димер.

ATTENTION!

If more dimmers are connected in one box reduce maximum common power for 10% for each dimmer.

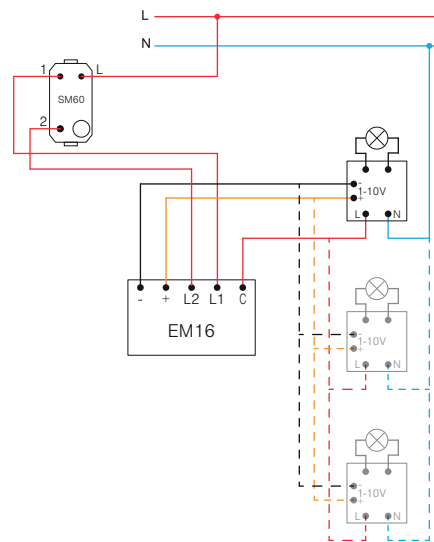
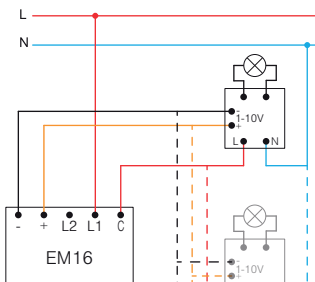
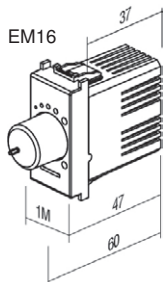
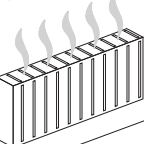



- EM25PW
- EM25SB
- EM25AT
- EM25ES
- EM25IW

TOUCH EM25 е управляван от микропроцесор електронен димер за осветление. Той служи за ключ и димер за лампи, позволяващи димиране, и за някои видове лампи, не позволяващи димиране. Интегрираният микропроцесор автоматично идентифицира типа на лампата и напаса работния режим. Благодарение на интегрираната функция за запаметяване се запомня нивото на димиране след изключване. Функцията за плавно стартиране/спиране удължава експлоатационния живот на лампите. Вградено в бутон елегантно светодиодно осветление дава възможности за голям брой различни цветове и нива на осветеност. Като опция е възможно свързване на максимално 5 допълнителни управляващи устройства EM26 («подчинени устройства») към EM25.

TOUCH EM25 is microprocessor controlled electronic light dimmer. It serves as switch and dimmer for dimmable and some of non-dimmable lamps. Integrated microprocessor automatically identifies the type of lamp and adjusts the operating mode. It remembers the level of dimming after switching off due to integrated memory function. Soft-start function extends the lamp service life. In button integrated elegant LED illumination enables many different colours and intensity levels. Optionally one can connect up to 5 additional control tasters EM26 («slave»).

КЛЮЧ УНИВЕРСАЛЕН ДИМЕР ЗА АКТИВЕН ИНДУКТИВЕН КАПАЦИТИВЕН ТОВАР 0-300 W 2M

- универсален електронен димер за включване, изключване и димиране на всички лампи, позволяващи димиране (класически, халогенни, светодиодни, газоразрядни...) и някои видове лампи, не позволяващи димиране
- автоматично определяне на типа на лампата и регулиране на работния режим
- намалена консумация на енергия
- функцията за плавно стартиране/спиране удължава живота на лампите
- управление чрез вградени микроключета
- съдържа функция за запаметяване – запомня силата на осветлението в момента на изключване
- допълнително може да се свържат до пет (5) устройства за управление EM26
- не е възможно свързване с двупосочен ключ
- вградена защита против късо съединение, прегряване и претоварване
- запазващо напрежение 230 V ~ 50 Hz
- елегантно светодиодно осветление, регулиране на цвета и яркостта
- замяна на обикновен ключ е възможно при двупроводно свързване (1)
- в съответствие с EN 60669-1 и EN 60669-2-1
- винтови контакти за проводници 1,5 mm² (макс. въртящ момент за притягане 0,4 Nm)



SWITCH / DIMMER UNIVERSAL RLC 0-300W 2M

- universal electronic dimmer for ON/OFF switching and dimming of all dimmable lamps (classical, halogen, LED, CFL, ...) and some non-dimmable lamps
- automatic detection of lamp type and adjustment of operating mode
- reduction of energy consumption
- soft start function extends life of lamps
- controlled by build-in micro switches
- memory function included – memorizes brightness on turn-off
- up to five (5) additional control units EM26 can be connected
- connection with 2-way switch is not possible
- build-in short-circuit, overheating and overload protection
- supply voltage 230V ~ 50Hz
- elegant LED illumination, adjustable colour and brightness
- replacement of classical switch is possible at two-wire connection⁽¹⁾
- full functionality is achieved at three-wire connection⁽²⁾
- in accordance with EN 60669-1 and EN 60669-2-1
- screw contacts 1.5mm² (max. tightening torque 0.4Nm)

(1) двупроводно свързване
two-wire connection

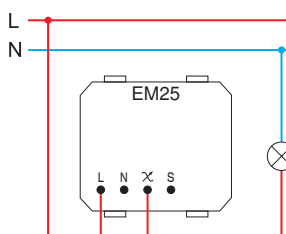

- двупроводното свързване дава възможност за димиране на лампи, позволяващи димиране
- two-wire connection allows dimming of dimmable lamps

(2) трипроводно свързване
three-wire connection

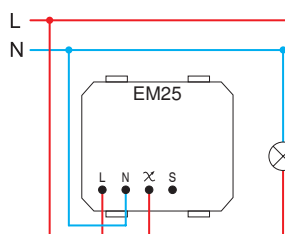

- трипроводното свързване дава възможност за димиране на лампи, позволяващи димиране, и на някои видове не позволяващи димиране светодиодни и газоразрядни лампи
- three-wire connection allows dimming of dimmable lamps and some of non-dimmable LED and CFL lamps

	1	2	5	6	7
Min.	40 W	40 W	40 VA	40 VA	40 VA
Max.	300 W	300 W	300 VA	100 VA	100 VA
	(F)	(F)	(F)		

1 – лампа с ниска напреженична /
incandescent lamp

2 – халогенна лампа /
halogen lamp

4 – Димиращ електронен трансформатор /
dimmable electronic transformer

5 – класически трансформатор /
classical transformer

	1	2	4	6	7	8	9
Min.	0 W	0 W	0 VA	0 VA	0 VA	0 VA	0 VA
Max.	300 W	300 W	120 VA	120 VA	120 VA	120 VA	120 VA
	(F)	(F)	(F)			(F)	(F)

6 – икономия на енергия при димиране на газоразрядна лампа /
dimmable energy saving CFL lamp

7 – димируема светодиодна лампа /
dimmable LED lamp

8 – без икономия на енергия при димиране на газоразрядна лампа /
non-dimmable energy saving CFL lamp

9 – недимируема светодиодна лампа /
non-dimmable LED lamp

бележки / remarks

- (F) филтър EM27
- препоръчва се използване на филтър EM27 /
it is recommended to use filter EM27
- всички управлявани лампи трябва да са от един тип /
all controlled lamps must be the same
- таблицата за товара е валидна за лампи с коефициент на мощност PF>0,5 /
table of loads is valid for lamps with power factor PF>0.5

- включване, изключване и димиране на лампа /
on / off swithcing and dimming of lamp



включване/изключване
кратковременно
натискане
on / off
short press

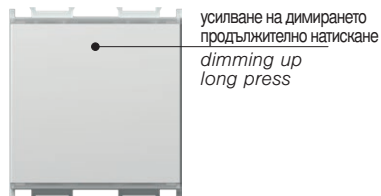

усилване на димирането
продължително натискане
dimming up
long press



намаляване на
димирането
продължително
натискане
dimming down
long press

- избиране на цвят на светодиоди и регулиране на нивото на осветеност /
LED colour selection and intensity level adjustment

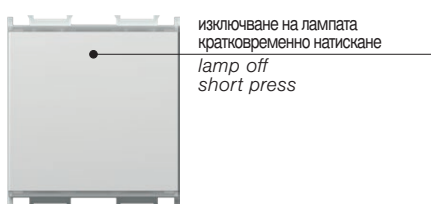

изключване на лампата
кратковременно натискане
lamp off
short press

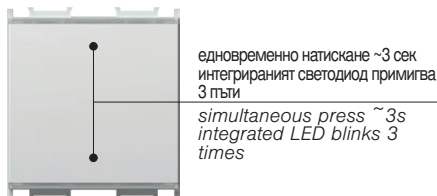

едновременно натискане ~3 сек
интегрираният светодиод примигва
3 пъти
simultaneous press ~3s
integrated LED blinks 3
times



избиране на цвят
кратковременно натискане
colour selection
short press

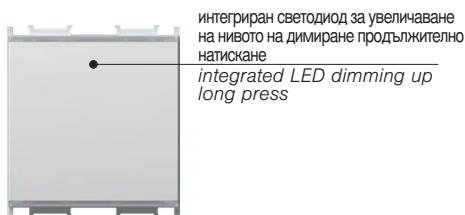

интегриран светодиод за увеличаване
на нивото на димиране продължително
натискане
integrated LED dimming up
long press

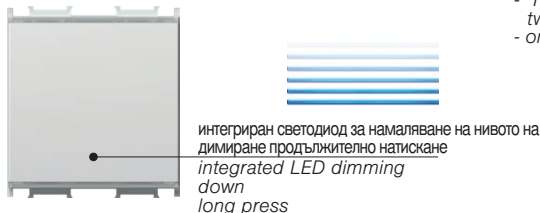

интегриран светодиод за намаляване на нивото на
димиране продължително натискане
integrated LED dimming
down
long press

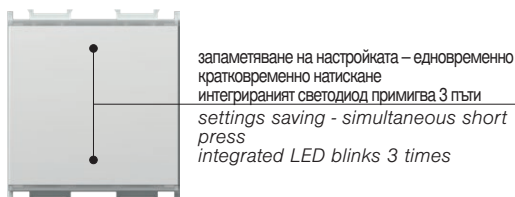

запаметяване на настройката – едновременно
кратковременно натискане
интегрираният светодиод примигва 3 пъти
settings saving - simultaneous short
press
integrated LED blinks 3 times

* функция за „нулиране“ (RESET) /
“RESET” function

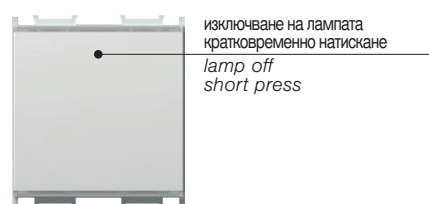

изключване на лампата
кратковременно натискане
lamp off
short press



едновременно натискане ~3 сек
интегрираният светодиод примигва
3 пъти
simultaneous press ~3s
integrated LED blinks 3
times



едновременно натискане ~5 сек
интегрираният светодиод примигва
5 пъти
re-simultaneous press ~5s
integrated LED blinks 5
times

- * - препоръчва се при инсталиране на димер и смяна на лампи
- задължително, ако се използват лампи, не позволяващи димиране
- функцията за „нулиране“ (RESET) не е налична при използване на
- двупроводно свързване
- възможно е само за EM25

- it is recommended at dimmer installation and lamp replacement
- mandatory when using non-dimmable lamps
- “RESET” function is not possible when using two-wire connection
- only possible on EM25

предупреждения във връзка с инсталирането /
installation precautions

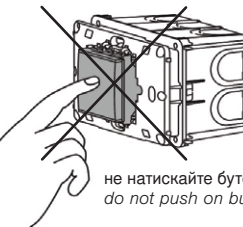
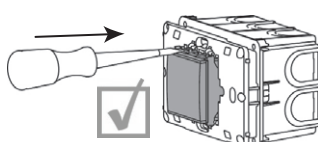
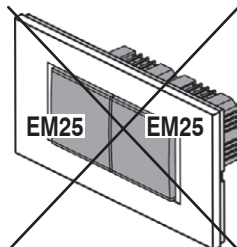
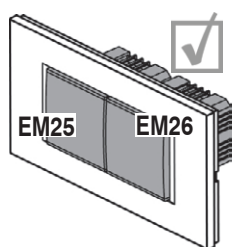

не натискайте бутона по време на монтажа
do not push on button during mounting

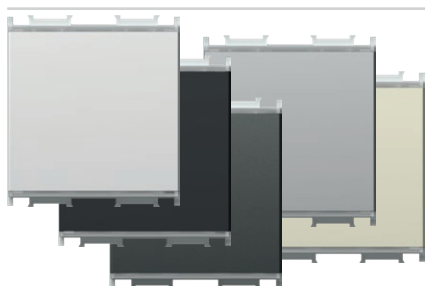

- EM26PW
- EM26SB
- EM26AT
- EM26ES
- EM26IW

БУТОННО УСТРОЙСТВО ЗА УПРАВЛЕНИЕ 2M

- свързано към универсален димер EM25 дава възможност за управление на лампи със същата функционалност (максимално до) като EM25
- захранващо напрежение 230 V~ 50 Hz
- в съответствие с EN 60669-1 и EN 60669-2-1
- винтови контакти за проводници 1,5 mm²
- (макс. въртящ момент за притягане 0,4 Nm)

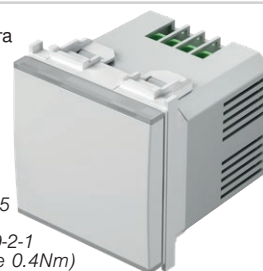

PUSH-BUTTON CONTROL UNIT 2M

- connected to universal dimmer EM25 allows controlling of lamps with same functionality as EM25
- supply voltage 230V~ 50Hz
- in accordance with EN 60669-1 and EN 60669-2-1
- screw contacts 1.5mm² (max. tightening torque 0.4Nm)

(1)двупроводно свързване
two-wire connection

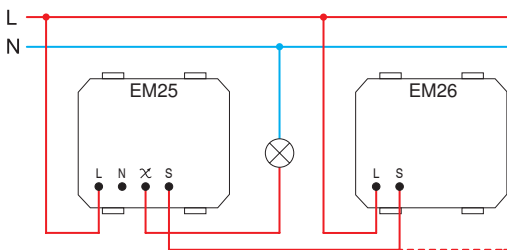

- двупроводното свързване дава възможност за димиране на лампи, позволяващи димиране
- при двупроводно свързване всяко допълнително устройство за управление увеличава минималния товар с 25 W

- two-wire connection allows dimming of dimmable lamps
- in a two-wire connection each additional control unit increases the minimum load by 25W

(2)трипроводно свързване
three-wire connection

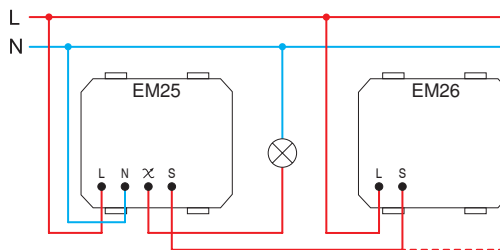

- трипроводното свързване дава възможност за димиране на лампи, позволяващи димиране, и на някои видове не позволяващи димиране светодиодни и газоразрядни лампи
- three-wire connection allows dimming of dimmable lamps and some of non-dimmable LED and CFL lamps



EM27

ЧЕСТОТЕН ФИЛТЪР

- честотен филтър за EM25
- изображението е символично

FREQUENCY FILTER

- frequency filter for EM25
- image is symbolic

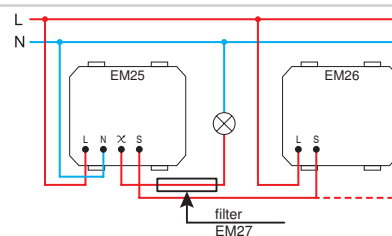

КОМПЛЕКТ КЛЮЧНИ УНИВЕРСАЛЕН ДИМЕР ЗА АКТИВНИ ИНДУКТИВЕН КАПАЦИТИВЕН ТОВАР 0-300W 2M PP OL20

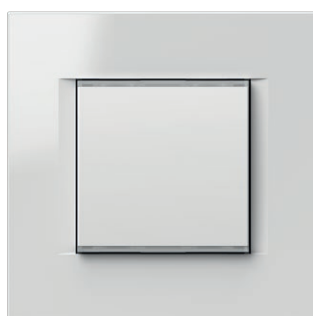

□ EM25PPOL20

- комплектът съдържа димер EM25, монтажна рамка 2M и панел LINE 2M PW
- за технически подробности вижте EM25

SET SWITCH / DIMMER UNIVERSAL RLC 0-300W 2M PP OL20

- set includes dimmer EM25, mounting frame 2M and cover plate LINE 2M PW
- for technical details see EM25



2M = 45 x 45

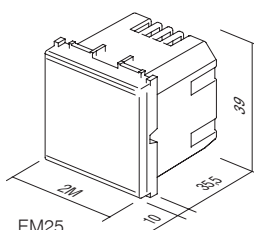

EM25
EM26

КЛЮЧ IR 5 A 230 V~ 1M



- EM31PW
- EM31SB
- EM31AT
- EM31ES
- EM31IW

- инфрачервен ключ IR
- захранващо напрежение: 230 V~ ±10 % 50 Hz
- реле: 5 A/250 V~ (нулевата стойност)
- клас на защита: IP40
- сечение на проводниците при контакта 0,75 - 2,5 mm²
- ъгъл на откриване: до 110° при 20° C
- разстояние на откриване: прил. 8 m при 20° C
- регулируема продължителност: от прил. 5 сек до 12 мин
- регулиране на яркостта на осветлението: от прил. 5 до 200 лукса
- работна температура: от 0° C до +40° C
- не е подходящо за инсталиране в конзоли с дълбочина 45 mm и конзоли за външен монтаж CUBO IP20
- само за използване на закрито



IR SWITCH 5A 230V~ 1M

- IR infrared switch
- supply voltage: 230V~ ±10 % 50Hz
- relay: 5A / 250V~ (zero crossing)
- protection rating: IP40
- cross-section of wires at the contact terminal: 0.75 - 2.5 mm²
- detection angle: up to 110° at 20°C
- detection area: approx. 8 m at 20°C
- adjustability of duration: from approx. 5 s to 12 min
- adjustability of brightness: from approx. 5 to 200 LUX
- operating temperature: from 0°C to +40°C
- not suitable for installation in 45 mm deep boxes and surface mount box CUBO IP20
- only for indoor usage

КЛЮЧ IR 5 A 230V~ 2M

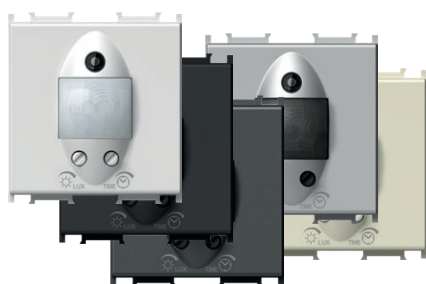

- EM32PW
- EM32SB
- EM32AT
- EM32ES
- EM32IW

- инфрачервен ключ IR
- захранващо напрежение: 230 V~ ±10 % 50 Hz
- реле: 5 A/250 V~ (нулевата стойност)
- клас на защита: IP40
- сечение на проводниците при контакта 0,75 - 2,5 mm²
- ъгъл на откриване: до 110° при 20° C
- разстояние на откриване: прил. 8 m при 20° C
- регулируема продължителност: от прил. 5 сек до 12 мин
- регулиране на яркостта на осветлението: от прил. 5 до 200 лукса
- работна температура: от 0° C до +40° C
- не е подходящо за инсталиране в конзоли с дълбочина 45 mm и конзоли за външен монтаж CUBO IP20
- само за използване на закрито



IR SWITCH 5A 230V~ 2M

- IR infrared switch
- supply voltage: 230V~ ±10 % 50Hz
- relay: 5A / 250V~ (zero crossing)
- protection rating: IP40
- cross-section of wires at the contact terminal: 0.75 - 2.5 mm²
- detection angle: up to 110° at 20°C
- detection area: approx. 8 m at 20°C
- adjustability of duration: from approx. 5 s to 12 min
- adjustability of brightness: from approx. 5 to 200 LUX
- operating temperature: from 0°C to +40°C
- not suitable for installation in 45 mm deep boxes and surface mount box CUBO IP20
- only for indoor usage

обхват на откриване /
detection range

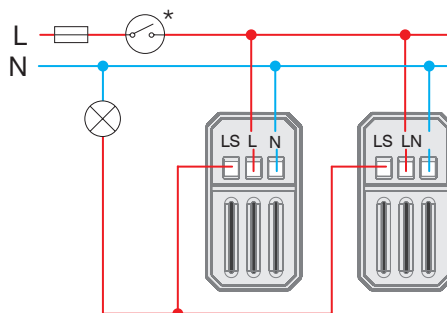
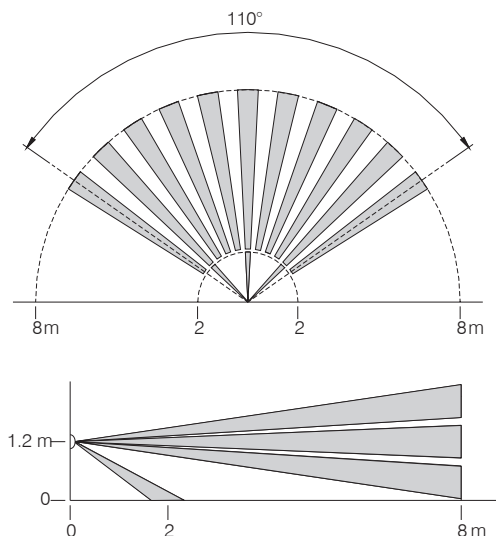

E L E C T R O N I C S E M

настройка на времето и осветеността C
time and twilight adjustment

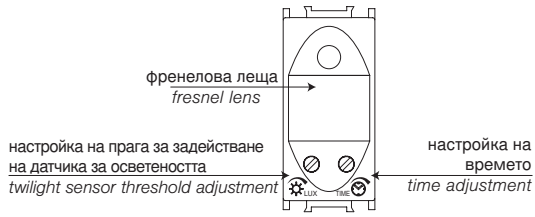

	~5 s	~12 min
	5 LUX	200 LUX

	1	2	3	4	5	6	7	8
Min.	1 W	1 W		1 VA	1 W	1 W	1 VA	1 VA
Max.	800 W	800 W	5A	6x20 VA	6x36 W	4x36 W (20μF)	6x23 VA	6x20 VA

1 – лампа с нажежаема жичка / incandescent lamp

2 – халогенна лампа / halogen lamp

3 – съпротивителен нагревателен елемент / resistive heating element

4 – електронен преобразовател / electronic transformer

5 – флуоресцентна пурa (версия 1) / fluorescent tube (version 1)

6 – флуоресцентна пурa (версия 2) / fluorescent tube (version 2)

7 – енергоспестяваща газоразрядна лампа / energy saving CFL lamp

8 – светодиодна лампа / LED lamp

внимание / attention

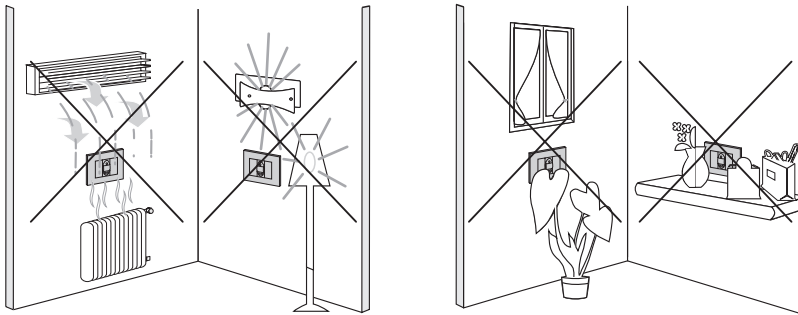

1M = 22,5 x 45

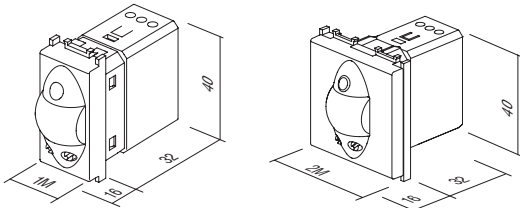

ТЕРМОСТАТ ОСНОВЕН 6A 230V~ 2M



- EM37PW
- EM37SB
- EM37AT
- EM37ES
- EM37IW

- електронен термостат, базов
- работен режим: отопление/охлаждане/изключване
- захранващо напрежение: 230 VAC, 50 Hz
- изход: 6(2) A, 230 VAC, релееен ключ
- обхват на регулиране: +10° C до +30° C
- хистерезис: ±0,5° C, ED = 20 мин
- защита против замръзване (режим на отопление): +6° C
- защита против прегряване (режим на охлаждане): +32° C
- функция ECO за намаляване на температурата с 3° C за 6 часа в режим на отопление и повишаване на температурата с 3° C за 6 часа в режим на охлаждане
- адаптивна функция ECO function, ежедневно автоматично в едно и също време намаляване на температурата с 3° C за 6 часа в режим на отопление и повишаване на температурата с 3° C за 6 часа в режим на охлаждане
- опция за включване на работния режим ECO чрез външно задействане по отделен вход
- светодиодна индикация за режима на работа
- не е подходящо за електрическо подово отопление
- винтови контакти макс. 2,5 mm²
- в съответствие с Директивата за ниско напрежение, Директивата за EMC, стандарти EN60730-1 и EN60730-2-9
- за правилно функциониране препоръчваме да се инсталира в единична отделна конзола, отделно от устройства, излъчващи топлина
- работна температура: 5 ÷ 35° C
- температура на съхраняване: -20 ÷ 50° C



Термостатът е предназначен за регулиране на температурата в помещението. Термостатът предоставя два работни режима – отопление или охлаждане. Той има инсталирани функции за безопасност – за защита против замръзване (режим на отопление) и - защита против прегряване (режим на охлаждане). Индикацията за действието му е чрез светодиоди. Настройката на термостата се осъществява с въртящ се регулатор за задаване на температурата и с други сензорни капацитивни бутони.

The thermostat is intended for regulating temperature in a room. A thermostat enables two modes of operation – heating or cooling. It has safety functions installed for protection against freezing (heating mode) and protection against overheating (cooling mode). The operation is indicated via LED lights. Thermostat setup is performed with the help of a rotary button for setting the temperature and with other capacitive touch buttons.

THERMOSTAT BASIC 6A 230 V ~ 2M

- electronic thermostat, basic
- operation mode: heating/cooling/turn off
- power supply: 230 VAC, 50 Hz
- output: 6(2) A, 230 VAC, relay switch
- regulation range: +10 °C to +30 °C
- hysteresis: ±0.5 °C, ED = 20min
- anti-freeze protection (heating mode): +6 °C
- overheating protection (cooling mode): +32 °C
- ECO function for lowering the temperature by 3 °C for 6 hours in the heating mode and raising temperature by 3 °C for 6 hours in the cooling mode
- adaptive ECO function, automatically every day at the same time lowers the temperature by 3 °C for 6 hours in the heating mode and raises temperature by 3 °C for 6 hours in the cooling mode
- option to turn on the ECO operating mode by external trigger via a separate input
- LED indication of operation
- not suitable for electrical floor heating
- screw contacts max. 2.5 mm²
- in accordance with the LV Directive, the EMC Directive, standards EN60730-1 and EN60730-2-9
- for correct operation, we recommend installing in an independent single box, separate from devices that generate heat
- operating temperature: 5 ÷ 35 °C
- storage temperature: -20 ÷ 50 °C

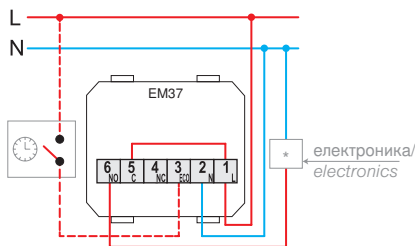

циркуляционна помпа, горелка (директно свързване), термоелектрическо задвижване/
circulation pump, burner (direct connection)
thermoelectric drive

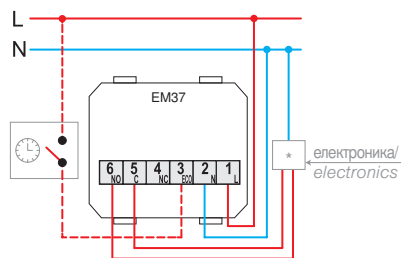

бойлер, помпа за отоплението, горелка (управляващ вход T1/T2) /
boiler, heat pump, burner (control input T1/T2)

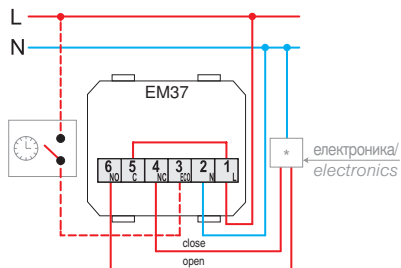

задвижване с мотор (ограничено използване с подово отопление) /
motor drive (limited use with underfloor heating)

настройка на функцията и температурата
function and temperature adjustment

бутон за избиране на функция и светодиолен индикатор за състоянието:
червен: отопление
син: климатизация
без светещ индикатор: изключено

function selection button and LED status indicator:
red: heating
blue: air conditioning
no light: switched off

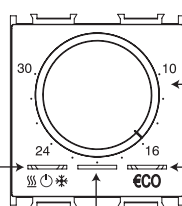

задаване на температурата
temperature setting

бутон за избиране на функция ECO и светодиолен индикатор за състоянието ECO
зелен: Включен режим на енергоспестяване ECO
оранжев: задействан адаптивен режим ECO
без светещ индикатор: дневен режим

“ECO” function selection button and LED “ECO” status indicator
green: ECO energy saving ON
orange: adaptive ECO mode activated
no light: day mode

светодиолен индикатор за състоянието на изходното релe
бял – релето е задействано
без светещ индикатор: релето е изключено

LED output relay state indicator
white: relay ON
no light: relay OFF

внимание/
attention

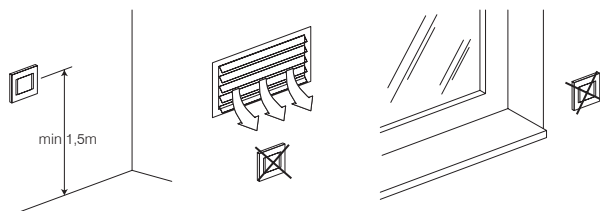

ТЕРМОСТАТ ЗА ОТОПЛЕНИЕ 5(2) A 230 V~ 2M

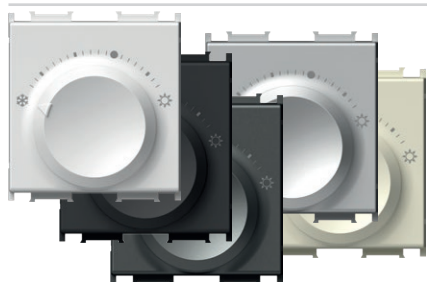

- EM38PW
- EM38SB
- EM38AT
- EM38ES
- EM38IW

- режим на работа: отопление
- захранване: 230 VAC, 50 Hz
- импулс на напрежение: 4 kV
- консумация на енергия: < 0,5 W
- изход: 2 A (макс. 5 A); 230 VAC, 50 Hz
- изходен порт: NO (макс. 10 актуатора)
- зона на регулация: +5° C до +30° C
- защита против замръзване: +5° C
- хистерезис: 0,5 K
- защита: IP30
- вид на сензора: Bimetal
- вид на електрическия изход: пружинни клеми
- вид на проводниците:
- 0,75 – 1,5 кв. мм (с гъвкава жица);
- 1,0 – 2,5 кв. мм (с твърда жица)
- в съответствие с Директива DIN EN 60730



HEATING THERMOSTAT 5(2)A 230V~ 2M

- operation mode: heating
- power supply: 230 VAC, 50 Hz
- voltage pulse: 4 kV
- energy consumption: < 0.5 W
- output: 2 A (max. 5 A); 230 VAC, 50 Hz
- switching output: NO (max. 10 actuators)
- regulation range: +5°C to +30°C
- frost protection: +5°C
- hysteresis: 0.5 K
- protection: IP30
- sensor type: Bimetal
- type of electrical connection: Spring-loaded contacts
- type of conductors: 0.75 – 1.5 mm² (flexible-stranded core);
- 1.0 – 2.5 mm² (solid core)
- in compliance with Directive DIN EN 60730

ТЕРМОСТАТ ЗА ОТОПЛЕНИЕ/ОХЛАЖДАНЕ 3(1,5) A 230 V~ 2M

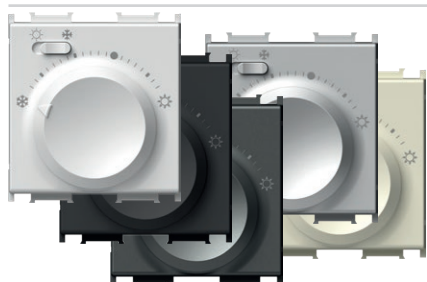

- EM39PW
- EM39SB
- EM39AT
- EM39ES
- EM39IW

- режим на работа: отопление/охлаждане
- захранване: 230 VAC, 50 Hz
- импулс на напрежение: 4 kV
- консумация на енергия: < 0,5 W
- изход: 1.5 A (макс. 3 A); 230 VAC, 50 Hz
- изходен порт:
- ключ за превключване (макс. 5 актуатора)
- зона на регулация: +5° C до +30° C
- защита против замръзване: +5° C
- хистерезис: 0,5 K
- защита: IP30
- вид на сензора: Bimetal
- вид на електрическия изход: пружинни клеми
- вид на проводниците:
- 0,75 – 1,5 кв. мм (с гъвкава жица);
- 1,0 – 2,5 кв. мм (с твърда жица)
- в съответствие с Директива DIN EN 60730



HEATING/COOLING THERMOSTAT 3(1.5)A 230V~ 2M

- operation mode: cooling/heating
- power supply: 230 VAC, 50 Hz
- voltage pulse: 4 kV
- energy consumption: < 0.5 W
- output: 1 A (max. 3 A); 230 VAC, 50 Hz
- switching output: mode selector switch (max. 5 actuators)
- regulation range: +5°C to +30°C
- frost protection: +5°C
- hysteresis: 0.5 K
- protection: IP30
- sensor type: Bimetal
- type of electrical connection: Spring-loaded contacts
- type of conductors: 0.75 - 1.5mm² (flexible-stranded core);
- 1.0 - 2.5 mm² (solid core)
- in compliance with the Directive DIN EN 60730

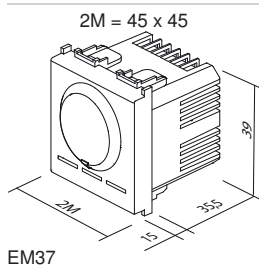

EM37

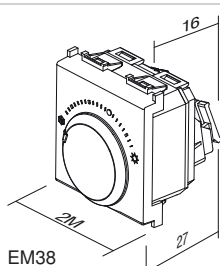

EM38

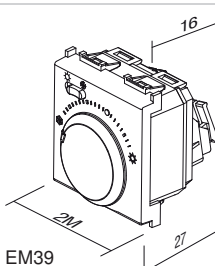

EM39

МОНТАЖНА РАМКА С ВИНТОВЕ ЗА ТЕРМОСТАТИ FANTINI COSMI 3M

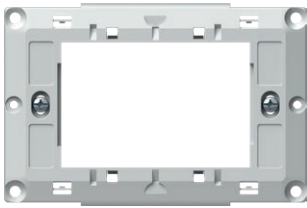

NM39

- монтажна рамка с винтове за термостати Fantini Cosmi 3M
- подходяща за използване с моделите еднокдневни термостати Fantini Cosmi CH121 и CH123
- подходяща за използване с моделите едноседмични термостати Fantini Cosmi CH141A и CH143A
- за монтаж в правоъгълни конзоли 3M
- подходящо за сглобяване с панели PURE, Line, Soft

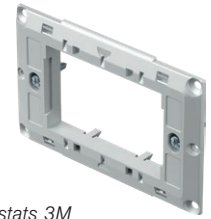

MOUNTING FRAME WITH SCREWS FOR FANTINI COSMI THERMOSTATS 3M

- mounting frame with screws for Fantini Cosmi thermostats 3M
- suitable for use with Fantini Cosmi daily thermostats models CH121 and CH123
- suitable for use with Fantini Cosmi weekly thermostats models CH141A and CH143A
- for mounting in rectangular boxes 3M
- suitable for assembling with cover plates PURE, Line, Soft

КЛЮЧ С КАРТА ЗА ИКОНОМИЯ НА ЕНЕРГИЯ ЗА 250V ~ 3M



- EM40PW
- EM40SB
- EM40AT
- EM40ES
- EM40IW

- ключ с карта, базов, всякаква ISO карта
- захранващо напрежение 230 V~ 50 Hz
- изход 3 A 250 V~ за комутационния контактор *
- закъснение при изключване 15-20 сек
- в съответствие с EN 61000-6-1
- картата не е включена в доставката
- не е предназначено за контрол на достъпа



ENERGY SAVER CARD SWITCH 3A 250V~ 3M

- card switch basic, any ISO card
- supply voltage 230V~ 50Hz
- output 3A 250V~ for switching contactor *
- switch off delay 15-20s
- in accordance with EN 61000-6-1
- card is not included
- not for access control

3M = 67,5 x 45

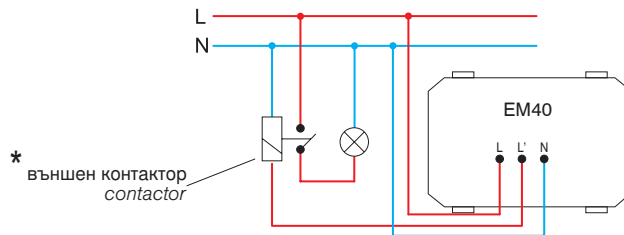
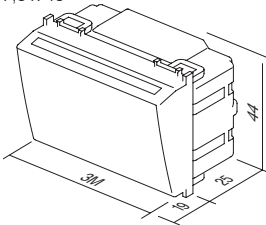

КАРТА ISO



EM47

- карта ISO
- за комбинация с ключ с карта EM40
- размер: 85x54 mm

CARD ISO

- ISO card
- for combination with card switch EM40
- size: 85x54 mm



EM44BK

КЛЮЧ С КАРТА ЗА ИКОНОМИЯ НА ЕНЕРГИЯ RF HF 13,56 MHz 3M

- електронен ключ с карта за RFID ISO карта
- захранва се от релейно устройство EM49 по кабел конектори тип RJ12
- изходът трябва да се свързва с изхода на релейно устройство EM49
- закъснение при изключване на „главното захранване“ 15-20 сек. при изваждане на картата
- закъснение 1 мин. при изключване на „HVAC“ (Отопление, вентилация и климатизация) при изваждане на картата, когато се отворят врати на балкон или прозорец
- в съответствие с EN 61000-6-1
- картата не е включена в доставката
- не е предназначено за контрол на достъпа

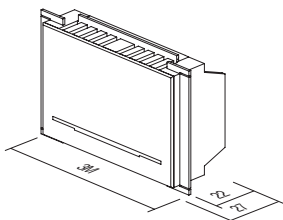

ENERGY SAVER CARD SWITCH RF HF 13,56MHz 3M

- electronic card switch for RFID ISO card
- supply from relay unit EM49 through cable connectors RJ12
- output to be connected to relay output unit EM49
- 15-20s "main power" switch off delay with card withdrawal
- 1 min "HVAC" switch off delay with card withdrawal when balcony doors or windows opened
- in accordance with EN 61000-6-1
- card is not included
- not for access control

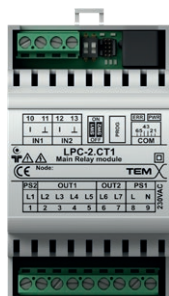

EM49

УСТРОЙСТВО ЗА УПРАВЛЕНИЕ ЗА ИКОНОМИЯ НА ЕНЕРГИЯ 2x16 A 250 V ~

- релейно устройство за ключове с карта EM44
- захранващо напрежение 230 V ~ 50 Hz
- в съответствие с EN 61000-6-1
- за монтаж върху DIN релса 35 mm, 3 MU
- входът и изходът зависят от реализацията: единична или двойна стая

ENERGY SAVER CONTROL UNIT 2x16A 250V~

- relay unit for card switches EM44
- supply voltage 230V ~ 50Hz
- in accordance with EN 61000-6-1
- mounting on DIN rail 35mm, 3MU
- input and output depending on implementation: single or double room

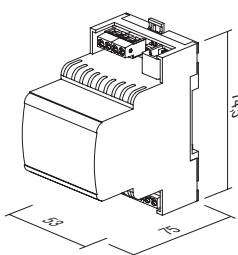

EM45

РАЗПРЕДЕЛИТЕЛ SPL-1

- служи за свързване на два периферни модула EM44 към релейно устройство EM49
- комуникационен конектор тип RJ12
- размер: 37 x 30 x 27 mm

SPLITTER SPL-1

- used to connect two peripheral modules EM44 to relay unit EM49
- communication connector RJ12
- size: 37 x 30 x 27 mm

схема на свързване при реализация за единична стая / wiring diagram for single room implementation

схема на свързване при реализация за двойна стая / wiring diagram for double room implementation

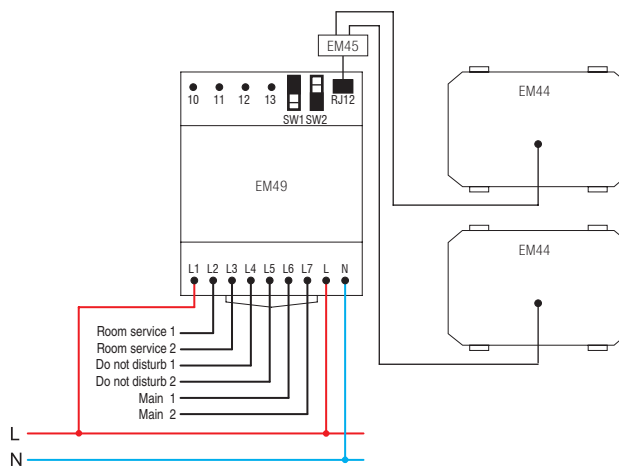
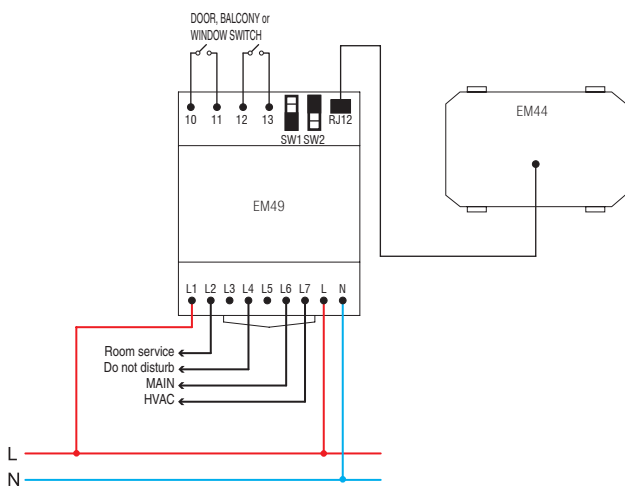

съединителен кабел RJ12 между EM44 и EM49 / connection cable RJ12 between EM44 and EM49

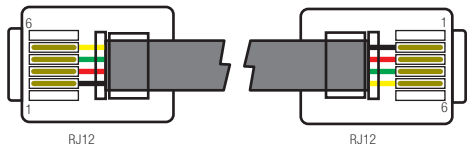

КОНТАКТ ЗА САМОБРЪСНАЧКА 230 V~/120 V~ 3M

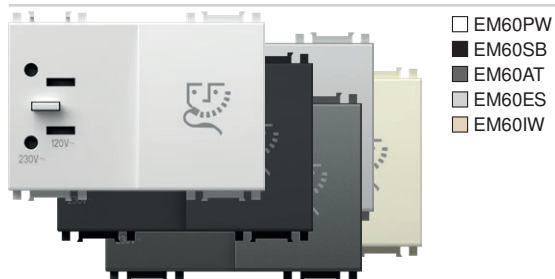

- EM60PW
- EM60SB
- EM60AT
- EM60ES
- EM60IW

- захранващо устройство с разделителен трансформатор 20 VA
- захранване: 230 V~ 50-60 Hz
- изход:
230 V~ за 2P 2,5 A Europlug или
120 V~ за 2P 15 A Американски щепсел
- клас II
- в съответствие с EN 61558-2-5

SOCKET SHAVER 230V~/120V~ 3M

- shaver supply unit with isolating transformer 20VA
- supply: 230V~ 50-60Hz
- output:
230V~ for 2P 2.5A Europlug or
120V~ for 2P 15A American plug
- Class II
- in accordance with EN 61558-2-5

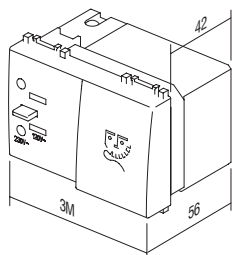

3M = 67,5 x 45

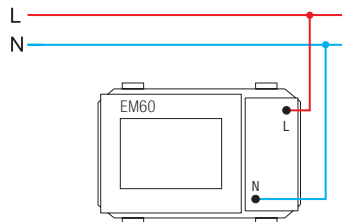

USB ЗАХРАНВАЩО УСТРОЙСТВО 5 V 2,1 A 1M



- EM67PW
- EM67SB
- EM67AT
- EM67ES
- EM67IW

- за зареждане на електронни устройства от стандартен USB порт (съвместим и с устройства от Apple)
- захранване: 100-230 V~ 50/60 Hz
- консумация: 300 mA при 100 V~/150 mA при 230 V~
- консумация в режим на готовност: 30mW при 230 V~
- номинално изходно напрежение: 5 VDC (±5%) SELV (безопасно ниско напрежение)
- напрежение на пулсациите на изхода: 150 mV
- номинален изходен ток: 2.1 A (1 x 2,100 mA) (±10%)
- КПД: максимално 77%
- работна температура: 0° C/+45° C (само за използване на закрито)
- клас на IP защита: IP20, само за използване на закрито
- устройство клас II
- категория за превишаване на напрежение (EN 62109): клас III
- винтови контакти: макс. 2,5 mm²
- устройство с разстояние между контактите най-малко 3 mm
- в съответствие с EN 60950-1 и директивите за устройства за ниско напрежение и EMC

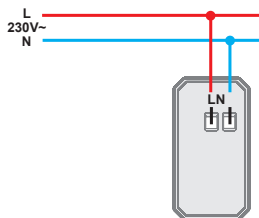
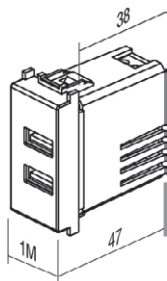

USB POWER SUPPLY UNIT 5V 2.4A 1M

- for charging of electronic devices via a standard USB port (also compatible with Apple devices)
- power supply: 100-230V~ 50/60Hz
- power consumption: 300mA at 100V~/150mA at 230V~
- standby power consumption: 30mW at 230V~
- nominal output voltage: 5 VDC (± 5%) SELV
- output ripple voltage: 150mV
- nominal output current: 2,4A (±10%)
- efficiency: maximum of 77%
- operating temperature: 0° C/+45° C (indoor use)
- IP protection class: IP20, indoor use only
- class device II
- overvoltage category (EN 62109): Class III
- screw contacts: max. 2.5 mm²
- device with a contact gap of at least 3mm
- in accordance with EN 60950-1 and LVD & EMC directives

USB ЗАХРАНВАЩ БЛОК 5V 3,0A



- EM68PW
- EM68SB
- EM68AT
- EM68ES
- EM68IW

- за зареждане на електронни устройства чрез стандартен USB порт (съвместим с устройства на Apple)
- захранване: 100-230V~ 50/60Hz
- консумация на енергия: 300mA при 100V~/150mA при 230V~
- консумация на енергия в режим на готовност: 30mW при 230V~
- номинално изходно напрежение: 5 VCD (± 5%) SELV
- изходно напрежение на пулсации: 150 mV
- номинален изходен ток: 3,0 A (±10%)
- вид конектор: USB A/USB C
- ефективност: максимум 77%
- температура на работа: 0°C/+45°C (за употреба в затворени пространства)
- Клас на IP защита: IP20, само за употреба в затворени пространства
- устройство клас II
- категория свръхнапрежение (EN 62109): Клас III
- контакти с винтови клеми: макс. 2,5 mm²
- устройство с контактна междина най-малко 3 mm
- в съответствие с Директива EN 60950-1 и Директива за безопасност на нисковолтови електрически съоръжения (LVD) и Директива относно електромагнитна съвместимост (EMC)

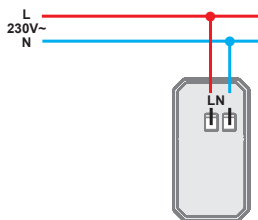
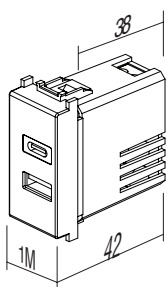

USB POWER SUPPLY UNIT 5V 3,0A

- for charging of electronic devices via a standard USB port (also compatible with Apple devices)
- power supply: 100-230V~ 50/60Hz
- power consumption: 300mA at 100V~/150mA at 230V~
- standby power consumption: 30mW at 230V~
- nominal output voltage: 5 VCD (± 5%) SELV
- output ripple voltage: 150mV
- nominal output current: 3,0 A (±10%)
- connector type: USB A / USB C
- efficiency: maximum of 77%
- operating temperature: 0°C/+45°C (indoor use)
- IP protection class: IP20, indoor use only
- class device II
- overvoltage category (EN 62109): Class III
- screw contacts: max. 2.5 mm²
- device with a contact gap of at least 3mm
- in accordance with EN 60950-1 and LVD & EMC directives

СВЕТОДИОДНО АВАРИЙНО ОСВЕТЛЕНИЕ 250 V~ 0,90 W, NiCd 3h 7M



- EM55

- светодиодна лампа за аварийно осветление
- захранващо напрежение 250 V~ 50 Hz 3 x LED 0,3 W, 10000 mcd, 6500 K
- NiCd акумулатор 400 mAh, позволяващ смяна автономно действие 3 часа, зареждане 24 часа
- клас II
- в съответствие с EN 60598-1, EN 60598-2-2, EN 60598-2-22



LED EMERGENCY LIGHT 250V~ 0.90W, NiCd 3h 7M

- emergency LED lamp
- supply voltage 250V~ 50Hz 3x LED 0,3W, 10000mcd, 6500K
- NiCd accumulator 400 mAh, replaceable
- autonomy 3h, charging 24h
- Class II
- in accordance with EN 60598-1, EN 60598-2-2, EN 60598-2-22

7M = 151,5 x 45

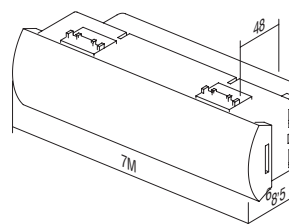
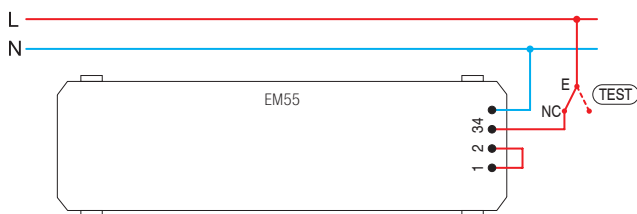

АВАРИЙНА СВЕТОДИОДНА ЛАМПА 230V~50 Hz, 0,5 W, NiMH 2h 2M



- EM57

- аварийна светодиодна лампа
- с опция за употреба и като ръчна лампа (издърпващ се механизъм)
- захранващо напрежение 230 V~50 Hz, 1xLED 0,5 W
- Акумулаторна NiMH батерия 140 mAh, сменяема
- автономна работа 2 часа, зареждане 36 часа
- устройство клас II
- в съответствие с EN60598-1, EN60598-2-2, EN62471, EN55015:2006, EN61547

LED EMERGENCY LIGHT 230V~50Hz, 0.5W, NiMH 2h 2M

- emergency LED lamp
- option to use it as a hand lamp (pull-out mechanism)
- supply voltage 230V~ 50Hz, 1xLED 0.5W
- NiMH accumulator 140mAh, replaceable
- autonomy 2h, charging 36h
- class device II
- in accordance EN60598-1, EN60598-2-2, EN62471, EN55015:2006, EN61547

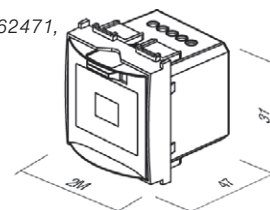
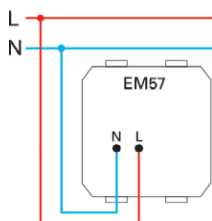
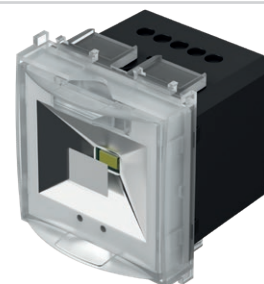

ЕДНОЦВЕТНА СВЕТОДИОДНА ЛАМПА 250 V~ 0,8 W 2M

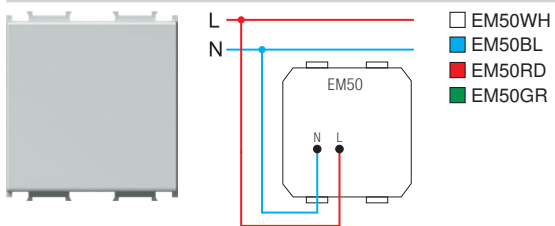

- светодиодна лампа за обозначаване на стъпала
- захранващо напрежение 230 V~ 50 Hz 0,8 W, 6500 K
- клас II
- в съответствие с EN 60598-1
- възможно е да се използва за осветяване на знаци за сигнализация и упътване с отпечатване на текст по желание на клиента с лазерен печат върху дифузъора

LED LAMP MONOCOLOR 250V~ 0,8W 2M

- step marker LED lamp
- supply voltage 230V~ 50Hz 0,8W, 6500K
- Class II
- in accordance with EN 60598-1
- optional usage for directional or signal illumination with customized laser printing on diffuser



ДВУЦВЕТНА СВЕТОДИОДНА ЛАМПА 250 V~ 2 x 0,4 W 2M

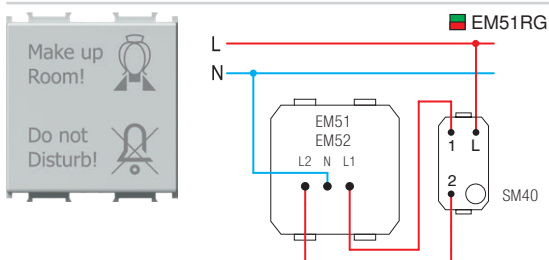

- светодиодна лампа с двоен сигнален цвят (червен/зелен)
- захранващо напрежение 230 V~ 50 Hz 2 x 0,4 W, 6500 K
- клас II
- в съответствие с EN 60598-1
- върху дифузъора има графично изображение, както е показано
- възможно е отпечатване по желание на клиента с лазерен печат върху дифузъора

LED LAMP DUAL COLOR 250V~ 2x0,4W 2M

- signaling dual color (red/green) LED lamp
- supply voltage 230V~ 50Hz 2x0,4W, 6500K
- Class II
- in accordance with EN 60598-1
- diffuser includes graphics as shown
- possible customized laser printing on diffuser



ДВУЦВЕТНА СВЕТОДИОДНА 3D ЛАМПА 250 V~ 2 x 0,4 W 2M

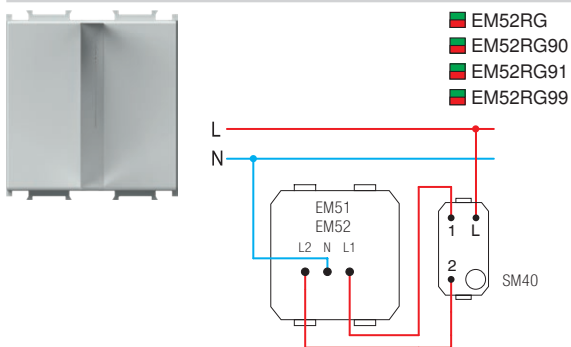

- сигнална светодиодна лампа, два цвята (червен/зелен) с 3D символ
- захранващо напрежение 230 V~ 50 Hz 2 x 0,4 W, 6500 K
- клас II
- в съответствие с EN 60598-1
- възможно е отпечатване на графично изображения по желание на клиента
- 90 символ „Мъже“, 91 символ „Жени“, 99 символ по поръчка

LED LAMP 3D DUAL COLOR 250V~ 2x0,4W 2M

- signalling LED lamp, dual color (red/green) with 3D symbol
- supply voltage 230V~ 50Hz 2x0,4W, 6500K
- class II
- in accordance with EN 60598-1
- possible customized graphics on request
- 90 male symbol, 91 female symbol, 99 symbol on request

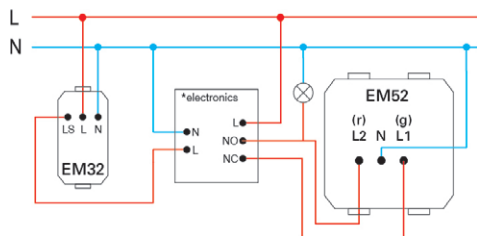
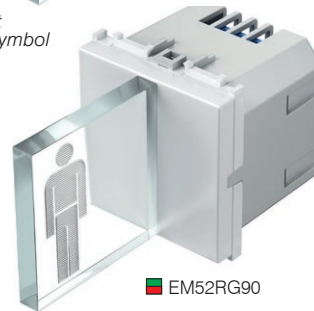
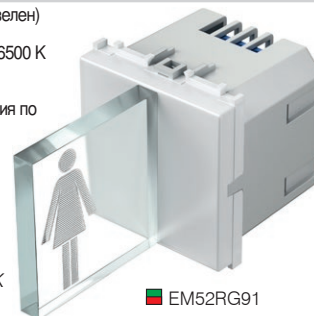

2M = 45 x 45

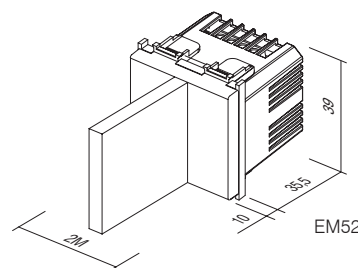
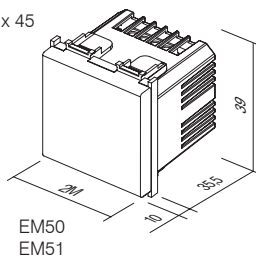

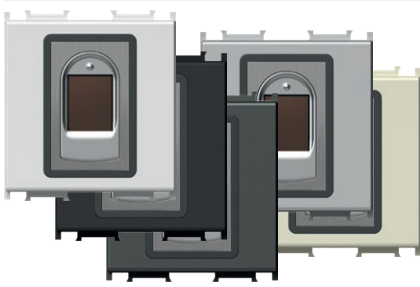

- EM71PW
- EM71SB
- EM71AT
- EM71ES
- EM71IW

ПРЕВКЛЮЧВАТЕЛ С ПРЪСТОВ ОТПЕЧАТЪК BIOPASS 2M

- Превключвател с пръстов отпечатък с включен вътрешен релейен модул и захранване
- Капацитет: 500 пръстови отпечатъка
- Лесно управление чрез мобилното приложение X-Manager
- Захранващо напрежение: 8 – 30 V – DC или AC (с включено захранване)
- Капацитивен сензор
- 2 изходни релета
- Максимално напрежение/ток в релето: 40 V/3 A
- Време за задействане на релето: 1 – 10 сек
- Максимална мощност: 3,6 W
- 256-битова шифрована връзка между превключвателя и вътрешния релейен модул
- Комплект с включени NM24 монтажна рамка и OS20 декоративна рамка.

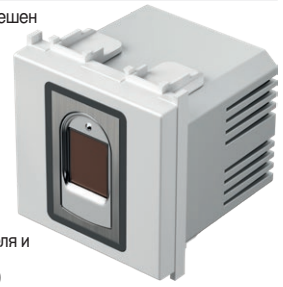

FINGERPRINT SWITCH BIOPASS 2M

- fingerprint switch with included internal relay unit and power supply
- capacity: 500 fingerprints
- easy management via X-Manager mobile app
- power supply voltage: 8-30V – DC or AC (power supply included)
- capacitive sensor
- 2 output relays
- maximum voltage/current on relay: 40V/3A
- relay triggering time: 1-10 sec
- maximum power: 3.6W
- 256-bit encrypted link between switch and internal relay unit
- Set also includes NM24 mounting frame and OS20 decorative cover plate.

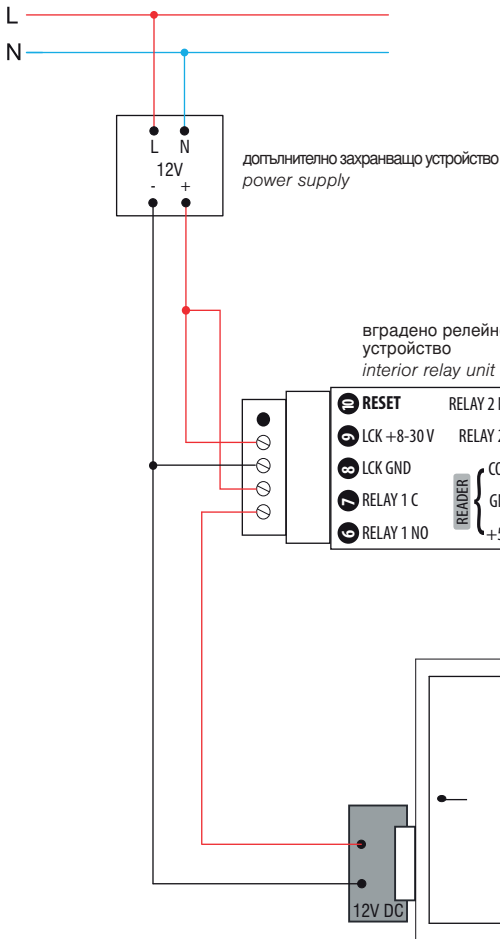

X-Manager app

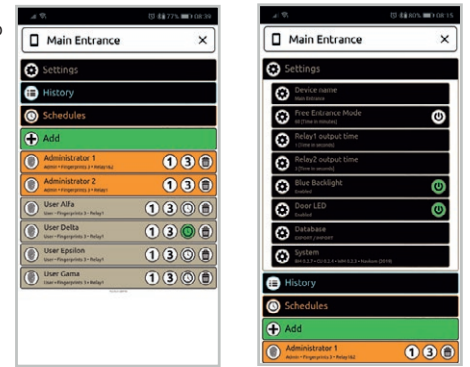

support.tem.si



**външно устройство
exterior unit**

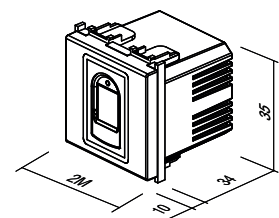

БЕЗКОНТАКТЕН КЛЮЧ, 10 А 240 V~



■ EM80GW

- безконтактен ключ за включване/изключване („главен“)
- захранване: 240 V~ 50 Hz
- релеен изход 10 A/250 V~ (2400 W при 240 V~)
- регулируем диапазон 2 до 10 cm
- предназначен е за инсталиране в стандартна кръгла конзола Ø60 mm
- за свързването се изисква проводник за неутралата (N)
- не е възможно свързване с дуплосочен ключ
- възможно е свързване с до 5 ключа за управление EM81
- лесно инсталиране на декоративни капаци с помощта на магнити
- винтово захващане на проводници със сечение до 2,5 mm² (макс. въртящ момент за притягане 0,4 Nm)
- в съответствие с EN 60669-1 и EN 60669-2-1
- само за използване на закрито



SWITCH, TOUCHLESS 10A 240V~

- touchless switch for turning on/off ("master")
- power supply: 240 V~ 50 Hz
- output relay 10A / 250V~ (2400W at 240V~)
- adjustable range from 2 to 10 cm
- intended for installation into a standard round Ø60 mm box
- a neutral lead (N) is required for connection
- connection with toggle switches is not possible
- connection with up to 5 EM81 control switches is possible
- simple installation of decorative covers with the help of magnets
- screw fastening of leads up to 2,5 mm² (max. screw tightening torque is 0.4 Nm)
- in accordance with EN 60669-1 and EN 60669-2-1
- only for indoor use

БЕЗКОНТАКТЕН КЛЮЧ, УСТРОЙСТВО ЗА УПРАВЛЕНИЕ



■ EM81GW

- ключ за управление („подчинен“)
- функционира само при свързване с ключ EM80 („главен“)
- регулируем диапазон 2 до 10 cm
- лесно инсталиране на декоративни капаци с помощта на магнити
- винтово захващане на проводници със сечение до 2,5 mm² (макс. въртящ момент за притягане е 0,4 Nm)
- в съответствие с EN 60669-1 и EN 60669-2-1
- само за използване на закрито



SWITCH, TOUCHLESS, CONTROL UNIT

- control switch ("slave")
- works only when connected with the EM80 switch ("master")
- adjustable range from 2 to 10 cm
- simple installation of decorative covers with the help of magnets
- screw fastening of leads up to 2.5 mm² (max. screw tightening torque is 0.4 Nm)
- in accordance with EN 60669-1 and EN 60669-2-1
- only for indoor use

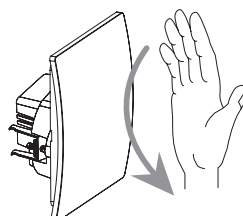
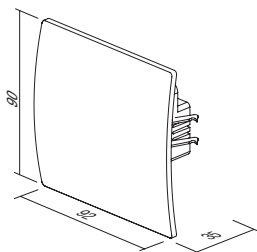
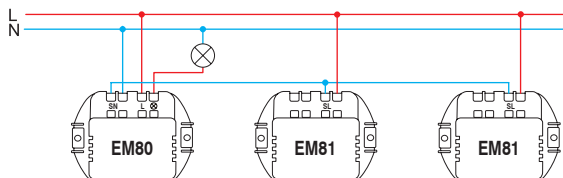
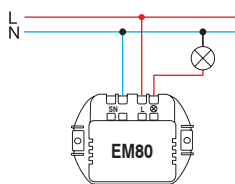

ЗУМЕР 8 VA 230 V~1M

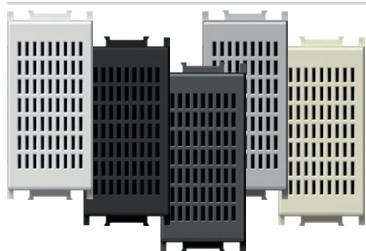

- EM91PW
- EM91SB
- EM91AT
- EM91ES
- EM91IW

- сигнален зумер
- издаването на звук продължава колкото управляващото действие
- захранващо напрежение 230 V ~ 50 Hz 8 VA

BUZZER 8VA 12V~1M

- signal buzzer
- the sound emission has the same lasting time as the control operation
- supply voltage 12V~ 50Hz 8VA

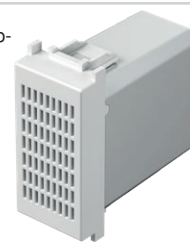

ЗВЪНЕЦ 8 VA 12V~1M

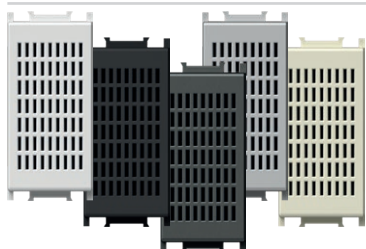

- EM93PW
- EM93SB
- EM93AT
- EM93ES
- EM93IW

- сигнален звънец
- издаването на звук продължава колкото управляващото действие
- захранващо напрежение 12 V~ 50 Hz 8 VA

BELL 8VA 12V~1M

- signal bell
- the sound emission has the same lasting time as the control operation
- supply voltage 12V~ 50Hz 8VA



CSENGŐ 230V~ 6mA rms 1M

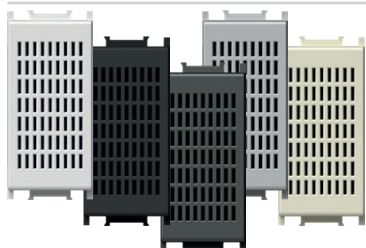

- EM94PW
- EM94SB
- EM94AT
- EM94ES
- EM94IW

- захранване: 230 В~ 50/60 Хц
- консумация за мелодия 1: 4, 7 mA rms
- консумация за мелодия 2: 5, 9 mA rms
- ниво на звука на мелодия 1: 2, 86 Дб
- ниво на звука на мелодия 2: 86 Дб
- температура при функциониране: 0 С/45 С (при вътрешно използване)
- температура при съхранение: -20 С/ 50 С
- IP защитен клас: IP20 (само за вътрешно използване)
- клас на безопасност на устройството: II
- защита от прекалено напрежение (EN62109): клас III
- прикрепване на водещите елементи с болтове: макс 2, 5 кв. мм
- устройство с оттегляне на контактите: мин 3 мм
- Леснодостъпен прекъсващ ключ може да бъде монтиран нагоре по веригата на звънеца
- В съответствие с Директивата за безопасност на нисковолтови електрически съоръжения (LVD) и Директивата относно електромагнитната съвместимост (EMC)

BELL 230V~ 6mA rms 1M

- power supply 230 V~ 50/60 Hz
- power consumption when playing melody 1: 4.7 mA rms
- power consumption when playing melody 2: 5.9 mA rms
- sound level of melody 1: 90.5 dB
- sound level of melody 2: 86 dB
- operating temperature 0°C/45°C (indoor use)
- storage temperature: -20°C /50°C
- IP protection class: IP20 (indoor use only)
- class device II
- overvoltage category (EN62109): Class III
- screw contacts: max. 2.5 mm²
- device with a contact gap of at least 3 mm
- an easily accessible cut-off switch must be installed upstream from bell
- complies with EMC & LVD directives



EM91
EM93
EM94

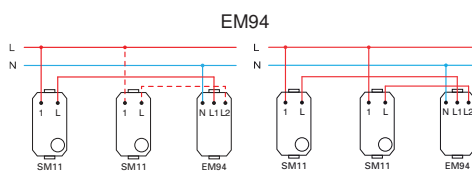
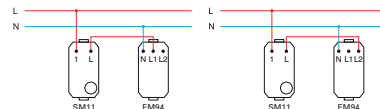
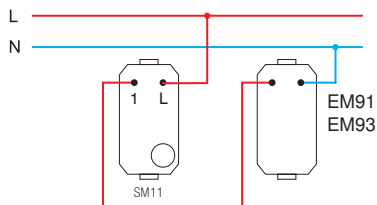
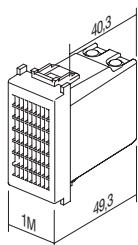

РЕГУЛАТОР НА СИЛАТА НА ЗВУКА 100 V AUDIO LINE 35 W 2M

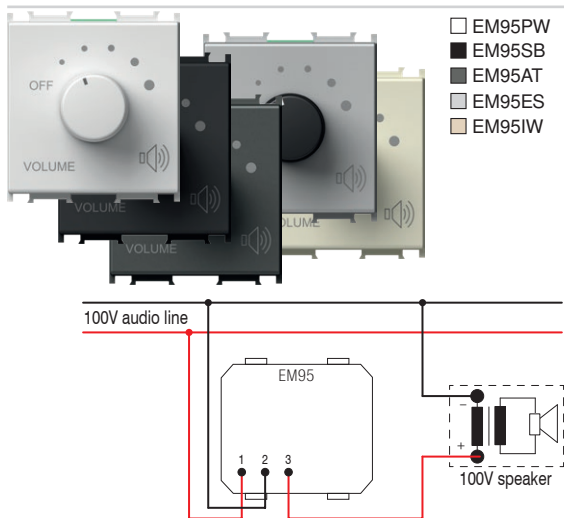

- регулатор на силата на звука (атенюатор) за аудиосистеми 100 V
- номинална мощност 35 W (макс. 45 W), 6 нива регулиране на силата на звука
- подходящо за инсталиране в конзоли (с мин. дълбочина 60 mm)
- не е подходящо за инсталиране в конзоли с дълбочина 45 mm и конзоли за външен монтаж CUBO IP20
- само за използване на закрито

VOLUME CONTROL 100V AUDIO LINE 35W 2M

- volume control (attenuator) for 100V audio systems
- power rating 35W (max.45W), 6 steps volume control
- suitable for boxes min. 60 mm deep
- not suitable for installation in 45 mm deep boxes and surface mount boxes CUBO IP20
- for indoor use only



РЕГУЛАТОР НА СИЛАТА НА ЗВУКА 4-8 Ω 35 W 2M

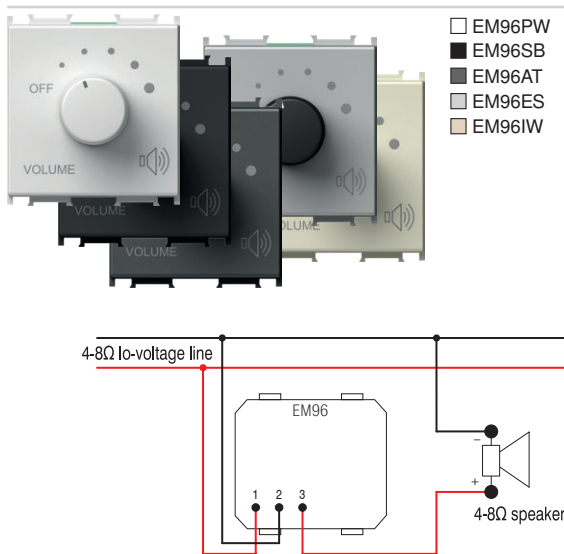

- регулатор на силата на звука (атенюатор) за изходи с ниско напрежение 4-8 Ω, 35 W
- допуска се свързване на HI-FI устройства
- номинална мощност 35 W, 6 нива на регулиране на силата на звука
- подходящо за инсталиране в конзоли (с мин. дълбочина 60 mm)
- не е подходящо за инсталиране в конзоли с дълбочина 45 mm и конзоли за външен монтаж CUBO IP20
- само за използване на закрито

VOLUME CONTROL 4-8 Ω 35W 2M

- volume control (attenuator) for low voltage outputs 4-8 Ω, 35W
- power rating 35W, 6 steps volume control
- suitable for boxes min. 60 mm deep
- not suitable for installation in 45 mm deep boxes and surface mount boxes CUBO IP20
- for indoor use only

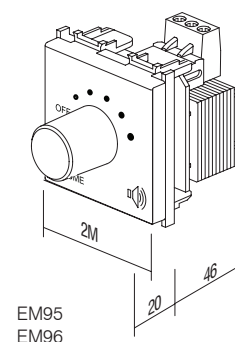

EM95
EM96

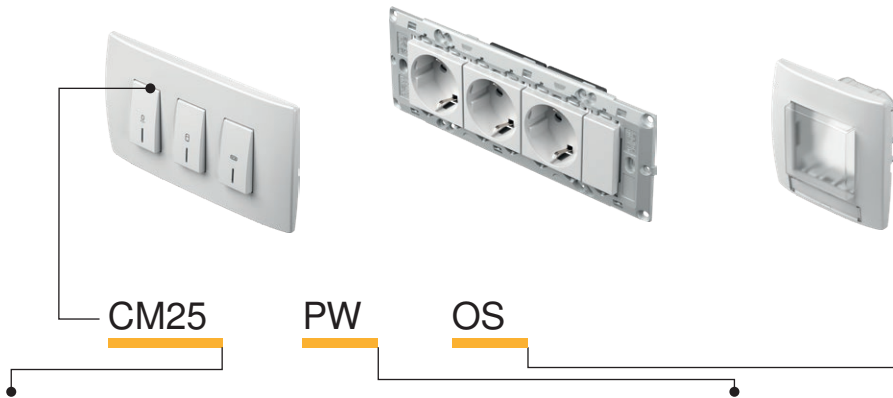

тип type	описание description	технически данни technical data	размер size	цвет colour	допълнителна информация 1 optional data 1
CM10	КОМПЛЕКТ КОНТАКТИ 2xШУКО SOCKET SET 2x SCHUKO	2P+E 16A 250V~	4M	<input type="checkbox"/> PW снежнобял цвят polar white	<input type="checkbox"/> OL панел LINE cover plate LINE
CM11	КОМПЛЕКТ КОНТАКТИ 3xШУКО SOCKET SET 3x SCHUKO	2P+E 16A 250V~	7M	<input checked="" type="checkbox"/> SB сензорен бутон, черен soft touch black	<input type="checkbox"/> OS панел SOFT cover plate SOFT
CM15	КОМПЛЕКТ СЪЕДИНИТЕЛНИ ПРОВОДНИЦИ LINK WIRE SET	3x1.5mm ²	1M	<input checked="" type="checkbox"/> AT антрацит anthracite	
·	·	·	·	<input type="checkbox"/> ES сребрист elox silver	
·	·	·	·	<input type="checkbox"/> IW слонова кост ivory white	

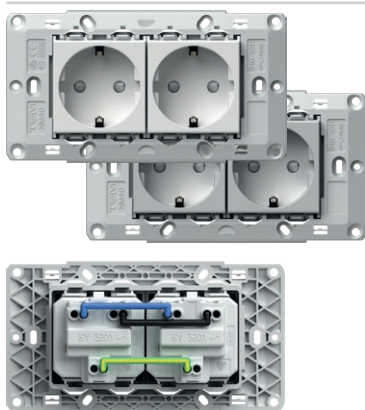

- CM10PW
- CM10ES

КОМПЛЕКТ КОНТАКТИ 2 x ШУКО 2P+E 16 A 250 V~ 4M

- комплект контакти 2 x шуко VM10 2P+E 16 A 250 V~
- предварително свързани съединителни проводници CM16
- с монтажна рамка 4M без винтове
- за закрепване към монтажна рамка използвайте винтове CM17, CM18 или CM19
- винтови контакти 1,5 - 2,5 mm²
- в съответствие с IEC 60884-1, CEE7

SOCKETS SET 2x SCHUKO 2P+E 16A 250V~ 4M

- socket set 2x schuko VM10 2P+E 16A 250V~
- prewired with link wires CM16
- with mounting frame 4M without screws
- for mounting frame fixing use screws CM17, CM18 or CM19
- screw contacts 1.5-2.5 mm²
- in accordance with IEC-60884-1, CEE7

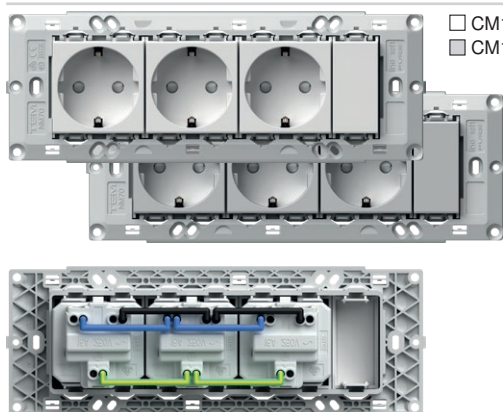
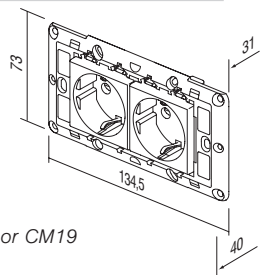

- CM11PW
- CM11ES

КОМПЛЕКТ КОНТАКТИ 3 x ШУКО 2P+E 16 A 250 V~ 7M

- комплект контакти 3 x шуко VM10 2P+E 16 A 250 V~
- предварително свързани съединителни проводници CM16
- с монтажна рамка 7M без винтове
- за закрепване към монтажна рамка използвайте винтове CM17, CM18 или CM19
- винтови контакти 1,5 - 2,5 mm²
- в съответствие с IEC 60884-1, CEE7

SOCKETS SET 3x SCHUKO 2P+E 16A 250V~ 7M

- socket set 3x schuko VM10 2P+E 16A 250V~
- prewired with link wires CM16
- with mounting frame 7M without screws
- for mounting frame fixing use screws CM17, CM18 or CM19
- screw contacts 1.5-2.5 mm²
- in accordance with IEC-60884-1, CEE7

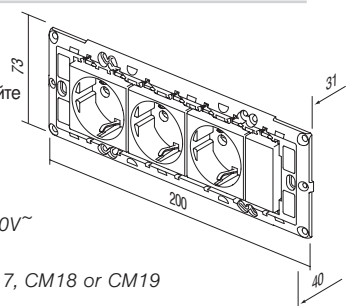

КОМПЛЕКТ СЪЕДИНИТЕЛНИ ПРОВОДНИЦИ 3 x 1,5 mm², 1M

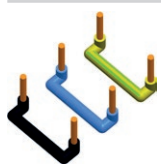

CM15

- комплект съединителни проводници за свързване на два елемента с размер 1M
- съдържа 10 черни, 10 сини и 10 жълти/зелени проводника

LINK WIRE SET 3x1.5mm² 1M

- link wire set to connect two elements size 1M
- includes 10 black, 10 blue and 10 yellow/green wires

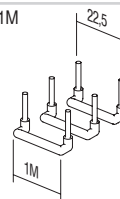

КОМПЛЕКТ СЪЕДИНИТЕЛНИ ПРОВОДНИЦИ 3 x 2,5 mm², 2M

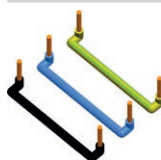

CM16

- комплект съединителни проводници за свързване на два елемента с размер 2M
- съдържа 10 черни, 10 сини и 10 жълти/зелени проводника

LINK WIRE SET 3x2.5mm² 2M

- link wire set to connect two elements size 2M
- includes 10 black, 10 blue and 10 yellow/green wires

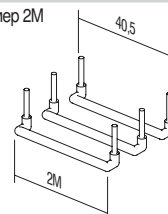

КОМПЛЕКТ ВИНТОВЕ 3,5

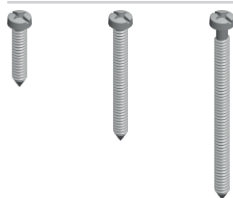

CM17

CM18

CM19

- адаптер за закрепване за монтажни рамки NM30, NM32, NM40, NM41, NM70
- CM17 - l=20 mm, 100 бр.
- CM18 - l=35 mm, 50 бр.
- CM19 - l=50mm, 50 бр.

SCREW SET 3,5

- screw set for fixing mounting frames NM30, NM32, NM40, NM41, NM70
- CM17 - l=20mm, 100pcs
- CM18 - l=35mm, 50pcs
- CM19 - l=50mm, 50pcs

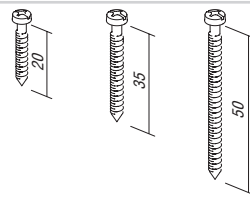

КОМПЛЕКТ КЛЮЧОВЕ IP44 2M



- CM22PW
- CM22SB
- CM22AT
- CM22ES
- CM22IW

- за използване във влажни зони
- предоставена защита IP44 за всички ключове Modul
- ключовете и бутоните не са част от комплекта
- панел SOFT 2M с надпис
- в съответствие с IEC 60669-1

SET SWITCHES IP44 2M

- for usage in humid areas
- IP44 protection provides for all Modul switches
- switches and buttons are not part of the set
- SOFT 2M cover plate with inscription plate
- in accordance with IEC 60669-1



КОМПЛЕКТ КОНТАКТИ IP44 2M



- CM23PW
- CM23SB
- CM23AT
- CM23ES
- CM23IW

- за използване във влажни зони
- защита IP44 може да се постигне само в комбинация с покрит контакт (VM11, VM41)
- контактите не са част от комплекта
- панел SOFT 2M с надпис
- в съответствие с IEC 60884-1

SET SOCKETS IP44 2M

- for usage in humid areas
- IP44 protection can be achieved only in combination with covered socket (VM11, VM41)
- sockets are not part of the set
- SOFT 2M cover plate with inscription plate
- in accordance with IEC 60884-1



КОМПЛЕКТ КЛЮЧОВЕ ЗА БАНЯ 3 x 20 A 250 V~ 4M

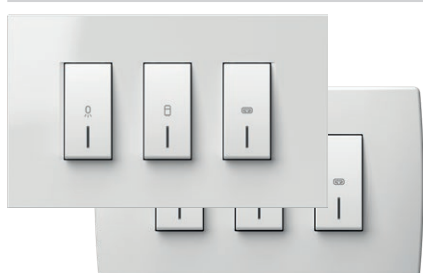

- CM25PWOL
- CM25IWOL
- CM25PWOS
- CM25IWOS

- комплект ключове 3 x SM12 20 A 250 V~ с монтажна рамка и панел
- винтови контакти 1,5 - 2,5 mm²
- в съответствие с EN 60669-1
- универсално решение за подновяване на конзоли с размери за закрепване 108-135 mm или конзоли размер 4M
- височина на панела 90 mm

SWITCH SET FOR BATHROOM 3x20A 250V~ 4M

- switch set 3xSM12 20A 250V~ with mounting frame and cover plate
- screw contacts 1.5-2.5mm²
- in accordance with EN 60669-1
- universal solution for renovation on boxes with fixing dimensions 108-135mm or boxes 4M size
- cover plate height 90mm

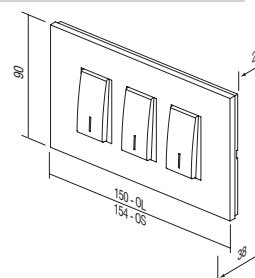

МОНТАЖНА РАМКА ЗА КОМПЛЕКТ ЗА БАНЯ 4М

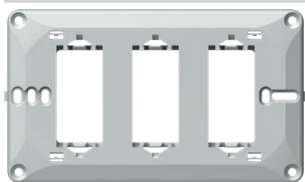

NM41

- универсална монтажна рамка за комплект за баня с винтове
- универсално решение за монтиране върху правоъгълни конзоли с размери за закрепване 108-135 mm или конзоли размер 4M
- в съответствие с EN 60669-1

MOUNTING FRAME BATHROOM SET 4M

- universal mounting frame for bathroom set with screws
- universal solution for mounting on rectangular boxes with fixing dimensions 108-135mm or boxes 4M size
- in accordance with EN 60669-1

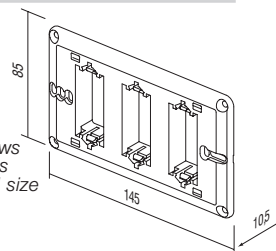

ПАНЕЛ LINE ЗА КОМПЛЕКТ ЗА БАНЯ



- | | |
|--|--------|
| | OL41PW |
| | OL41NB |
| | OL41IW |
| | OL41ES |
| | OL41SG |
| | OL41IB |
| | OL41AT |
| | OL41TI |
| | OL41SB |

- декоративен панел LINE за комплект за баня
- височина 90 mm
- в съответствие с EN 60669-1

COVER PLATE LINE BATHROOM SET

- decorative cover plate bathroom set LINE
- height 90mm
- in accordance with EN 60669-1

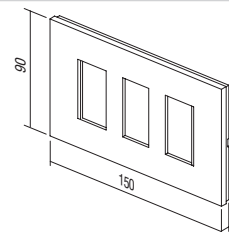

ПАНЕЛ SOFT ЗА КОМПЛЕКТ ЗА БАНЯ



- | | | | |
|--|--------|--|--------|
| | OS41PW | | OS41SB |
| | OS41NB | | OS41WE |
| | OS41IW | | OS41AT |
| | OS41ES | | OS41TI |
| | OS41SG | | |

- декоративен панел SOFT за комплект за баня
- височина 90 mm
- в съответствие с EN 60669-1

COVER PLATE SOFT BATHROOM SET

- decorative cover plate bathroom set SOFT
- height 90mm
- in accordance with EN 60669-1

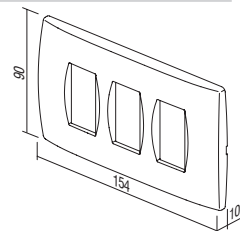

МОДУЛ ЗА АНТИБАКТЕРИАЛНА ПРОГРАМА

The diagram illustrates the antibacterial program module components. A hand is shown being washed under a faucet. Labels TM11, AW, and IN are placed above the hand and faucet area. Below the diagram is a table with columns: тип (type), описание (description), размер (size), цвят (colour), and допълнителна информация 1 (optional data 1).

тип type	описание description	размер size	цвят colour	допълнителна информация 1 optional data 1
TM11	БУТОН BUTTON	1M	<input type="checkbox"/> AW антибактериален, бял antibacterial white	NT неутрален neutral
TM21	КАПАЧЕ BLANK	1M		
VM10	КОНТАКТ SOCKET	2M		IN индикатор indicator
.	.	.		
.	.	.		
.	.	.		

МОДУЛ ЗА АНТИБАКТЕРИАЛНА ПРОГРАМА

- ключовете и контактите всеки ден се докосват от много хора, поради което са общо място за развитие и разпространение на бактерии
- благодарение на естествените си антибактериални свойства, среброто вече три хилядолетия се използва като безопасен и ефикасен дезинфектант, тъй като е напълно естествено, здравословно и не уврежда околната среда
- добавката със специални антибактериални йони осигурява дълготрайно надеждна и ефикасна защита против развитието и разпространението на бактерии, микроби и плесени
- антибактериалната защита осигурява поддържане хигиена, чистота и здраве
- антибактериалната програма MODUL е изключително подходяща за приложение в среда със строги изисквания за хигиена (болници, здравни центрове, фармацевтични обекти, домове за възрастни, приюти, лаборатории, ресторанти, хотели, летища, автобусни и железопътни станции, бизнес и търговски зони, обществени институции...)
- проведени са независими лабораторни изпитвания в съответствие с най-високите японски стандарти JIS Z 2801
- ниски разходи за подобряване на човешкото здраве
- структурата и функционалността на антибактериалната програма MODUL позволяват лесно почистване и поддръжка
- антибактериалните бутони, панели и контакти се комбинират с класически монтажни рамки и ключове
- продуктите са обозначени отзад с AW (антибактериален, бял)

ANTIBACTERIAL PROGRAM MODUL

- switches and sockets are daily touched by many people, so this is a common place for development and spread of bacteria
- thanks to its natural antibacterial characteristics silver has been used for three millennia as a safe and effective disinfectant, since it is completely natural, healthy and environmentally friendly
- special antibacterial silver ions additive provides long-term, reliable and effective protection against the development and spread of bacteria, microbes and fungi
- antibacterial protection ensures hygiene, cleanliness and health for people
- perfectly suitable for use in environments with strict hygiene conditions (hospitals, health centers, pharmaceutical facilities, homes for elderly, nursing homes, laboratories, restaurants, hotels, airports, bus and railway stations, business and shopping areas, public institutions ...)
- independent laboratory testings have been carried out in accordance with highest Japanese standards JIS Z 2801
- low cost for providing human health
- design and functionality of antibacterial program MODUL allow easy cleaning and maintenance
- antibacterial buttons, cover plates and sockets are combined with classic mounting frames and switches
- products are labelled on the back with AW (antibacterial white)

БУТОН 1М



□ TM11AW

- сменяем бутон 1М, в съответствие с EN 60669-1
- антибактериална защита в съответствие с изискванията по стандарт JIS Z 2801

BUTTON 1M

- replaceable button 1M
- in accordance with EN 60669-1
- antibacterial protection in accordance with JIS Z 2801



БУТОН 1М С ИНДИКАТОР



□ TM11AWIN

- сменяем бутон 1М, в съответствие с EN 60669-1
- антибактериална защита в съответствие с изискванията по стандарта JIS Z 2801

BUTTON 1M INDICATOR

- replaceable button 1M
- in accordance with EN 60669-1
- antibacterial protection in accordance with JIS Z 2801



БУТОН 2М



□ TM12AW

- сменяем бутон 2М с носач за бутон
- за надграждане на ключ или бутон от размер 1М към размер 2М
- в съответствие с EN 60669-1
- антибактериална защита в съответствие с изискванията по стандарт JIS Z 2801

BUTTON 2M

- replaceable button 2M with button carrier
- to upgrade switch or push button from size 1M to size 2M
- in accordance with EN 60669-1
- antibacterial protection in accordance with JIS Z 2801

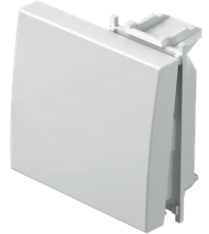

БУТОН 2М С ИНДИКАТОР



□ TM12AWIN

- сменяем бутон 2М с носач за бутон
- за надграждане на ключ или бутон от размер 1М към размер 2М
- в съответствие с EN 60669-1
- антибактериална защита в съответствие с изискванията по стандарт JIS Z 2801

BUTTON 2M INDICATOR

- replaceable button 2M with button carrier
- to upgrade switch or push button from size 1M to size 2M
- in accordance with EN 60669-1
- antibacterial protection in accordance with JIS Z 2801

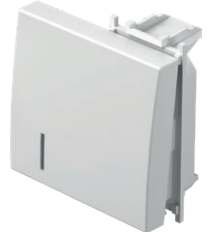

КАПАЧЕ 1М



□ TM21AW

- модулно капаче за покриване на неизползвани позиции
- в съответствие с EN 60669-1
- антибактериална защита в съответствие с изискванията по стандарт JIS Z 2801

BLANK 1M

- blank modul to fill up empty spaces
- in accordance with EN 60669-1
- antibacterial protection in accordance with JIS Z 2801



КАПАЧЕ 2М



□ TM22AW

- модулно капаче за покриване на неизползвани позиции
- в съответствие с EN 60669-1
- антибактериална защита в съответствие с изискванията по стандарт JIS Z 2801

BLANK 2M

- blank modul to fill up empty spaces
- in accordance with EN 60669-1
- antibacterial protection in accordance with JIS Z 2801





□ VM10AW

КОНТАКТ SCHUKO+KS 2P+E 16A 250V~ 2M

- 2P+E шуко, 16A 250V~, тип VM10
- в съответствие с IEC 60884-1, CEE7
- винтови контакти 1,5 - 2,5 mm²
- Вградена защита от допир на контакти
- антибактериална защита в съответствие с изискванията по стандарт JIS Z 2801

SOCKET SCHUKO+KS 2P+E 16A 250V~ 2M

- 2P+E schuko
- 16A 250V~, type VM10
- in accordance with IEC 60884-1, CEE7
- screw contacts 1.5-2.5 mm²
- shuttered live contacts
- antibacterial protection in accordance with JIS Z 2801



□ VM11AW

КОНТАКТ SCHUKO+KS+COVER 2P+E 16A 250V~ 2M

- 2P+E шуко+капак, 16A 250V~, тип VM11
- в съответствие с IEC 60884-1, CEE7
- винтови контакти 1,5 - 2,5 mm²
- Вградена защита от допир на контакти
- антибактериална защита в съответствие с изискванията по стандарт JIS Z 2801

SOCKET SCHUKO+KS+COVER

- 2P+E schuko+cover
- 16A 250V~, type VM11
- in accordance with IEC 60884-1, CEE7
- screw contacts 1.5-2.5 mm²
- shuttered live contacts
- antibacterial protection in accordance with JIS Z 2801



□ VM20AW

КОНТАКТ EURO+KS 2P 10 A 250 V~ 1M

- 2P Euro, 10 A 250 V~, тип VM20
- в съответствие с IEC 60884-1, CEE7
- винтови контакти 1,5 - 2,5 mm²
- Вградена защита от допир на контакти
- антибактериална защита в съответствие с изискванията по стандарт JIS Z 2801

SOCKET EURO+KS 2P 10A 250V~ 1M

- 2P Euro
- 10A 250V~, type VM20
- in accordance with IEC 60884-1, CEE7
- screw contacts 1.5-2.5 mm²
- shuttered live contacts
- antibacterial protection in accordance with JIS Z 2801



□ KM11AW

КОНЕКТОР ЗА ТВ КРАЕН 1 dB 1M

- контакт за ТВ краен
- честотен обхват 5÷2400 MHz, затихване < 1 dB
- в съответствие с EN 50083-1
- винтови контакти
- антибактериална защита в съответствие с изискванията по стандарт JIS Z 2801

SOCKET TV END-LINE 1dB 1M

- TV end-line
- frequency range 5÷2400 MHz
- reduction < 1 dB
- in accordance with EN 50083-1
- screw contacts
- antibacterial protection in accordance with JIS Z 2801

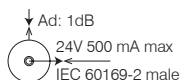

□ KM35AW

АДАПТЕР KS 1M

- KS модул стандарт за закрепване
- AMP, Avaya, Brandrex, FMT, Mfico, Tyco, ...
- комуникационният модул не е включен в доставката
- антибактериална защита в съответствие с изискванията по стандарт JIS Z 2801

ADAPTER KS 1M

- KS keystone fixing standard
- AMP, Avaya, Brandrex, FMT, Mfico, Tyco, ...
- communication module not included
- antibacterial protection in accordance with JIS Z 2801

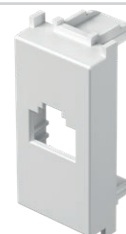



OS20AW

ПАНЕЛ SOFT 2M

- декоративен панел SOFT 2M
- в съответствие с EN 60669-1
- антибактериална защита в съответствие с изискванията по стандарт JIS Z 2801

COVER PLATE SOFT 2M

- decorative cover plate SOFT 2M
- in accordance with EN 60669-1
- antibacterial protection in accordance with JIS Z 2801



OS24AW

ПАНЕЛ SOFT 2x2M

- декоративен панел SOFT 2x2M
- хоризонтален или вертикален монтаж
- в съответствие с EN 60669-1
- антибактериална защита в съответствие с изискванията по стандарт JIS Z 2801

COVER PLATE SOFT 2x2M

- decorative cover plate SOFT 2x2M
- horizontal or vertical mounting
- in accordance with EN 60669-1
- antibacterial protection in accordance with JIS Z 2801



OS26AW

ПАНЕЛ SOFT 3x2M

- декоративен панел SOFT 3x2M
- хоризонтален или вертикален монтаж
- в съответствие с EN 60669-1
- антибактериална защита в съответствие с изискванията по стандарт JIS Z 2801

COVER PLATE SOFT 3x2M

- decorative cover plate SOFT 3x2M
- horizontal or vertical mounting
- in accordance with EN 60669-1
- antibacterial protection in accordance with JIS Z 2801



OS30AW

ПАНЕЛ SOFT 3M

- декоративен панел SOFT 3M
- в съответствие с EN 60669-1
- антибактериална защита в съответствие с изискванията по стандарт JIS Z 2801

COVER PLATE SOFT 3M

- decorative cover plate SOFT 3M
- in accordance with EN 60669-1
- antibacterial protection in accordance with JIS Z 2801



OS40AW

ПАНЕЛ SOFT 4M

- декоративен панел SOFT 4M
- в съответствие с EN 60669-1
- антибактериална защита в съответствие с изискванията по стандарт JIS Z 2801

COVER PLATE SOFT 4M

- decorative cover plate SOFT 4M
- in accordance with EN 60669-1
- antibacterial protection in accordance with JIS Z 2801

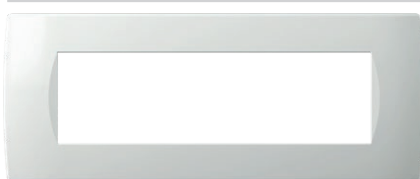

OS70AW

ПАНЕЛ SOFT 7M

- декоративен панел SOFT 7M
- в съответствие с EN 60669-1
- антибактериална защита в съответствие с изискванията по стандарт JIS Z 2801

COVER PLATE SOFT 7M

- decorative cover plate SOFT 7M
- in accordance with EN 60669-1
- antibacterial protection in accordance with JIS Z 2801

ДЪРВО
wood

WB бамбук
bamboo



WW орех
walnut



WM клен
maple



WE венге
wenge



Природата е уникална и прецизна, и сред нашите декоративни панели няма два еднакви.
Рекламации във връзка с разнообразния външен вид на дървени декоративни панели и различия не се приемат.

Nature is unique and precious, as our decorative cover plates where no two are the same.
Complaints about wooden decorative cover plate's diverse appearance and differentiation cannot be considered.

COVER PLATES PURE OP

МЕТАЛ
 metal

 MH ковано желязо
 hammered steel

 ME ецвано желязо
 etched iron

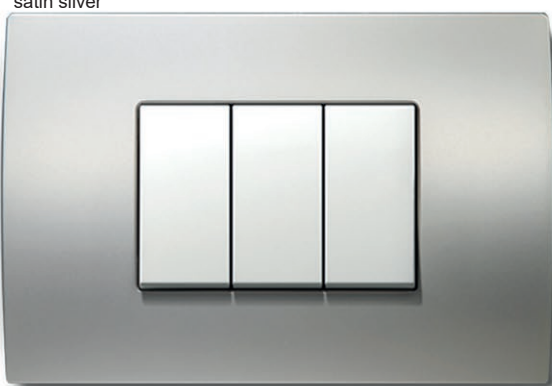
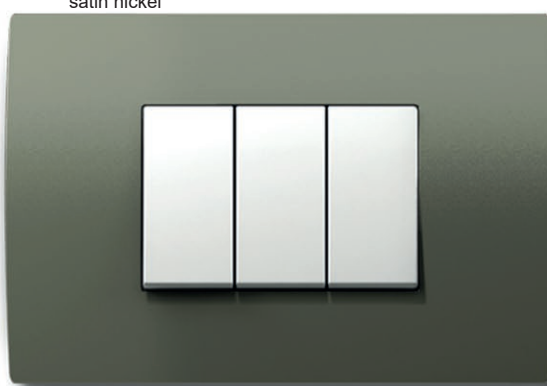
 MS матов сребрист цвят
 satin silver

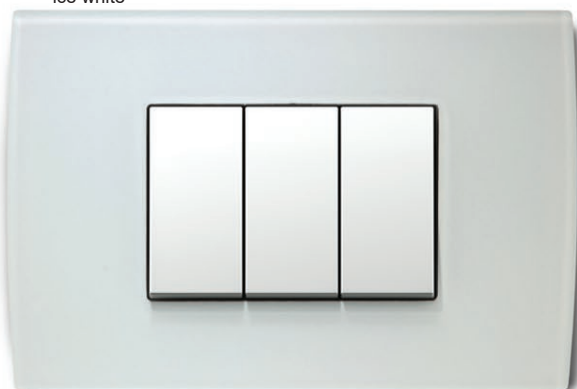
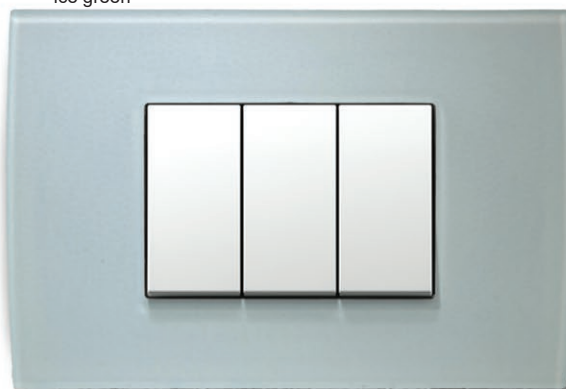
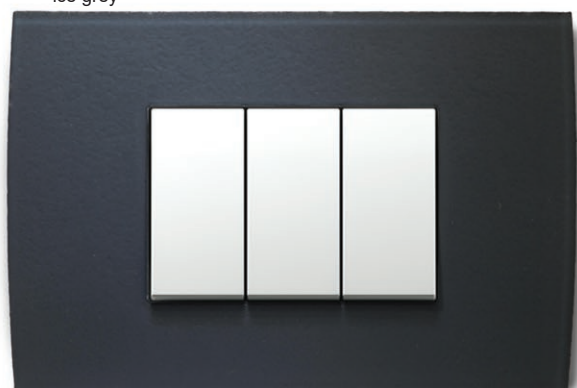
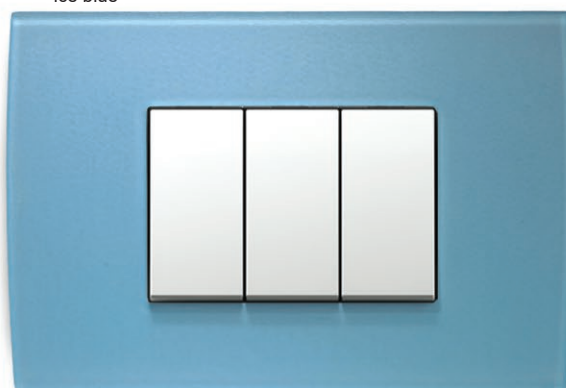
 MN матов никел
 satin nickel

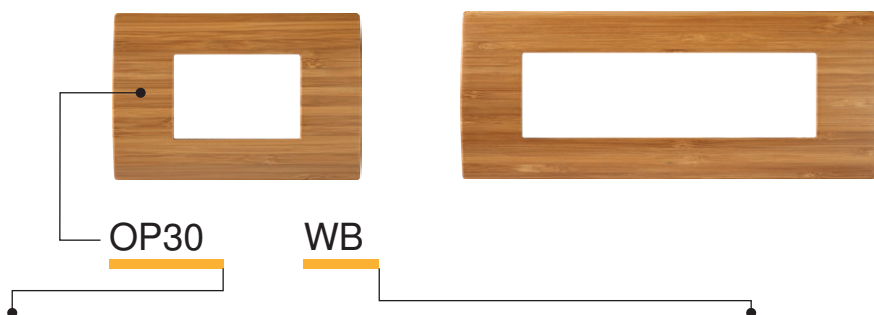
СТЪКЛО
 glass

 GW снежнобял цвят
 ice white

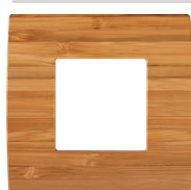
 GG снежнозелен
 ice green

 GY снежносив
 ice grey

 GB снежносин
 ice blue



тип type	описание description	размер size	цвет colour
OP13	ПАНЕЛ PURE COVER PLATE PURE	1/3M	MH ковано желязо hammered steel
OP20	ПАНЕЛ PURE COVER PLATE PURE	2M	ME ецвано желязо etched iron
OP23	ПАНЕЛ PURE COVER PLATE PURE	2/3M	MS матов сребрист цвет satin silver
.	.	.	MN матов никел satin nickel
.	.	.	WB бамбук bamboo
.	.	.	WW орех walnut
.	.	.	WM клен maple
.	.	.	WE венге wenge
.	.	.	GW снежнобял цвет ice white
.	.	.	GG снежнозелен ice green
.	.	.	GY снежносив ice grey
.	.	.	GB снежносин ice blue



MH	OP20MH	WB	OP20WB
ME	OP20ME	WW	OP20WW
MS	OP20MS	WM	OP20WM
MN	OP20MN	WE	OP20WE
		GW	OP20GW
		GG	OP20GG
		GY	OP20GY
		GB	OP20GB

ПАНЕЛ PURE 2M

- декоративен панел PURE 2M
- в съответствие с EN 60669-1
- само в комбинация с монтажна рамка NM24 или NM25

COVER PLATE PURE 2M

- decorative cover plate PURE 2M
- in accordance with EN 60669-1
- only in combination with mounting frame NM24 or NM25

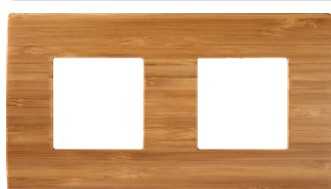

MH	OP24MH	WB	OP24WB
ME	OP24ME	WW	OP24WW
MS	OP24MS	WM	OP24WM
MN	OP24MN	WE	OP24WE
		GW	OP24GW
		GG	OP24GG
		GY	OP24GY
		GB	OP24GB

ПАНЕЛ PURE 2x2M

- декоративен панел PURE 2x2M
- хоризонтален или вертикален монтаж
- в съответствие с EN 60669-1
- само в комбинация с монтажна рамка NM24 или NM25

COVER PLATE PURE 2x2M

- decorative cover plate PURE 2x2M
- horizontal or vertical mounting
- in accordance with EN 60669-1
- only in combination with mounting frames NM24 or NM25



MH	OP26MH	WB	OP26WB
ME	OP26ME	WW	OP26WW
MS	OP26MS	WM	OP26WM
MN	OP26MN	WE	OP26WE
		GW	OP26GW
		GG	OP26GG
		GY	OP26GY
		GB	OP26GB

ПАНЕЛ PURE 3x2M

- декоративен панел PURE 3x2M
- хоризонтален или вертикален монтаж
- в съответствие с EN 60669-1
- само в комбинация с монтажна рамка NM24 или NM25

COVER PLATE PURE 3x2M

- decorative cover plate PURE 3x2M
- horizontal or vertical mounting
- in accordance with EN 60669-1
- only in combination with mounting frames NM24 or NM25



MH	OP28MH	WB	OP28WB
ME	OP28ME	WW	OP28WW
MS	OP28MS	WM	OP28WM
MN	OP28MN	WE	OP28WE
		GW	OP28GW
		GG	OP28GG
		GY	OP28GY
		GB	OP28GB

ПАНЕЛ PURE 4x2M

- декоративен панел PURE 4x2M
- хоризонтален или вертикален монтаж
- в съответствие с EN 60669-1
- само в комбинация с монтажна рамка NM24 или NM25

COVER PLATE PURE 4x2M

- decorative cover plate PURE 4x2M
- horizontal or vertical mounting
- in accordance with EN 60669-1
- only in combination with mounting frames NM24 or NM25

COVER PLATES PURE OP



	OP30MH		OP30WB
	OP30ME		OP30WW
	OP30MS		OP30WM
	OP30MN		OP30WE
			OP30GW
			OP30GG
			OP30GY
			OP30GB

ПАНЕЛ PURE 3M

- декоративен панел PURE 3M
- в съответствие с EN 60669-1

COVER PLATE PURE 3M

- decorative cover plate PURE 3M
- in accordance with EN 60669-1



	OP40MH		OP40WB
	OP40ME		OP40WW
	OP40MS		OP40WM
	OP40MN		OP40WE
			OP40GW
			OP40GG
			OP40GY
			OP40GB

ПАНЕЛ PURE 4M

- декоративен панел PURE 4M
- в съответствие с EN 60669-1

COVER PLATE PURE 4M

- decorative cover plate PURE 4M
- in accordance with EN 60669-1



	OP70MH		OP70WB
	OP70ME		OP70WW
	OP70MS		OP70WM
	OP70MN		OP70WE
			OP70GW
			OP70GG
			OP70GY
			OP70GB

ПАНЕЛ PURE 7M

- декоративен панел PURE 7M
- в съответствие с EN 60669-1

COVER PLATE PURE 7M

- decorative cover plate PURE 7M
- in accordance with EN 60669-1

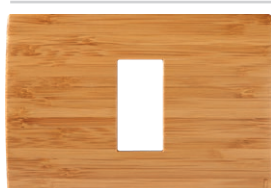

	OP13MH		OP13WB
	OP13ME		OP13WW
	OP13MS		OP13WM
	OP13MN		OP13WE
			OP13GW
			OP13GG
			OP13GY
			OP13GB

ПАНЕЛ PURE 1/3M

- декоративен панел PURE 1/3M
- в съответствие с EN 60669-1

COVER PLATE PURE 1/3M

- decorative cover plate PURE 1/3M
- in accordance with EN 60669-1

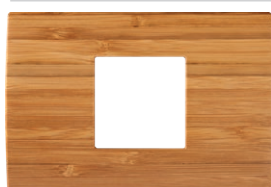

	OP23MH		OP23WB
	OP23ME		OP23WW
	OP23MS		OP23WM
	OP23MN		OP23WE
			OP23GW
			OP23GG
			OP23GY
			OP23GB

ПАНЕЛ PURE 2/3M

- декоративен панел PURE 2/3M
- в съответствие с EN 60669-1

COVER PLATE PURE 2/3M

- decorative cover plate PURE 2/3M
- in accordance with EN 60669-1

базов
basic

PW снежнобял цвят
polar white

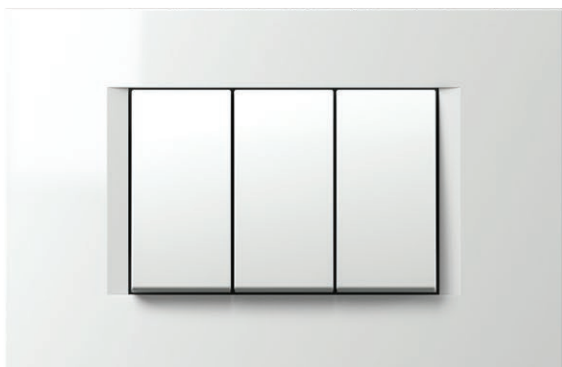

IW слонова кост
ivory white

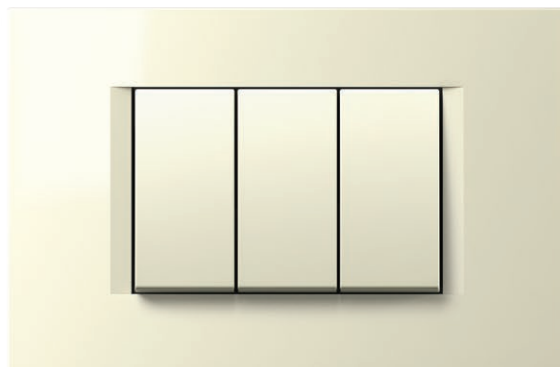

ES сребрист цвят с анодизирано покритие
elox silver



SB сензорен бутон, черен
soft touch black



AT антрацит
anthracite

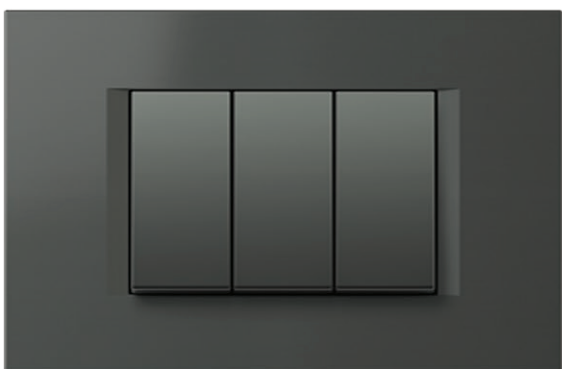

COVER PLATES LINE O L

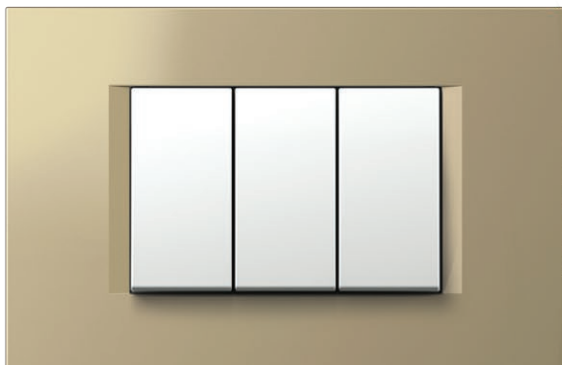
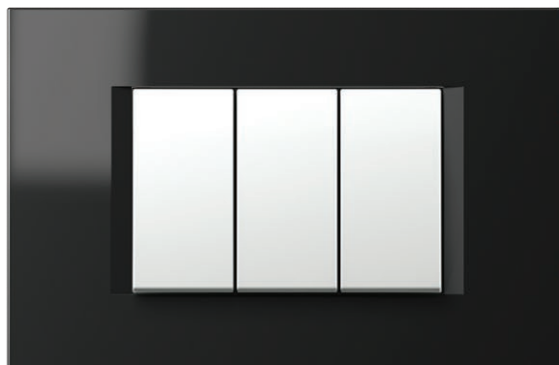
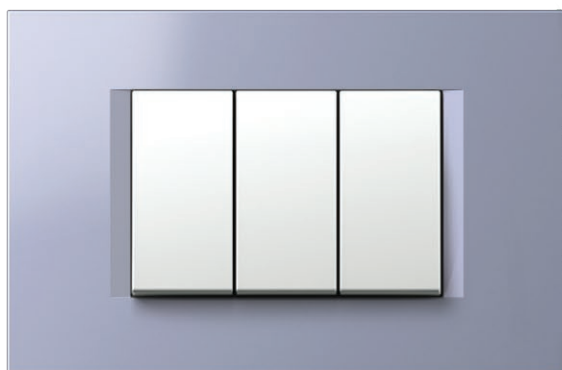
ДЕКОР
decorSG пясъчнозлатист
sand goldNB тъмночерен
night blackIB Импулно синьо
impulse blueTI титан
titaniumSW бял камък
stone white

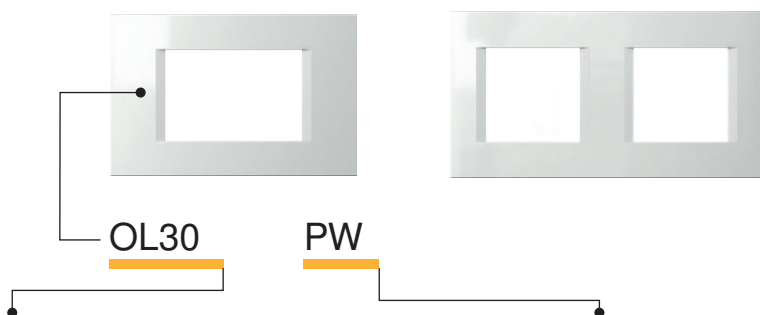

тип type	описание description	размер size	ЦВЯТ colour												
OL10	ПАНЕЛ LINE COVER PLATE LINE	1/2M	<table border="0"> <tr> <td></td> <td>PW</td> <td>снежнобял цвят polar white</td> </tr> <tr> <td></td> <td>SG</td> <td>пясъчнозлатист sand gold</td> </tr> <tr> <td></td> <td>AT</td> <td>антрацит anthracite</td> </tr> </table>		PW	снежнобял цвят polar white		SG	пясъчнозлатист sand gold		AT	антрацит anthracite			
	PW	снежнобял цвят polar white													
	SG	пясъчнозлатист sand gold													
	AT	антрацит anthracite													
OL13	ПАНЕЛ LINE COVER PLATE LINE	1/3M	<table border="0"> <tr> <td></td> <td>IW</td> <td>слонова кост ivory white</td> </tr> <tr> <td></td> <td>NB</td> <td>тъмночерен night black</td> </tr> <tr> <td></td> <td>TI</td> <td>титан titanium</td> </tr> </table>		IW	слонова кост ivory white		NB	тъмночерен night black		TI	титан titanium			
	IW	слонова кост ivory white													
	NB	тъмночерен night black													
	TI	титан titanium													
OL20	ПАНЕЛ LINE COVER PLATE LINE	2M	<table border="0"> <tr> <td></td> <td>ES</td> <td>сребрист цвят с анодизирано покритие elox silver</td> </tr> <tr> <td></td> <td>IB</td> <td>Импулсно синьо impulse blue</td> </tr> <tr> <td></td> <td>SW</td> <td>бял камък stone white</td> </tr> <tr> <td></td> <td>SB</td> <td>сензорен бутон, черен soft touch black</td> </tr> </table>		ES	сребрист цвят с анодизирано покритие elox silver		IB	Импулсно синьо impulse blue		SW	бял камък stone white		SB	сензорен бутон, черен soft touch black
	ES	сребрист цвят с анодизирано покритие elox silver													
	IB	Импулсно синьо impulse blue													
	SW	бял камък stone white													
	SB	сензорен бутон, черен soft touch black													
.	.	.	.												
.	.	.	.												



ПАНЕЛ LINE 2M



	OL20PW		OL20SG
	OL20IW		OL20NB
	OL20ES		OL20IB
	OL20SB		OL20AT
			OL20TI
			OL20SW

- декоративен панел LINE 2M
- в съответствие с EN 60669-1

COVER PLATE LINE 2M

- decorative cover plate LINE 2M
- in accordance with EN 60669-1

ПАНЕЛ LINE 2x2M

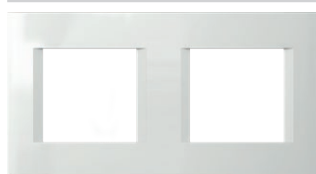

	OL24PW		OL24SG
	OL24IW		OL24NB
	OL24ES		OL24IB
	OL24SB		OL24AT
			OL24TI
			OL24SW

- декоративен панел LINE 2x2M
- хоризонтален или вертикален монтаж
- в съответствие с EN 60669-1

COVER PLATE LINE 2x2M

- decorative cover plate LINE 2x2M
- horizontal or vertical mounting
- in accordance with EN 60669-1

ПАНЕЛ LINE 3x2M

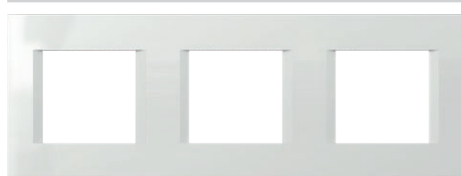

	OL26PW		OL26SG
	OL26IW		OL26NB
	OL26ES		OL26IB
	OL26SB		OL26AT
			OL26TI
			OL26SW

- декоративен панел LINE 3x2M
- хоризонтален или вертикален монтаж
- в съответствие с EN 60669-1

COVER PLATE LINE 3x2M

- decorative cover plate LINE 3x2M
- horizontal or vertical mounting
- in accordance with EN 60669-1

ПАНЕЛ LINE 4x2M



	OL28PW		OL28SG
	OL28IW		OL28NB
	OL28ES		OL28IB
	OL28SB		OL28AT
			OL28TI
			OL28SW

- декоративен панел LINE 4x2M
- хоризонтален или вертикален монтаж
- в съответствие с EN 60669-1

COVER PLATE LINE 4x2M

- decorative cover plate LINE 4x2M
- horizontal or vertical mounting
- in accordance with EN 60669-1

ПАНЕЛ LINE 5x2M

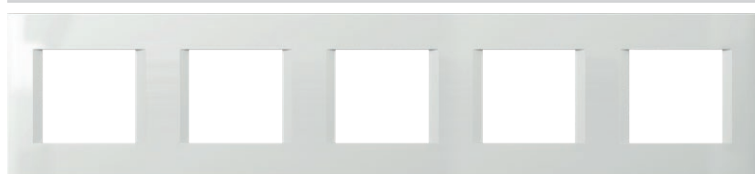

	OL29PW
	OL29IW
	OL29ES
	OL29SB
	OL29AT
	OL29TI

- декоративен панел LINE 5x2M
- хоризонтален или вертикален монтаж
- в съответствие с EN 60669-1

COVER PLATE LINE 5x2M

- decorative cover plate LINE 5x2M
- horizontal or vertical mounting
- in accordance with EN 60669-1

COVER PLATES LINE OL



	OL30PW		OL30SG
	OL30IW		OL30NB
	OL30ES		OL30IB
	OL30SB		OL30AT
			OL30TI
			OL30SW

ПАНЕЛ LINE 3M

- декоративен панел LINE 3M
- в съответствие с EN 60669-1

COVER PLATE LINE 3M
- decorative cover plate LINE 3M
- in accordance with EN 60669-1

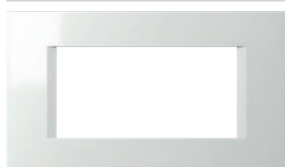

	OL40PW		OL40SG
	OL40IW		OL40NB
	OL40ES		OL40IB
	OL40SB		OL40AT
			OL40TI
			OL40SW

ПАНЕЛ LINE 4M

- декоративен панел LINE 4M
- в съответствие с EN 60669-1

COVER PLATE LINE 4M
- decorative cover plate LINE 4M
- in accordance with EN 60669-1

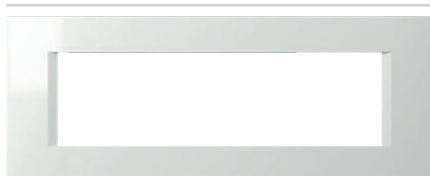

	OL70PW		OL70SG
	OL70IW		OL70NB
	OL70ES		OL70IB
	OL70SB		OL70AT
			OL70TI
			OL70SW

ПАНЕЛ LINE 7M

- декоративен панел LINE 7M
- в съответствие с EN 60669-1

COVER PLATE LINE 7M
- decorative cover plate LINE 7M
- in accordance with EN 60669-1



	OL10PW		OL10SG
	OL10IW		OL10NB
	OL10ES		OL10IB
	OL10SB		OL10AT
			OL10TI
			OL10SW

ПАНЕЛ LINE 1/2M

- декоративен панел LINE 1/2M
- в съответствие с EN 60669-1

COVER PLATE LINE 1/2M
- decorative cover plate LINE 1/2M
- in accordance with EN 60669-1

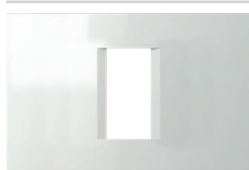

	OL13PW		OL13SG
	OL13IW		OL13NB
	OL13ES		OL13IB
	OL13SB		OL13AT
			OL13TI
			OL13SW

ПАНЕЛ LINE 1/3M

- декоративен панел LINE 1/3M
- в съответствие с EN 60669-1

COVER PLATE LINE 1/3M
- decorative cover plate LINE 1/3M
- in accordance with EN 60669-1



	OL23PW		OL23SG
	OL23IW		OL23NB
	OL23ES		OL23IB
	OL23SB		OL23AT
			OL23TI
			OL23SW

ПАНЕЛ LINE 2/3M

- декоративен панел LINE 2/3M
- в съответствие с EN 60669-1

COVER PLATE LINE 2/3M
- decorative cover plate LINE 2/3M
- in accordance with EN 60669-1

базов
basic

PW снежнобял цвят
polar white

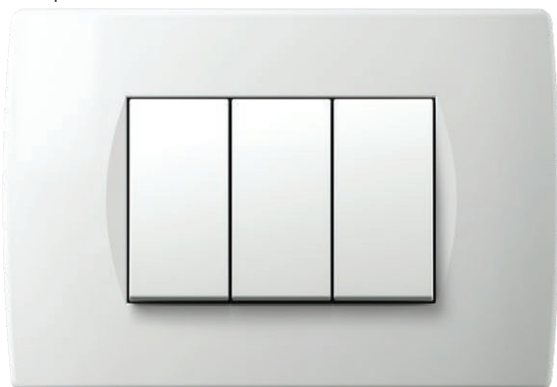

IW слонова кост
ivory white

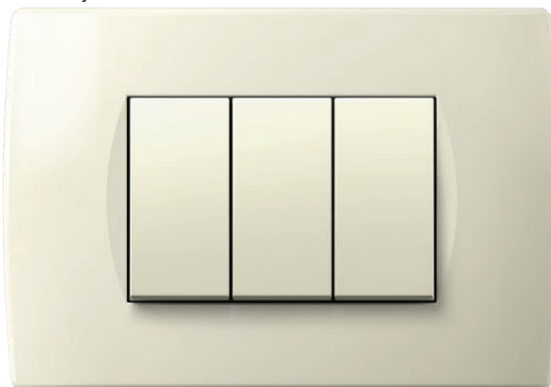

ES сребрист цвят с анодизирано покритие
elox silver

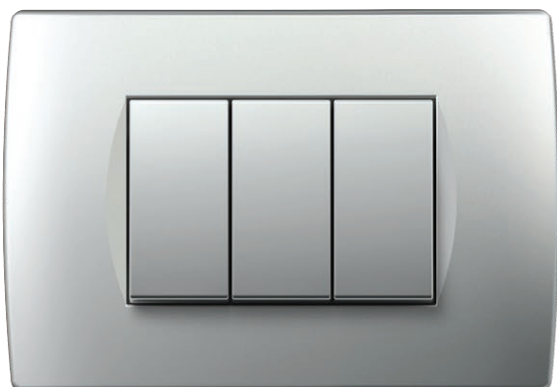

SB сензорен бутон, черен
soft touch black

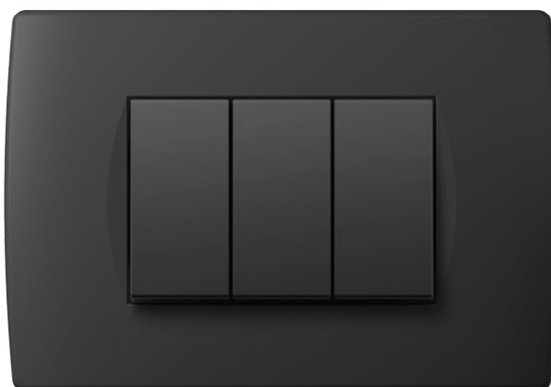

AT антрацит
anthracite

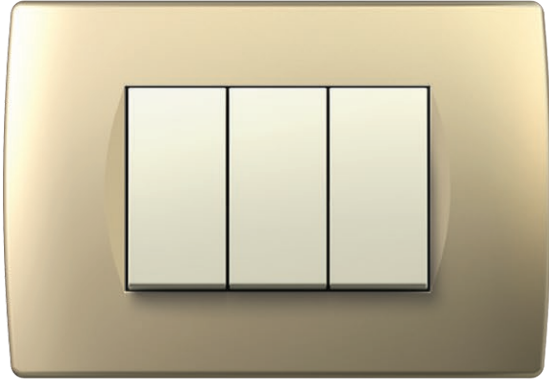
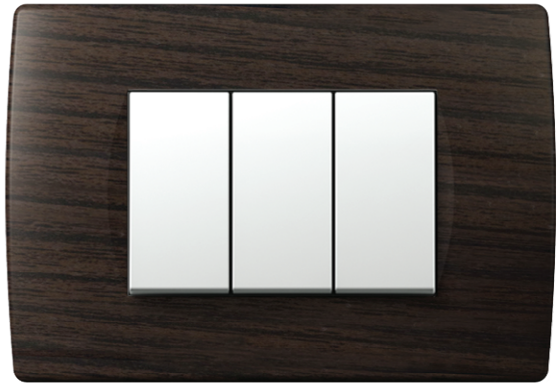

COVER PLATES SOFT OS

декор
decorSG пясъчнозлатист
sand goldNB тъмночерен
night blackTI титан
titaniumWE венге
wengeWW орех
walnut

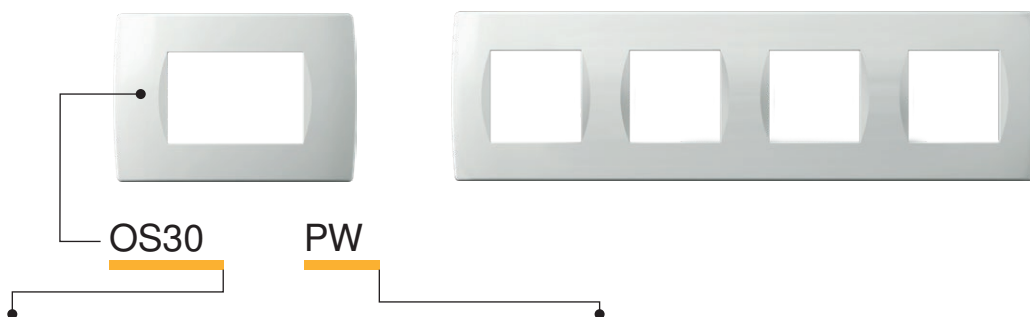

тип type	описание description	размер size	цвет colour																		
OS10	ПАНЕЛ SOFT COVER PLATE SOFT	1/2M	<table border="0"> <tr> <td></td> <td>PW</td> <td>снежнобял цвят polar white</td> <td></td> <td>SG</td> <td>пясъчнозлатист sand gold</td> <td></td> <td>WW</td> <td>орех walnut</td> </tr> </table>		PW	снежнобял цвят polar white		SG	пясъчнозлатист sand gold		WW	орех walnut									
	PW	снежнобял цвят polar white		SG	пясъчнозлатист sand gold		WW	орех walnut													
OS13	ПАНЕЛ SOFT COVER PLATE SOFT	1/3M	<table border="0"> <tr> <td></td> <td>IW</td> <td>слонова кост ivory white</td> <td></td> <td>NB</td> <td>тъмночерен night black</td> <td></td> <td>WE</td> <td>венге wenge</td> </tr> </table>		IW	слонова кост ivory white		NB	тъмночерен night black		WE	венге wenge									
	IW	слонова кост ivory white		NB	тъмночерен night black		WE	венге wenge													
OS20	ПАНЕЛ SOFT COVER PLATE SOFT	2M	<table border="0"> <tr> <td></td> <td>ES</td> <td>анодизирано покритие elox silver</td> <td></td> <td>AT</td> <td>антрацит anthracite</td> <td></td> <td>TI</td> <td>титан titanium</td> </tr> <tr> <td></td> <td>SB</td> <td>сензорен бутон, черен soft touch black</td> <td></td> <td></td> <td></td> <td></td> <td></td> <td></td> </tr> </table>		ES	анодизирано покритие elox silver		AT	антрацит anthracite		TI	титан titanium		SB	сензорен бутон, черен soft touch black						
	ES	анодизирано покритие elox silver		AT	антрацит anthracite		TI	титан titanium													
	SB	сензорен бутон, черен soft touch black																			
...																		



ПАНЕЛ SOFT 2M



	OS20PW		OS20SG
	OS20IW		OS20NB
	OS20ES		OS20AT
	OS20SB		OS20TI
			OS20WW
			OS20WE

- декоративен панел SOFT 2M
- в съответствие с EN 60669-1

COVER PLATE SOFT 2M
- decorative cover plate SOFT 2M
- in accordance with EN 60669-1

ПАНЕЛ SOFT 2x2M



	OS24PW		OS24SG
	OS24IW		OS24NB
	OS24ES		OS24AT
	OS24SB		OS24TI
			OS24WW
			OS24WE

- декоративен панел SOFT 2x2M
- хоризонтален или вертикален монтаж
- в съответствие с EN 60669-1

COVER PLATE SOFT 2x2M
- decorative cover plate SOFT 2x2M
- horizontal or vertical mounting
- in accordance with EN 60669-1

ПАНЕЛ SOFT 3x2M



	OS26PW		OS26SG
	OS26IW		OS26NB
	OS26ES		OS26AT
	OS26SB		OS26TI
			OS26WW
			OS26WE

- декоративен панел SOFT 3x2M
- хоризонтален или вертикален монтаж
- в съответствие с EN 60669-1

COVER PLATE SOFT 3x2M
- decorative cover plate SOFT 3x2M
- horizontal or vertical mounting
- in accordance with EN 60669-1

ПАНЕЛ SOFT 4x2M





	OS28PW		OS28SG
	OS28IW		OS28NB
	OS28ES		OS28AT
	OS28SB		OS28TI
			OS28WW
			OS28WE

- декоративен панел SOFT 4x2M
- хоризонтален или вертикален монтаж
- в съответствие с EN 60669-1

COVER PLATE SOFT 4x2M
- decorative cover plate SOFT 4x2M
- horizontal or vertical mounting
- in accordance with EN 60669-1

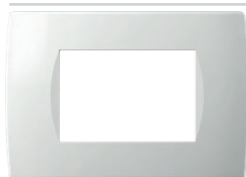
COVER PLATES SOFT OS



 OS30PW	 OS30SG
 OS30IW	 OS30NB
 OS30ES	 OS30AT
 OS30SB	 OS30TI
	 OS30WW
	 OS30WE

ПАНЕЛ SOFT 3M

- декоративен панел SOFT 3M
- в съответствие с EN 60669-1

COVER PLATE SOFT 3M

- decorative cover plate SOFT 3M
- in accordance with EN 60669-1



 OS40PW	 OS40SG
 OS40IW	 OS40NB
 OS40ES	 OS40AT
 OS40SB	 OS40TI
	 OS40WW
	 OS40WE

ПАНЕЛ SOFT 4M

- декоративен панел SOFT 4M
- в съответствие с EN 60669-1

COVER PLATE SOFT 4M

- decorative cover plate SOFT 4M
- in accordance with EN 60669-1

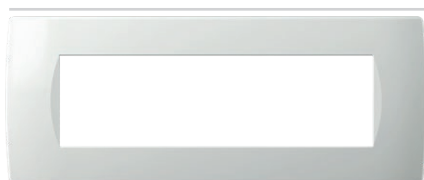

 OS70PW	 OS70SG
 OS70IW	 OS70NB
 OS70ES	 OS70AT
 OS70SB	 OS70TI
	 OS70WW
	 OS70WE







ПАНЕЛ SOFT 7M

- декоративен панел SOFT 7M
- в съответствие с EN 60669-1

COVER PLATE SOFT 7M

- decorative cover plate SOFT 7M
- in accordance with EN 60669-1



 OS72PW	 OS72AT
 OS72IW	 OS72TI
 OS72ES	
 OS72SB	



ПАНЕЛ SOFT 2x7M

- декоративен панел SOFT 2x7M
панел с надпис
- в съответствие с EN 60669-1

COVER PLATE SOFT 2x7M

- decorative cover plate SOFT 2x7M
with inscription plate
- in accordance with EN 60669-1



 OS10PW	 OS10SG
 OS10IW	 OS10NB
 OS10ES	 OS10AT
 OS10SB	 OS10TI
	 OS10WW
	 OS10WE









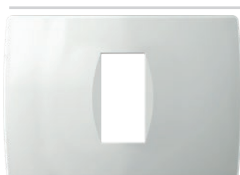

ПАНЕЛ SOFT 1/2M

- декоративен панел SOFT 1/2M
- в съответствие с EN 60669-1

COVER PLATE SOFT 1/2M

- decorative cover plate SOFT 1/2M
- in accordance with EN 60669-1



 OS13PW	 OS13SG
 OS13IW	 OS13NB
 OS13ES	 OS13AT
 OS13SB	 OS13TI
	 OS13WW
	 OS13WE







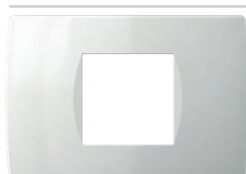

ПАНЕЛ SOFT 1/3M

- декоративен панел SOFT 1/3M
- в съответствие с EN 60669-1

COVER PLATE SOFT 1/3M

- decorative cover plate SOFT 1/3M
- in accordance with EN 60669-1



 OS23PW	 OS23SG
 OS23IW	 OS23NB
 OS23ES	 OS23AT
 OS23SB	 OS23TI
	 OS23WW
	 OS23WE

ПАНЕЛ SOFT 2/3M

- декоративен панел SOFT 2/3M
- в съответствие с EN 60669-1

COVER PLATE SOFT 2/3M

- decorative cover plate SOFT 2/3M
- in accordance with EN 60669-1

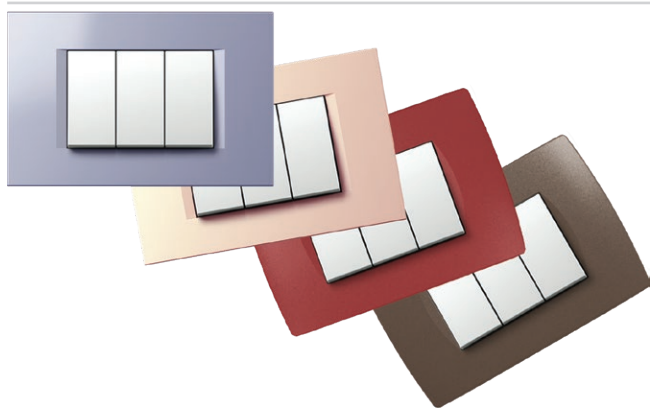









ДЕКОРИРАНЕ НА ПАНЕЛИ

- когато поръчвате големи количества, декоративните панели могат да бъдат изработени в изборния от вас цвят
- подходящо за панели OL, OS

COVER PLATES DECORATIONS

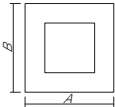
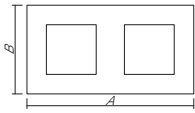
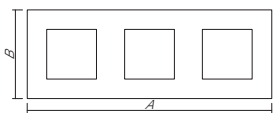
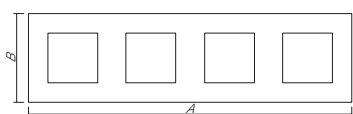
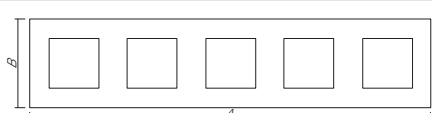
- when ordering large quantities, cover plates can be made in the colour of your choice
- suitable for cover plates OL, OS

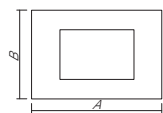
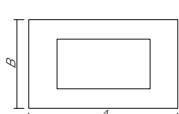
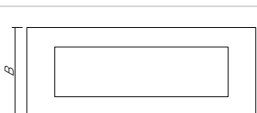
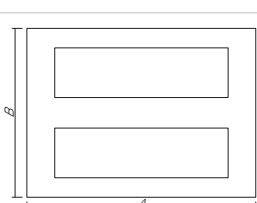
F R A M E S

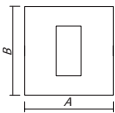
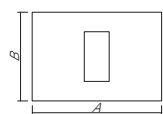
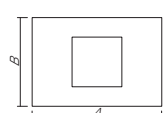
		 MODUL LINE A x B	 MODUL SOFT A x B	 MODUL PURE A x B
				
2M		80 x 80 mm	84 x 84 mm	93 x 90 mm
2x2M		151 x 80 mm	155 x 84 mm	164 x 90 mm
3x2M		222 x 80 mm	226 x 84 mm	235 x 90 mm
4x2M		293 x 80 mm	297 x 84 mm	304 x 90 mm
5x2M		364,1 x 80 mm		
				
3M		122 x 80 mm	122 x 84 mm	134 x 90 mm
4M		149 x 80 mm	144 x 84 mm	157 x 90 mm
7M		207 x 80 mm	212 x 84 mm	224 x 90 mm
2x7M			212 x 158 mm	
				
1/2M		80 x 80 mm	84 x 84 mm	
1/3M		122 x 80 mm	122 x 84 mm	134 x 90 mm
2/3M		122 x 80 mm	122 x 84 mm	134 x 90 mm

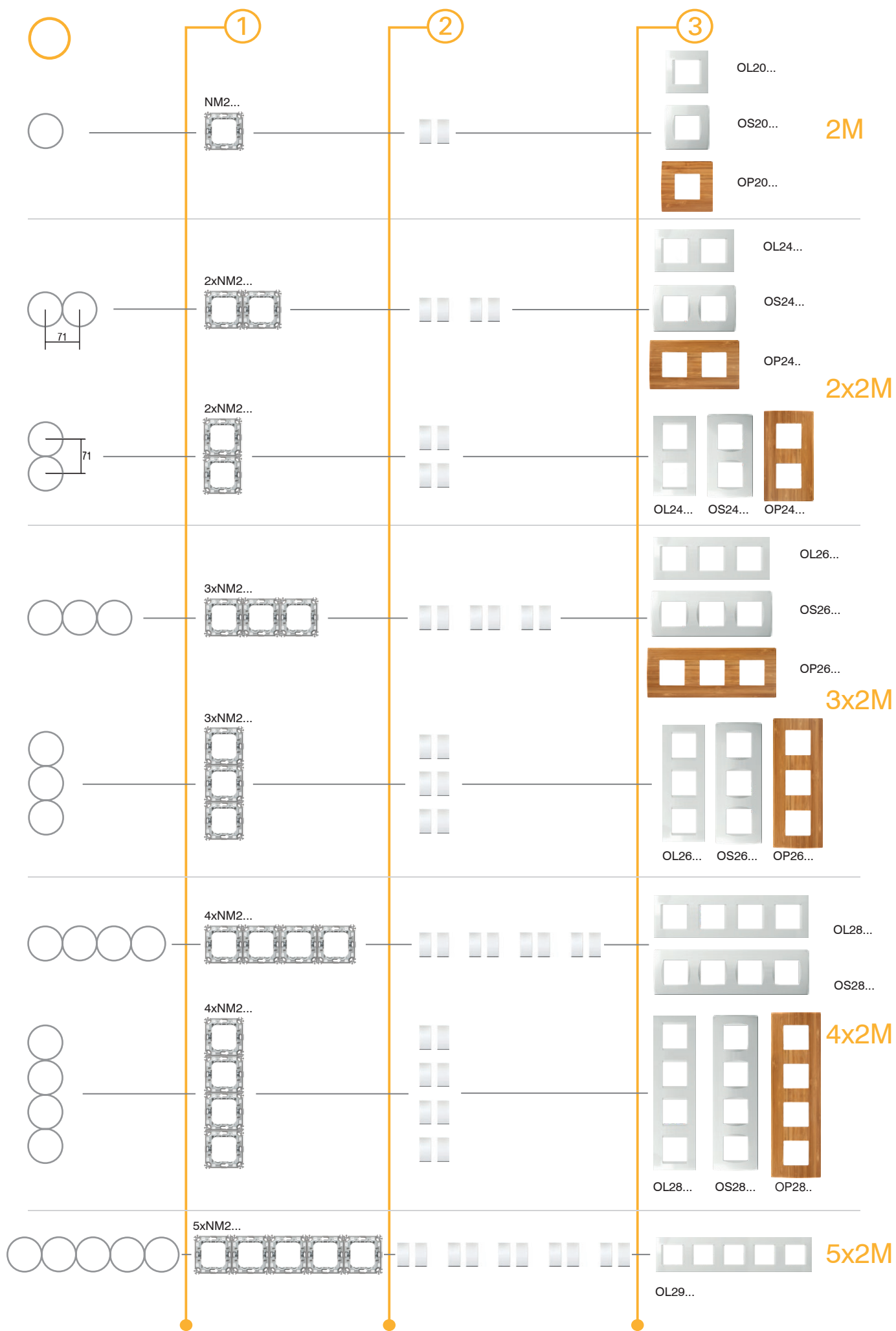

C O M B I N A T I O N S

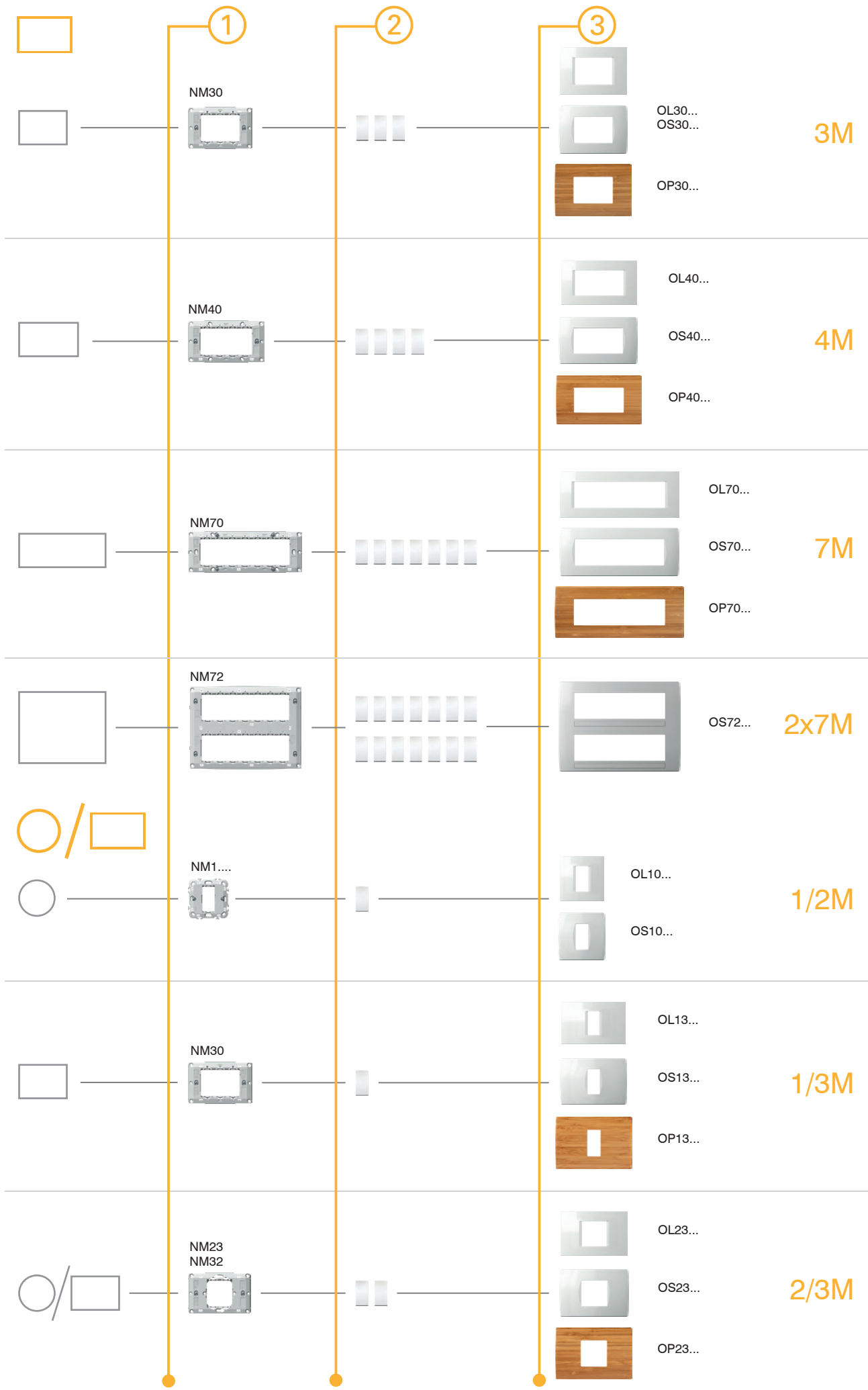

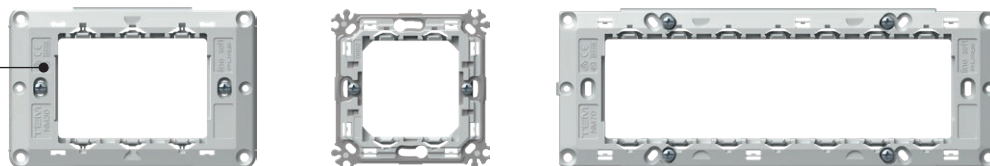

NM30

тип type	описание description	размер size
NM10	МОНТАЖНА РАМКА С ЩИПКИ MOUNTING FRAME WITH CLAWS	1/2M
NM11	МОНТАЖНА РАМКА БЕЗ ВИНТОВЕ MOUNTING FRAME WITHOUT SCREWS	1/2M
NM20	МОНТАЖНА РАМКА С ЩИПКИ MOUNTING FRAME WITH CLAWS	2M
...



МОНТАЖНА РАМКА С ЩИПКИ 2M

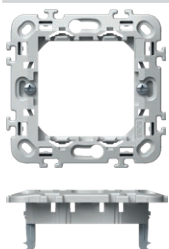

NM20

- монтаж на рамка 2M с крачета
- за монтаж на конзоли Ø60 (DE.) с крачета
- възможни са хоризонтални или вертикални комбинации 2x2M, 3x2M и 4x2M
- подходяща за слобяване с панели LINE и SOFT
- в съответствие с EN 60669-1

MOUNTING FRAME WITH CLAWS 2M

- mounting frame 2M with claws
- for mounting on boxes Ø60 (DE..) with claws
- possible horizontal or vertical combinations 2x2M, 3x2M and 4x2M
- suitable for assembling with cover plates LINE and SOFT
- in accordance with EN 60669-1

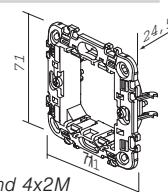

МОНТАЖНА РАМКА БЕЗ ВИНТОВЕ 2M

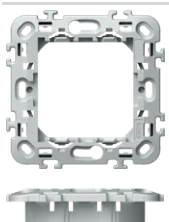

NM21

- монтаж на рамка 2M без винтове и без крачета
- за монтаж на конзоли Ø60 (HE., BE.) с винтове
- възможни са хоризонтални или вертикални комбинации 2x2M, 3x2M и 4x2M
- подходяща за слобяване с панели LINE и SOFT
- в съответствие с EN 60669-1

MOUNTING FRAME WITHOUT SCREWS 2M

- mounting frame 2M without screws and without claws
- for mounting on boxes Ø60 (HE..., BE..) with screws
- possible horizontal or vertical combinations 2x2M, 3x2M and 4x2M
- suitable for assembling with cover plates LINE and SOFT
- in accordance with EN 60669-1

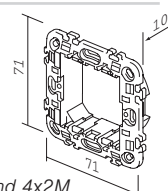

МЕТАЛНА МОНТАЖНА РАМКА С ЩИПКИ 2M

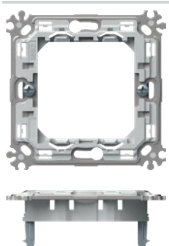

NM24

- метална монтажна рамка 2M с крачета – твърда версия
- за монтаж на конзоли Ø60 (DE.) с крачета
- възможни са хоризонтални или вертикални комбинации 2x2M, 3x2M и 4x2M
- подходяща за слобяване с панели PURE, LINE и SOFT
- в съответствие с EN 60669-1

MOUNTING FRAME METAL WITH CLAWS 2M

- metal mounting frame 2M with claws - stiff version
- for mounting on boxes Ø60 (DE..) with claws
- possible horizontal or vertical combinations 2x2M, 3x2M and 4x2M
- suitable for assembling with cover plates PURE, LINE and SOFT
- in accordance with EN 60669-1

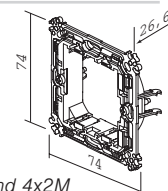

МЕТАЛНА МОНТАЖНА РАМКА БЕЗ ВИНТОВЕ 2M

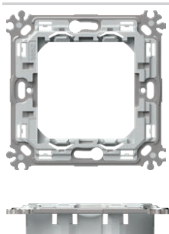

NM25

- метална монтажна рамка без винтове и без крачета – твърда версия
- за монтаж в конзоли Ø60 (HE..., BE...) с винтове
- възможни са хоризонтални или вертикални комбинации 2x2M, 3x2M и 4x2M
- подходяща за слобяване с панели PURE, LINE и SOFT
- в съответствие с EN 60669-1

MOUNTING FRAME METAL WITHOUT SCREWS 2M

- metal mounting frame 2M without screws and without claws - stiff version
- for mounting in boxes Ø60 (HE..., BE...) with screws
- possible horizontal or vertical combinations 2x2M, 3x2M and 4x2M
- suitable for assembling with cover plates PURE, LINE and SOFT
- in accordance with EN 60669-1

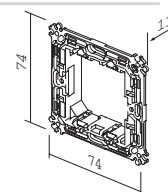

M O U N T I N G F R A M E S N M

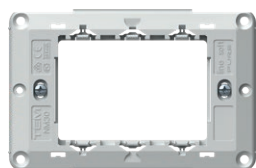

NM30

МОНТАЖНА РАМКА С ВИНТОВЕ 3М

- монтажна рамка 3М с винтове
- за монтаж в правоъгълни конзоли 3М
- подходяща за сглобяване с панели PURE, LINE и SOFT
- в съответствие с EN 60669-1

MOUNTING FRAME WITH SCREWS 3M

- mounting frame 3M with screws
- for mounting on rectangular boxes 3M
- suitable for assembling with cover plates PURE, LINE and SOFT
- in accordance with EN 60669-1

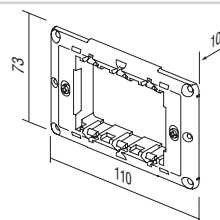

NM40

МОНТАЖНА РАМКА С ВИНТОВЕ 4М

- монтажна рамка 4М с винтове
- за монтаж в правоъгълни конзоли 4М
- подходяща за сглобяване с панели PURE, LINE и SOFT
- в съответствие с EN 60669-1

MOUNTING FRAME WITH SCREWS 4M

- mounting frame 4M with screws
- for mounting on rectangular boxes 4M
- suitable for assembling with cover plates PURE, LINE and SOFT
- in accordance with EN 60669-1

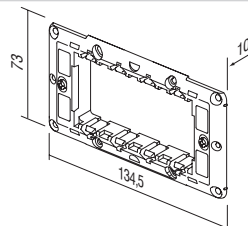

NM70

МОНТАЖНА РАМКА С ВИНТОВЕ 7М

- монтажна рамка 7М с винтове
- за монтаж в правоъгълни конзоли 7М
- подходяща за сглобяване с панели PURE, LINE и SOFT
- в съответствие с EN 60669-1

MOUNTING FRAME WITH SCREWS 7M

- mounting frame 7M with screws
- for mounting on rectangular boxes 7M
- suitable for assembling with cover plates PURE, LINE and SOFT
- in accordance with EN 60669-1

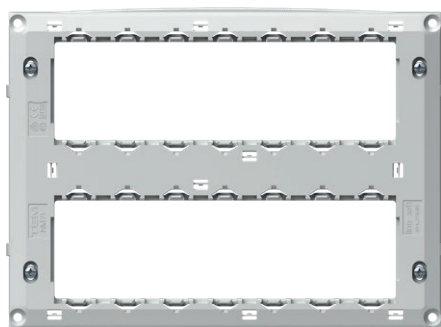
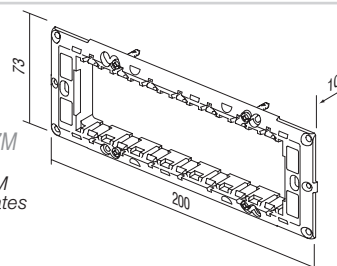

NM72

МОНТАЖНА РАМКА С ВИНТОВЕ 2x7М

- монтажна рамка с винтове 2x7М
- за монтаж в правоъгълни конзоли 2x7М
- подходяща за сглобяване с панел SOFT OS72
- в съответствие с EN 60669-1

MOUNTING FRAME WITH SCREWS 2x7M

- mounting frame 2x7M with screws
- for mounting on rectangular boxes 2x7M
- suitable for assembling with cover plate SOFT OS72
- in accordance with EN 60669-1

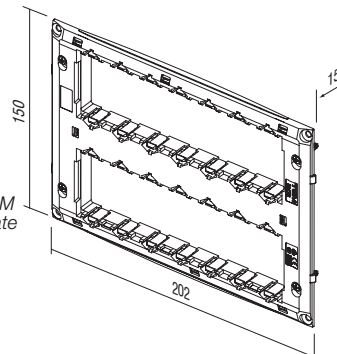



МОНТАЖНА РАМКА С ЩИПКИ 1/2М

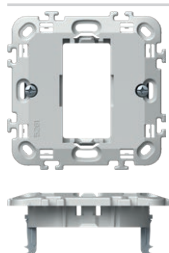

NM10

- монтажна рамка 1/2М с крачета
- за монтаж на конзоли Ø60 (DE.) с крачета
- подходяща за сглобяване с панели LINE и SOFT
- в съответствие с EN 60669-1

MOUNTING FRAME WITH CLAWS 1/2M

- mounting frame 1/2M with claws
- for mounting on boxes Ø60 (DE..) with claws
- suitable for assembling with cover plates LINE and SOFT
- in accordance with EN 60669-1

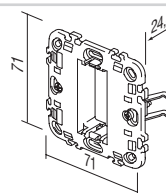

МОНТАЖНА РАМКА БЕЗ ВИНТОВЕ 1/2М

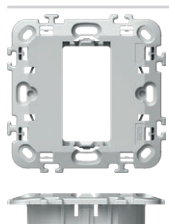

NM11

- монтажна рамка 1/2М без винтове и без крачета
- за монтаж на конзоли Ø60 (HE., BE.) с винтове
- подходяща за сглобяване с панели LINE и SOFT
- в съответствие с EN 60669-1

MOUNTING FRAME WITHOUT SCREWS 1/2M

- mounting frame 1/2M without screws and without claws
- for mounting on boxes Ø60 (HE., BE..) with screws
- suitable for assembling with cover plates LINE and SOFT
- in accordance with EN 60669-1

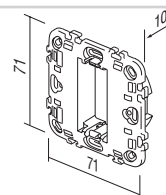

МОНТАЖНА РАМКА С ЩИПКИ 2/3М

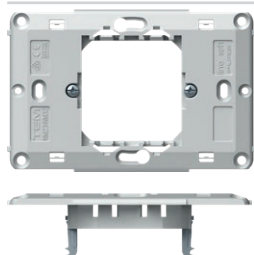

NM23

- монтажна рамка 2/3М с крачета
- за монтаж на конзоли Ø60 (DE.) с крачета
- подходяща за сглобяване с панели PURE, LINE и SOFT
- в съответствие с EN 60669-1

MOUNTING FRAME WITH CLAWS 2/3M

- mounting frame 2/3M with claws
- for mounting on boxes Ø60 (DE..) with claws
- suitable for assembling with cover plates PURE, LINE and SOFT
- in accordance with EN 60669-1

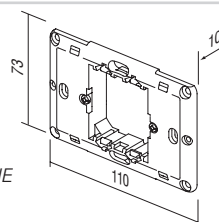

МОНТАЖНА РАМКА С ВИНТОВЕ 2/3М

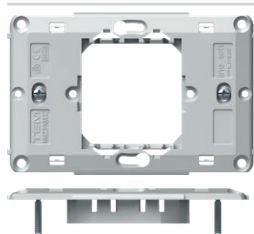

NM32

- монтажна рамка 2/3М с винтове
- за монтаж в правоъгълни конзоли 3М
- подходяща за сглобяване с панели PURE, LINE и SOFT
- в съответствие с EN 60669-1

MOUNTING FRAME WITH SCREWS 2/3M

- mounting frame 2/3M with screws
- for mounting on rectangular boxes 3M
- suitable for assembling with cover plates PURE, LINE and SOFT
- in accordance with EN 60669-1

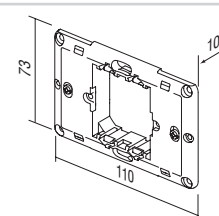



110



118



126



128





КУТТИ

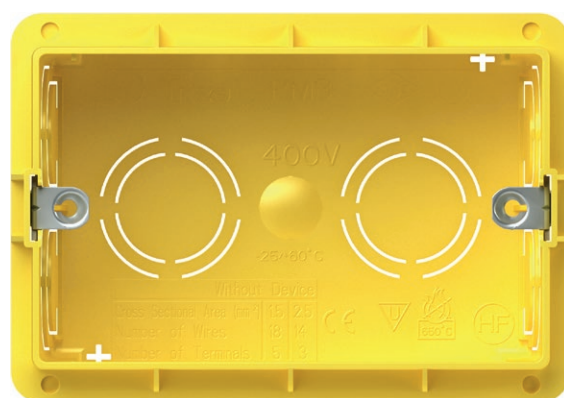

TEM



DE12



HE11



BE10

тип type	описание description	размер size
DE10	КРЪГЛИ КОНЗОЛИ ЗА ТУХЛЕНИ СТЕНИ ROUND BOX BRICK	SM60-01
HE10	КРЪГЛИ КОНЗОЛИ ЗА КУХИ СТЕНИ ROUND BOX HOLLOW WALL	SM68X40
BE10	КРЪГЛИ КОНЗОЛИ ЗА СТЕНИ ОТ БЕТОН ROUND BOX CONCRETE	
·	·	·
·	·	·

КРЪГЛИ КОНЗОЛИ ЗА ТУХЛЕНИ СТЕНИ SM60-01



DE10

- Ø60, дълбочина 40 mm
- 650° C, 500 V~
- в съответствие с IEC 60670-1
- без съдържание на халоген
- възможност за монтиране на монтажната рамка с винтове с Ø 3 mm

ROUND BOX BRICK SM60-01

- Ø60, depth 40mm
- 650°C, 500V~
- in accordance with IEC 60670-1
- halogen free
- option of mounting the mounting frame with Ø 3 mm screws

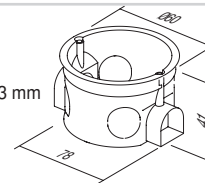

КРЪГЛИ ДЪЛБОКИ КОНЗОЛИ ЗА ТУХЛЕНИ СТЕНИ SM60-06



DE11

- Ø60, дълбочина 60 mm
- 650° C, 500 V~
- в съответствие с IEC 60670-1
- без съдържание на халоген
- възможност за монтиране на монтажната рамка с винтове с Ø 3 mm

ROUND BOX BRICK DEEP SM60-06

- Ø60, depth 60mm
- 650°C, 500V~
- in accordance with IEC 60670-1
- halogen free
- option of mounting the mounting frame with Ø 3 mm screws

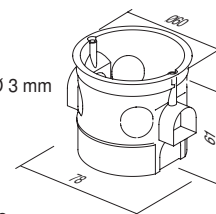

COMBI-CLIP SM60-03



DE30

- за вертикално закрепване на SM60-06 или SM60-01 на разстояние 91 mm
- в съответствие с IEC 60670-1
- без съдържание на халоген

COMBI-CLIP SM60-03

- for vertical fitting of boxes SM60-06 or SM60-01 on distance 91 mm
- in accordance with IEC 60670-1
- halogen free

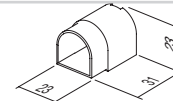

COMBI-CLIP SM60-04

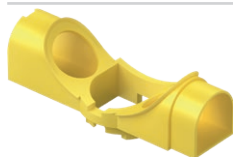

DE31







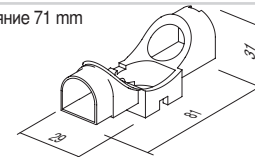



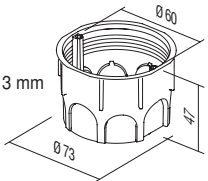

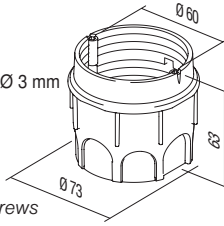

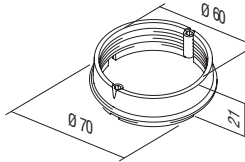
- за хоризонтално закрепване на SM60-06 или SM60-01 на разстояние 71 mm
- в съответствие с IEC 60670-1
- без съдържание на халоген

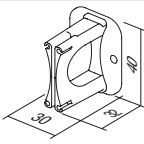
COMBI-CLIP SM60-04

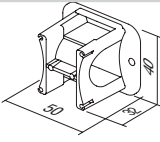
- for horizontal fitting of boxes SM60-06 or SM60-01 on distance 71mm
- in accordance with IEC 60670-1
- halogen free

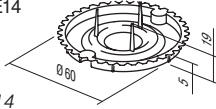

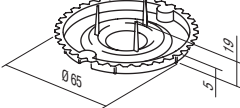
R O U N D B O X E S

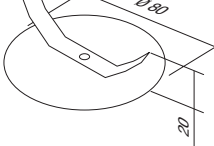
	DE12	КРЪГЛИ КОНЗОЛИ ЗА ТУХЛЕНИ СТЕНИ MD65-46	<ul style="list-style-type: none"> - Ø65, дълбочина 46 mm - 650° C, 500 V~ - в съответствие с IEC 60670-1 - без съдържание на халоген - възможност за монтиране на монтажната рамка с винтове с Ø 3 mm 	
		ROUND BOX BRICK MD65-46	<ul style="list-style-type: none"> - Ø65, depth 46mm - 650° C, 500V~ - in accordance with IEC 60670-1 - halogen free - option of mounting the mounting frame with Ø 3 mm screws 	
	DE13	КРЪГЛИ ДЪЛБОКИ КОНЗОЛИ ЗА ТУХЛЕНИ СТЕНИ MD65-60	<ul style="list-style-type: none"> - Ø65/60, дълбочина 62 mm - 650° C, 500 V~ - в съответствие с IEC 60670-1 - без съдържание на халоген - възможност за монтиране на монтажната рамка с винтове с Ø 3 mm 	
		ROUND BOX BRICK DEEP MD65-60	<ul style="list-style-type: none"> - Ø65/60, depth 62mm - 650° C, 500V~ - in accordance with IEC 60670-1 - halogen free - option of mounting the mounting frame with Ø 3 mm screws 	
	DE14	ДОПЪЛНИТЕЛЕН ДЕТАЙЛ ЗА MD65-46	<ul style="list-style-type: none"> - Ø65/60, дълбочина 17mm - 650° C, 500 V~ - в съответствие с IEC 60670-1 - без съдържание на халоген 	
		ADDITIONAL PIECE FOR MD65-46	<ul style="list-style-type: none"> - Ø65/60, depth 17mm - 650° C, 500V~ - in accordance with IEC 60670-1 - halogen free 	
	DE32	COMBI-CLIP MD65-71	<ul style="list-style-type: none"> - за закрепване на конзоли MD65 на разстояние 71 mm - в съответствие с IEC 60670-1 - без съдържание на халоген 	
		COMBI-CLIP MD65-71	<ul style="list-style-type: none"> - for fitting of boxes MD65 on distance 71mm - in accordance with IEC 60670-1 - halogen free 	
	DE33	COMBI-CLIP MD65-91	<ul style="list-style-type: none"> - за закрепване на конзоли MD65 на разстояние 91 mm - в съответствие с IEC 60670-1 - без съдържание на халоген 	
		COMBI-CLIP MD65-91	<ul style="list-style-type: none"> - for fitting of boxes MD65 on distance 91mm - in accordance with IEC 60670-1 - halogen free 	
	DE20	BOX COVER PROTECTIVE 60	<ul style="list-style-type: none"> - защитно капаче за конзола за конзола Ø60 DE10, DE11, DE13, DE14 - в съответствие с IEC 60670-1 - за защитаване на конзолата по време на измазване 	
		BOX COVER PROTECTIVE 60	<ul style="list-style-type: none"> - protective cover for box Ø60 for DE10, DE11, DE13, DE14 - in accordance with IEC 60670-1 - box protection during plastering 	
	DE21	BOX COVER PROTECTIVE 65	<ul style="list-style-type: none"> - защитно капаче за конзола за конзола Ø65 DE12 - в съответствие с IEC 60670-1 - за защитаване на конзолата по време на измазване 	
		BOX COVER PROTECTIVE 65	<ul style="list-style-type: none"> - protective cover for box Ø65 for DE12 - in accordance with IEC 60670-1 - box protection during plastering 	
	DE22	BOX COVER SM60	<ul style="list-style-type: none"> - декоративно капаче за конзоли Ø60 - в съответствие с IEC 60670-1 - без съдържание на халоген 	
		BOX COVER DECORATIVE SM60	<ul style="list-style-type: none"> - decorative cover for boxes Ø60 - in accordance with IEC 60670-1 - halogen free 	



указания за сглобяване /
assembly instructions

DE10,11

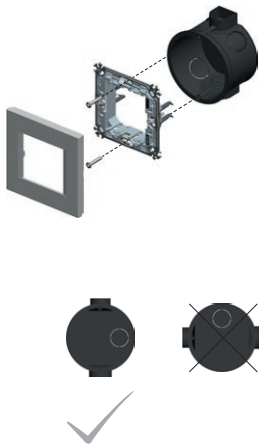

разстояние между конзолите /
distance between boxes: 71 mm

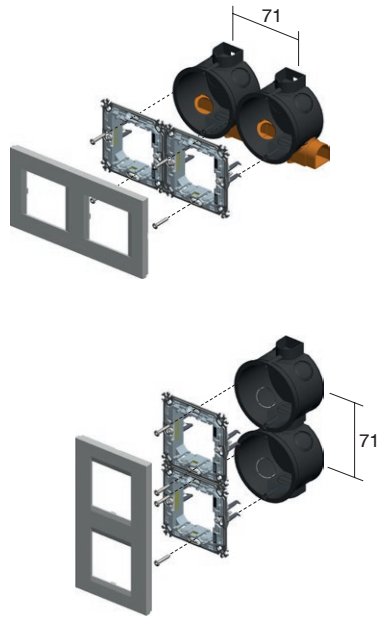

разстояние между конзолите /
distance between boxes: 91 mm

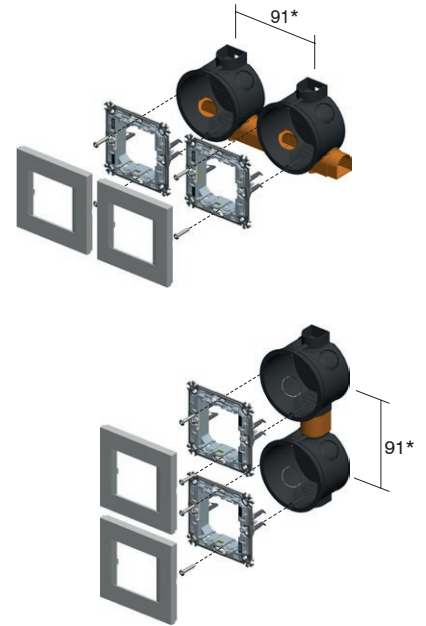

DE12,13

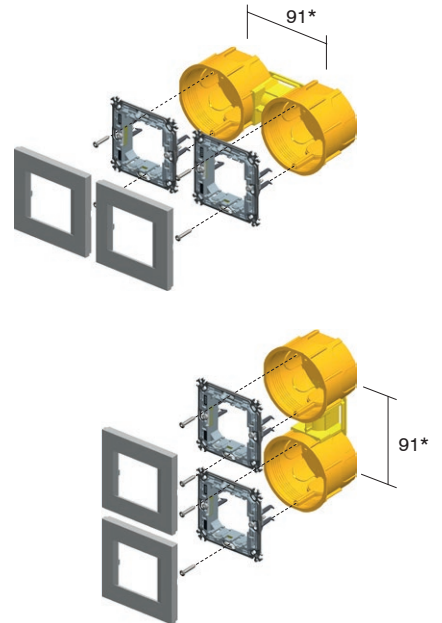
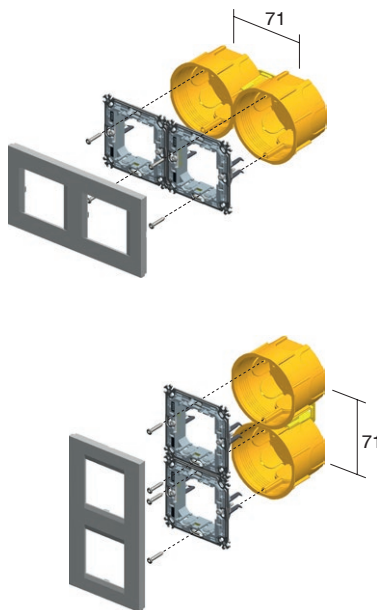
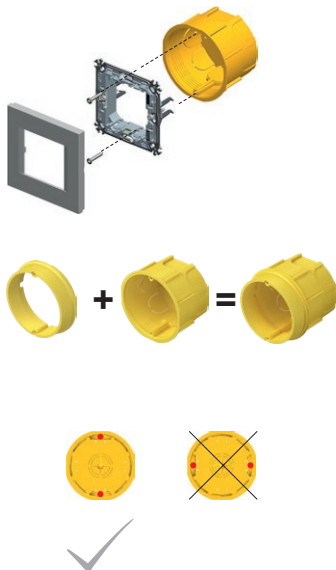

* за панели PURE минималното разстояние между конзолите е 100 mm
* for PURE cover plates the minimum distance between boxes is 100mm

R O U N D B O X E S



DE10,11



DE12,13



NM20



NM24



DE10,11



DE12,13



NM10



DE10,11



DE12,13



NM23



71

2xDE10,11 + 2xDE31



2xNM20



2xDE12,13 + 1xDE32



2xNM24



2xDE10,11 2xDE12,13 + 1xDE32



2xNM20



2xNM24



3xDE10,11 + 3xDE31



3xNM20



3xDE12,13 + 2xDE32



3xNM24

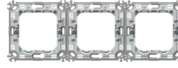

3xDE10,11 3xDE12,13 + 2xDE32



3xNM20



3xNM24



4xDE10,11 + 4xDE31



4xNM20



4xDE12,13 + 3xDE32



4xNM24



4xDE10,11 4xDE12,13 + 3xDE32

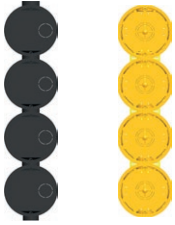

4xNM20



4xNM24



5xDE10,11

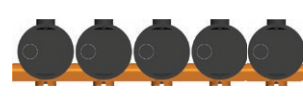

5xNM20



5xDE12,13 + 4xDE32



5xNM24



КРЪГЛА КОНЗОЛА ЗА КУХИ СТЕНИ SM68x40



HE10

- Ø60, дълбочина 40 mm
- прорязване на отвор Ø68
- 850° C, 400 V~
- в съответствие с IEC 60670-1
- монтаж с крачета
- без съдържание на халоген
- монтиране на монтажната рамка с винтове с Ø 3 mm

ROUND BOX HOLLOW WALL SM68x40

- Ø60, depth 40mm
- cutting hole Ø68
- 850°C, 400V~
- in accordance with IEC 60670-1
- mounting with claws
- halogen free
- mounting the mounting frame with Ø 3 mm screws

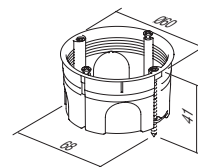

КРЪГЛА КОНЗОЛА ЗА КУХИ СТЕНИ SM68x55



HE11

- Ø60, дълбочина 55 mm
- прорязване на отвор Ø68
- 850° C, 400 V~
- в съответствие с IEC 60670-1
- монтаж с крачета
- без съдържание на халоген
- монтиране на монтажната рамка с винтове с Ø 3 mm

ROUND BOX HOLLOW WALL SM68x55

- Ø60, depth 55mm
- cutting hole Ø68
- 850°C, 400V~
- in accordance with IEC 60670-1
- mounting with claws
- halogen free
- mounting the mounting frame with Ø 3 mm screws

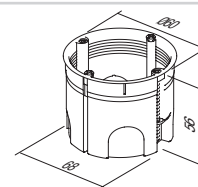

КРЪГЛИ КОНЗОЛИ ЗА СТЕНИ ОТ БЕТОН



BE10

- Ø60 mm, дълбочина 49 mm
- 650° C, 500 V~
- в съответствие с IEC 60670-1
- без съдържание на халоген
- монтиране на монтажната рамка с винтове с Ø 3 mm

ROUND BOX CONCRETE

- Ø60mm, depth 49mm
- 650°C, 500V~
- in accordance with IEC 60670-1
- halogen free
- mounting the mounting frame with Ø 3 mm screws

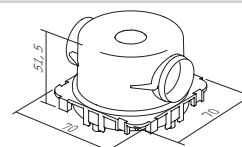

КРЪГЛИ ДЪЛБОКИ КОНЗОЛИ ЗА СТЕНИ ОТ БЕТОН



BE11

- Ø60 mm, дълбочина 58mm
- 650° C, 500 V~
- в съответствие с IEC 60670-1
- без съдържание на халоген
- монтиране на монтажната рамка с винтове с Ø 3 mm

ROUND BOX CONCRETE DEEP

- Ø60mm, depth 58mm
- 650°C, 500V~
- in accordance with IEC 60670-1
- halogen free
- mounting the mounting frame with Ø 3 mm screws

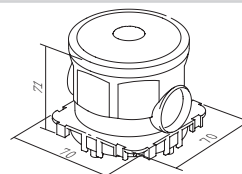

ЗАДНА ОПОРА ЗА КОНЗОЛА ЗА СТЕНИ ОТ БЕТОН



BE20

- за поддържане на конзоли за бетон с дистанционен профил BM82 срещу стената
- в съответствие с IEC 60670-1
- без съдържание на халоген

COUNTER BOX SUPPORT CONCRETE

- to support concrete boxes with discance profile BM82 for extreme loads
- in accordance with IEC 60670-1
- halogen free

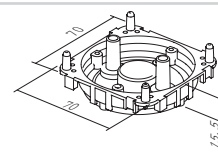

PIPE STOPPER CONCRETE BOX 16



BE21

- за закрепване на инсталационна тръба към конзола
- в съответствие с IEC 60670-1
- без съдържание на халоген

PIPE STOPPER CONCRETE BOX 16

- for firming installation pipe to box
- in accordance with IEC 60670-1
- halogen free

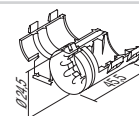

R O U N D B O X E S

кухи стени / hollow walls



бетон / concrete



указания за сглобяване /
assembly instructions

разстояние между конзолите /
distance between boxes: 71 mm

разстояние между конзолите /
distance between boxes: 91 mm

HE10,11

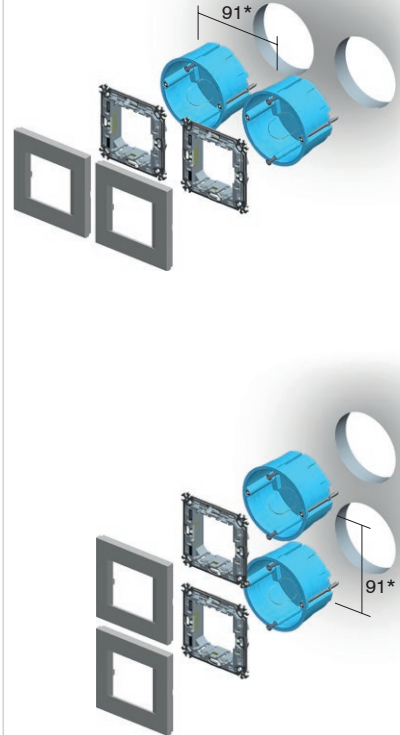
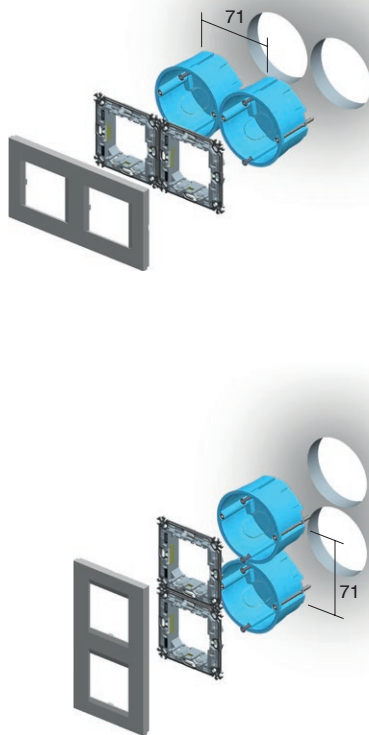
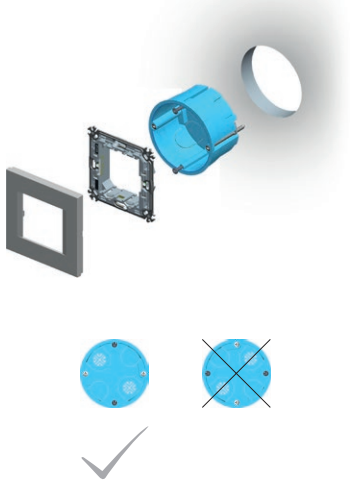

BE10

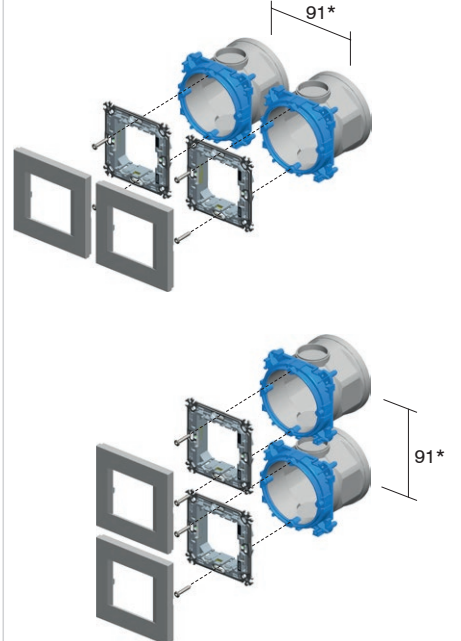
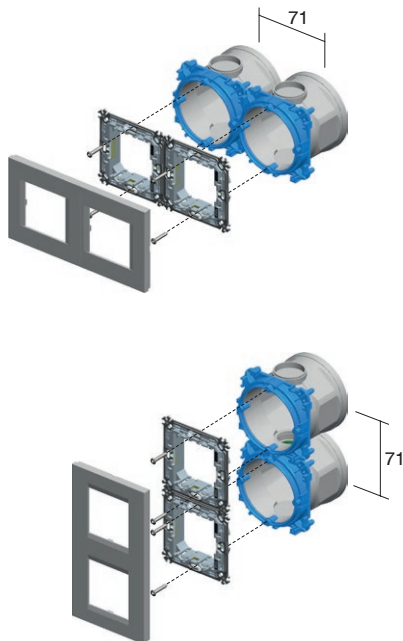
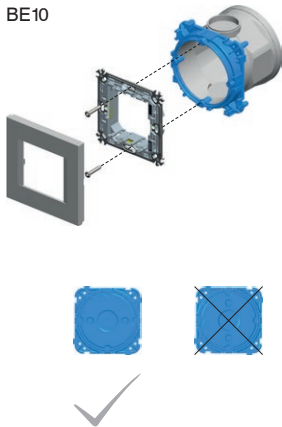

* за панелите PURE минималното разстояние между конзолите е 100 mm
* for PURE cover plates the minimum distance between boxes is 100mm

К Р Ъ Г Л И К О Н З О Л И

кухи стени/ hollow walls



бетон/ concrete

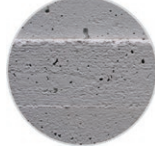

HE10,11



BE10,11



NM21



NM25



2M

HE10,11



BE10,11



NM11



1/2M

2xHE10,11



2xBE10,11



2xNM21



2xNM25



2x2M

HE10,11



BE10,11



NM32



2/3M

2xHE10,11



2xBE10,11



2xNM21



2xNM25



5xHE10,11



5xNM21



5xBE10,11



5xNM25



5x2M

3xHE10,11

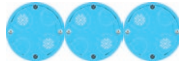

3xBE10,11



3xNM21



3xNM25



3x2M

3xHE10,11



3xBE10,11



3xNM21



3xNM25



4xHE10,11



4xBE10,11



4xNM21



4xNM25



4x2M

4xHE10,11



4xBE10,11



4xNM21



4xNM25



R O U N D B O X E S

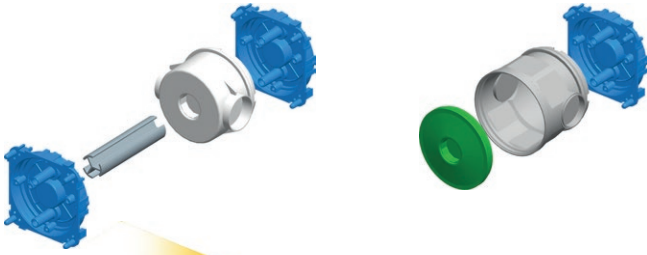

указания за сглобяване /
assembly instructions

1

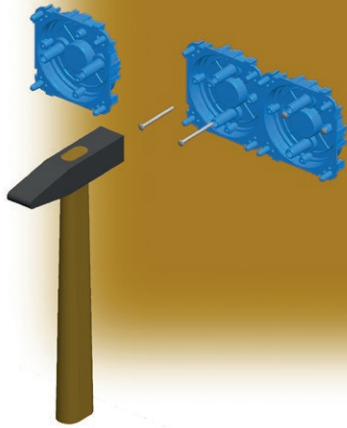

2

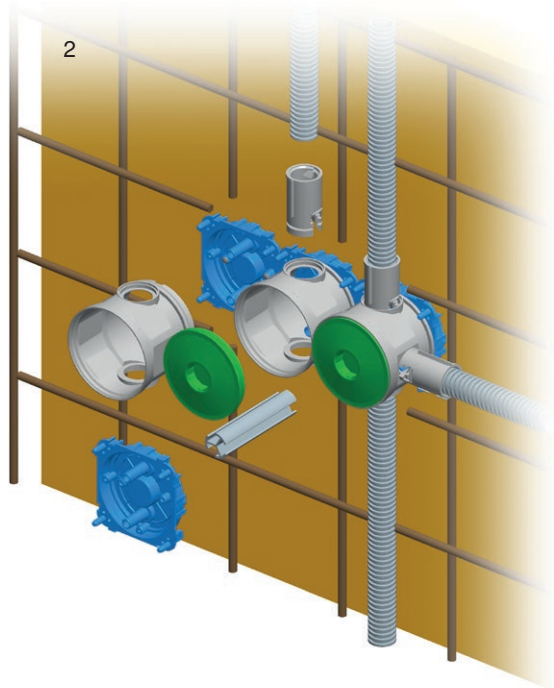

3

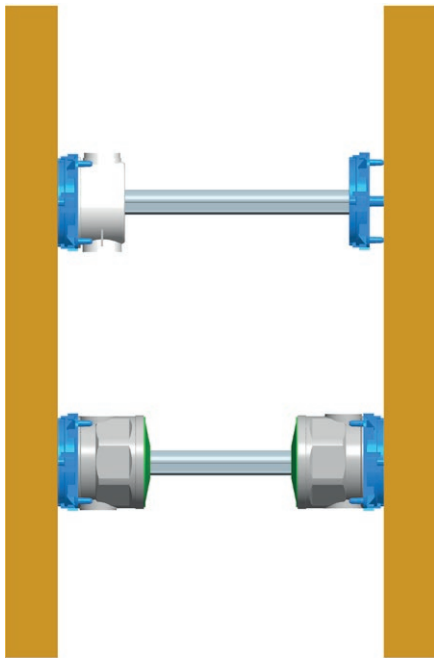

4

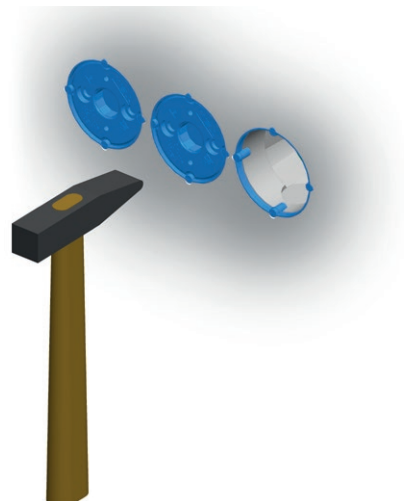

П Р А В О Ъ Г Ъ Л Н И К О Н З О Л И



DM30



HM30



BM30

тип type	описание description	размер size
DM30	ПРАВОЪГЪЛНА КОНЗОЛА ЗА ТУХЛЕНИ СТЕНИ <i>RECTANGULAR BOX BRICK</i>	PM3
HM30	ПРАВОЪГЪЛНА КОНЗОЛА ЗА КУХИ СТЕНИ <i>RECTANGULAR BOX HOLLOW WALL</i>	VM3
BM30	ПРАВОЪГЪЛНА КОНЗОЛА ЗА СТЕНИ ОТ БЕТОН <i>RECTANGULAR BOX CONCRETE</i>	BM3
...

ПРАВОЪГЪЛНА КОНЗОЛА ЗА ТУХЛЕНИ СТЕНИ PM3



DM30

- размер 3М, дълбочина 49 mm
- 650° C, 400V~
- в съответствие с IEC 60670-1
- без съдържание на халоген

RECTANGULAR BOX BRICK PM3

- size 3M, depth 49mm
- 650°C, 400V~
- in accordance with IEC 60670-1
- halogen free

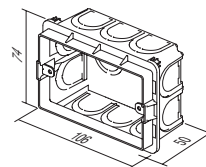

ПРАВОЪГЪЛНА КОНЗОЛА ЗА ТУХЛЕНИ СТЕНИ PM3-65



DM31

- размер 3М, дълбочина 65mm
- 650° C, 400V~
- в съответствие с IEC 60670-1
- без съдържание на халоген

RECTANGULAR BOX BRICK PM3-65

- size 3M, depth 65mm
- 650°C, 400V~
- in accordance with IEC 60670-1
- halogen free

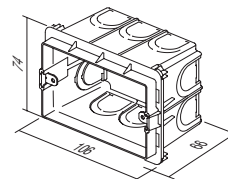

ПРАВОЪГЪЛНА КОНЗОЛА ЗА ТУХЛЕНИ СТЕНИ PM4



DM40

- размер 4М, дълбочина 49 mm
- 650° C, 400V~
- в съответствие с IEC 60670-1
- без съдържание на халоген

RECTANGULAR BOX BRICK PM4

- size 4M, depth 49mm
- 650°C, 400V~
- in accordance with IEC 60670-1
- halogen free

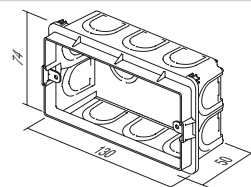

ПРАВОЪГЪЛНА КОНЗОЛА ЗА ТУХЛЕНИ СТЕНИ PM4-65



DM41

- размер 4М, дълбочина 65mm
- 650° C, 400V~
- в съответствие с IEC 60670-1
- без съдържание на халоген

RECTANGULAR BOX BRICK PM4-65

- size 4M, depth 65mm
- 650°C, 400V~
- in accordance with IEC 60670-1
- halogen free

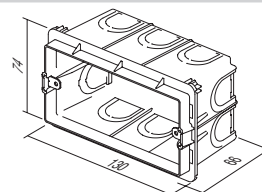

R E C T A N G U L A R B O X E S

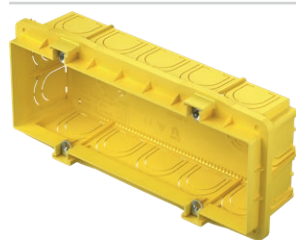

DM70

ПРАВОЪГЪЛНА КОНЗОЛА ЗА ТУХЛЕНИ СТЕНИ PM7

- размер 7М, дълбочина 49 mm
- 650° C, 400V~
- в съответствие с IEC 60670-1
- без съдържание на халоген

RECTANGULAR BOX BRICK PM7

- size 7M, depth 49mm
- 650°C, 400V~
- in accordance with IEC 60670-1
- halogen free

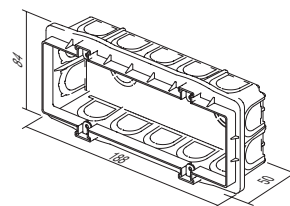

DM71

ПРАВОЪГЪЛНА КОНЗОЛА ЗА ТУХЛЕНИ СТЕНИ PM7-65

- размер 7М, дълбочина 65mm
- 650° C, 400V~
- в съответствие с IEC 60670-1
- без съдържание на халоген

RECTANGULAR BOX BRICK PM7-65

- size 7M, depth 65mm
- 650°C, 400V~
- in accordance with IEC 60670-1
- halogen free

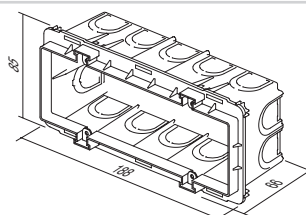

DM72

ПРАВОЪГЪЛНА КОНЗОЛА ЗА ТУХЛЕНИ СТЕНИ PM72-65

- размер 2x7М, дълбочина 64mm
- 650° C, 400V~
- в съответствие с IEC 60670-1
- без съдържание на халоген

RECTANGULAR BOX BRICK PM72-65

- size 2x7M, depth 64mm
- 650°C, 400V~
- in accordance with IEC 60670-1
- halogen free

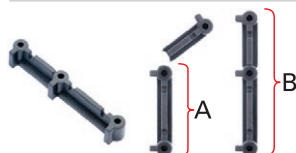
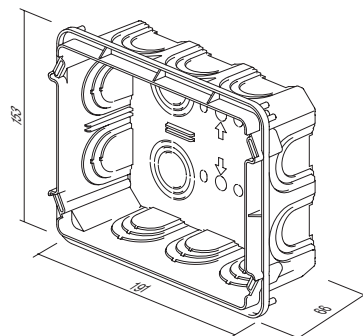

DM80

ДИСТАНЦИОНЕН ЕЛЕМЕНТ ЗА КОНЗОЛА PM

- за вертикален (A) и хоризонтален (B) монтаж на конзоли PM3, PM4 в PM7
- подходящ за декоративни панели LINE and SOFT (не за PURE)

DISTANCE PIECE FOR BOX PM

- for vertical (A) and horizontal (B) fitting of boxes PM3, PM4 and PM7
- suitable for Line and Soft decorative cover plates (not for PURE)

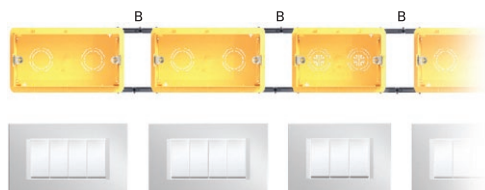
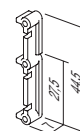

П Р А В О Ъ Г Ъ Л Н И К О Н З О Л И



DM33

BOX COVER PROTECTIVE PM3

- защитно капаче за конзола PM3
- в съответствие с IEC 60670-1
- без съдържание на халоген
- за защита на конзолата по време на измазване

BOX COVER PROTECTIVE PM3

- protective cover for box PM3
- in accordance with IEC 60670-1
- halogen free
- box protection during plastering

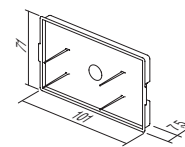

DM34

BOX COVER DECORATIVE PM3

- декоративно капаче за конзоли 3M
- винтовете са включени в доставката
- в съответствие с IEC 60670-1
- без съдържание на халоген

BOX COVER DECORATIVE PM3

- decorative cover for boxes 3M
- screws are included
- in accordance with IEC 60670-1
- halogen free

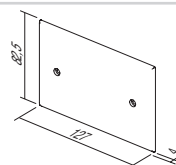

DM43

BOX COVER PROTECTIVE PM4

- защитно капаче за конзола PM4
- в съответствие с IEC 60670-1
- без съдържание на халоген
- за защита на конзолата по време на измазване

BOX COVER PROTECTIVE PM4

- protective cover for box PM4
- in accordance with IEC 60670-1
- halogen free
- box protection during plastering

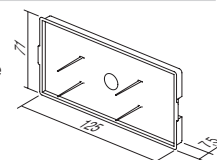

DM44

BOX COVER DECORATIVE PM4

- декоративно капаче за конзоли 4M
- винтовете са включени в доставката
- в съответствие с IEC 60670-1
- без съдържание на халоген

BOX COVER DECORATIVE PM4

- decorative cover for boxes 4M
- screws are included
- in accordance with IEC 60670-1
- halogen free

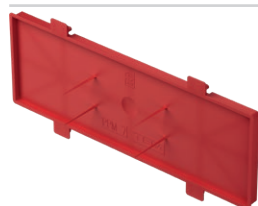
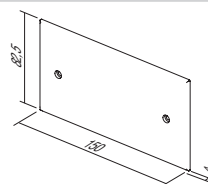

DM73

BOX COVER PROTECTIVE PM7

- защитно капаче за конзола PM7
- в съответствие с IEC 60670-1
- без съдържание на халоген
- за защита на конзолата по време на измазване

BOX COVER PROTECTIVE PM7

- protective cover for box PM7
- in accordance with IEC 60670-1
- halogen free
- box protection during plastering

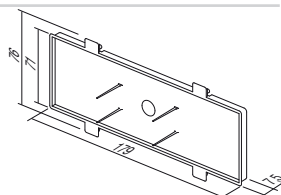

DM74

BOX COVER DECORATIVE PM7

- декоративно капаче за конзоли 7M
- винтовете са включени в доставката
- в съответствие с IEC 60670-1
- без съдържание на халоген

BOX COVER DECORATIVE PM7

- decorative cover for boxes 7M
- screws are included
- in accordance with IEC 60670-1
- halogen free

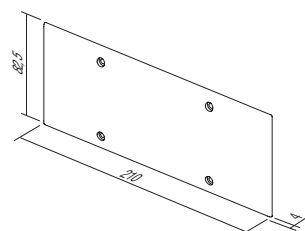

R E C T A N G U L A R B O X E S



DM75

BOX COVER DECORATIVE PM72

- декоративно капаче за конзоли 2x7M
- винтовете са включени в доставката
- в съответствие с IEC 60670-1

BOX COVER DECORATIVE PM72

- decorative cover for boxes 2x7M
- screws are included
- in accordance with IEC 60670-1

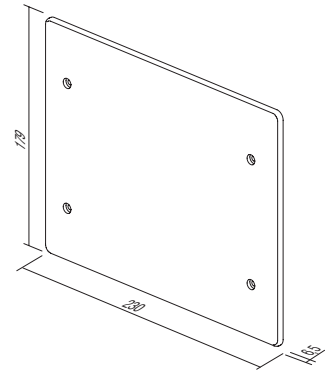

ПРАВЪЪГЪЛНА КОНЗОЛА ЗА КУХИ СТЕНИ VM3



HM30

- размер 3M, дълбочина 49 mm
- прорязване на отвор 2xØ68/45 mm
- 850° C, 400 V~
- в съответствие с IEC 60670-1
- без съдържание на халоген

RECTANGULAR BOX HOLLOW WALL VM3

- size 3M, depth 49mm
- cutting hole 2xØ68/45mm
- 850°C, 400V~
- in accordance with IEC 60670-1
- halogen free

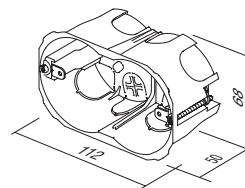

ПРАВЪЪГЪЛНА КОНЗОЛА ЗА КУХИ СТЕНИ VM4



HM40

- размер 4M, дълбочина 49 mm
- прорязване на отвор 2xØ68/70 mm
- 850° C, 400 V~
- в съответствие с IEC 60670-1
- без съдържание на халоген

RECTANGULAR BOX HOLLOW WALL VM4

- size 4M, depth 49mm
- cutting hole 2xØ68/70mm
- 850°C, 400V~
- in accordance with IEC 60670-1
- halogen free

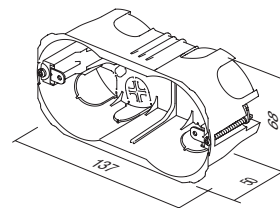

ПРАВЪЪГЪЛНА КОНЗОЛА ЗА КУХИ СТЕНИ VM7



HM70

- размер 7M, дълбочина 49 mm
- прорязване на отвор 2xØ68/120 mm
- 850° C, 400 V~
- в съответствие с IEC 60670-1
- без съдържание на халоген

RECTANGULAR BOX HOLLOW WALL VM7

- size 7M, depth 49mm
- cutting hole 2xØ68/120mm
- 850°C, 400V~
- in accordance with IEC 60670-1
- halogen free

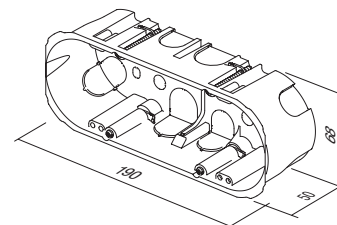

ПРАВЪЪГЪЛНА КОНЗОЛА ЗА КУХИ СТЕНИ VM72



HM72

- размер 2x7M, дълбочина 63mm
- 850° C, 400 V~
- в съответствие с IEC 60670-1
- без съдържание на халоген

RECTANGULAR BOX HOLLOW WALL VM72

- size 2x7M, depth 63mm
- 850°C, 400V~
- in accordance with IEC 60670-1
- halogen free

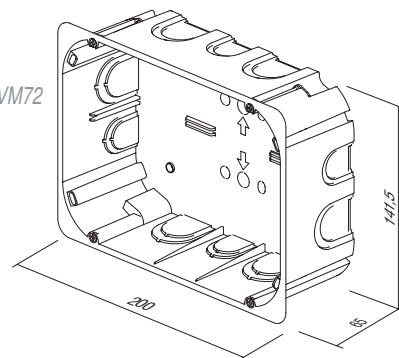

R E C T A N G U L A R B O X E S

ПРАВОЪГЪЛНА КОНЗОЛА ЗА СЕНИ ОТ БЕТОН ВМ3



ВМ30

- размер 3М, дълбочина 60 mm
- 650° C, 400V~
- в съответствие с IEC 60670-1
- без съдържание на халоген

RECTANGULAR BOX CONCRETE BM3

- size 3M, depth 60mm
- 650°C, 400V~
- in accordance with IEC 60670-1
- halogen free

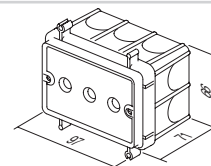

ПРАВОЪГЪЛНА КОНЗОЛА ЗА СЕНИ ОТ БЕТОН ВМ4



ВМ40

- размер 4М, дълбочина 60 mm
- 650° C, 400V~
- в съответствие с IEC 60670-1
- без съдържание на халоген

RECTANGULAR BOX CONCRETE BM4

- size 4M, depth 60mm
- 650°C, 400V~
- in accordance with IEC 60670-1
- halogen free

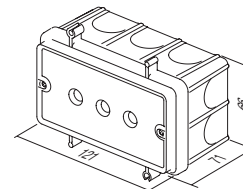

ПРАВОЪГЪЛНА КОНЗОЛА ЗА СЕНИ ОТ БЕТОН ВМ7



ВМ70

- размер 7М, дълбочина 60 mm
- 650° C, 400V~
- в съответствие с IEC 60670-1
- без съдържание на халоген

RECTANGULAR BOX CONCRETE BM7

- size 7M, depth 60mm
- 650°C, 400V~
- in accordance with IEC 60670-1
- halogen free

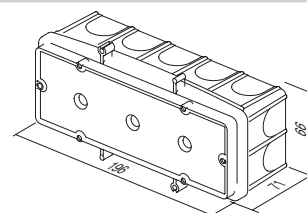

FIXING COMBI-CLIP ВМ



ВМ80

- за бързо закрепване правоъгълни конзоли ВМ върху подсилваща шина
- подходящо за пръти с диаметър до Ø8 mm

FIXING COMBI-CLIP ВМ

- for fast fixation of ВМ rectangular boxes on reinforcing bar
- suitable for bar diameter up to Ø8mm

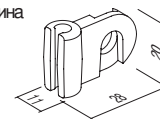

ДИСТАНЦИОНЕН ПРОФИЛ ЗА КОНЗОЛИ ВМ



ВМ82

- за поддържане на конзоли ВМ с опора върху стената
- дължина l=1 m, диаметър Ø20 mm

DISTANCE PROFIL FOR BOXES ВМ

- to support boxes ВМ with counter box support on opposite wall
- length l=1m, diameter Ø20mm

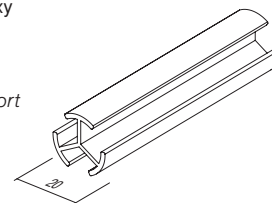

П Р А В О Ъ Г Ъ Л Н И К О Н З О Л И



тухла/ brick



кухи стени/ hollow walls

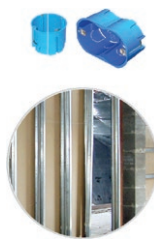

бетон/ concrete



DM30		NM30 	3M
HM30			
BM30			
DM40		NM40 	4M
HM40			
BM40			
DM70		NM70 	7M
HM70			
BM70			
DM72		NM72 	2x7M
HM72			
DM30		NM32 	2/3M
HM30			
BM30			

R E C T A N G U L A R B O X E S

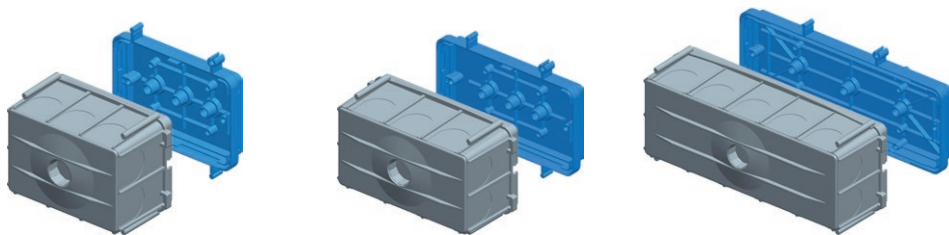

указания за сглобяване /
assembly instructions

1

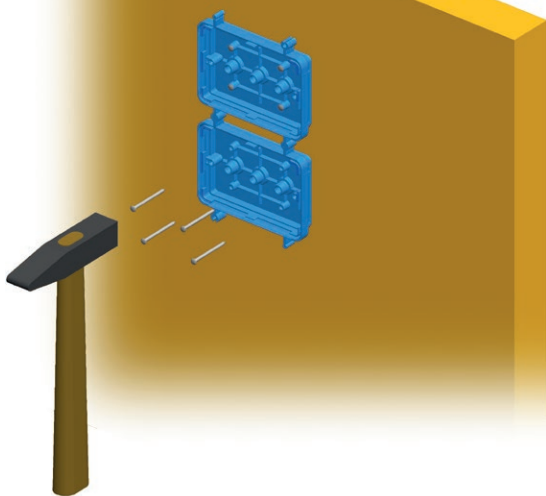

2

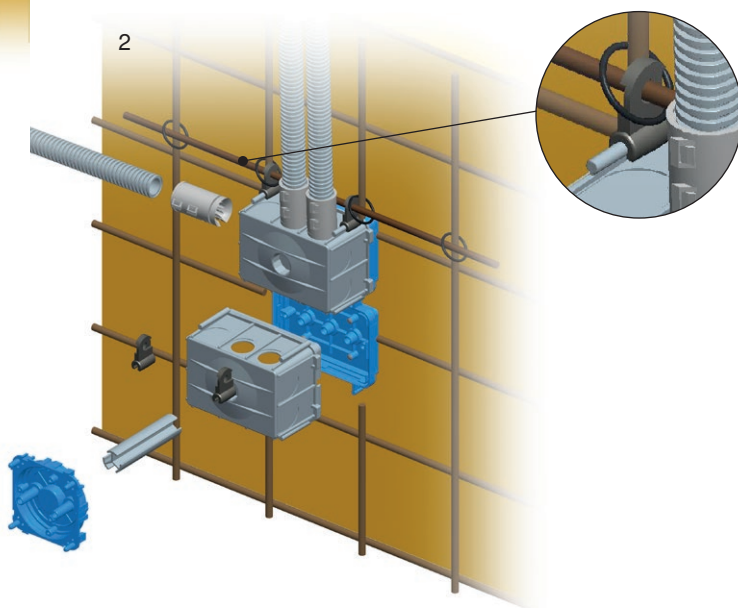

3

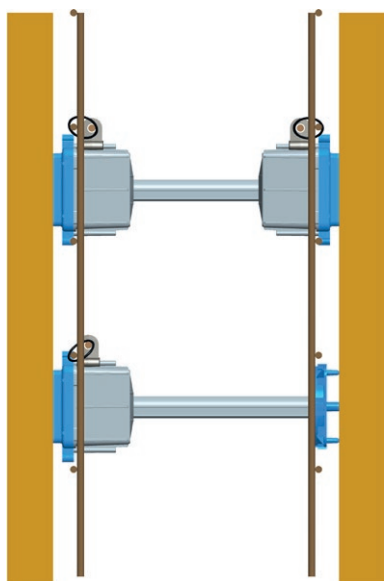

4

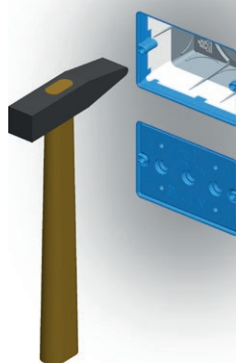

С Ъ Е Д И Н И Т Е Л Н И К У Т И И

КРЪГЛА СЪЕДИНИТЕЛНА КОНЗОЛА ЗА ТУХЛЕНИ СТЕНИ DSM78



DW10

- Ø78, дълбочина 40 mm
- 650° C, 500 V~
- в съответствие с IEC 60670-1 и IEC 60670-22
- без съдържание на халоген

CONNECTION ROUND BOX BRICK DSM78

- Ø78, depth 40mm
- 650°C, 500V~
- in accordance with IEC 60670-1 and IEC 60670-22
- halogen free

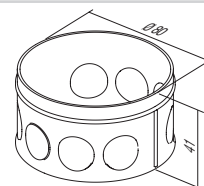

КРЪГЛА СЪЕДИНИТЕЛНА КОНЗОЛА ЗА КУХИ СТЕНИ SM78x45



HW10

- Ø78, дълбочина 45 mm
- прорязване на отвор Ø80
- 850° C, 400 V~
- в съответствие с IEC 60670-1 и IEC 60670-22
- монтаж с крачета
- без съдържание на халоген

CONNECTION ROUND BOX HOLLOW WALL SM78x45

- Ø78, depth 45mm
- cutting hole Ø80
- 850°C, 400V~
- in accordance with IEC 60670-1 and IEC 60670-22
- mounting with claws
- halogen free

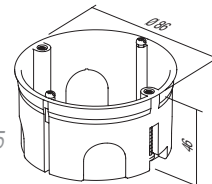

BOX COVER SM78



DE23

- декоративно капаче за конзоли Ø78
- в съответствие с IEC 60670-1 и IEC 60670-22
- без съдържание на халоген

BOX COVER DECORATIVE SM78

- decorative cover for boxes Ø78
- in accordance with IEC 60670-1 and IEC 60670-22
- halogen free

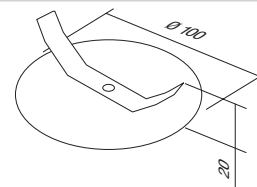

BOX COVER PROTECTIVE 78



DE24

- защитно капаче за конзола Ø78
- в съответствие с IEC 60670-1 и IEC 60670-22
- без съдържание на халоген

BOX COVER PROTECTIVE 78

- protective cover for box Ø78
- in accordance with IEC 60670-1 and IEC 60670-22
- halogen free

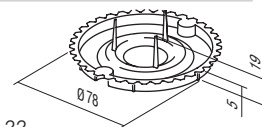

КВАДРАТНА СЪЕДИНИТЕЛНА КОНЗОЛА ЗА ТУХЛЕНИ СТЕНИ SM105x105



HW20

- размер 105x105mm, дълбочина 50 mm
- прорязване на отвор с приложения шаблон
- 850° C, 400 V~
- в съответствие с IEC 60670-1 и IEC 60670-22
- монтаж с крачета
- без съдържание на халоген

CONNECTION SQUARE BOX BRICK SM105x105

- size 105x105mm, depth 50mm
- cutting hole according to attached template
- 850°C, 400V~
- in accordance with IEC 60670-1 and IEC 60670-22
- mounting with claws
- halogen free

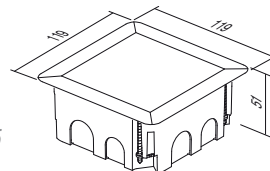

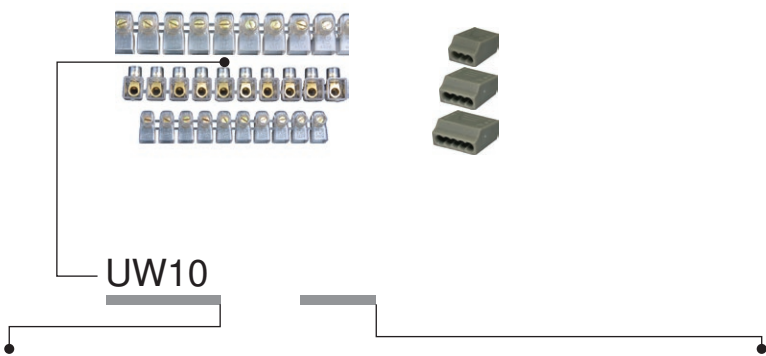

тип type	описание description	технически данни technical data	размер size	цвет colour
UW10	1 РЕД КЛЕМОРЕДИ ЗАТВОРЕНИ 1 ROW TERMINAL BLOCKS	2x2.5mm ²	10P	TS прозрачен transparent
UW11	1 РЕД КЛЕМОРЕДИ ЗАТВОРЕНИ 1 ROW TERMINAL BLOCKS	2x4mm ²	10P	CO цвет colour
UW12	1 РЕД КЛЕМОРЕДИ ЗАТВОРЕНИ 1 ROW TERMINAL BLOCKS	2x6mm ²	10P	WH бял цвет white
·	·	·	·	GY сив grey

1 РЕД КЛЕМОРЕДИ ЗАТВОРЕНИ



- 450 V~; 2x2,5 mm² ÷ 2x6 mm²
- термопласт PC, прозрачен
- брой полюси: 10

1 ROW TERMINAL BLOCKS CLOSED

- 450V~; 2x2.5mm² ÷ 2x6mm²
- thermoplast PC, transparent
- number of poles: 10

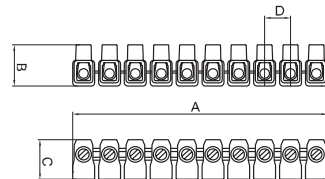

UW10TS	(NS12)	2x2.5mm ²	10P
UW11TS	(NS12)	2x4mm ²	10P
UW12TS	(NS12)	2x6mm ²	10P

	A	B	C	D
2x2.5 □	110	17.5	17.5	11
2x4 □	128	21	19	12.5
2x6 □	146	21.5	22	15

1 РЕД КЛЕМОРЕДИ

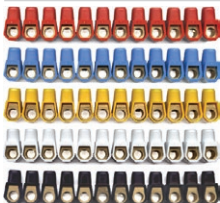

- 450 V~; 2x2,5 mm² ÷ 2x6 mm²
- термопласт PA
- предлага се в различни цветове
- брой полюси: 12

1 ROW TERMINAL BLOCKS

- 450V~; 2x2.5mm² ÷ 2x6mm²
- thermoplast PA
- available in different colours
- number of poles: 12

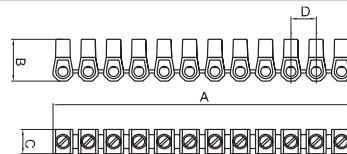

UW15CO	(NS12)	2x2.5mm ²	12P
UW16CO	(NS12)	2x4mm ²	12P
UW17CO	(NS12)	2x6mm ²	12P

	A	B	C	D
2x2.5 □	110	16.4	9	10
2x4 □	118.8	19	10	10
2x6 □	129.8	21.3	11	11.8

2 РЕДА КЛЕМОРЕДИ PP

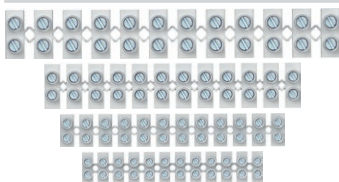

- 450 V~; 1 mm² ÷ 16 mm²
- термопласт полипропилен PP, бял
- за температури до 80° C
- брой полюси: 12

2 ROW TERMINAL BLOCKS PP

- 450V~; 1mm² ÷ 16mm²
- thermoplast polypropylene PP, white
- for temperatures up to 80° C
- number of poles: 12



					A	B	C	D	E
UW29WHPP	1.0-4.0mm ²	24 A	450 V		94,9	13	16,6	8,1	6,4
UW30WHPP	1.5-6.0mm ²	32 A	450 V		116,5	14,9	18,9	10	7,3
UW31WHPP	2.5-10mm ²	41 A	450 V		133,8	17,3	23,4	11,5	10
UW32WHPP	4-16mm ²	76 A	450 V		174,5	20,7	25	15	11

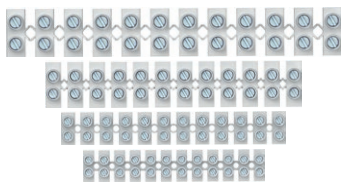

2 РЕДА КЛЕМОРЕДИ РА

- 450 V~; 1 mm² ÷ 16 mm²
- термопласт полиамид РА, бял
- за температури до 110° C
- брой полюси: 12

2 ROW TERMINAL BLOCKS PA

- 450V~; 1mm² ÷ 16mm²
- thermoplast polyamide PA, white
- for temperatures up to 110°C
- number of poles: 12

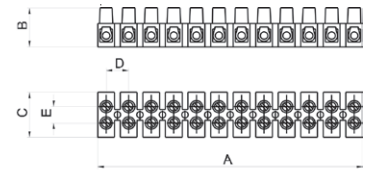

					A	B	C	D	E
UW25WHPA	1.0-4.0mm ²	24 A	450 V		93,6	13,4	16,2	8	6,4
UW26WHPA	1.5-6.0mm ²	32 A	450 V		117	15	18,6	10	7,3
UW27WHPA	2.5-10mm ²	41 A	450 V		132,8	17,3	22,2	11,5	10
UW28WHPA	4-16mm ²	76 A	450 V		173,9	20,8	25,2	15	11

СЪЕДИНИТЕЛИ С ВКАРВАНЕ НА ПРОВОДНИЦИТЕ



- 24 A 450 V~, термопласт РА, сив
- брой полюси: 3÷8
- контакти чрез вкарване 0,5÷1,5 mm², за твърди проводници
- в съответствие с EN 60998-1

PLUG-IN WIRE CONNECTORS

- 24A 450V~, thermoplast PA, grey
- number of poles: 3÷8
- plug-in contacts 0.5÷1.5mm², for rigide wires
- in accordance with EN 60998-1

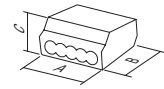

UW40GY	PC153	1.5mm ²	3P	3P	A 12	B 18	C 9
UW41GY	PC155	1.5mm ²	5P	5P	17	18	9
UW42GY	PC158	1.5mm ²	8P	8P	26	18	9

СЪЕДИНИТЕЛИ С ВКАРВАНЕ НА ПРОВОДНИЦИТЕ



- 24 A 450 V~, термопласт РА, сив
- брой полюси: 3÷5
- контакти чрез вкарване 1,5÷2,5 mm², за твърди проводници
- в съответствие с EN 60998-1

PLUG-IN WIRE CONNECTORS

- 24A 450V~, thermoplast PA, grey
- number of poles: 3÷5
- plug-in contacts 1.5÷2.5mm², for rigide wires
- in accordance with EN 60998-1

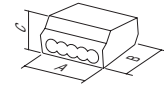

UW45GY	PC253	2.5mm ²	3P	3P	A 14	B 19	C 9
UW46GY	PC254	2.5mm ²	4P	4P	17	19	9
UW47GY	PC255	2.5mm ²	5P	5P	21	19	9

СЪЕДИНИТЕЛ С ВКАРВАНЕ НА ПРОВОДНИЦИТЕ



- 24 A 450 V~, термопласт РА, сив
- брой полюси: 2 (твърд проводник)+1 (мек проводник)
- контакти чрез вкарване 1,5÷2,5 mm²
- в съответствие с EN 60998-1

PLUG-IN WIRE CONNECTOR

- 24A 450V~, thermoplast PA, grey
- number of poles: 2 (rigide wire)+1 (soft wire)
- plug-in contacts 1.5÷2.5mm²
- in accordance with EN 60998-1

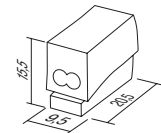

UW50WH	PC302	2.5mm ²	2/1P				
--------	-------	--------------------	------	--	--	--	--



132



133



135

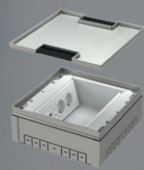

140

ДИСТРИБУЦИЯ



TEM

К О Н З О Л И С У В О I P 2 0 А С

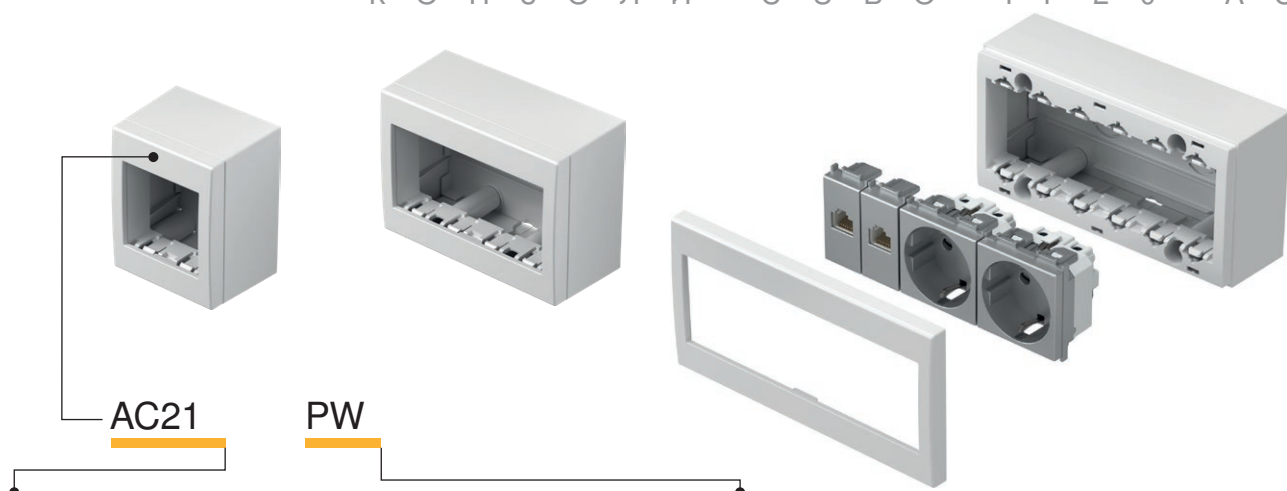

тип type	описание description	технически данни technical data	размер size	цвет colour
AC11	КОНЗОЛА NO CUBO СЪС ЗАДЕН КАПАК SURFACE MOUNT BOX WITH BACK SIDE COVER	IP20	1M	<input type="checkbox"/> PW снежнобял цвят polar white <input type="checkbox"/> ES сребрист цвят с анодизирано покритие elox silver <input type="checkbox"/> IW слонова кост ivory white
AC21	КОНЗОЛА NO CUBO СЪС ЗАДЕН КАПАК SURFACE MOUNT BOX WITH BACK SIDE COVER	IP20	2M	<input type="checkbox"/> PW снежнобял цвят polar white <input type="checkbox"/> ES сребрист цвят с анодизирано покритие elox silver <input type="checkbox"/> IW слонова кост ivory white
AC41	КОНЗОЛА NO CUBO СЪС ЗАДЕН КАПАК SURFACE MOUNT BOX WITH BACK SIDE COVER	IP20	4M	<input type="checkbox"/> PW снежнобял цвят polar white <input type="checkbox"/> ES сребрист цвят с анодизирано покритие elox silver <input type="checkbox"/> IW слонова кост ivory white

КОНЗОЛА NO CUBO СЪС ЗАДЕН КАПАК IP20 1M



- AC11PW
- AC11ES
- AC11IW

- конзола IP20 1M
- за външен монтаж на елементи
- подходяща за ключове SM
- в съответствие с EN 60669-1

BOX NO CUBO WITH BACK SIDE COVER IP20 1M
- box IP20 1M
- for surface mounting of elements
- suitable to SM switches
- in accordance with EN 60669-1



КОНЗОЛА NO CUBO СЪС ЗАДЕН КАПАК IP20 2M



- AC21PW
- AC21ES
- AC21IW

- конзола IP20 2M
- за външен монтаж на елементи
- в съответствие с EN 60669-1, EN60884-1

BOX NO CUBO WITH BACK SIDE COVER IP20 2M
- box IP20 2M
- for surface mounting of elements
- in accordance with EN 60669-1, EN60884-1



КОНЗОЛА NO CUBO СЪС ЗАДЕН КАПАК IP20 4M



- AC41PW
- AC41ES
- AC41IW

- конзола IP20 4M
- за външен монтаж на елементи
- в съответствие с EN 60669-1, EN60884-1

BOX NO CUBO WITH BACK SIDE COVER IP20 4M
- box IP20 4M
- for surface mounting of elements
- in accordance with EN 60669-1, EN60884-1



КОНЗОЛА NO CUBO СЪС ЗАДЕН КАПАК IP20 6M



- AC61PW
- AC61ES
- AC61IW

- конзола IP20 6M
- за външен монтаж на елементи
- в съответствие с EN 60669-1, EN60884-1

BOX NO CUBO WITH BACK SIDE COVER IP20 6M
- box IP20 6M
- for surface mounting of elements
- in accordance with EN 60669-1, EN60884-1



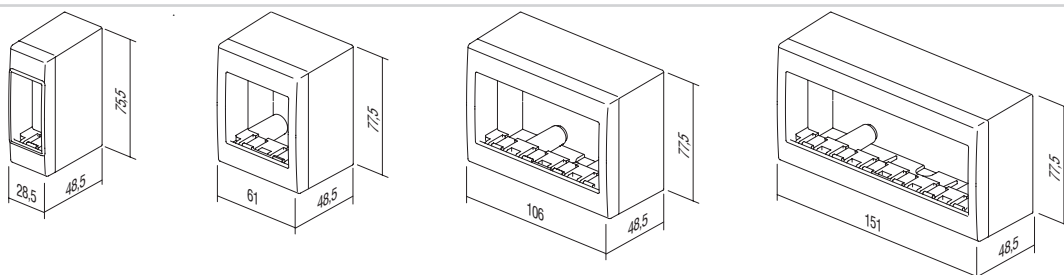

B O X E S C U B O I P 5 5 A Q



тип type	описание description	технически данни technical data	размер size	ЦВЯТ colour
AQ20	КОНЗОЛА NO CUBO OUTDOOR SURFACE MOUNT BOX	IP55	2M	<input type="checkbox"/> PW СНЕЖНОБЯЛ ЦВЯТ polar white
AQ22	КОНЗОЛА NO CUBO OUTDOOR SURFACE MOUNT BOX	IP55	2x2M	<input checked="" type="checkbox"/> GY сив grey
AQ30	КОНЗОЛА NO CUBO OUTDOOR SURFACE MOUNT BOX	IP55	3M	
AQ31	КОНЗОЛА PO CUBO OUTDOOR SURFACE MOUNT BOX	IP55	3M	

КОНЗОЛА NO CUBO IP55 2M



- AQ20PW
- AQ20GY

- конзола IP55 2M
- за външен монтаж
- IP55 за използване във влажни зони
- в съответствие с IEC 23-48, CEI 60670

BOX NO CUBO IP55 2M

- box IP55 2M
- for surface mounting
- IP55 for usage in humid areas
- in accordance with CEI 23-48, EN 60670



КОНЗОЛА NO CUBO IP55 2x2M



- AQ22PW
- AQ22GY

- конзола IP55 2x2M
- за външен монтаж
- IP55 за използване във влажни зони
- в съответствие с IEC 23-48, CEI 60670

BOX NO CUBO IP55 2x2M

- box IP55 2x2M
- for surface mounting
- IP55 for usage in humid areas
- in accordance with CEI 23-48, EN 60670



КОНЗОЛА NO CUBO IP55 3M



- AQ30PW
- AQ30GY

- конзола IP55 3M
- за външен монтаж
- IP55 за използване във влажни зони
- в съответствие с IEC 23-48, CEI 60670

BOX NO CUBO IP55 3M

- box IP55 3M
- for surface mounting
- IP55 for usage in humid areas
- in accordance with CEI 23-48, EN 60670





- AQ21PW
- AQ21AT

КУТИЯ ПО CUBO IP55 2M

- кутия IP55 2M
- може да се съчетава с функционални елементи на Modul
- за вграден монтаж
- IP55 за употреба в помещения с наличие на влага
- в съответствие със CEI 23-48, EN 60670

BOX PO CUBO IP55 2M

- box IP55 2M
- can be combined with all Modul functional elements
- for flush mounting
- IP55 for usage in humid areas
- in accordance with CEI 23-48, EN 60670



- AQ31PW
- AQ31GY

КОНЗОЛА ПО CUBO IP55 3M

- конзола IP55 3M
- за скрит монтаж
- IP55 за използване във влажни зони
- в съответствие с IEC 23-48, CEI 60670

BOX PO CUBO IP55 3M

- box IP55 3M
- for flush mounting
- IP55 for usage in humid areas
- in accordance with CEI 23-48, EN 60670

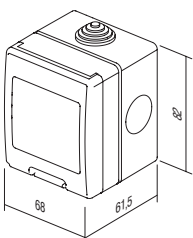

AQ20

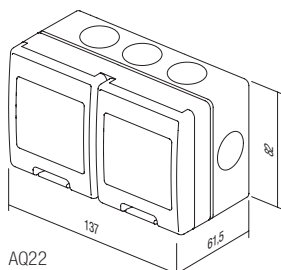

AQ22

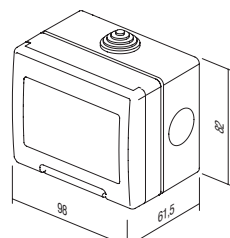

AQ30

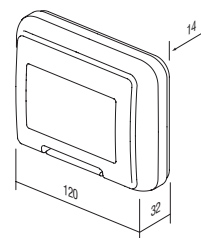

AQ31

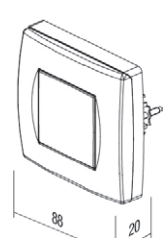

AQ21

TRUNKING SYSTEM ALUMINIUM

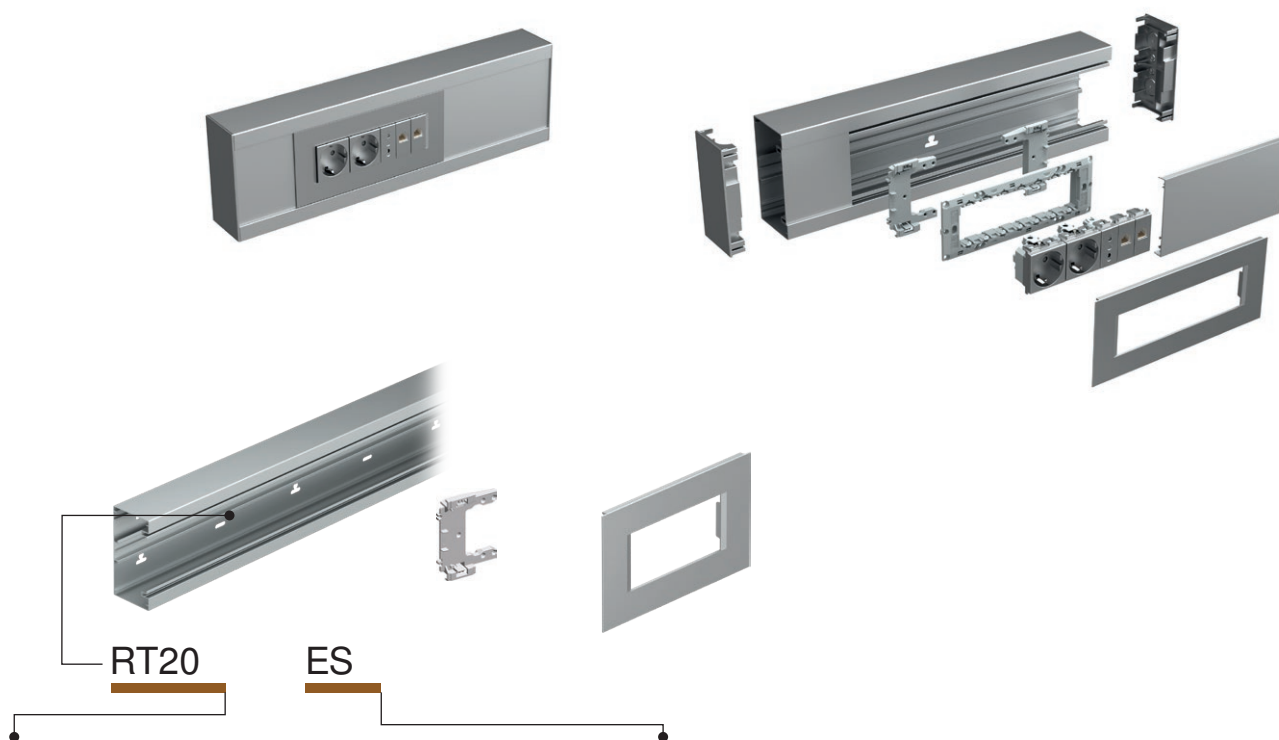

тип type	описание description	размер size	цвет colour
RT10	АДАПТЕР MA 92 ADAPTER MA 92	/	■ ES сребрист цвят с анодизирано покритие elox silver-mat
RT12	ПАНЕЛ MA 92 COVER PLATE MA 92	2/3M	□ PW бял матов (RAL 9016) white-mat
RT14	ПАНЕЛ MA 92 COVER PLATE MA 92	4M	
⋮	⋮	⋮	
⋮	⋮	⋮	

АДАПТЕР MA 92



RT10

- адаптер за закрепване за монтажни рамки 2/3M, 4M или 7M върху канал MA без конзола
- за всяка монтажна рамка са нужни два адаптера
- в съответствие с EN 50085-1

ADAPTER MA 92

- adapter for fixing mounting frames 2/3M, 4M or 7M on MA trunking without box
- each mounting frame needs two adapters
- in accordance with EN 50085-1

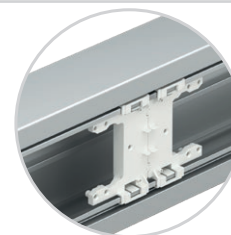

ПАНЕЛ MA 92 2/3M



■ RT12ES
□ RT12PW

- декоративен панел MA 2/3M
- в съответствие с EN 50085-1

COVER PLATE MA 92 2/3M

- decorative cover plate MA 2/3M
- in accordance with EN 50085-1

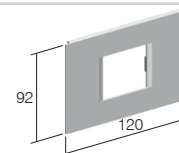

ПАНЕЛ MA 92 4M



■ RT14ES
□ RT14PW

- декоративен панел MA 4M
- в съответствие с EN 50085-1

COVER PLATE MA 92 4M

- decorative cover plate MA 4M
- in accordance with EN 50085-1

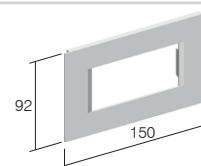

ПАНЕЛ MA 92 7M



■ RT17ES
□ RT17PW

- декоративен панел MA 7M
- в съответствие с EN 50085-1

COVER PLATE MA 92 7M

- decorative cover plate MA 7M
- in accordance with EN 50085-1

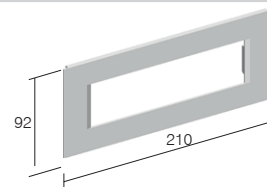

ОСНОВА ЗА КАНАЛ МА 130x65



- RT20ES
- RT20PW

- основа за канал от екструдирани алуминий
- височина 130 mm, дължина 2 m
- DIN – релса 35 mm долен профил
- в съответствие с EN 50085-1

TRUNKING BASE MA 130x65

- trunking base from extruded aluminium
- height 130mm, length 2m
- DIN - rail 35mm shape on bottom
- in accordance with EN 50085-1

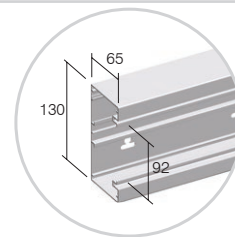

ОСНОВА ЗА КАНАЛ МА 165x65



- RT21ES
- RT21PW

- основа за канал от екструдирани алуминий
- височина 165 mm, дължина 2 m
- DIN – релса 35 mm долен профил
- в съответствие с EN 50085-1

TRUNKING BASE MA 165x65

- trunking base from extruded aluminium
- height 165mm, length 2m
- DIN - rail 35mm shape on bottom
- in accordance with EN 50085-1

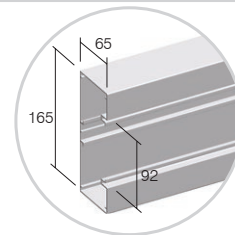

ПРЕДЕН КАПАК МА 92



- RT25ES
- RT25PW

- преден капак от екструдирани алуминий
- височина 92mm, дължина 2 m
- в съответствие с EN 50085-1

FRONT COVER MA 92

- front cover from extruded aluminium
- height 92mm, length 2m
- in accordance with EN 50085-1

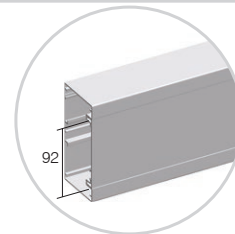

КАБЕЛНА СКАРА МА 43



RT30

- кабелна скара от екструдирани полимер
- дълбочина 43 mm, дължина 2 m
- в съответствие с EN 50085-1

CABLE SHELF MA 43

- cable shelf from extruded polymer
- depth 43mm, length 2m
- in accordance with EN 50085-1

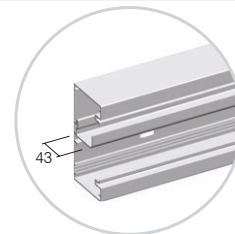

КАБЕЛНА СКАРА МА 43 AL



RT31

- кабелна скара от екструдирани алуминий
- дълбочина 43 mm, дължина 2 m
- в съответствие с EN 50085-1

CABLE SHELF MA 43 AL

- cable shelf from extruded aluminium
- depth 43mm, length 2m
- in accordance with EN 50085-1

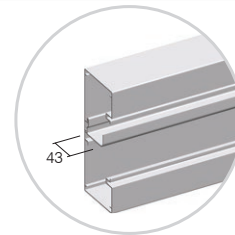

ДВОЙНА КАБЕЛНА СКАРА МА 43 AL



RT32

- двойна кабелна скара от екструдирани алуминий
- дълбочина 43 mm, дължина 2 m
- в съответствие с EN 50085-1

CABLE SHELF MA 43 AL DOUBLE

- double cable shelf from extruded aluminium
- depth 43mm, length 2m
- in accordance with EN 50085-1

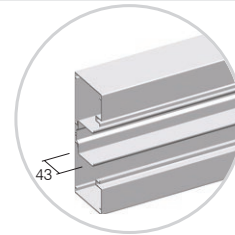

TRUNKING SYSTEM ALUMINIUM

КРАЕН ЕЛЕМЕНТ МА 130x65



- RT35ES
- RT35PW

- краен елемент от полимер
- височина 130 mm
- в съответствие с EN 50085-1

STOP END MA 130x65

- stop end element from polymer
- height 130mm
- in accordance with EN 50085-1

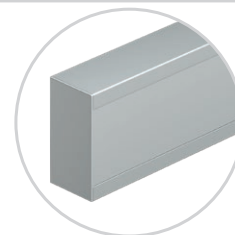

КРАЕН ЕЛЕМЕНТ МА 165x65



- RT36ES
- RT36PW

- метален краен елемент
- височина 165mm
- в съответствие с EN 50085-1

STOP END MA 165x65

- stop end element from metal
- height 165mm
- in accordance with EN 50085-1

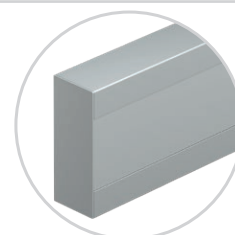

КОМПЛЕКТ СЪЕДИНИТЕЛЕН ЕЛЕМЕНТ МА 65



RT38

- съединителен елемент от полимер
- комплектът съдържа два елемента и винтове
- в съответствие с EN 50085-1

SET JOINING PIECE MA 65

- joining piece from polymer
- set contains two pieces and screws
- in accordance with EN 50085-1

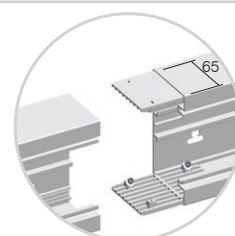

УНИВЕРСАЛЕН ЪГЛОВ ЕЛЕМЕНТ МА 130x65



- RT40ES
- RT40PW

- универсален ъглов елемент
- височина 130 mm
- в съответствие с EN 50085-1

UNIVERSAL CORNER MA 130x65

- universal corner element
- height 130mm
- in accordance with EN 50085-1



УНИВЕРСАЛЕН ЪГЛОВ ЕЛЕМЕНТ МА 165x65



- RT41ES
- RT41PW

- универсален ъглов елемент
- височина 165mm
- в съответствие с EN 50085-1

UNIVERSAL CORNER MA 165x65

- universal corner element
- height 165mm
- in accordance with EN 50085-1

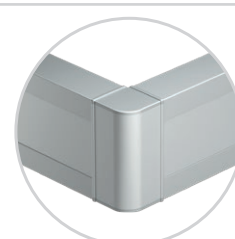

ЗАЗЕМИТЕЛЕН ЕЛЕМЕНТ МА 2 x A6.3



RT42

- заземителен елемент за заземяване на основата на канала и предния капак
- в съответствие с EN 50085-1

EARTHING PIECE MA 2x A6.3

- earthing piece for earthing of trunking base and front cover
- in accordance with EN 50085-1

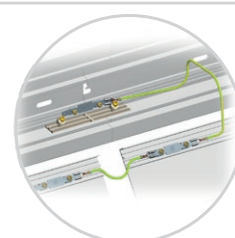

L-КОЛЯНО MA 130x65



- RT43ES
- RT43PW

- универсален елемент- L-коляно от алуминий
 - височина 130 mm, дължина 400 mm
 - в съответствие с EN 50085-1

L-BEND MA 130x65

- universal L bend element from aluminium
 - height 130mm, length 400mm
 - in accordance with EN 50085-1

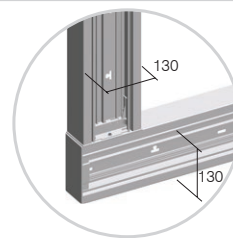

L-КОЛЯНО MA 165x65



- RT44ES
- RT44PW

- универсален елемент- L-коляно от алуминий
 - височина 165 mm, дължина 400 mm
 - свързване с MA 130x65
 - в съответствие с EN 50085-1

L-BEND MA 165x65

- universal L bend element from aluminium
 - height 165mm, length 400mm
 - connection on MA 130x65
 - in accordance with EN 50085-1

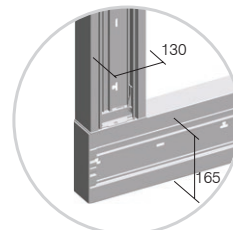

T-КОЛЯНО MA 130x65



- RT45ES
- RT45PW

- универсален елемент- T-коляно от алуминий
 - височина 130 mm, дължина 400 mm
 - в съответствие с EN 50085-1

T-BEND MA 130x65

- universal T bend element from aluminium
 - height 130mm, length 400mm
 - in accordance with EN 50085-1

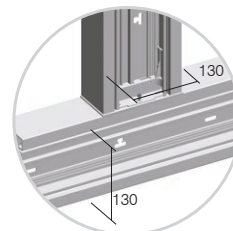

T-КОЛЯНО MA 165x65

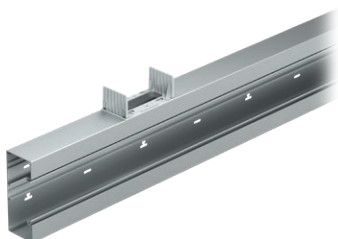

- RT46ES
- RT46PW

- универсален елемент- T-коляно от алуминий
 - височина 165 mm, дължина 400 mm
 - свързване с MA 130x65
 - в съответствие с EN 50085-1

T-BEND MA 165x65

- universal T bend element from aluminium
 - height 165mm, length 400mm
 - connection on MA 130x65
 - in accordance with EN 50085-1

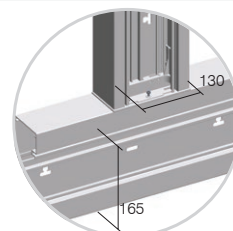

каналите MA се основават на модулна система за 2M, 4M или 7M комбинации от елементи
 MA trunking is based on modular system making 2M, 4M or 7M combinations of elements

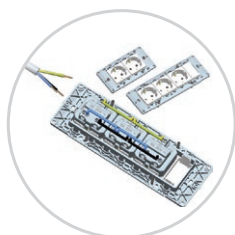

В Modul ние предоставяме специални елементи за бърз монтаж
 In Modul we provide special elements for quick installation

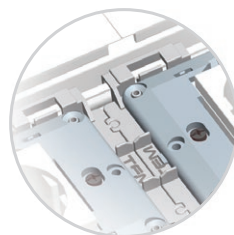

С Adapter MA се предоставя точно позициониране без излишни усилия
 With Adapter MA exact positioning without extra effort is provided

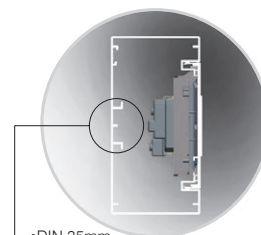

Монтаж без конзола означава повече място за кабели, DIN-релса базов профил EN-60715
 Mounted without box means more space for cables, DIN-rail base shape EN-60715

TRUNKING SYSTEM ALUMINIUM



ЕДИНИЧНА ЗАКРЕПВАЩА ПЛАСТИНА MA 130x65



- RT50ES
- RT50PW

- закрепваща пластина за закрепване на основа за канал MA130
върху под и/или на таван
- в съответствие с EN 50085-1

FIXING PLATE MA SINGLE 130x65

- fixing plate for fixing trunking base MA130 on the floor
and/or on the ceiling
- in accordance with EN 50085-1



- RT51ES
- RT51PW

ДВОЙНА ЗАКРЕПВАЩА ПЛАСТИНА MA 130x65

- закрепваща пластина за закрепване на две основи за
канал MA130 върху под и/или на таван
- в съответствие с EN 50085-1

FIXING PLATE MA DOUBLE 130x65

- fixing plate for fixing two trunking bases MA130 on the
floor and/or on the ceiling
- in accordance with EN 50085-1



СЕРВИЗНА КОЛОНА MA 130x65x500



- RT52ES
- RT52PW

- сервисна колона MA
- височина 500 mm
- включена в доставката монтажна рамка 7M
- в съответствие с EN 50085-1

SERVICE POST MA 130x65x500

- service post MA
- height 500mm
- mounting frame 7M included
- in accordance with EN 50085-1

ДВОЙНА СЕРВИЗНА КОЛОНА MA 130x130x500



- RT53ES
- RT53PW

- двойна сервисна колона MA
- височина 500 mm
- включена в доставката монтажни рамки 7M
- в съответствие с EN 50085-1

SERVICE POST MA DOUBLE 130x130x500

- service post MA double
- height 500mm
- mounting frames 7M included
- in accordance with EN 50085-1

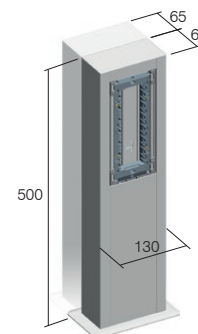

Сечение на кабел / Cable intersection mm ²	Напречно сечение на кабелите / Cable cross-section (mm ²)				
	1 проводник / 1 wire	2 проводника / 2 wires	3 проводника / 3 wires	4 проводника / 4 wires	5 проводника / 5 wires
1,5	44	111	121	144	169
2,5	49	133	157	169	211
4	58	169	183	211	256
6	68	196	225	256	307

Вместимост на канал за кабели / Trunk capacity				
Канал за кабели / Trunk	MA 130x65	MA 130x65	MA 165x65	MA 130x65
	празен / empty	с ключове и контакти Modul / with Modul switches and sockets	празен / empty	с ключове и контакти Modul / with Modul switches and sockets
вместимост / capacity	7600 mm ²	5500 mm ²	9900 mm ²	7800 mm ²
max ø	54 mm	2x42 mm	54 mm	2x42 mm

П О Д О В И К О Н З О Л И М Т

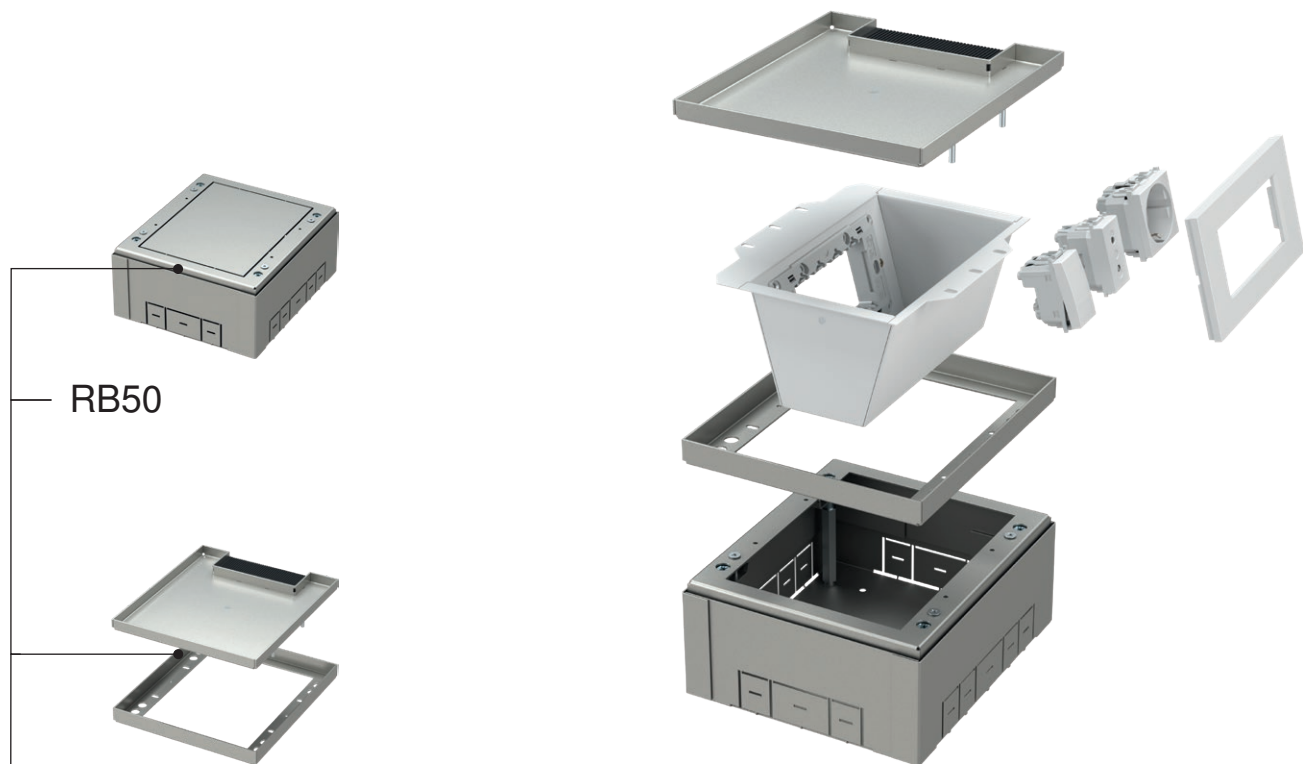

тип type	описание description	технически данни technical data
RB50	ОСНОВА ЗА ПОДОВА КОНЗОЛА FLOOR BOX BASE	4M
RB65S1	КАПАК ЗА ПОДОВА РАЗПРЕДЕЛИТЕЛНА КУТИЯ FLOOR DISTRIBUTION BOX COVER	4M
RB60	ВЛОЖКА ЗА ПОДОВА РАЗПРЕДЕЛИТЕЛНА КУТИЯ INSERT FOR FLOOR DISTRIBUTION BOX	4M
·	·	·
·	·	·

	RB65S1	RB66S1	RB67S2	RB68S2
X	177	178	265	516,5
Y	200,5	265	265	265
Z	17,5	17,5	17,5	17,5

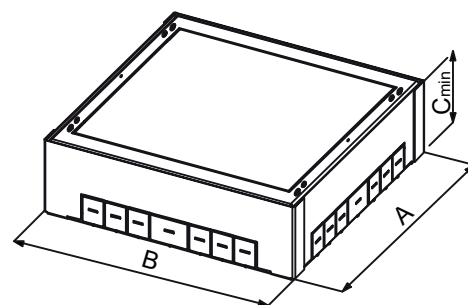
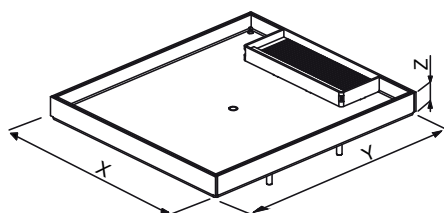

	RB50	RB51	RB52	RB53
A	208,5	273	273	273
B	182	182,5	269,5	521
C	83	83	83	83

F L O O R B O X E S M T

ОСНОВА ЗА ПОДОВА КОНЗОЛА 4М



RB50

- основа за подова конзола 4 М
- метална, с галванично покритие
- за инсталиране в под и в двоен под
- размери за монтаж 208,5 x 182 мм, дълбочина мин. 83 мм
- регулируема височина 83 – 128 мм
- в съответствие с EN 5005-1 в EN 50085-2-2

FLOOR BOX BASE 4M

- floor box base 4M
- metal, galvanized
- for installation in a floor or double floor
- mounting dimensions 208.5x182mm, min. depth 83mm
- adjustable height 83-128mm
- in accordance with EN 5005-1 and EN 50085-2-2

ВЛОЖКА ЗА ПОДОВА РАЗПРЕДЕЛИТЕЛНА КУТИЯ 4 М



RB60

- вложка за подова конзола 4 М
- метална, бял цвят RAL 9006
- включен МОДУЛ за монтажна рамка 4 М
- в съответствие с EN 5005-1 в EN 50085-2-2

INSERT FOR FLOOR DISTRIBUTION BOX 4M

- insert for floor box 4M
- metal, colour white RAL 9006
- mounting frame MODUL 4M included
- in accordance with EN 5005-1 and EN 50085-2-2

КАПАК ЗА ПОДОВА РАЗПРЕДЕЛИТЕЛНА КУТИЯ 4 М



RB65S1

- капак за подова конзола 4 М
- метална, с галванично покритие
- размери за монтаж 200,5 x 177 мм, дълбочина 17,5 мм
- дебелина на пода до 11,5 мм
- в съответствие с EN 5005-1 в EN 50085-2-2

FLOOR DISTRIBUTION BOX COVER 4M

- floor box cover 4M
- metal, galvanized
- mounting dimensions 200.5x177mm, depth 17.5mm
- floor thickness up to 11.5mm
- in accordance with EN 5005-1 and EN 50085-2-2

ОСНОВА ЗА ПОДОВА КОНЗОЛА 7 М



RB51

- основа за подова конзола 7 М
- метална, с галванично покритие
- за инсталиране в под и в двоен под
- размери за монтаж 273 x 182,5 мм, дълбочина мин. 83 мм
- регулируема височина 83 – 128 мм
- в съответствие с EN 5005-1 в EN 50085-2-2

FLOOR BOX BASE 7M

- floor box base 7M
- metal, galvanized
- for installation in a floor or double floor
- mounting dimensions 273x182.5mm, min. depth 83mm
- adjustable height 83-128mm
- in accordance with EN 5005-1 and EN 50085-2-2

ВЛОЖКА ЗА ПОДОВА РАЗПРЕДЕЛИТЕЛНА КУТИЯ 7 М



RB61

- вложка за подова конзола 7 М
- метална, бял цвят RAL 9006
- включен МОДУЛ за монтажна рамка 7 М
- в съответствие с EN 5005-1 в EN 50085-2-2

INSERT FOR FLOOR DISTRIBUTION BOX 7M

- insert for floor box 7M
- metal, colour white RAL 9006
- mounting frame MODUL 7M included
- in accordance with EN 5005-1 and EN 50085-2-2

КАПАК ЗА ПОДОВА РАЗПРЕДЕЛИТЕЛНА КУТИЯ 7 М

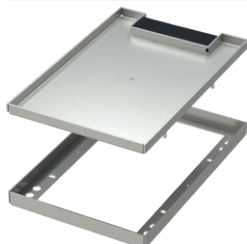

RB66S1

- капак за подова конзола 7 М
- метална, с галванично покритие
- размери за монтаж 265 x 178 мм, дълбочина 17,5 мм
- дебелина на пода до 11,5 мм
- в съответствие с EN 5005-1 в EN 50085-2-2

FLOOR DISTRIBUTION BOX COVER 7M

- floor box cover 7M
- metal, galvanized
- mounting dimensions 265x178mm, depth 17.5mm
- floor thickness up to 11.5mm
- in accordance with EN 5005-1 and EN 50085-2-2

ОСНОВА ЗА ПОДОВА КОНЗОЛА 2 X 7 М

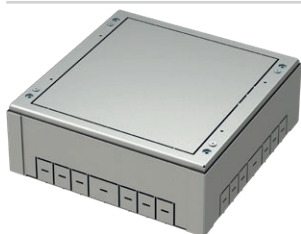

RB52

- основа за подова конзола 2 X 7 М
- метална, с галванично покритие
- за инсталиране в под и в двоен под
- размери за монтаж 273 x 269,5 мм, дълбочина мин. 83 мм
- регулируема височина 83 – 128 мм
- в съответствие с EN 5005-1 в EN 50085-2-2

FLOOR BOX BASE 2X7M

- floor box base 2X7M
- metal, galvanized
- for installation in a floor or double floor
- mounting dimensions 273x269.5mm, min. depth 83mm
- adjustable height 83-128mm
- in accordance with EN 5005-1 and EN 50085-2-2

ВЛОЖКА ЗА ПОДОВА РАЗПРЕДЕЛИТЕЛНА КУТИЯ 2X7 М



RB62

- вложка за подова конзола 2 x 7 М
- метална, бял цвят RAL 9006
- включен МОДУЛ за монтажни рамки 2x7M
- в съответствие с EN 5005-1 в EN 50085-2-2

INSERT FOR FLOOR DISTRIBUTION BOX 2X7M

- insert for floor box 2x7M
- metal, colour white RAL 9006
- mounting frames MODUL 2x7M included
- in accordance with EN 5005-1 and EN 50085-2-2

КАПАК ЗА ПОДОВА РАЗПРЕДЕЛИТЕЛНА КУТИЯ 2 X 7 М



RB67S2

- капак за подова конзола 2x7 М
- метална, с галванично покритие
- размери за монтаж 265 x 265 мм, дълбочина 17,5 мм
- дебелина на пода до 11,5 мм
- в съответствие с EN 5005-1 в EN 50085-2-2

FLOOR DISTRIBUTION BOX COVER 2X7M

- floor box cover 2x7M
- metal, galvanized
- mounting dimensions 265x265mm, depth 17.5mm
- floor thickness up to 11.5mm
- in accordance with EN 5005-1 and EN 50085-2-2

ОСНОВА ЗА ПОДОВА КОНЗОЛА 4 X 7 М

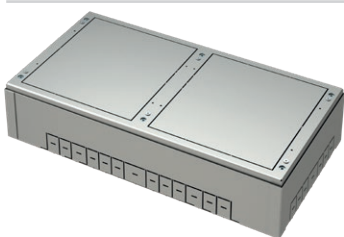

RB53

- основа за подова конзола 4 X 7 М
- метална, с галванично покритие
- за инсталиране в под и в двоен под
- размери за монтаж 273 x 521 мм, дълбочина мин. 83 мм
- регулируема височина 83 – 128 мм
- в съответствие с EN 5005-1 в EN 50085-2-2

FLOOR BOX BASE 4X7M

- floor box base 4X7M
- metal, galvanized
- for installation in a floor or double floor
- mounting dimensions 273x521mm, min. depth 83mm
- adjustable height 83-128mm
- in accordance with EN 5005-1 and EN 50085-2-2

ВЛОЖКА ЗА ПОДОВА РАЗПРЕДЕЛИТЕЛНА КУТИЯ 2X7 М



RB62

- вложка за подова конзола 2 x 7 М
- метална, бял цвят RAL 9006
- включен МОДУЛ за монтажни рамки 2x7M
- в съответствие с EN 5005-1 в EN 50085-2-2

INSERT FOR FLOOR DISTRIBUTION BOX 2X7M

- insert for floor box 2x7M
- metal, colour white RAL 9006
- mounting frames MODUL 2x7M included
- in accordance with EN 5005-1 and EN 50085-2-2

КАПАК ЗА ПОДОВА РАЗПРЕДЕЛИТЕЛНА КУТИЯ 4 X 7 М



RB68S2

- капак за подова конзола 4 x 7 М
- метална, с галванично покритие
- размери за монтаж 265 x 516,5 мм, дълбочина 17,5 мм
- дебелина на пода до 11,5 мм
- в съответствие с EN 5005-1 в EN 50085-2-2

FLOOR DISTRIBUTION BOX COVER 4X7M

- floor box cover 4x7M
- metal, galvanized
- mounting dimensions 265x516.5mm, depth 17.5mm
- floor thickness up to 11.5mm
- in accordance with EN 5005-1 and EN 50085-2-2



RB55S1

тип type	описание description	технически данни technical data
RB55S1	ПОДОВА КОНЗОЛА С КАПАК ЗА ДВОЕН ПОД FLOOR BOX WITH COVER FOR DOUBLE FLOORS	4M
RB60	ВЛОЖКА ЗА ПОДОВА РАЗПРЕДЕЛИТЕЛНА КУТИЯ INSERT FOR FLOOR DISTRIBUTION BOX	4M
⋮	⋮	⋮
⋮	⋮	⋮

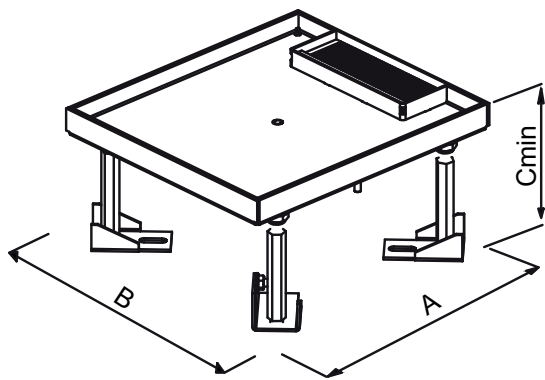

	RB55S1	RB56S1	RB57S2	RB58S2
A	200,5	265	265	265
B	177	178	265	516,5
C	100	100	100	100

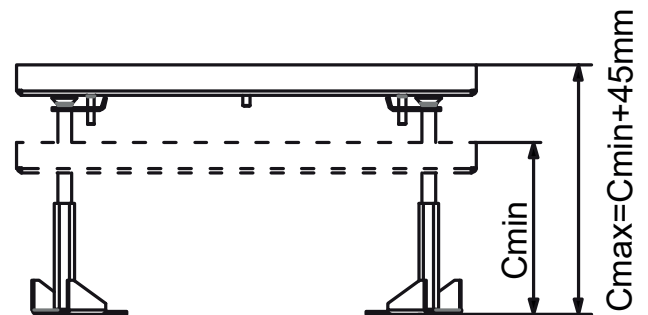

ПОДОВА КОНЗОЛА С КАПАК ЗА ДВОЕН ПОД 4 М



RB55S1

- основа за подова конзола 4 М
- метална, с галванично покритие
- размери за монтаж 200,5 x 177 мм, дълбочина мин. 100 мм
- регулируема височина 100 – 145 мм
- дебелина на пода до 11,5 мм
- в съответствие с EN 5005-1 в EN 50085-2-2

FLOOR BOX WITH COVER FOR DOUBLE FLOORS 4M

- floor box base 4M
- metal, galvanized
- mounting dimensions 200.5x177mm, min. depth 100mm
- adjustable height 100-145mm
- floor thickness up to 11.5mm
- in accordance with EN 5005-1 and EN 50085-2-2

ВЛОЖКА ЗА ПОДОВА РАЗПРЕДЕЛИТЕЛНА КУТИЯ 4 М



RB60

- вложка за подова конзола 4 М
- метална, бял цвят RAL 9006
- включен МОДУЛ за монтажна рамка 4 М
- в съответствие с EN 5005-1 в EN 50085-2-2

INSERT FOR FLOOR DISTRIBUTION BOX 4M

- insert for floor box 4M
- metal, colour white RAL 9006
- mounting frame MODUL 4M included
- in accordance with EN 5005-1 and EN 50085-2-2

ПОДОВА КОНЗОЛА С КАПАК ЗА ДВОЕН ПОД 7 М



RB56S1

- основа за подова конзола 7 М
- метална, с галванично покритие
- размери за монтаж 265 x 178 мм, дълбочина мин. 100 мм
- регулируема височина 100 – 145 мм
- дебелина на пода до 11,5 мм
- в съответствие с EN 5005-1 в EN 50085-2-2

FLOOR BOX WITH COVER FOR DOUBLE FLOORS 7M

- floor box base 7M
- metal, galvanized
- mounting dimensions 265x178mm, min. depth 100mm
- adjustable height 100-145mm
- floor thickness up to 11.5mm
- in accordance with EN 5005-1 and EN 50085-2-2

ВЛОЖКА ЗА ПОДОВА РАЗПРЕДЕЛИТЕЛНА КУТИЯ 7 М



RB61

- вложка за подова конзола 7 М
- метална, бял цвят RAL 9006
- включен МОДУЛ за монтажна рамка 7 М
- в съответствие с EN 5005-1 в EN 50085-2-2

INSERT FOR FLOOR DISTRIBUTION BOX 7M

- insert for floor box 7M
- metal, colour white RAL 9006
- mounting frame MODUL 7M included
- in accordance with EN 5005-1 and EN 50085-2-2

ПОДОВА КОНЗОЛА С КАПАК ЗА ДВОЕН ПОД 2 X 7 М



RB57S2

- основа за подова конзола 2 X 7 М
- метална, с галванично покритие
- размери за монтаж 265 x 265 мм, дълбочина мин. 100 мм
- регулируема височина 100 – 145 мм
- дебелина на пода до 11,5 мм
- в съответствие с EN 5005-1 в EN 50085-2-2

FLOOR BOX WITH COVER FOR DOUBLE FLOORS 2X7M

- floor box base 2x7M
- metal, galvanized
- mounting dimensions 265x265mm, min. depth 100mm
- adjustable height 100-145mm
- floor thickness up to 11.5mm
- in accordance with EN 5005-1 and EN 50085-2-2

ВЛОЖКА ЗА ПОДОВА РАЗПРЕДЕЛИТЕЛНА КУТИЯ 2X7 М



RB62

- вложка за подова конзола 2 x 7 М
- метална, бял цвят RAL 9006
- включен МОДУЛ за монтажни рамки 2x7М
- в съответствие с EN 5005-1 в EN 50085-2-2

INSERT FOR FLOOR DISTRIBUTION BOX 2X7M

- insert for floor box 2x7M
- metal, colour white RAL 9006
- mounting frames MODUL 2x7M included
- in accordance with EN 5005-1 and EN 50085-2-2

ПОДОВА КОНЗОЛА С КАПАК ЗА ДВОЕН ПОД 4 X 7 М



RB58S2

- основа за подова конзола 4 X 7 М
- метална, с галванично покритие
- размери за монтаж 265 x 516,5 мм, дълбочина мин. 100 мм
- регулируема височина 100 – 145 мм
- дебелина на пода до 11,5 мм
- в съответствие с EN 5005-1 в EN 50085-2-2

FLOOR BOX WITH COVER FOR DOUBLE FLOORS 4X7M

- floor box base 4x7M
- metal, galvanized
- mounting dimensions 265x516.5mm, min. depth 100mm
- adjustable height 100-145mm
- floor thickness up to 11.5mm
- in accordance with EN 5005-1 and EN 50085-2-2

ВЛОЖКА ЗА ПОДОВА РАЗПРЕДЕЛИТЕЛНА КУТИЯ 2X7 М



RB62

- вложка за подова конзола 2 x 7 М
- метална, бял цвят RAL 9006
- включен МОДУЛ за монтажни рамки 2x7М
- в съответствие с EN 5005-1 в EN 50085-2-2

INSERT FOR FLOOR DISTRIBUTION BOX 2X7M

- insert for floor box 2x7M
- metal, colour white RAL 9006
- mounting frames MODUL 2x7M included
- in accordance with EN 5005-1 and EN 50085-2-2

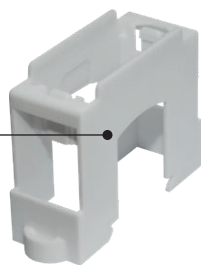
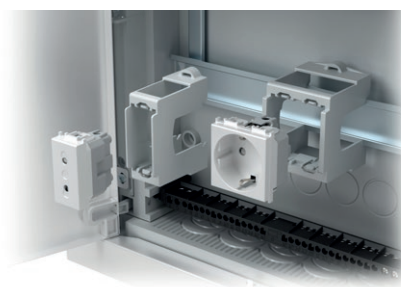
RB10

тип type	описание description	технически данни technical data
RB10	АДАПТЕР ЗА DIN РЕЛСА ADAPTER FOR DIN RAIL	35mm 1M
RB11	АДАПТЕР ЗА DIN РЕЛСА ADAPTER FOR DIN RAIL	35mm 2M
·	РАЗПРЕДЕЛИТЕЛНА КУТИЯ	·
·	·	·
·	·	·

АДАПТЕР ЗА DIN РЕЛСА 35 mm 1M

RB10

- адаптер MODUL 1M
- за DIN релса 35 mm
- в съответствие с EN 50022

ADAPTER FOR DIN RAIL 35mm 1M

- adapter MODUL 1M
- for DIN rail 35mm
- in accordance with EN 50022

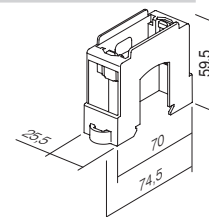

АДАПТЕР ЗА DIN РЕЛСА 35 mm 2M

RB11

- адаптер MODUL 2M
- за DIN релса 35 mm
- в съответствие с EN 50022

ADAPTER FOR DIN RAIL 35mm 2M

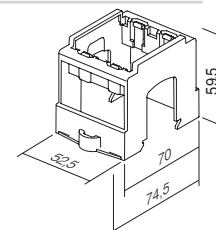
- adapter MODUL 2M
- for DIN rail 35mm
- in accordance with EN 50022



SWITCH
LOGIQ



TEM

LOGIQ

ПЪЛНА УВЕРЕНОСТ създадено за всяка стая

Форма за всяка стая. Ключовете имат универсални линии, които привличат вниманието, както в модерни работни среди, така и в уютни, комфортни жилищни пространства. Семейството LOGIQ предлага просто и логично решение за всяко ваше желание.

OMNIPRESENT CONFIDENCE made for every room

A shape for every room. The switches have universal lines that leave a mark in both modern work environments as well as in cosy, comfortable living spaces. The LOGIQ family offers a simple and logical solution for your every wish.



LOGIQ

ХАРМОНИЯ НА ЦВЕТОВЕТЕ Изберете своя нюанс

Семейството LOGIQ се гордее с логичната си гама от утвърдени и елегантни нюанси, познати и обичани от нашите клиенти. Не правете компромиси, семейството LOGIQ предлага това, което искате. Винаги можем да създадем цветния нюанс според вашата специална заявка. Логично.

HARMONY OF COLOURS Choose your hue

The LOGIQ family prides itself on its logical range of verified and elegant hues known and loved by our clients. Don't compromise, the LOGIQ family has you covered. We can always create the hue of colour in accordance with your special request. Logically.

- антрацит *anthracite*
- титан *titanium*
- полярно бяло *polar white*

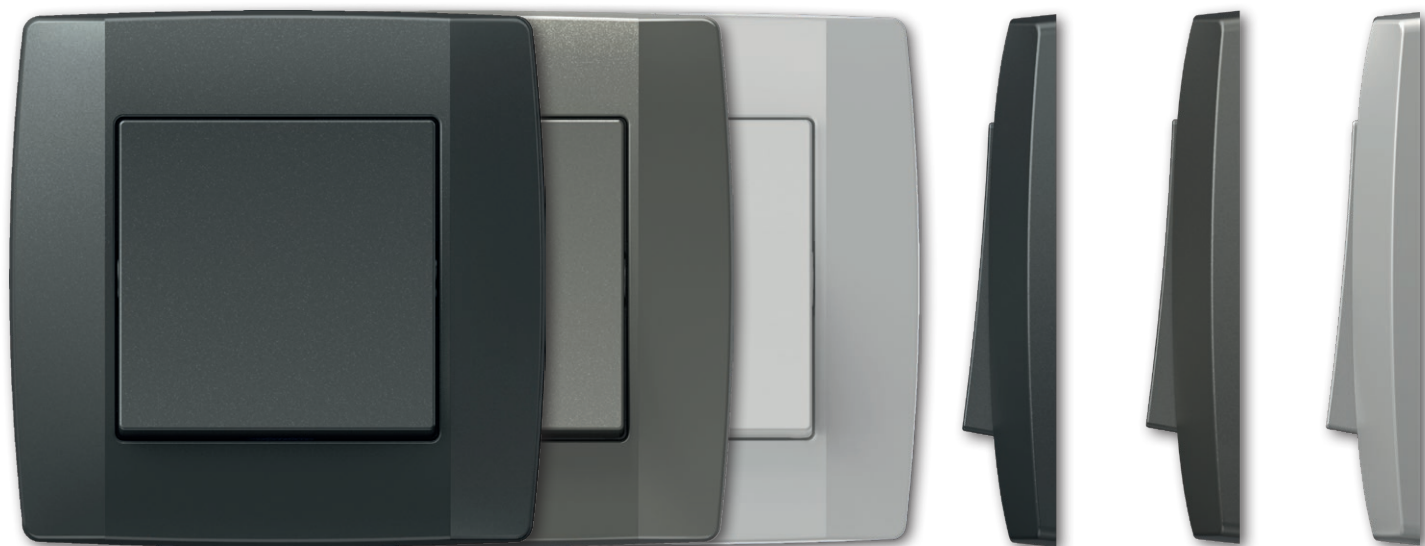

НЕОГРАНИЧЕНО ВЪОБРАЖЕНИЕ Създайте своя собствена комбинация

Семейството LOGIQ ви дава възможност да създадете своя собствена комбинация. За да опростим комбинирането, създадохме полезна система, която поддържа последователното свързване на хоризонтални и вертикални линии. Така наречената система 55/55 ви дава възможност да използвате едни и същи универсални елементи всеки път. Знаете какво искате? Не се тревожете, ключовете LOGIQ могат да четат мислите ви.

LIMITLESS IMAGINATION Create your own combination

The LOGIQ family allows you to create your own combination. To make combining simple, we have created a useful system that supports the sequencing of horizontal and vertical lines. The so-called 55/55 system allows you to use the same universal elements every time. Know what you want? Don't worry, the LOGIQ switches can read your mind.



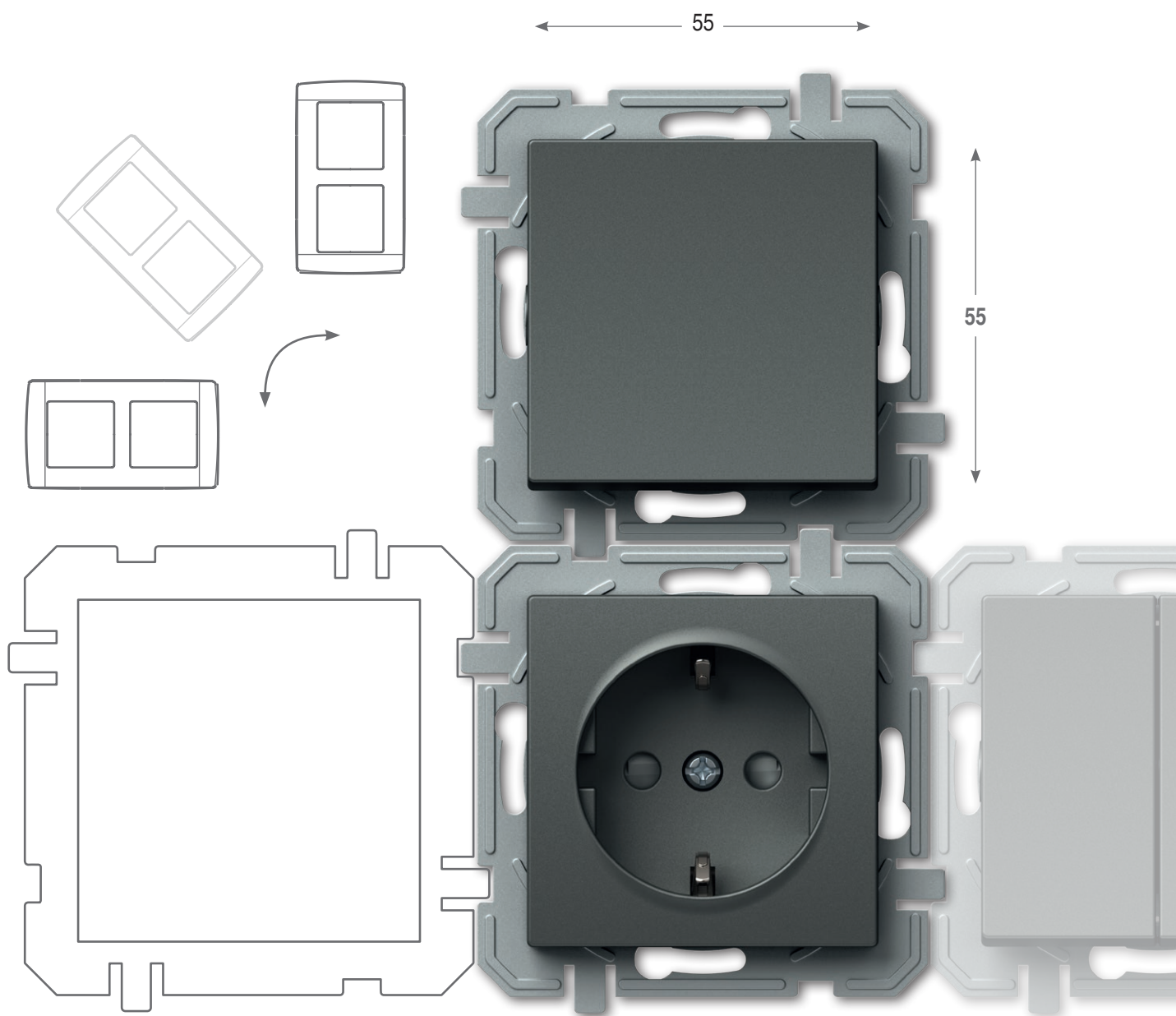

ОПТОСТЕНО ЗА НАЙ-ВЗИСКАТЕЛНИТЕ

Семейството LOGIQ предлага ключове, регулатори, датчици и контакти за всяка цел на едно място. Можете да използвате тези продукти поотделно или в последователна верига. Като всяко семейство, което се разраства и развива, семейството LOGIQ ще продължи да развива гамата си от продукти според вашите нужди и желания. С радост се вслушваме във вас и предлагаме решение, което ще продължи просто и логично историята на семейството LOGIQ.

SIMPLE FOR THE MOST DEMANDING

The LOGIQ family offers switches, regulators, sensors, and sockets for every purpose in one place. You can use these products individually or in a sequence. Just like every family that grows and develops, the LOGIQ family will continue to develop our range of products in accordance with your needs and wishes. We are happy to listen to you and offer a solution which will simply and logically continue the story of the LOGIQ family.



ВСИЧКО НА ЕДНО МЯСТО И ОЩЕ

ALL IN ONE PLACE AND MORE

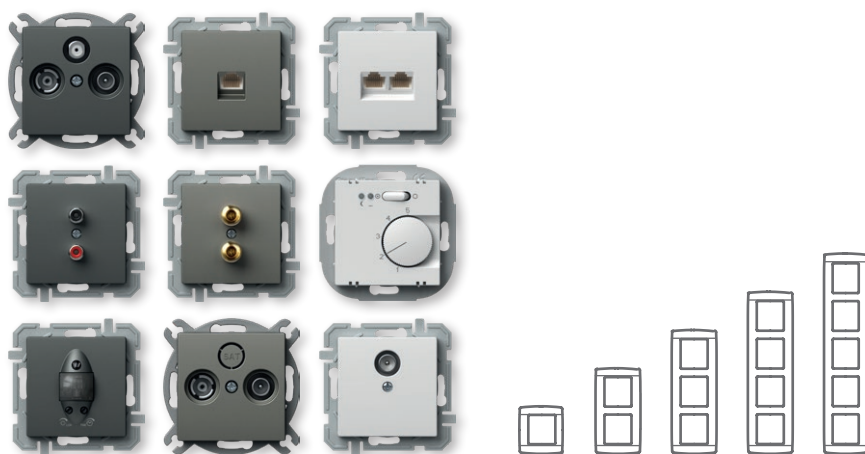

ЛОГИЧЕН МОНТАЖ

LOGIQ е решение за системата от стандартизирани кръгли инсталационни кутии. Може да се използва както за прости, така и за по-взискателни инсталации, нови сгради и приспособления. Системата се характеризира с контакти чрез вкарване, които спестяват време при монтажа на елементите.

LOGICAL INSTALLATION

LOGIQ is a solution for the system of standardized round installations boxes. It can be used for simple as well as more demanding installations, new buildings and adaptations. The system is characterised by plug-in contacts which save time during installation of elements.

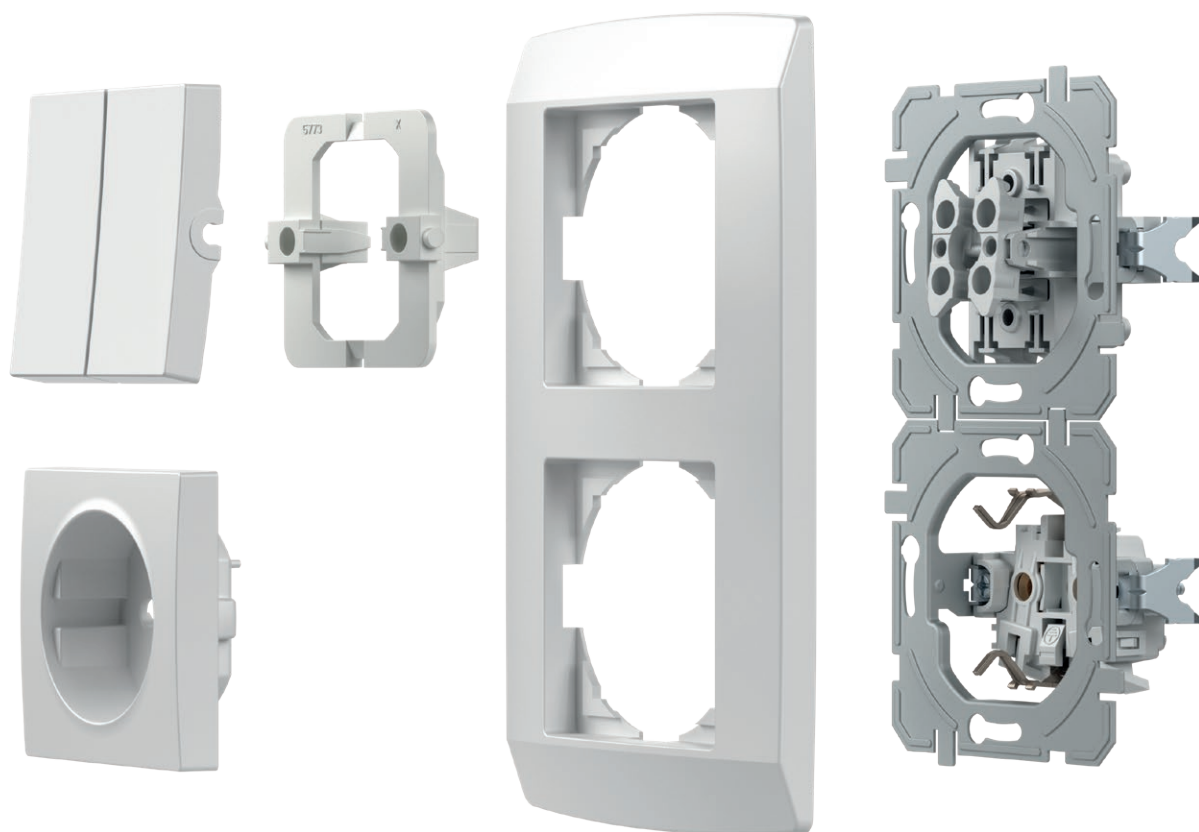

ДОБРЕ Е ДА ЗНАЕТЕ

GOOD TO KNOW



Всички контакти са оборудвани за безопасно изключване, което гарантира защитата на контактите, които са под напрежение.

All the sockets are equipped with a safety shutters assuring the protection to live contacts.



Добре планирана конструкция на ключа дава възможност лесното осветление да бъде свързано и последователно.

A well-planned switch construction makes easy illumination possible also subsequently.



Контактите, изработени от сребърна сплав, гарантират безопасно включване.

Contacts made of silver alloy guarantee safe switching.



Контактите, осъществявани чрез вкарване на проводниците, позволяват бързо и надеждно закрепване на проводниците. Два проводника с различни диаметри може да се свържат към един и същи контакт.

Plug-in contacts enable quick and reliable attachment of wires. Two wires of different diameters can be attached to the same contact.



Закрепващите крачета дават възможност за по-дълбоко закрепване (също така и през керамични плочки и подобни)

Fixing claws enable deeper fixing (also through ceramic tiles, etc.)



Лесните за монтиране инсталационни конзоли ще улеснят работата ви. Правилните дължини са гарантирани.

Easy-fitting installation boxes will make your work easier. Proper lengths are guaranteed.

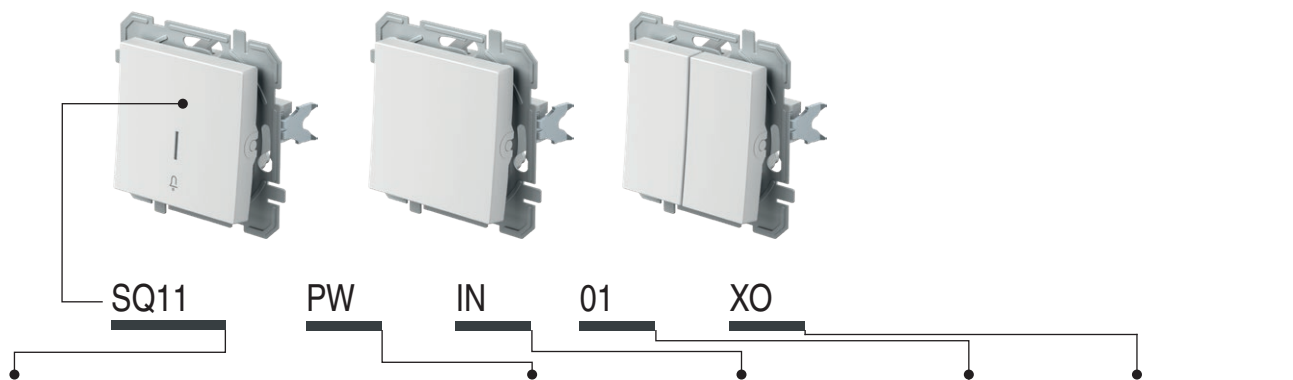

тип type	описание description	технически данни technical data	цвет colour	допълнителна информация 1 optional data 1	допълнителна информация 2 optional data 2	допълнителна информация 3 optional data 3
SQ10	КЛЮЧ 1WAY SWITCH 1WAY	10AX 250V~	<input type="checkbox"/> PW полярно бяло polar white	NT неутрален neutral	01	XO без декоративен панел without cover plate
SQ11	БУТОН 1WAY PUSH BUTTON 1WAY	10A 250V~	<input type="checkbox"/> TI титан titanium	IN индикатор indicator	02	
SQ22	КЛЮЧ 2POLE SWITCH 2POLE	16AX 250V~	<input type="checkbox"/> AT антрацит anthracite	03		
...

КЛЮЧ 1WAY 10AX 250V~



- SQ10PWXO
- SQ10TIXO
- SQ10ATXO



- 10AX 250V~, тип SQ10
 - в съответствие с EN 60669-1
 - контакти чрез вкарване 1,5-2,5 mm²
 SWITCH 1WAY 10AX 250V~
 - 10AX 250V~, type SQ10
 - in accordance with EN 60669-1
 - plug-in contacts 1.5-2.5mm²



КЛЮЧ 1WAY 10AX 250V~ __ IN

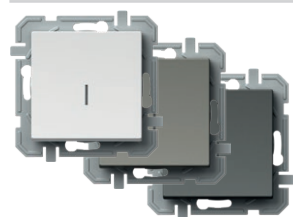

- SQ10PWINXO
- SQ10TIINXO
- SQ10ATINXO



- IN индикатор, без неонна лампа
 - 10AX 250V~, тип SQ10
 - в съответствие с EN 60669-1
 - контакти чрез вкарване 1,5-2,5 mm²
 SWITCH 1WAY 10AX 250V~ __ IN
 - IN indicator, without neon lamp
 - 10AX 250V~, type SQ10
 - in accordance with EN 60669-1
 - plug-in contacts 1.5-2.5mm²



БУТОН 1WAY 10A 250V~



- SQ11PWXO
- SQ11TIXO
- SQ11ATXO

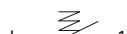

- 10A 250V~, тип SQ11
 - в съответствие с EN 60669-1
 - контакти чрез вкарване 1,5-2,5 mm²
 PUSH BUTTON 1WAY 10A 250V~
 - 10A 250V~, type SQ11
 - in accordance with EN 60669-1
 - plug-in contacts 1.5-2.5mm²



БУТОН 1WAY 10A 250V~ __ IN 01



- SQ11PWIN01XO
- SQ11TIIN01XO
- SQ11ATIN01XO

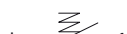

- IN 01 звънчев индикатор, без неонна лампа
 - 10A 250V~, тип SQ11
 - в съответствие с EN 60669-1
 - контакти чрез вкарване 1,5-2,5 mm²
 PUSH BUTTON 1WAY 10A 250V~ __ IN 01
 - IN 01 indicator bell, without neon lamp
 - 10A 250V~, type SQ11
 - in accordance with EN 60669-1
 - plug-in contacts 1.5-2.5mm²





- SQ11PWIN02XO
- SQ11TIIN02XO
- SQ11ATIN02XO



БУТОН 1WAY 10A 250V~ __ IN 02

- IN 02 светлинен индикатор, без неонева лампа
- 10A 250V~, тип SQ11
- в съответствие с EN 60669-1
- контакти чрез вкарване 1,5-2,5 mm²

PUSH BUTTON 1WAY 10A 250V~ __ IN 02

- IN 02 indicator light, without neon lamp
- 10A 250V~, type SQ11
- in accordance with EN 60669-1
- plug-in contacts 1.5-2.5mm²

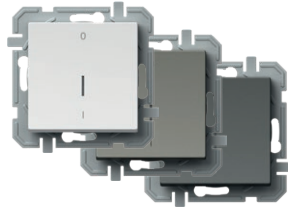

- SQ22PWIN03XO
- SQ22TIIN03XO
- SQ22ATIN03XO

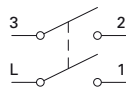

КЛЮЧ 2POLE 16AX 250V~ __ IN 03

- IN 03 неутрален 0-1, без неонева лампа
- 16AX 250V~, тип SQ22
- в съответствие с EN 60669-1
- винтови контакти 1,5-2,5 mm²

SWITCH 2POLE 16AX 250V~ __ IN 03

- IN 03 neutral 0-1, without neon lamp
- 16AX 250V~, type SQ22
- in accordance with EN 60669-1
- screw contacts 1.5-2.5mm²



- SQ50PWXO
- SQ50TIXO
- SQ50ATXO

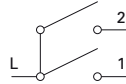

КЛЮЧ 2GANG-1WAY 10AX 250V~

- 10AX 250V~, тип SQ50
- в съответствие с EN 60669-1
- контакти чрез вкарване 1,5-2,5 mm²

SWITCH 2GANG-1WAY 10AX 250V~

- 10AX 250V~, type SQ50
- in accordance with EN 60669-1
- plug-in contacts 1.5-2.5mm²



- SQ51PWXO
- SQ51TIXO
- SQ51ATXO

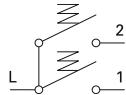

БУТОН 2GANG-1WAY 10A 250V~

- 10A 250V~, тип SQ51
- в съответствие с EN 60669-1
- контакти чрез вкарване 1,5-2,5 mm²

PUSH BUTTON 2GANG-1WAY 10A 250V~

- 10A 250V~, type SQ51
- in accordance with EN 60669-1
- plug-in contacts 1.5-2.5mm²

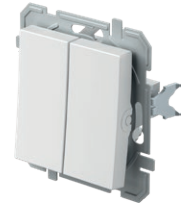

- SQ52PWNT09XO
- SQ52TINT09XO
- SQ52ATNT09XO

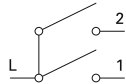

КЛЮЧ ЗА ЩОРИ 10AX 250V~ __ NT 09

- NT 09 неутрално положение – нагоре-надолу
- 10AX 250V~, тип SQ52
- в съответствие с EN 60669-1
- контакти чрез вкарване 1,5-2,5 mm²
- с механична блокировка

SWITCH SHUTTERS 10AX 250V~ __ NT 09

- NT 09 neutral up-down
- 10AX 250V~, type SQ52
- in accordance with EN 60669-1
- plug-in contacts 1.5-2.5mm²
- with mechanical interblock



- SQ53PWNT09XO
- SQ53TINT09XO
- SQ53ATNT09XO

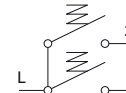

БУТОН ЗА ЩОРИ 10A 250V~ __ NT 09

- NT 09 неутрално положение – нагоре-надолу
- 10A 250V~, тип SQ53
- в съответствие с EN 60669-1
- контакти чрез вкарване 1,5-2,5 mm²
- с механична блокировка

PUSH BUTTON SHUTTERS 10A 250V~ __ NT 09

- NT 09 neutral up-down
- 10A 250V~, type SQ53
- in accordance with EN 60669-1
- plug-in contacts 1.5-2.5mm²
- with mechanical interblock

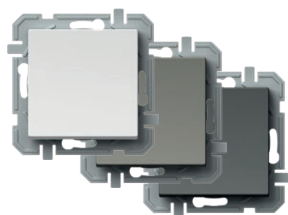

- SQ60PWXO
- SQ60TIXO
- SQ60ATXO

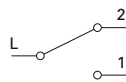

КЛЮЧ 2WAY 10AX 250V~

- 10AX 250V~, тип SQ60
- в съответствие с EN 60669-1
- контакти чрез вкарване 1,5-2,5 mm²

SWITCH 2WAY 10AX 250V~

- 10AX 250V~, type SQ60
- in accordance with EN 60669-1
- plug-in contacts 1.5-2.5mm²



ДВОЕН КЛЮЧ 2WAY 10AX 250V~



- SQ63PWXO
- SQ63TIXO
- SQ63ATXO



- 10AX 250V~, тип SQ63
 - в съответствие с EN 60669-1
 - контакти чрез вкарване 1,5-2,5 mm²
SWITCH DOUBLE 2WAY 10AX 250V~
 - 10AX 250V~, type SQ63
 - in accordance with EN 60669-1
 - plug-in contacts 1.5-2.5mm²



КРЪСТАТ КЛЮЧ 10AX 250V~

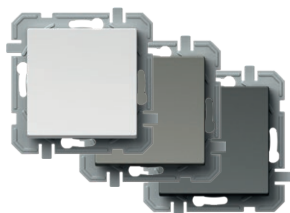

- SQ70PWXO
- SQ70TIXO
- SQ70ATXO



- 10AX 250V~, тип SQ70
 - в съответствие с EN 60669-1
 - контакти чрез вкарване 1,5-2,5 mm²
SWITCH INTERMEDIATE 10AX 250V~
 - 10AX 250V~, type SQ70
 - in accordance with EN 60669-1
 - plug-in contacts 1.5-2.5mm²



SQ10
SQ11

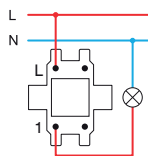

SQ22

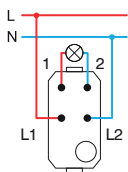

SQ50
SQ51

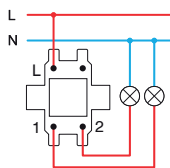

SQ52
SQ53

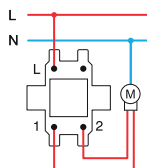

SQ60+SQ60

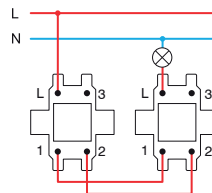

SQ63+SQ63

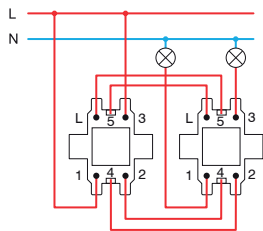

SQ60+SQ70+SQ60

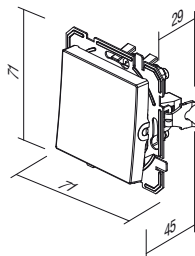
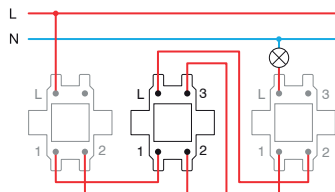

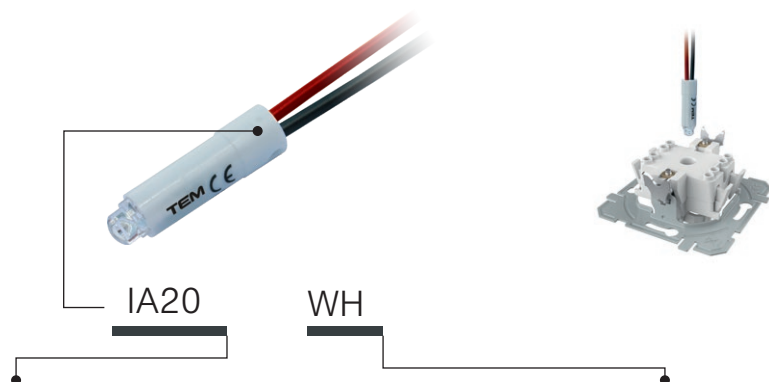

тип type	описание description	технически данни technical data	ЦВЯТ colour
IA10	НЕОНОВА ЛАМПА NEON LAMP	230V~ 0,34W	<input type="checkbox"/> WH бяло white
IA20	СВЕТОДИОДНА ЛАМПА LED LAMP	230V~ 0,40W	<input checked="" type="checkbox"/> BL синьо blue
IA21	СВЕТОДИОДНА ЛАМПА LED LAMP	24V AC/DC 0,20W	<input checked="" type="checkbox"/> RD червено red
.	.	.	<input checked="" type="checkbox"/> GR зелено green
.	.	.	<input checked="" type="checkbox"/> OR оранжево orange

НЕОНОВА ЛАМПА 230V~ 0,34W

 IA10OR

- за индикация, осветление или постоянно осветяване на ключа
- в комбинация с бутон с индикатор

NEON LAMP 230V~ 0,34W

- for indication, illumination or constant illumination of switch
- in combination with button with indicator

СВЕТОДИОДНА ЛАМПА 230V AC/DC 0,40W



 IA20WH
 IA20GR
 IA20RD
 IA20BL

- за индикация, осветление или постоянно осветяване на ключа
- в комбинация с бутон с индикатор

LED LAMP 230V AC/DC 0,40W

- for indication, illumination or constant illumination of switch
- in combination with button with indicator

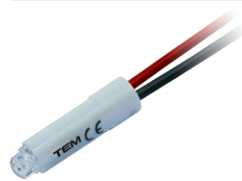
СВЕТОДИОДНА ЛАМПА 24V AC/DC 0,20W

 IA21WH
 IA21RD

- за индикация, осветление или постоянно осветяване на ключа
- в комбинация с бутон с индикатор

LED LAMP 24V AC/DC 0,20W

- for indication, illumination or constant illumination of switch
- in combination with button with indicator

СВЕТОДИОДНА ЛАМПА 12V AC/DC 0,10W

 IA22WH
 IA22RD

- за индикация, осветление или постоянно осветяване на ключа
- в комбинация с бутон с индикатор

LED LAMP 12V AC/DC 0,10W

- for indication, illumination or constant illumination of switch
- in combination with button with indicator

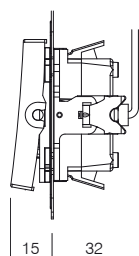

15

32

Индикация
Indication

*Осветление
Illumination

Постоянно осветление
Illumination always on

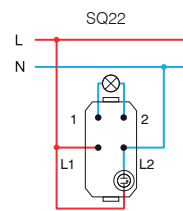
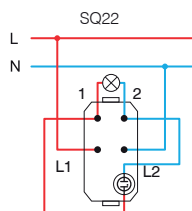
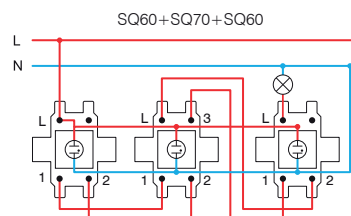
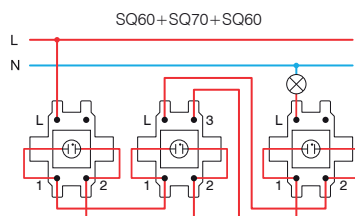
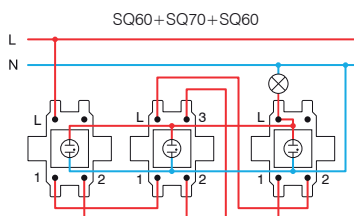
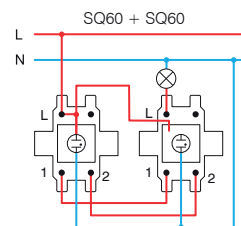
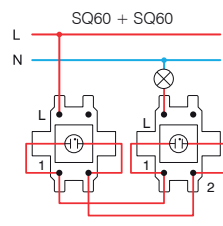
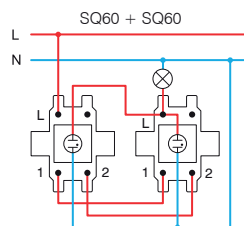
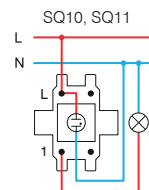
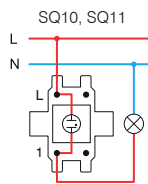
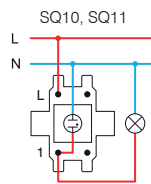

* връзките не са подходящи за енергоспестяващи крушки (CFL, LED) /
the connections are not suitable for energy-saving bulbs (CFL, LED)

S O C K E T S V Q

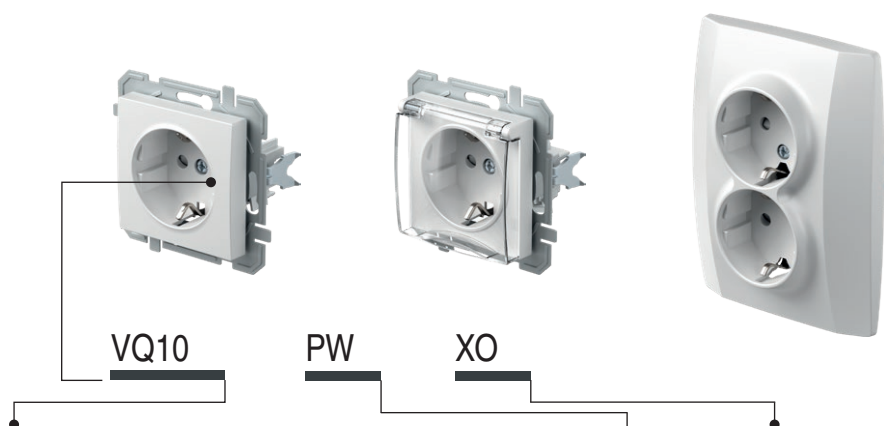

тип type	описание description	технически данни technical data	допълнителна информация 1 optional data 1
VQ10	КОНТАКТ ШУКО SOCKET SCHUKO	2P+E 16A 250V~	XO без декоративен панел without cover plate
VQ11	КОНТАКТ ШУКО+КАПАК SOCKET SCHUKO+COVER	2P+E 16A 250V~	
VQ12	КОНТАКТ ШУКО SOCKET SCHUKO	2P+E 16A 250V~ BV	
.	.	.	

ЦВЯТ
colour

<input type="checkbox"/> PW	полярно бяло polar white	<input type="checkbox"/> PT	бяло + прозрачно white+transparent	<input type="checkbox"/> PP	бяло + бяло white+white
<input type="checkbox"/> TI	титан titanium	<input type="checkbox"/> TT	титан + прозрачно titanium+transparent	<input type="checkbox"/> TI	титан + титан titanium+titanium
<input type="checkbox"/> AT	антрацит anthracite	<input type="checkbox"/> AT	антрацит + прозрачно anthracite+transparent	<input type="checkbox"/> AA	антрацит + антрацит anthracite+anthracite
<input type="checkbox"/> RD	червено red	<input type="checkbox"/> RT	червено + прозрачно red+transparent	<input type="checkbox"/> RR	червено + червено red+red
<input type="checkbox"/> GR	зелено green	<input type="checkbox"/> GT	зелено + прозрачно green+transparent	<input type="checkbox"/> GG	зелено + зелено green+green
<input type="checkbox"/> OR	оранжево orange	<input type="checkbox"/> OT	оранжево + прозрачно orange+transparent	<input type="checkbox"/> OO	оранжево + оранжево orange+orange



шuko - в съответствие с EN 60884-1, CEE7 (лист със стандарти III)

schuko - in accordance with EN 60884-1, CEE7 (standard sheet III)

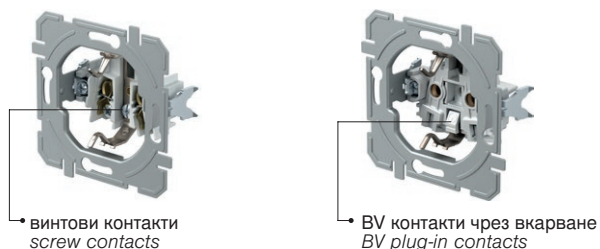

• винтови контакти
screw contacts

• BV контакти чрез вкарване
BV plug-in contacts

КОНТАКТ ШУКО 2P+E 16A 250V~ __ XO

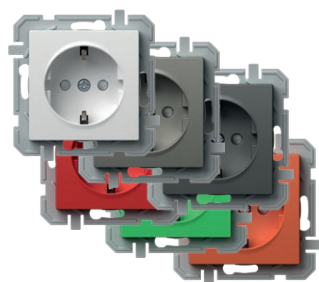

- VQ10PWXO
- VQ10TIXO
- VQ10ATXO
- VQ10RDXO
- VQ10GRXO
- VQ10ORXO

- винтови контакти 1,5-2,5 mm²
 - XO без панел
 - 2P+E шуко
 - 16A 250V~, тип VQ10
 - KS вградена защита за деца – вградена защита от допир на контакти
- SOCKET SCHUKO 2P+E 16A 250V~ __ XO**
- screw contacts 1.5-2.5mm²
 - XO without surround
 - 2P+E schuko
 - 16A 250V~, type VQ10
 - KS build-in child protection – shuttered live contacts



КОНТАКТ ШУКО+КАПАК 2P+E 16A 250V~ __ XO

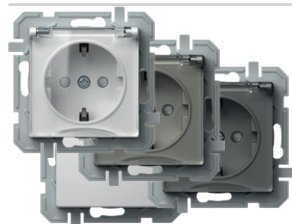

- VQ11PTXO
- VQ11TTXO
- VQ11ATXO
- VQ11PPXO

- винтови контакти 1,5-2,5 mm²
 - XO без панел
 - 2P+E шуко+капак
 - 16A 250V~, тип VQ11
 - KS вградена защита за деца – вградена защита от допир на контакти
- SOCKET SCHUKO+COVER 2P+E 16A 250V~ __ XO**
- screw contacts 1.5-2.5mm²
 - XO without surround
 - 2P+E schuko+cover
 - 16A 250V~, type VQ11
 - KS build-in child protection – shuttered live contacts



КОНТАКТ ШУКО 2P+E 16A 250V~ BV __ XO



- VQ12PWXO
- VQ12TIXO
- VQ12ATXO
- VQ12RDXO
- VQ12GRXO
- VQ12ORXO

- BV контакти чрез вкарване 1,5-2,5 mm²
 - XO без панел
 - 2P+E шуко
 - 16A 250V~, тип VQ12
 - KS вградена защита за деца – вградена защита от допир на контакти
- SOCKET SCHUKO 2P+E 16A 250V~ BV __ XO**
- BV plug-in contacts 1.5-2.5mm²
 - XO without surround
 - 2P+E schuko
 - 16A 250V~, type VQ12
 - KS build-in child protection – shuttered live contacts



КОНТАКТ ШУКО+КАПАК 2P+E 16A 250V~ BV __ XO

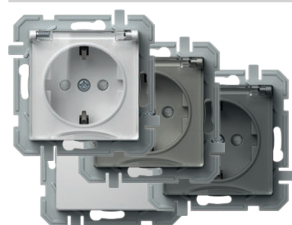

- VQ13PTXO
- VQ13TTXO
- VQ13ATXO
- VQ13PPXO

- BV контакти чрез вкарване 1,5-2,5 mm²
 - XO без панел
 - 2P+E шуко+капак
 - 16A 250V~, тип VQ13
 - KS вградена защита за деца – вградена защита от допир на контакти
- SOCKET SCHUKO+COVER 2P+E 16A 250V~ BV __ XO**
- BV plug-in contacts 1.5-2.5mm²
 - XO without surround
 - 2P+E schuko+cover
 - 16A 250V~, type VQ13
 - KS build-in child protection – shuttered live contacts



КОНТАКТ ШУКО ДВОЕН 2P+E 16A 250V~



- VQ16PW
- VQ16TI
- VQ16AT

- 2P+E шуко двоен
 - 16A 250V~, тип VQ16
 - в съответствие с IEC 60884-1, CEE7
 - винтови контакти 1,5-2,5 mm²
 - KS вградена защита за деца – вградена защита от допир на контакти
- SOCKET SCHUKO DOUBLE 2P+E 16A 250V~**
- 2P+E schuko double
 - 16A 250V~, type VQ16
 - in accordance with IEC 60884-1, CEE7
 - screw contacts 1.5-2.5 mm²
 - KS build-in child protection – shuttered live contacts

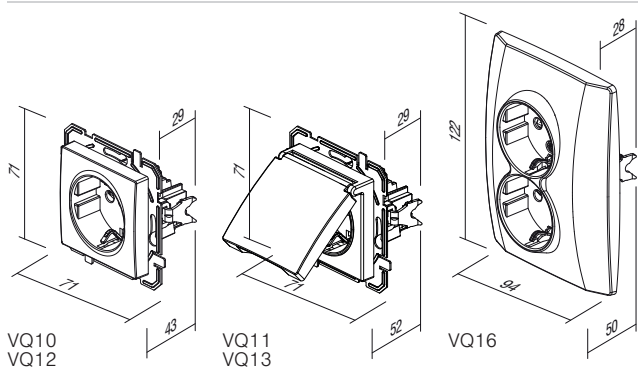

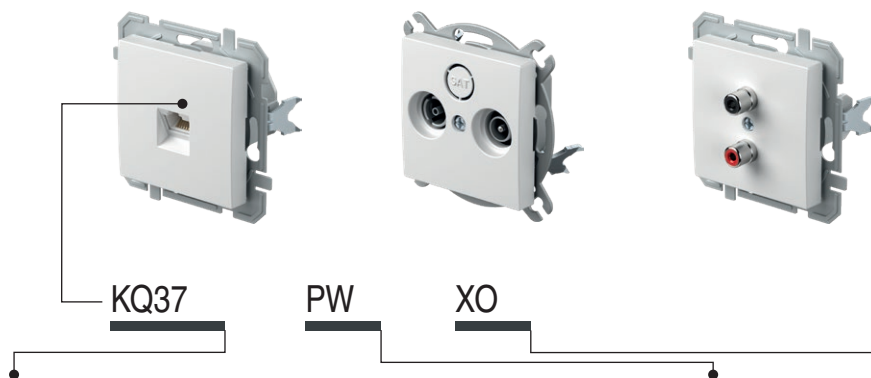

тип type	описание description	технически данни technical data	цвет colour	допълнителна информация 1 optional data 1
KQ11	КОНТАКТ ЗА ТВ-РАДИО КРАЕН SOCKET TV-R END-LINE	1dB	<input type="checkbox"/> PW полярно бяло polar white	XO без декоративен панел without cover plate
KQ12	КОНТАКТ ЗА ТВ-РАДИО ПРЕХОДЕН SOCKET TV-R THROUGHPASS	10dB	<input type="checkbox"/> TI титан titanium	
KQ16	КОНТАКТ ЗА САТЕЛИТНА ТВ-РАДИО КРАЕН SOCKET SAT-TV-R END-LINE	3dB	<input type="checkbox"/> AT антрацит anthracite	
⋮				

КОНТАКТ ЗА ТВ БАЗОВ 0 dB



- KQ10PWXO
- KQ10TIXO
- KQ10ATXO

- контакт за ТВ базов
- затихване 0dB
- заден конектор – стандарт F
SOCKET TV BASIC 0dB
- TV basic
- reduction 0dB
- back connector – F standard



КОНТАКТ ЗА ТВ-РАДИО КРАЕН 1 dB



- KQ11PWXO
- KQ11TIXO
- KQ11ATXO

- за ТВ-радио краен
- честотен обхват 5-862 MHz
- затихване: Радио – 1,5 dB, ТВ – 1 dB
- в съответствие с EN 50083-1
- винтов контакт
SOCKET TV-R END-LINE 1dB
- TV-R end-line
- frequency range 5-862 MHz
- reduction: R-1.5dB, TV-1dB
- in accordance with EN 50083-1
- screw contact



КОНТАКТ ЗА ТВ-РАДИО ПРЕХОДЕН 10 dB



- KQ12PWXO
- KQ12TIXO
- KQ12ATXO

- за ТВ-радио преходен
- честотен обхват 5-862 MHz
- затихване: Радио – 10 dB, ТВ – 10 dB, преход – 2 dB
- в съответствие с EN 50083-1
- винтови контакти
SOCKET TV-R THROUGHPASS 10dB
- TV-R throughpass
- frequency range 5-862 MHz
- reduction: R-10dB, TV-10dB, trough-2dB
- in accordance with EN 50083-1
- screw contacts



КОНТАКТ ЗА САТЕЛИТНА ТВ-РАДИО КРАЕН 3 dB



- KQ16PWXO
- KQ16TIXO
- KQ16ATXO

- за сателитна ТВ-радио краен
- честотен обхват 5-2400 MHz
- затихване: Радио – 1 dB, ТВ – 1,5 dB, сателитна ТВ – 3 dB
- в съответствие с EN 50083-1
- винтови контакти
SOCKET SAT-TV-R END-LINE 3dB
- SAT-TV-R end-line
- frequency range 5-2400 MHz
- reduction: R-1dB, TV-1.5dB, SAT-3dB
- in accordance with EN 50083-1
- screw contacts



КОНТАКТ ЗА АУДИОСИГНАЛИ 2xRCA



- KQ22PWXO
- KQ22TIXO
- KQ22ATXO

- за аудиосигнали 2xRCA
 - свързване на кабела чрез запояване
SOCKET AUDIO 2xRCA
 - audio 2xRCA
 - soldering connection of cable



КОНТАКТ ЗА ВИСОКОГОВОРТЕЛИ



- KQ23PWXO
- KQ23TIXO
- KQ23ATXO

- за аудиосигнали 2x Ø4 mm
 - за проводник за високоговорители, с щепсел тип банан Ø4 mm или плоски конектори
 - свързване на кабела от задната страна чрез запояване
SOCKET AUDIO LOUDSPEAKERS
 - audio 2x Ø4mm
 - to accommodate speaker wire, banana plug Ø4mm or spades
 - soldering connection of cable at the back side



КОНЕКТОР ЗА ТЕЛЕФОН KS RJ11 6/4

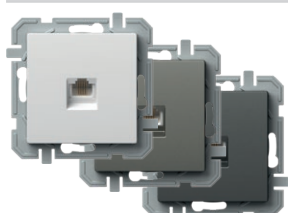

- KQ36PWXO
- KQ36TIXO
- KQ36ATXO

- KS модул стандарт за закрепване
 - RJ11 6/4
 - в съответствие с IEC 60603-7
SOCKET TEL KS RJ11 6/4
 - KS keystone fixing standard
 - RJ11 6/4
 - in accordance with IEC 60603-7



КОНЕКТОР CAT5e KS RJ45 8/8



- KQ37PWXO
- KQ37TIXO
- KQ37ATXO

- KS модул стандарт за закрепване
 - CAT5e, RJ45 8/8
 - в съответствие с IEC 60603-7
SOCKET CAT5e KS RJ45 8/8
 - KS keystone fixing standard
 - CAT5e, RJ45 8/8
 - in accordance with IEC 60603-7



КОНЕКТОР ЗА ТЕЛЕФОН KS ДВОЕН 2x RJ11 6/4



- KQ38PWXO
- KQ38TIXO
- KQ38ATXO

- KS модул стандарт за закрепване
 - 2x RJ11, 6/4
 - в съответствие с IEC 60603-7
SOCKET TEL KS DOUBLE 2x RJ11 6/4
 - KS keystone fixing standard
 - 2x RJ11, 6/4
 - in accordance with IEC 60603-7



КОНЕКТОР CAT5e KS ДВОЕН 2x RJ45 8/8



- KQ39PWXO
- KQ39TIXO
- KQ39ATXO

- KS модул стандарт за закрепване
 - 2x CAT5e, RJ45 8/8
 - в съответствие с IEC 60603-7
SOCKET CAT5e KS DOUBLE 2x RJ45 8/8
 - KS keystone fixing standard
 - 2x CAT5e, RJ45 8/8
 - in accordance with IEC 60603-7



КОНЕКТОР ЗА ТЕЛЕФОН LT RJ11 6/4

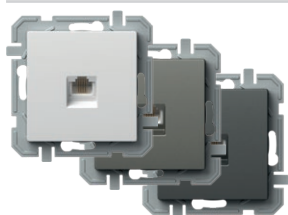

- KQ35PWXO
- KQ35TIXO
- KQ35ATXO

- телефонен LT винтов
 - винтови контакти
 - RJ11 6/4
 - в съответствие с IEC 60603-7
SOCKET TEL LT RJ11 6/4
 - TEL LT screw
 - screw contacts
 - RJ11 6/4
 - in accordance with IEC 60603-7



КОНЕКТОР CAT6s KS RJ45 8/8 SLIM

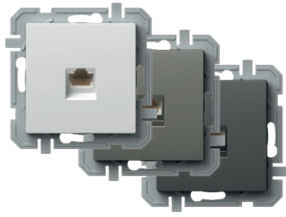

- KQ40PWXO
- KQ40TIXO
- KQ40ATXO

- KS модулен стандарт за закрепване
 - CAT6s, RJ45 8/8
 - в съответствие с IEC 60603-7

SOCKET CAT6s KS RJ45 8/8 SLIM

- KS keystone fixing standard
 - CAT6s, RJ45 8/8
 - in accordance with IEC 60603-7



КОНЕКТОР CAT6s KS ДВОЕН 2x RJ45 8/8 SLIM

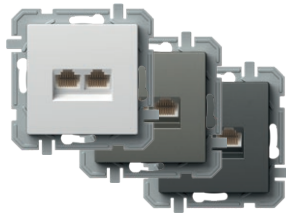

- KQ41PWXO
- KQ41TIXO
- KQ41ATXO

- KS модулен стандарт за закрепване
 - 2x CAT6s, RJ45 8/8
 - в съответствие с IEC 60603-7

SOCKET CAT6s KS DOUBLE 2x RJ45 8/8 SLIM

- KS keystone fixing standard
 - 2x CAT6s, RJ45 8/8
 - in accordance with IEC 60603-7

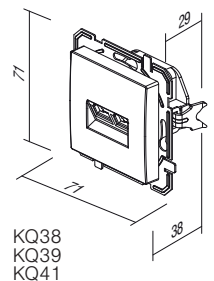
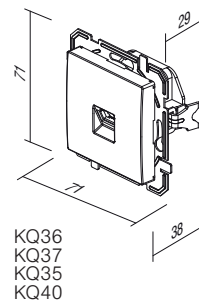
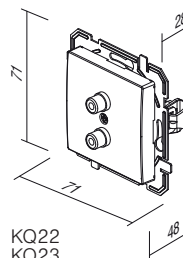
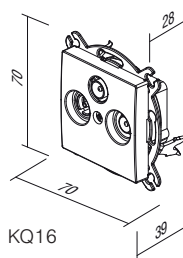
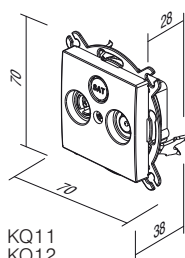
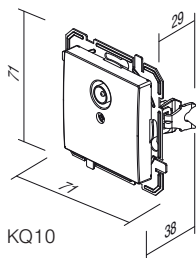



EQ15

PW

XO

тип type	описание description	технически данни technical data	цвет colour	допълнителна информация 1 optional data 1
EQ15	ДИМЕР, ВЪРТЯЩ ТИП, ДВУПОСОЧЕН DIMMER ROTATIVE 2WAY	RL 400W	<input type="checkbox"/> PW полярно бяло polar white	XO без декоративен панел without cover plate
EQ16	ДИМЕР, ВЪРТЯЩ ТИП, ДВУПОСОЧЕН DIMMER ROTATIVE 2WAY	RLC 400W	<input type="checkbox"/> TI титан titanium	
EQ19	ДИМЕР, ВЪРТЯЩ ТИП, ДВУПОСОЧЕН DIMMER ROTATIVE 2WAY	LED 100W	<input type="checkbox"/> AT антрацит anthracite	
...

**ДИМЕР, ВЪРТЯЩ ТИП, ДВУПОСОЧЕН,
АКТИВЕН/ИНДУКТИВЕН ТОВАР 400 W**



- EQ15PWXO
- EQ15TIXO
- EQ15ATXO

- управление чрез завъртане, с двупосочен ключ
- активен/индуктивен товар, 40 W - 400 W
- възможна е комбинация с двупосочен ключ
- не се допуска комбинация с допълнителни димери
- в съответствие с EN 60669-1 and EN 60669-2-1
- контакти чрез вкарване на проводниците 1,5 mm²
- захранващо напрежение 230 V~ 50 Hz
- предпазител за смяна е включен в доставката



DIMMER ROTATIVE 2WAY RL 400W

- rotation control with 2-way switch
- load RL, 40W - 400W
- 2-way switch combination is possible
- more dimmers combination is not allowed
- in accordance with EN 60669-1 and EN 60669-2-1
- plug-in contacts 1.5mm²
- supply 230V~ 50Hz
- replaceable fuse included

**ДИМЕР, ВЪРТЯЩ ТИП, ДВУПОСОЧЕН,
АКТИВЕН/ИНДУКТИВЕН/КАПАЦИТИВЕН ТОВАР 400 W**



- EQ16PWXO
- EQ16TIXO
- EQ16ATXO

- управление чрез завъртане, с двупосочен ключ
- активен/индуктивен/капацитивен товар, 20 W - 400 W
- възможна е комбинация с двупосочен ключ
- не се допуска комбинация с допълнителни димери
- в съответствие с EN 60669-1 and EN 60669-2-1
- контакти чрез вкарване на проводниците 1,5 mm²
- захранващо напрежение 230 V~ 50 Hz
- електронен предпазител



DIMMER ROTATIVE 2WAY RLC 400W

- rotation control with 2-way switch
- load RLC, 20W - 400W
- 2-way switch combination is possible
- more dimmers combination is not allowed
- in accordance with EN 60669-1 and EN 60669-2-1
- plug-in contacts 1.5mm²
- supply 230V~ 50Hz
- electronic fuse

**ДИМЕР, ВЪРТЯЩ ТИП, ДВУПОСОЧЕН, ЗА
СВЕТОДИОДНО ОСВЕТЛЕНИЕ 100 W**



- EQ19PWXO
- EQ19TIXO
- EQ19ATXO

- управление чрез завъртане, с двупосочен ключ
- това: светодиодно осветление, 0-100 W
(макс. 10 светодиода)
- GLS, 10-250 W
- възможна е комбинация с двупосочен ключ
- не се допуска комбинация с допълнителни димери
- в съответствие с EN 60669-1 and EN 60669-2-1
- контакти чрез вкарване на проводниците 1,5 mm²
- захранващо напрежение 230 V~ 50 Hz
- предпазител за смяна е включен в доставката



DIMMER ROTATIVE 2WAY LED 100W

- rotation control with 2-way switch
- load: LED, 0-100W (max. 10 LEDs)
- GLS, 10-250W
- 2-way switch combination is possible
- more dimmers combination is not allowed
- in accordance with EN 60669-1 and EN 60669-2-1
- plug-in contacts 1.5mm²
- supply 230V~ 50Hz
- replaceable fuse included

EQ15, EQ16, EQ19

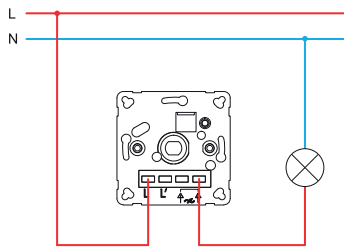

EQ15, EQ16, EQ19

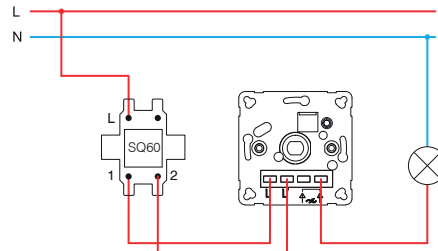

EQ15, EQ16, EQ19

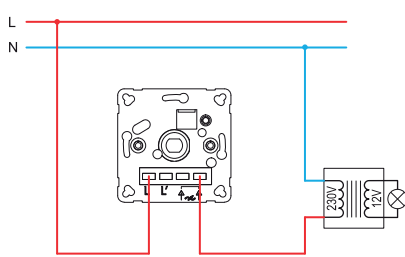

EQ15, EQ16, EQ19

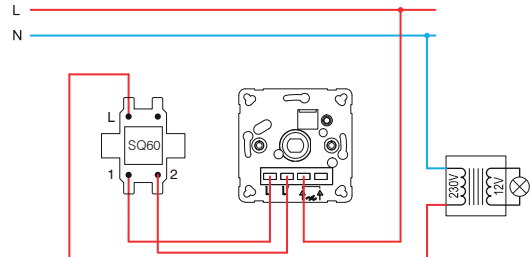

EQ16, EQ19

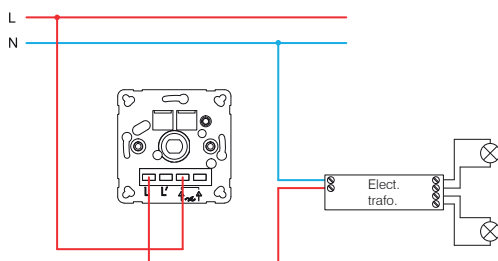

EQ16, EQ19

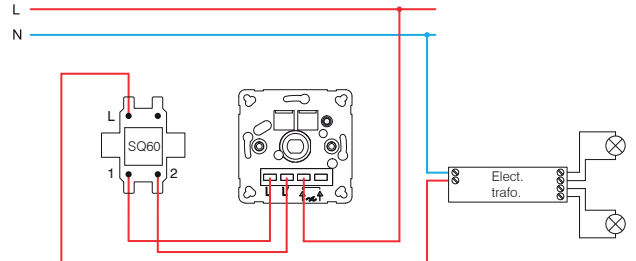
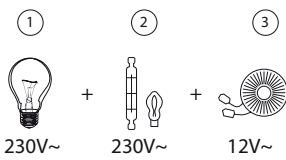
**EQ15 (40÷400W)**

- 1 - лампа с нажежаема жичка
incandescent lamp
2 - халогенна лампа
halogen lamp

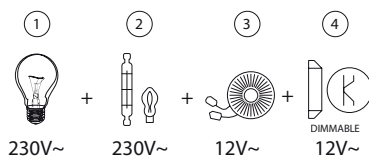
EQ16 (20÷400W)

- 3 - класически трансформатор
classical transformer
4 - димиращ електронен трансформатор
dimnable electronic transformer

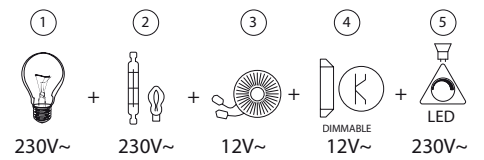
EQ19 (GLS 10÷250W ; LED 0÷100W)

- 5 - димируема светодиодна лампа
dimnable LED lamp

ИЧ КЛЮЧ 5A 230V~



- EQ32PWXO
- EQ32TIXO
- EQ32ATXO

- инфрачервен ключ IR
- захранващо напрежение: 230V~ ±10% 50 Hz
- реле: 5A / 250V~ изход за ограничен ток с висока устойчивост за нулевата стойност
- клас на защита: IP40
- сечение на проводниците при контакта: 0,75 - 2,5 mm²
- ъгъл на откриване: до 110° при 20°C
- разстояние на откриване: прикл. 8 m при 20°C
- регулируема продължителност: от прикл. 5 сек до 12 мин
- регулиране на яркостта на осветлението: от прикл. 5 до 200 лукса
- работна температура: от 0°C до +40°C
- не е подходящо за инсталиране в конзоли с дълбочина 45 mm
- само за употреба на закрито

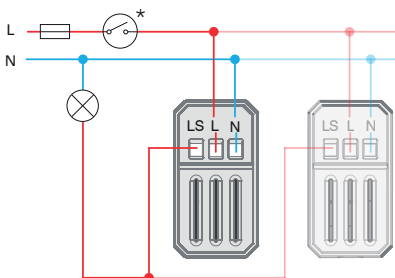

IR SWITCH 5A 230V~

- IR infrared switch
- supply voltage: 230V~ ±10 % 50Hz
- relay: 5A / 250V~ output for limited current with high resistance for zero crossing
- protection rating: IP40
- cross-section of wires at the contact terminal: 0.75 - 2.5 mm²
- detection angle: up to 110° at 20°C
- detection area: approx. 8 m at 20°C
- adjustability of duration: from approx. 5 s to 12 min
- adjustability of brightness: from approx. 5 to 200 LUX
- operating temperature: from 0°C to +40°C
- not suitable for installation in 45 mm deep boxes
- only for indoor usage

ОТОПЛЕНИЕ С ТЕРМОСТАТ 10A 230V~

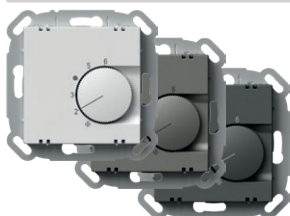

- EQ35PWXO
- EQ35TIXO
- EQ35ATXO

- работен режим: отопление
- захранване: 230 V~, 50 Hz
- изход: 4 A (макс. 10 A), 230 V~, 50 Hz
- комутационен контактор: NC (макс. 10 устройства)
- обхват на регулиране: +5°C до +30°C
- хистерезис: 0,5 K
- защита: IP30
- тип датчик: биметален
- тип електрическа връзка: пружинно натоварени контакти
- типове проводници: 0,75 – 1,5 mm² (гъвкаво-вплетена основа) или 1,0 – 2,5 mm² (солидна основа)

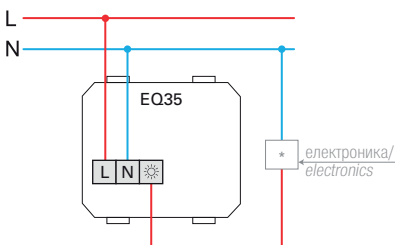

THERMOSTAT HEATING 10A 230V~

- operation mode: heating
- power supply: 230 V~, 50 Hz
- output: 4 A (max. 10 A), 230 V~, 50 Hz
- switching contact: NC (max. 10 actuators)
- regulation range: +5 °C to +30 °C
- hysteresis: 0,5 K
- protection: IP30
- sensor type: bimetal
- type of electrical connection: spring-loaded contacts
- type of conductors: 0,75 – 1,5mm² (flexible-stranded core) or 1,0 – 2,5 mm² (solid core)

ОТОПЛЕНИЕ/ОХЛАЖДАНЕ С ТЕРМОСТАТ 5A 230V~

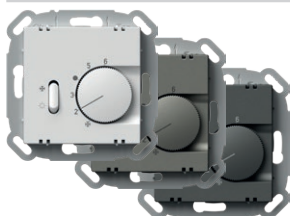

- EQ36PWXO
- EQ36TIXO
- EQ36ATXO

- работен режим: отопление/охлаждане
- захранване: 230 V~, 50 Hz
- изход: 2 A (макс. 5 A), 230 V~, 50 Hz
- комутационен контактор: превключващ ключ (превключвател, макс. 5 устройства)
- обхват на регулиране: +5°C до +30°C
- хистерезис: 0,5 K
- защита: IP30
- тип датчик: биметален
- тип електрическа връзка: пружинно натоварени контакти
- типове проводници: 0,75 – 1,5 mm² (гъвкаво-вплетена основа) или 1,0 – 2,5 mm² (солидна основа)

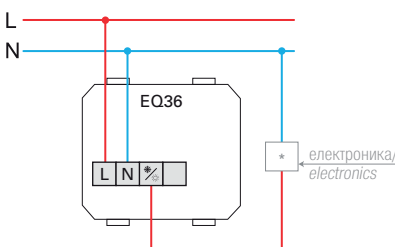

THERMOSTAT HEATING / COOLING 5A 230V~

- operation mode: heating / cooling
- power supply: 230 V~, 50 Hz
- output: 2 A (max. 5 A), 230 V~, 50 Hz
- switching contact: changeover switch (toggler, max. 5 actuators)
- regulation range: +5 °C to +30 °C
- hysteresis: 0,5 K
- protection: IP30
- sensor type: bimetal
- type of electrical connection: spring-loaded contacts
- type of conductors: 0,75 – 1,5mm² (flexible-stranded core) or 1,0 – 2,5 mm² (solid core)

ПОДОВО ОТОПЛЕНИЕ С ТЕРМОСТАТ 16A 230V~



- EQ37PWXO
- EQ37TIXO
- EQ37ATXO

- работен режим: подово отопление
- захранване: 230 V~, 50 Hz
- изход: 2 A (макс. 16 A), 230 V~, 50 Hz
- обхват на регулиране: +10 °C до +50 °C
- хистерезис: 1 K
- защита: IP30
- тип датчик: NTC в съответствие с DIN EN 60730-2-1
- индикатори: Червен светодиод за отопление и зелен светодиод за режим на намаляване през нощта
- тип електрическа връзка: Винтови контакти
- типове проводници: 0,5 - 2,5 mm²

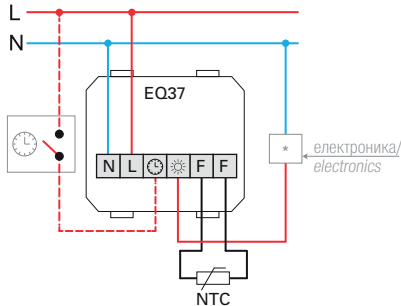

THERMOSTAT FLOOR HEATING 16A 230V~

- operation mode: floor heating
- power supply: 230 V~, 50 Hz
- output: 2 A (max. 16 A), 230 V~, 50 Hz
- regulation range: +10 °C to +50 °C
- hysteresis: 1 K
- protection: IP30
- sensor type: NTC in compliance with DIN EN 60730-2-1
- indicators: Red LED for heating and green LED for night decrease mode
- type of electrical connection: Screw contacts
- type of conductors: 0,5 - 2,5mm²

USB ЗАХРАНВАЩ БЛОК 5 V 3,0 A



- EQ68PW
- EQ68TI
- EQ68AT

- за зареждане на електронни устройства чрез стандартен USB порт (съвместим и с устройства на Apple)
- захранване: 100-230 V~ 50/60 Hz
- консумация на енергия: 300mA при 100V~/150mA при 230V~
- консумация на енергия в режим на готовност: 30mW при 230V~
- номинално изходно напрежение: 5 VCD (± 5%) SELV
- изходно напрежение на пулсации: 150 mV
- номинален изходен ток: 3.0 A (±10%)
- вид конектор: USB A/USB C
- ефективност: максимум 77%
- температура на работа: 0 °C/+45 °C (за употреба в затворени пространства)
- Клас на IP защита: IP20, само за употреба в затворени пространства
- устройство клас II
- категория свръхнапрежение (EN 62109): Клас III
- винтови контакти: макс. 2,5 mm²
- устройство с контактна междина най-малко 3 mm
- в съответствие с Директива EN 60950-1 и Директива за безопасност на нисковолтови електрически съоръжения (LVD) и Директива относно електромагнитна съвместимост (EMC)



USB POWER SUPPLY UNIT 5V 3.0A

- for charging electronic devices via a standard USB port (also compatible with Apple devices)
- power supply: 100-230V~ 50/60Hz
- power consumption: 300mA at 100V~/150mA at 230V~
- standby power consumption: 30mW at 230V~
- nominal output voltage: 5 VCD (± 5%) SELV
- output ripple voltage: 150mV
- nominal output current: 3.0 A (±10%)
- connector type: USB A / USB C
- efficiency: maximum of 77%
- operating temperature: 0 °C/+45 °C (indoor use)
- IP protection class: IP20, indoor use only
- class device II
- overvoltage category (EN 62109): Class III
- screw contacts: max. 2.5 mm²
- device with a contact gap of at least 3mm
- in accordance with the EN 60950-1 and LVD & EMC directives

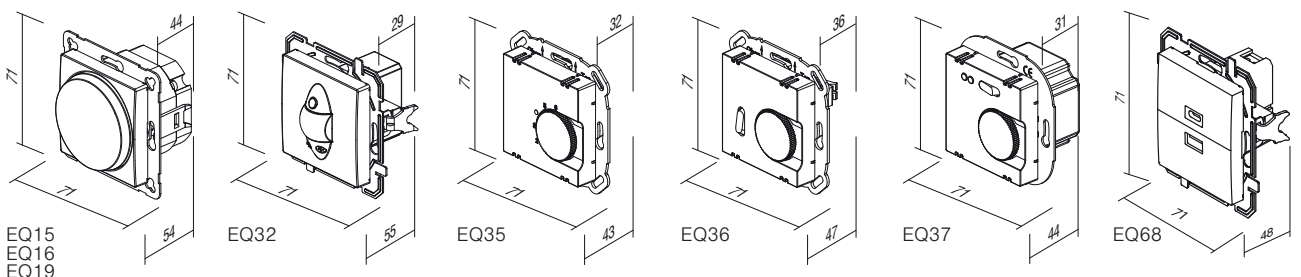

EQ15
EQ16
EQ19

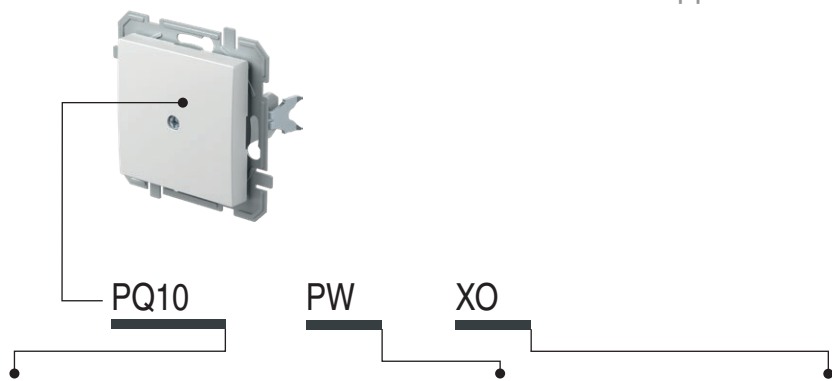

тип type	описание description	цвет colour	допълнителна информация 1 optional data 1
PQ10	КАПАЧЕ BLANK	<input type="checkbox"/> PW полярно бяло polar white	XO без декоративен панел without cover plate
PQ30	ПАНЕЛ TAE/TDO COVER TAE/TDO	<input type="checkbox"/> TI титан titanium <input checked="" type="checkbox"/> AT антрацит anthracite	

КАПАЧЕ



- PQ10PWXO
- PQ10TIXO
- PQ10ATXO

- за запълване на празни позиции
BLANK
- for filling up empty spaces



ПАНЕЛ TAE/TDO

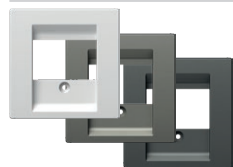

- PQ30PW
- PQ30TI
- PQ30AT

- TAE или TDO панел с винт
COVER TAE/TDO
- TAE or TDO cover with screw

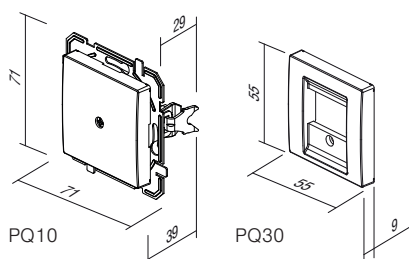

C O V E R P L A T E S O Q

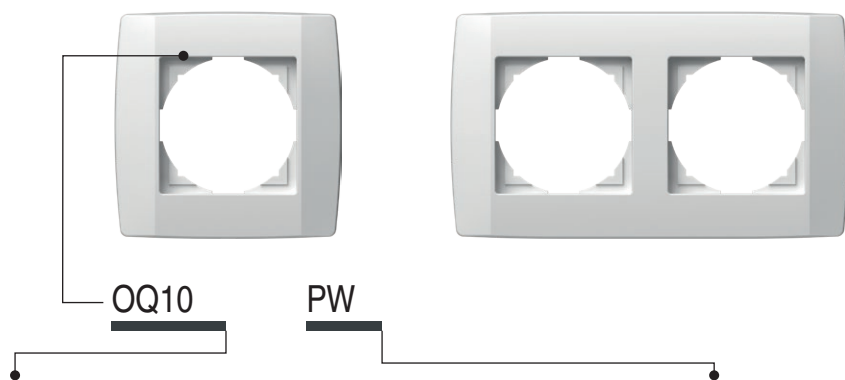

тип type	описание description	цвет colour
OQ10	ПАНЕЛ LOGIQ 1 COVER PLATE LOGIQ 1	PW полярно бяло polar white
OQ20	ПАНЕЛ LOGIQ 2 COVER PLATE LOGIQ 2	TI титан titanium
OQ30	ПАНЕЛ LOGIQ 3 COVER PLATE LOGIQ 3	AT антрацит anthracite
:	:	:



OQ10PW
 OQ10TI
 OQ10AT

ПАНЕЛ LOGIQ 1

- декоративен панел 1-gang
- в съответствие с EN 60669-1

COVER PLATE LOGIQ 1
- decorative cover plate 1-gang
- in accordance with EN 60669-1

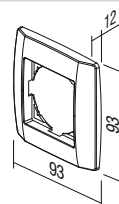

OQ20PW
 OQ20TI
 OQ20AT

ПАНЕЛ LOGIQ 2

- декоративен панел 2-gang
- в съответствие с EN 60669-1

COVER PLATE LOGIQ 2
- decorative cover plate 2-gang
- in accordance with EN 60669-1

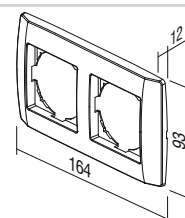

ПАНЕЛ LOGIQ 3



- OQ30PW
- OQ30TI
- OQ30AT

- декоративен панел 3-gang
- в съответствие с EN 60669-1

COVER PLATE LOGIQ 3
- decorative cover plate 3-gang
- in accordance with EN 60669-1

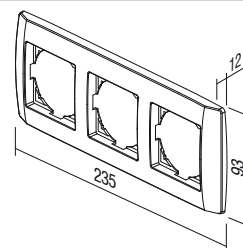

ПАНЕЛ LOGIQ 4



- OQ40PW
- OQ40TI
- OQ40AT

- декоративен панел 4-gang
- в съответствие с EN 60669-1

COVER PLATE LOGIQ 4
- decorative cover plate 4-gang
- in accordance with EN 60669-1

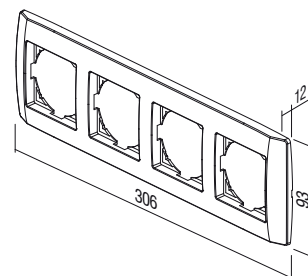

ПАНЕЛ LOGIQ 5



- OQ50PW
- OQ50TI
- OQ50AT

- декоративен панел 5-gang
- в съответствие с EN 60669-1

COVER PLATE LOGIQ 5
- decorative cover plate 5-gang
- in accordance with EN 60669-1

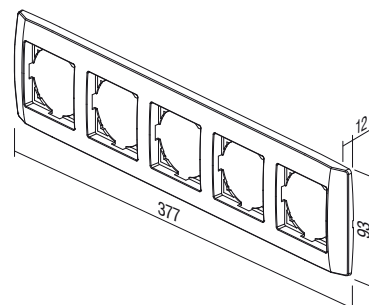

TEM

ekonomik





ekonomik

ПЛАНИРАНИ ЗА ПОСТИГАНЕ НА СЪВЪРШЕНСТВО **Стилът е важен**

Неутрален, компактен, елегантен стил, който се вписва във всяка работна или жилищна зона. В интериора нищо не се набива в очи, а по-скоро хармонично му пасва.

PLANNED FOR EXCELLENCE **Style is essential**

A neutral, compact, elegant design is adjustable to every working or living area. It does not stick out from the interior, but rather harmonically fits into it.





ekonomik

ХАРМОНИЯ НА ЦВЕТОВЕТЕ Изберете своя нюанс

Желанията могат да бъдат най-различни. Затова ние внимателно сме подбрали възможности за вас, които може да ви предоставят правилния отговор. Неутрална палитра от цветове само ще допълни вашата среда – а няма да я ограничава.

HARMONY OF COLOURS Choose your hue

Desires can be very different. Therefore we have carefully selected possibilities for you, which can offer you the right answer. A neutral palette of colours will only complement your ambient - it will not restrict it.

- | | | |
|-----------------------------|--------------------------|------------------------|
| <input type="checkbox"/> PW | полярно бяло | <i>polar white</i> |
| <input type="checkbox"/> IW | слонова кост | <i>ivory white</i> |
| <input type="checkbox"/> ES | елоксирано сребро | <i>elox silver</i> |
| <input type="checkbox"/> CO | термоактивно бяло | <i>white thermoset</i> |
| <input type="checkbox"/> NB | нощно черно | <i>night black</i> |



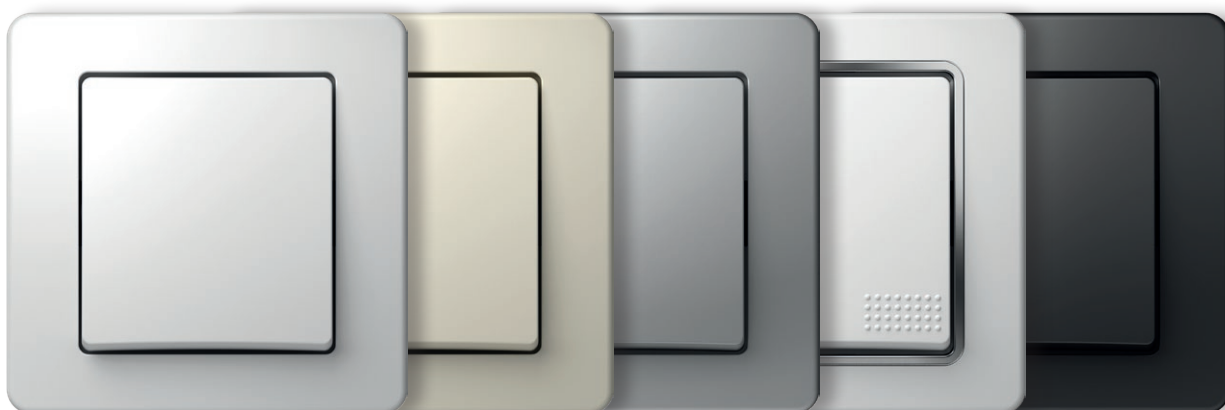

ОПТОСТЕНО ЗА НАЙ-ВЗИСКАТЕЛНИТЕ

Чрез грижливо планиране елементите под напрежение са защитени срещу докосване. Основното закрепване на механизмите чрез закрепващи крачета (1) дава възможност за допълнително заздравяване с винтове (2). Този начин е особено подходящ за безопасно и надеждно закрепване на контакти.

SIMPLE FOR THE MOST DEMANDING

By careful planning elements under voltage have been protected against touching. Basic fixing of mechanisms with fixing claws (1) allows additional strengthening with screws (2). This manner is especially appropriate for safe and reliable fixing of sockets.

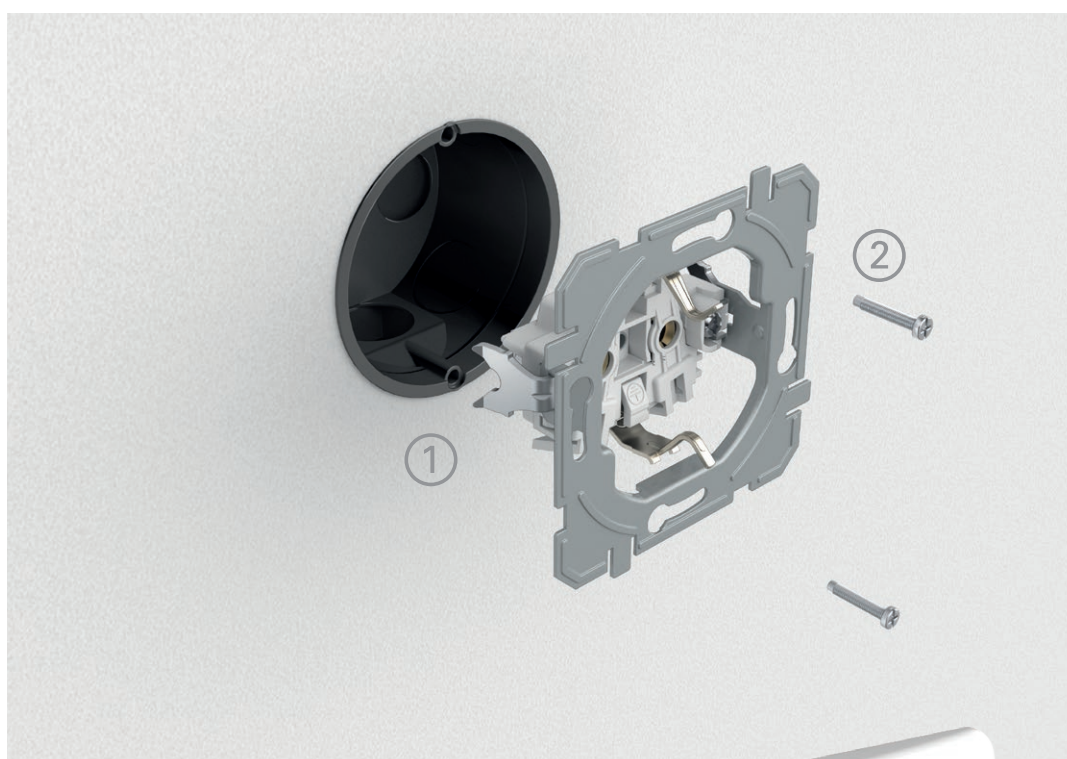

КОМБИНИРАЙТЕ КАКТО ВИ СЕ ИСКА.
COMBINE AS YOU PLEASE.

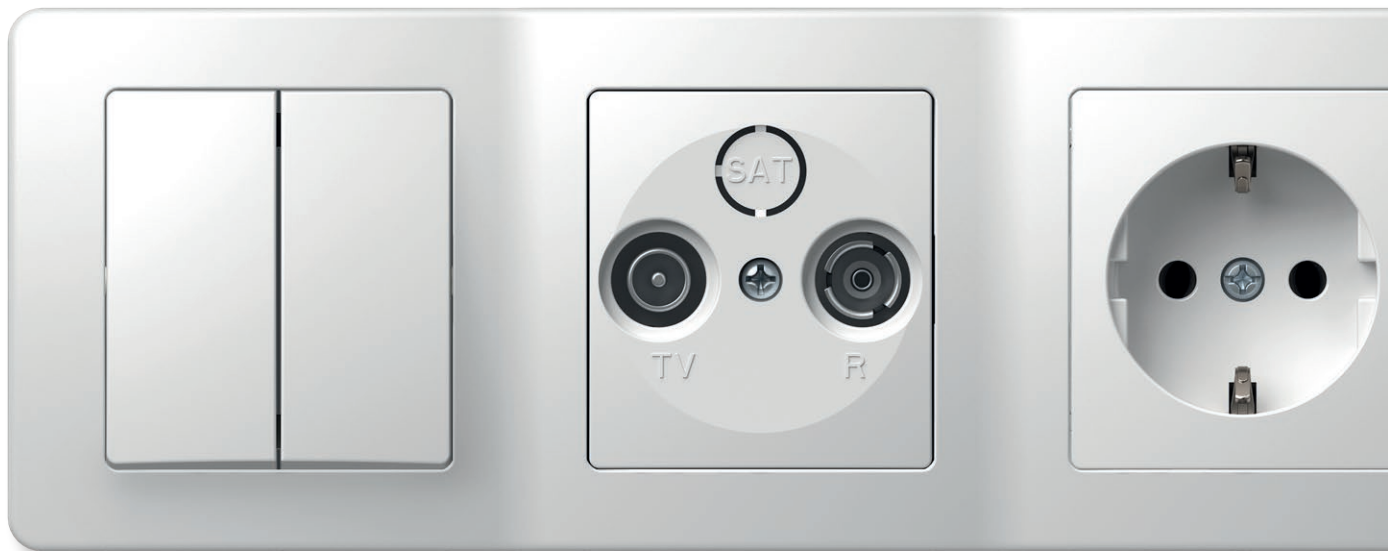

Комбинирайки, вие икономисвате място върху стената. Когато се сблъсквате с ограничено място, »вертикално« е правилното решение.

With combining you save space on the wall. When faced with a limited space, »vertically« is the right decision.

ЛЕСЕН МОНТАЖ

Економик е решение за системата от стандартизирани кръгли инсталационни кутии. Може да се използва както за прости, така и за по-взискателни инсталации, нови сгради и приспособления. Системата се характеризира с контакти чрез вкарване, които спестяват време при монтажа на елементите.

EASY INSTALLATION

Ekonomik is a solution for the system of standardized round installations boxes. It can be used for simple as well as more demanding installations, new buildings and adaptations. The system is characterised by plug-in contacts which save time during installation of elements.

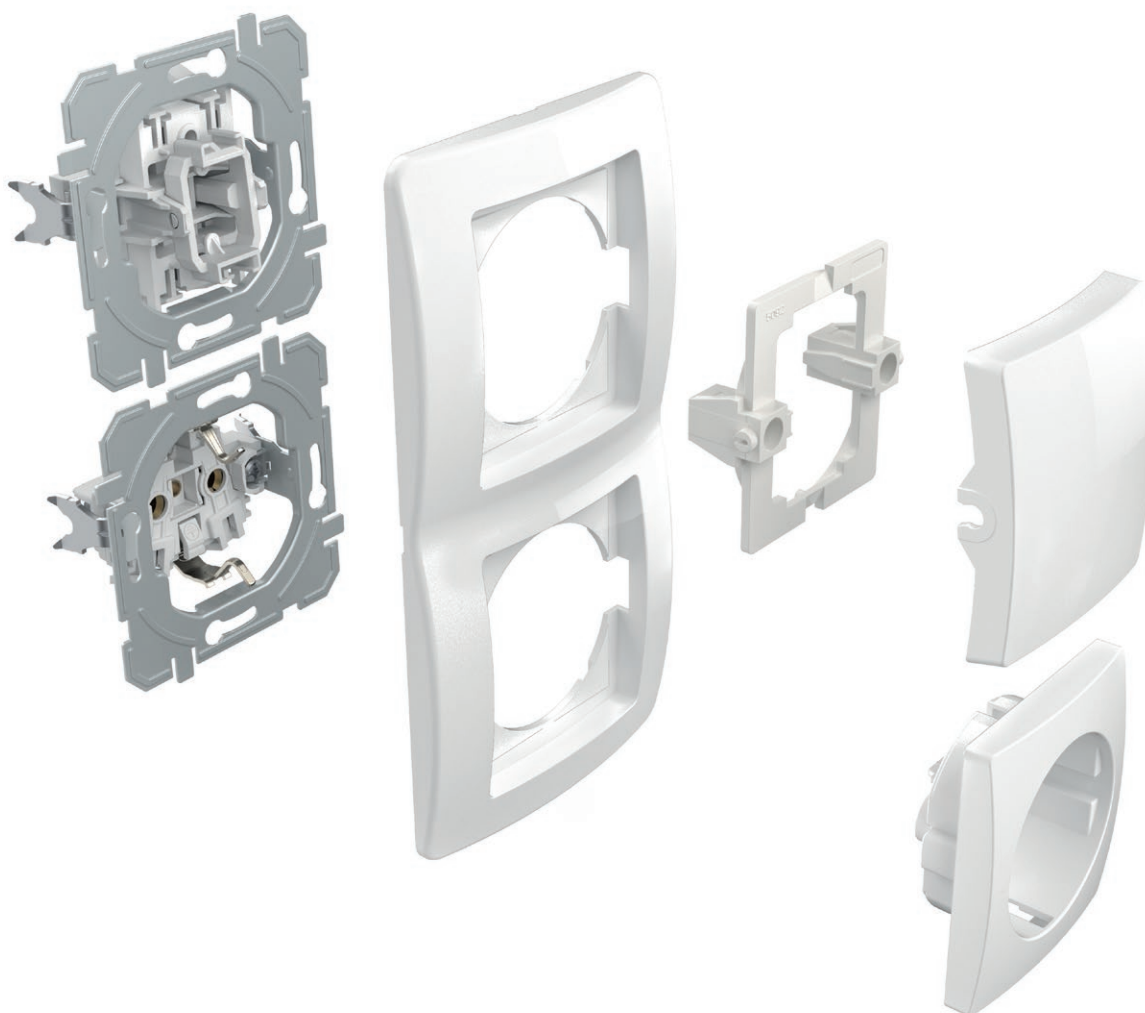

ДОБРЕ Е ДА ЗНАЕТЕ

GOOD TO KNOW



Всички контакти са оборудвани за безопасно изключване, което гарантира защитата на контактите, които са под напрежение.

All the sockets are equipped with a safety shutters assuring the protection to live contacts.



Добре планирана конструкция на ключа дава възможност лесното осветление да бъде свързано и последователно.

A well-planned switch construction makes easy illumination possible also subsequently.



Контактите, изработени от сребърна сплав, гарантират безопасно включване.

Contacts made of silver alloy guarantee safe switching.



Контактите, осъществявани чрез вкарване на проводниците, позволява бързо и надеждно закрепване на проводниците. Два проводника с различни диаметри може да се свържат към един и същи контакт.

Plug-in contacts enable quick and reliable attachment of wires. Two wires of different diameters can be attached to the same contact.



Закрепващите крачета дават възможност за по-дълбоко закрепване (също така и през керамични плочки и подобни)







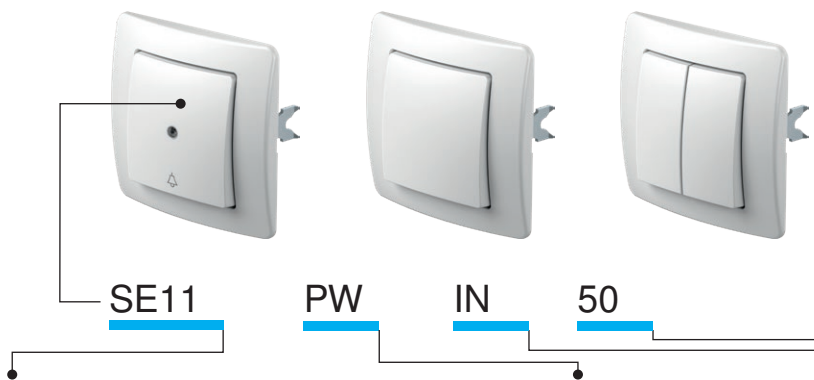

Fixing claws enable deeper fixing (also through ceramic tiles, etc.)



Лесните за монтиране инсталационни конзоли ще улеснят работата ви. Правилните дължини са гарантирани.

Easy-fitting installation boxes will make your work easier. Proper lengths are guaranteed.



тип type	описание description	технически данни technical data	цвет colour	допълнителна информация 1 optional data 1	допълнителна информация 2 optional data 2
SE10	КЛЮЧ 1WAY SWITCH 1WAY	10AX 250V~	<input type="checkbox"/> PW снежнобял polar white	 NT неутрален neutral	 50
SE11	БУТОН 1WAY PUSH BUTTON 1WAY	10A 250V~	<input type="checkbox"/> IW слонова кост ivory white		 51
SE22	КЛЮЧ 2POLE SWITCH 2POLE	16AX 250V~	<input type="checkbox"/> ES сребрист elox silver <input type="checkbox"/> CO бял с термореактивен material white thermoset	 IN индикатор indicator	 03  04
...	<input type="checkbox"/> NB тъмночерен night black		 04 ...

КЛЮЧ 1WAY 10AX 250V~

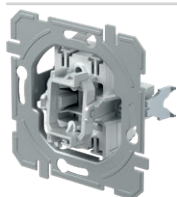

SE10

- 10AX 250V~, тип SE10
- в съответствие с EN 60669-1
- контакти чрез вкарване 1,5 - 2,5 mm²



SWITCH 1WAY 10AX 250V~

- 10AX 250V~, type SE10
- in accordance with EN 60669-1
- plug-in contacts 1.5-2.5mm²

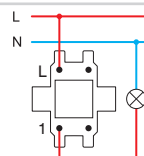

БУТОН 1WAY 10A 250V~

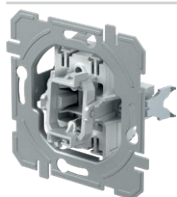

SE11

- 10A 250V~, тип SE11
- в съответствие с EN 60669-1
- контакти чрез вкарване 1,5 - 2,5 mm²



PUSH BUTTON 1WAY 10A 250V~

- 10A 250V~, type SE11
- in accordance with EN 60669-1
- plug-in contacts 1.5-2.5mm²

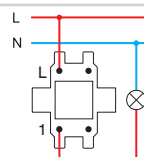

КЛЮЧ 2POLE 16AX 250V~

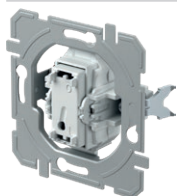

SE22

- 16AX 250V~, тип SE22
- в съответствие с EN 60669-1
- винтови контакти 1,5 - 2,5 mm²
- само в комбинация с бутон TE10__NT03

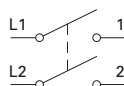

SWITCH 2POLE 16AX 250V~

- 16AX 250V~, type SE22
- in accordance with EN 60669-1
- screw contacts 1.5-2.5mm²
- only in combination with button TE10__NT03

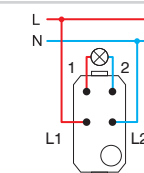

КЛЮЧ 2GANG-1WAY 10AX 250V~

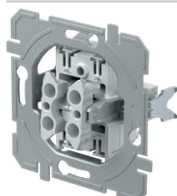

SE50

- 10AX 250V~, тип SE50
- в съответствие с EN 60669-1
- контакти чрез вкарване 1,5 - 2,5 mm²

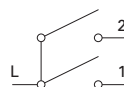

SWITCH 2GANG-1WAY 10AX 250V~

- 10AX 250V~, type SE50
- in accordance with EN 60669-1
- plug-in contacts 1.5-2.5mm²

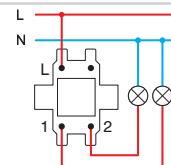

БУТОН 2GANG-1WAY 10A 250V~

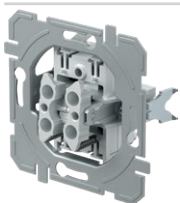

SE51

- 10 A 250 V~, тип SE51
- в съответствие с EN 60669-1
- контакти чрез вкарване 1,5 - 2,5 mm²

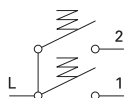

PUSH BUTTON 2GANG-1WAY 10A 250V~

- 10A 250V~, type SE51
- in accordance with EN 60669-1
- plug-in contacts 1.5-2.5mm²

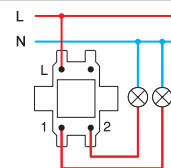

КЛЮЧ ЗА ЩОРИ 10AX 250V~

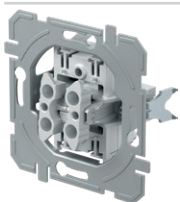

SE52

- 10AX 250 V~, тип SE52
- в съответствие с EN 60669-1
- контакти чрез вкарване 1,5 - 2,5 mm²
- с механична блокировка

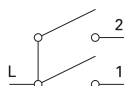

SWITCH SHUTTERS 10AX 250V~

- 10AX 250V~, type SE52
- in accordance with EN 60669-1
- plug-in contacts 1.5-2.5mm²
- with mechanical interblock

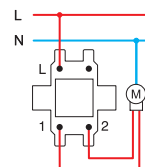

БУТОН ЗА ЩОРИ 10A 250V~

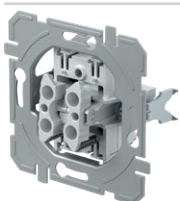

SE53

- 10A 250V~, тип SE53
- в съответствие с EN 60669-1
- контакти чрез вкарване 1,5 - 2,5 mm²
- с механична блокировка

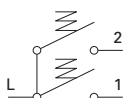

PUSH BUTTON SHUTTERS 10A 250V~

- 10A 250V~, type SE53
- in accordance with EN 60669-1
- plug-in contacts 1.5-2.5mm²
- with mechanical interblock

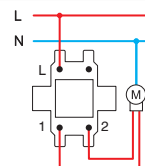

КЛЮЧ 2WAY 10AX 250V~

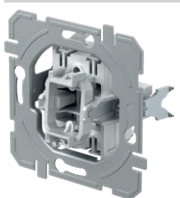

SE60

- 10AX 250V~, тип SE60
- в съответствие с EN 60669-1
- контакти чрез вкарване 1,5 - 2,5 mm²

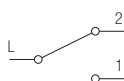

SWITCH 2WAY 10AX 250V~

- 10AX 250V~, type SE60
- in accordance with EN 60669-1
- plug-in contacts 1.5-2.5mm²

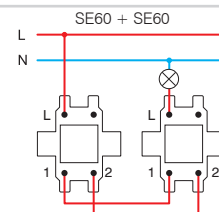

ДВОЕН КЛЮЧ 2WAY 10AX 250V~

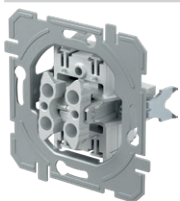

SE63

- 10AX 250V~, тип SE63
- в съответствие с EN 60669-1
- контакти чрез вкарване 1,5 - 2,5 mm²



SWITCH DOUBLE 2WAY 10AX 250V~

- 10AX 250V~, type SE63
- in accordance with EN 60669-1
- plug-in contacts 1.5-2.5mm²

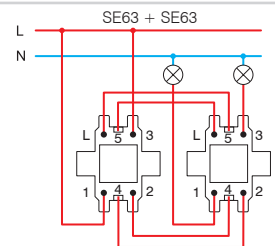

КРЪСТАТ КЛЮЧ 10AX 250V~

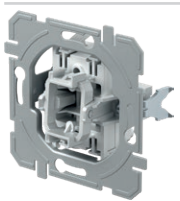

SE70

- 10AX 250V~, тип SE70
- в съответствие с EN 60669-1
- контакти чрез вкарване 1,5 - 2,5 mm²



SWITCH INTERMEDIATE 10AX 250V~

- 10AX 250V~, type SE70
- in accordance with EN 60669-1
- plug-in contacts 1.5-2.5mm²

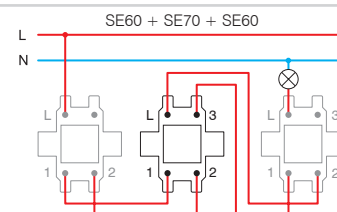



- SE10PW
- SE10IW
- SE10ES
- SE10CO
- SE10NB

КЛЮЧ 1WAY 10AX 250V~

- 10AX 250V~, тип SE10
- в съответствие с EN 60669-1
- контакти чрез вкарване 1,5 - 2,5 mm²

SWITCH 1WAY 10AX 250V~
 - 10AX 250V~, type SE10
 - in accordance with EN 60669-1
 - plug-in contacts 1.5-2.5mm²



- SE10PWIN
- SE10IWIN
- SE10ESIN
- SE10COIN
- SE10NBIN

КЛЮЧ 1WAY 10AX 250V~ __ IN

- IN индикатор
- 10AX 250V~, тип SE10
- в съответствие с EN 60669-1
- контакти чрез вкарване 1,5 - 2,5 mm²

SWITCH 1WAY 10AX 250V~ __ IN
 - IN indicator
 - 10AX 250V~, type SE10
 - in accordance with EN 60669-1
 - plug-in contacts 1.5-2.5mm²



- SE11PW
- SE11IW
- SE11ES
- SE11CO
- SE11NB

БУТОН 1WAY 10A 250V~

- 10A 250V~, тип SE11
- в съответствие с EN 60669-1
- контакти чрез вкарване 1,5 - 2,5 mm²

PUSH BUTTON 1WAY 10A 250V~
 - 10A 250V~, type SE11
 - in accordance with EN 60669-1
 - plug-in contacts 1.5-2.5mm²



- SE11PWTI50
- SE11IWTI50
- SE11ESTI50
- SE11COTI50
- SE11NBTI50

БУТОН 1WAY 10A 250V~ __ TI 50

- TI 50 звънчев индикатор+неонова лампа
- 10A 250V~, тип SE11
- в съответствие с EN 60669-1
- контакти чрез вкарване 1,5 - 2,5 mm²

PUSH BUTTON 1WAY 10A 250V~ __ TI 50
 - TI 50 indicator bell+neon lamp
 - 10A 250V~, type SE11
 - in accordance with EN 60669-1
 - plug-in contacts 1.5-2.5mm²



- SE11PWTI51
- SE11IWTI51
- SE11ESTI51
- SE11COTI51
- SE11NBTI51

БУТОН 1WAY 10A 250V~ __ TI 51

- TI 51 светлинен индикатор+неонова лампа
- 10A 250V~, тип SE11
- в съответствие с EN 60669-1
- контакти чрез вкарване 1,5 - 2,5 mm²

PUSH BUTTON 1WAY 10A 250V~ __ TI 51
 - TI 51 indicator light+neon lamp
 - 10A 250V~, type SE11
 - in accordance with EN 60669-1
 - plug-in contacts 1.5-2.5mm²



- SE11PWIL
- SE11IWIL
- SE11ESIL
- SE11COIL
- SE11NBIL

БУТОН 1WAY 10A 250V~ __ IL

- IL панел с надпис
- 10A 250V~, тип SE11
- в съответствие с EN 60669-1
- контакти чрез вкарване 1,5 - 2,5 mm²

PUSH BUTTON 1WAY 10A 250V~ __ IL
 - IL inscription plate
 - 10A 250V~, type SE11
 - in accordance with EN 60669-1
 - plug-in contacts 1.5-2.5mm²



- SE22PWIN03
- SE22IWIN03
- SE22ESIN03
- SE22NBIN03

КЛЮЧ 2POLE 16AX 250V~ __ IN 03

- IN 03 неутрално положение 0-1
- 16AX 250V~, тип SE22
- в съответствие с EN 60669-1
- винтови контакти 1,5 - 2,5 mm²

SWITCH 2POLE 16AX 250V~ __ IN 03
 - IN 03 neutral 0-1
 - 16AX 250V~, type SE22
 - in accordance with EN 60669-1
 - screw contacts 1.5-2.5mm²



S W I T C H E S S E

	<ul style="list-style-type: none"> <input type="checkbox"/> SE50PW <input type="checkbox"/> SE50IW <input type="checkbox"/> SE50ES <input type="checkbox"/> SE50CO <input type="checkbox"/> SE50NB 	<p>КЛЮЧ 2GANG-1WAY 10AX 250V~</p> <ul style="list-style-type: none"> - 10AX 250V~, тип SE50 - в съответствие с EN 60669-1 - контакти чрез вкарване 1,5 - 2,5 mm² <p><i>SWITCH 2GANG-1WAY 10AX 250V~</i></p> <ul style="list-style-type: none"> - 10AX 250V~, type SE50 - in accordance with EN 60669-1 - plug-in contacts 1.5-2.5mm² 	
	<ul style="list-style-type: none"> <input type="checkbox"/> SE51PW <input type="checkbox"/> SE51IW <input type="checkbox"/> SE51ES <input type="checkbox"/> SE51CO <input type="checkbox"/> SE51NB 	<p>БУТОН 2GANG-1WAY 10A 250V~</p> <ul style="list-style-type: none"> - 10 A 250 V~, тип SE51 - в съответствие с EN 60669-1 - контакти чрез вкарване 1,5 - 2,5 mm² <p><i>PUSH BUTTON 2GANG-1WAY 10A 250V~</i></p> <ul style="list-style-type: none"> - 10A 250V~, type SE51 - in accordance with EN 60669-1 - plug-in contacts 1.5-2.5mm² 	
	<ul style="list-style-type: none"> <input type="checkbox"/> SE52PWNT09 <input type="checkbox"/> SE52IWNT09 <input type="checkbox"/> SE52ESNT09 <input type="checkbox"/> SE52CONT09 <input type="checkbox"/> SE52NBNT09 	<p>КЛЮЧ ЗА ЩОРИ 10AX 250V~ __ NT 09</p> <ul style="list-style-type: none"> - NT 09 неутрално положение – нагоре-надолу - 10AX 250 V~, тип SE52 - в съответствие с EN 60669-1 - контакти чрез вкарване 1,5 - 2,5 mm² - с механична блокировка <p><i>SWITCH SHUTTERS 10AX 250V~ __ NT 09</i></p> <ul style="list-style-type: none"> - NT 09 neutral up-down - 10AX 250V~, type SE52 - in accordance with EN 60669-1 - plug-in contacts 1.5-2.5mm² - with mechanical interblock 	
	<ul style="list-style-type: none"> <input type="checkbox"/> SE53PWNT09 <input type="checkbox"/> SE53IWNT09 <input type="checkbox"/> SE53ESNT09 <input type="checkbox"/> SE53CONT09 <input type="checkbox"/> SE53NBNT09 	<p>БУТОНИ ЗА ЩОРИ 10A 250V~ __ NT 09</p> <ul style="list-style-type: none"> - NT 09 неутрално положение – нагоре-надолу - 10 A 250 V~, тип SE53 - в съответствие с EN 60669-1 - контакти чрез вкарване 1,5 - 2,5 mm² - с механична блокировка <p><i>PUSH BUTTON SHUTTERS 10A 250V~ __ NT 09</i></p> <ul style="list-style-type: none"> - NT 09 neutral up-down - 10A 250V~, type SE53 - in accordance with EN 60669-1 - plug-in contacts 1.5-2.5mm² - with mechanical interblock 	
	<ul style="list-style-type: none"> <input type="checkbox"/> SE60PW <input type="checkbox"/> SE60IW <input type="checkbox"/> SE60ES <input type="checkbox"/> SE60CO <input type="checkbox"/> SE60NB 	<p>КЛЮЧ 2WAY 10AX 250V~</p> <ul style="list-style-type: none"> - 10AX 250V~, тип SE60 - в съответствие с EN 60669-1 - контакти чрез вкарване 1,5 - 2,5 mm² <p><i>SWITCH 2WAY 10AX 250V~</i></p> <ul style="list-style-type: none"> - 10AX 250V~, type SE60 - in accordance with EN 60669-1 - plug-in contacts 1.5-2.5mm² 	
	<ul style="list-style-type: none"> <input type="checkbox"/> SE63PW <input type="checkbox"/> SE63IW <input type="checkbox"/> SE63ES <input type="checkbox"/> SE63CO <input type="checkbox"/> SE63NB 	<p>ДВОЕН КЛЮЧ 2WAY 10AX 250V~</p> <ul style="list-style-type: none"> - 10AX 250V~, тип SE63 - в съответствие с EN 60669-1 - контакти чрез вкарване 1,5 - 2,5 mm² <p><i>SWITCH DOUBLE 2WAY 10AX 250V~</i></p> <ul style="list-style-type: none"> - 10AX 250V~, type SE63 - in accordance with EN 60669-1 - plug-in contacts 1.5-2.5mm² 	
	<ul style="list-style-type: none"> <input type="checkbox"/> SE70PW <input type="checkbox"/> SE70IW <input type="checkbox"/> SE70ES <input type="checkbox"/> SE70CO <input type="checkbox"/> SE70NB 	<p>КРЪСТАТ КЛЮЧ 10AX 250V~</p> <ul style="list-style-type: none"> - 10AX 250V~, тип SE70 - в съответствие с EN 60669-1 - контакти чрез вкарване 1,5 - 2,5 mm² <p><i>SWITCH INTERMEDIATE 10AX 250V~</i></p> <ul style="list-style-type: none"> - 10AX 250V~, type SE70 - in accordance with EN 60669-1 - plug-in contacts 1.5-2.5mm² 	

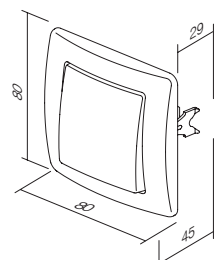
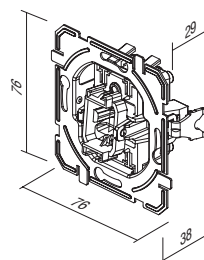



тип type	описание description	цвет colour	допълнителна информация 1 optional data 1	допълнителна информация 2 optional data 2
TE10	БУТОН 1GANG BUTTON 1GANG	<input type="checkbox"/> PW снежнобял цвет polar white	NT с неутрално положение neutral	50
TE11	БУТОН 2GANG BUTTON 2GANG	<input type="checkbox"/> IW слонова кост ivory white	IN индикатор indicator	51
...	...	<input type="checkbox"/> ES сребрист elox silver		03
...	...	<input type="checkbox"/> CO бял с термореактивен материал white thermoset		04
...	...	<input type="checkbox"/> NB тъмночерен night black		

БУТОН 1GANG



- TE10PW
- TE10IW
- TE10ES
- TE10CO
- TE10NB

- бутон заедно с носач
BUTTON 1GANG
- button together with carrier



БУТОН С ИНДИКАТОР

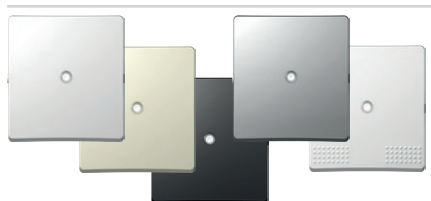

- TE10PWIN
- TE10IWIN
- TE10ESIN
- TE10COIN
- TE10NBIN

- бутон заедно с носач
BUTTON INDICATOR
- button together with carrier



БУТОН С ПАНЕЛ С НАДПИС

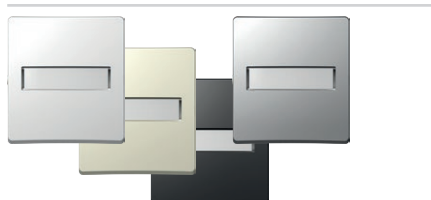

- TE13PWIL
- TE13IWIL
- TE13ESIL
- TE13NBIL

- бутон заедно с носач, с панел с надпис
BUTTON WITH INSCRIPTION PLATE
- button together with carrier, with inscription plate



БУТОН 2GANG



- TE11PW
- TE11IW
- TE11ES
- TE11CO
- TE11NB

- бутон 2gang с носач
BUTTON 2GANG
- button 2gang together with carrier

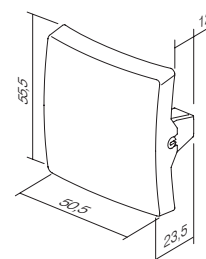
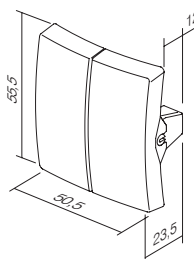

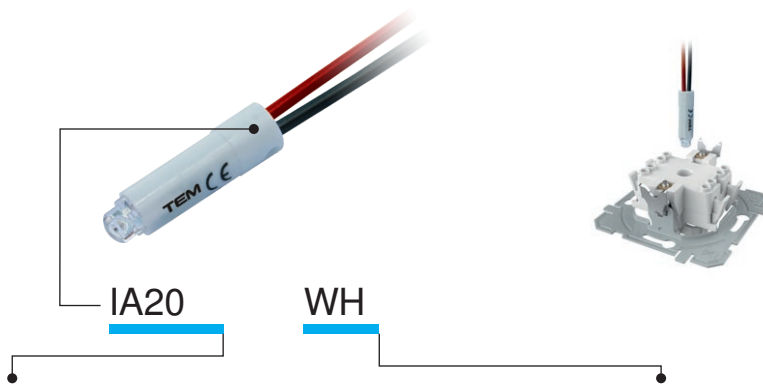

тип type	описание description	технически данни technical data	цвет colour
IA10	НЕОНОВА ЛАМПА NEON LAMP	230V~ 0,34W	<input type="checkbox"/> WH бял цвят white
IA20	СВЕТОДИОДНА ЛАМПА LED LAMP	230V~ 0,40W	<input checked="" type="checkbox"/> BL син цвят blue
IA21	СВЕТОДИОДНА ЛАМПА LED LAMP	24V AC/DC 0,20W	<input checked="" type="checkbox"/> RD червен red
·	·	·	<input checked="" type="checkbox"/> GR зелен green
·	·	·	<input checked="" type="checkbox"/> OR оранжев orange

НЕОНОВА ЛАМПА 230 V~ 0,34 W

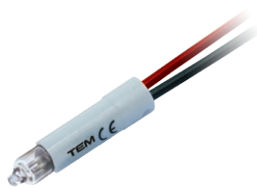

IA10OR

- за индикация, осветление или постоянно осветяване на ключ
- в комбинация с бутон с индикатор

NEON LAMP 230V~ 0,34W

- for indication, illumination or constant illumination of switch
- in combination with button with indicator

СВЕТОДИОДНА ЛАМПА 230 V AC/DC 0,40 W

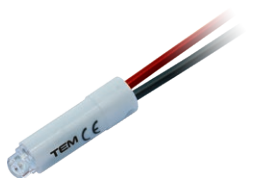

IA20WH
 IA20GR
 IA20RD
 IA20BL

- за индикация, осветление или постоянно осветяване на ключ
- в комбинация с бутон с индикатор

LED LAMP 230V AC/DC 0,40W

- for indication, illumination or constant illumination of switch
- in combination with button with indicator

СВЕТОДИОДНА ЛАМПА 24V AC/DC 0,20W

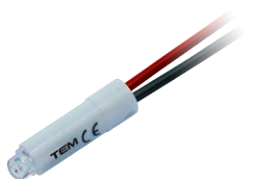

IA21WH
 IA21RD

- за индикация, осветление или постоянно осветяване на ключ
- в комбинация с бутон с индикатор

LED LAMP 24V AC/DC 0,20W

- for indication, illumination or constant illumination of switch
- in combination with button with indicator

СВЕТОДИОДНА ЛАМПА 12V AC/DC 0,10W

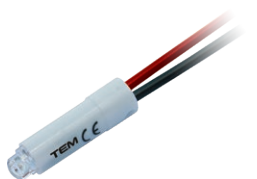

IA22WH
 IA22RD

- за индикация, осветление или постоянно осветяване на ключ
- в комбинация с бутон с индикатор

LED LAMP 12V AC/DC 0,10W

- for indication, illumination or constant illumination of switch
- in combination with button with indicator

Индикация /
Indication

* освещение /
Illumination

Постоянно освещение /
Illumination always on

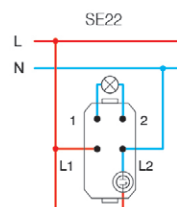
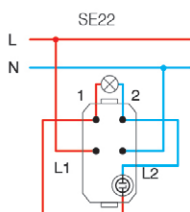
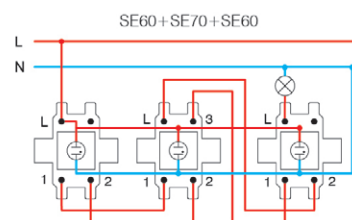
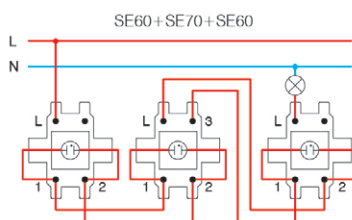
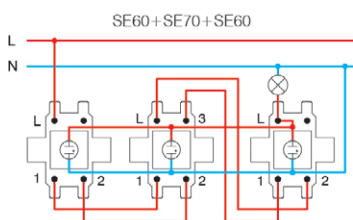
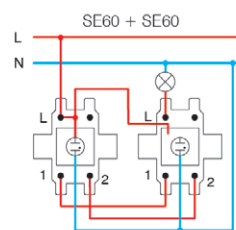
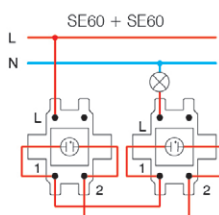
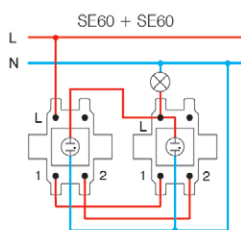
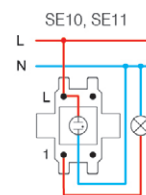
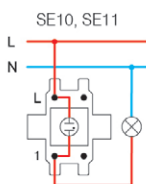
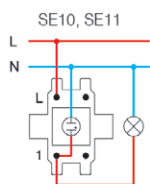

* връзките не са подходящи за енергоспестяващи крушки (CFL, LED) /
the connections are not suitable for energy-saving bulbs (CFL, LED)

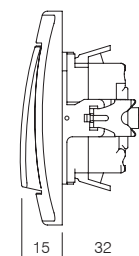

S O C K E T S V E



VE11



PT

XO

KS



тип type	описание description	технически данни technical data	допълнителна информация 1 optional data 1	допълнителна информация 2 optional data 2
VE10	КОНТАКТ ШУКО SOCKET SCHUKO	2P+E 16A 250V~	XO без декоративен панел without cover plate	KS Вградена защита от допир на контакти shuttered live contacts
VE11	КОНТАКТ ШУКО+КАПАК SOCKET SCHUKO+COVER	2P+E 16A 250V~		
VE12	КОНТАКТ ШУКО SOCKET SCHUKO	2P+E 16A 250V~ BV	KS Вградена защита от допир на контакти shuttered live contacts	
⋮	⋮	⋮		

ЦВЯТ
colour

<input type="checkbox"/> PW снежнобял цвят polar white	<input checked="" type="checkbox"/> PT бял + прозрачен white+transparent	<input type="checkbox"/> PP бял + бял white+white
<input type="checkbox"/> IW слонова кост ivory white	<input checked="" type="checkbox"/> IT слонова кост + прозрачен ivory+transparent	<input type="checkbox"/> II слонова кост + слонова кост ivory+ivory
<input type="checkbox"/> ES сребрист elox silver бял с термореактивен материал white thermoset	<input checked="" type="checkbox"/> ST сребрист + прозрачен silver+transparent	<input type="checkbox"/> SS сребрист + сребрист silver+silver
<input type="checkbox"/> CO черен + черен black+black	<input checked="" type="checkbox"/> CT бял + прозрачен white+transparent	<input type="checkbox"/> BB черен + черен black+black
<input checked="" type="checkbox"/> NB тъмночерен night black	<input checked="" type="checkbox"/> BT черен + прозрачен black+transparent	<input type="checkbox"/> RR червен + червен red+red
<input checked="" type="checkbox"/> RD червен red	<input checked="" type="checkbox"/> RT червен + прозрачен red+transparent	<input type="checkbox"/> GG зелен + зелен green+green
<input checked="" type="checkbox"/> GR зелен green	<input checked="" type="checkbox"/> GT зелен + прозрачен green+transparent	<input type="checkbox"/> OO оранжев + оранжев orange+orange
<input checked="" type="checkbox"/> OR оранжев orange	<input checked="" type="checkbox"/> OT оранжев + прозрачен orange+transparent	



Шуко – в съответствие с EN 60884-1, CEE7 (лист със стандарти III)

Френски – в съответствие с NF C 61-314 (лист със стандарти V)

shuko - in accordance with EN 60884-1, CEE7 (standard sheet III)

French - in accordance with NF C 61-314 (standard sheet V)

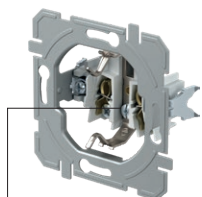
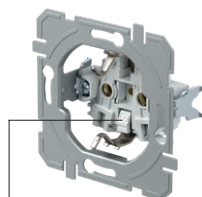
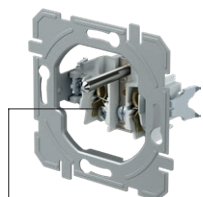
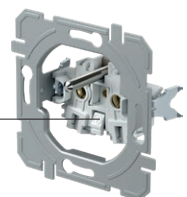
винтови контакти
screw contactsBV контакти чрез вкарване
BV plug-in contactsвинтови контакти
screw contactsBV контакти чрез вкарване
BV plug-in contacts

КОНТАКТ ШУКО 2P+E 16A 250V~ __ XO

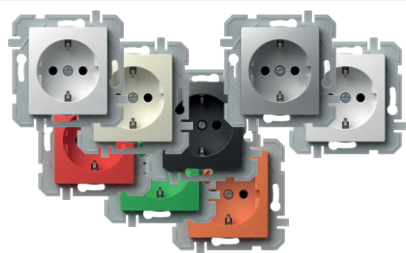

- VE10PWXO
- VE10IWXO
- VE10ESXO
- VE10COXO
- VE10NBXO
- VE10RDXO
- VE10GRXO
- VE10ORXO

- винтови контакти 1,5 - 2,5 mm²
- XO без панел
- 2P+E шуко
- 16A 250V~, тип VE10

SOCKET SCHUKO 2P+E 16A 250V~ __ XO

- screw contacts 1.5-2.5mm²
- XO without surround
- 2P+E schuko
- 16A 250V~, type VE10



КОНТАКТ ШУКО+КАПАК 2P+E 16 A 250 V~ __ XO

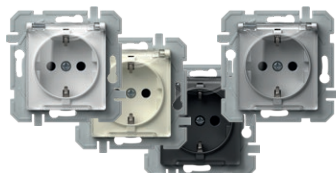

- VE11PTXO
- VE11ITXO
- VE11STXO
- VE11BTXO

- винтови контакти 1,5 - 2,5 mm²
- XO без рамка
- 2P+E шуко+капак
- 16 A 250 V~, тип VE11

SOCKET SCHUKO+COVER 2P+E 16A 250V~ __ XO

- screw contacts 1.5-2.5mm²
- XO without surround
- 2P+E schuko+cover
- 16A 250V~, type VE11



КОНТАКТ ШУКО 2P+E 16A 250V~ BV __ XO

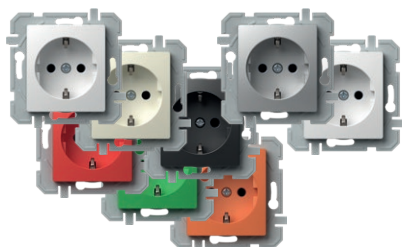

- VE12PWXO
- VE12IWXO
- VE12ESXO
- VE12COXO
- VE12NBXO
- VE12RDXO
- VE12GRXO
- VE12ORXO

- BV контакти чрез вкарване 1,5 - 2,5 mm²
- XO без панел
- 2P+E шуко
- 16A 250V~, тип VE12

SOCKET SCHUKO 2P+E 16A 250V~ BV __ XO

- BV plug-in contacts 1.5-2.5mm²
- XO without surround
- 2P+E schuko
- 16A 250V~, type VE12



КОНТАКТ ШУКО+КАПАК 2P+E 16A 250V~ BV __ XO

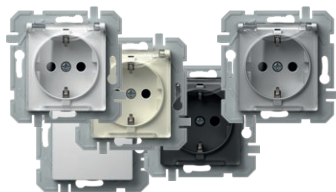

- VE13PTXO
- VE13ITXO
- VE13STXO
- VE13BTXO
- VE13PPXO

- BV контакти чрез вкарване 1,5 - 2,5 mm²
- XO без панел
- 2P+E шуко+капак
- 16A 250V~, тип VE13

SOCKET SCHUKO+COVER 2P+E 16A 250V~ BV __ XO

- BV plug-in contacts 1.5-2.5mm²
- XO without surround
- 2P+E schuko+cover
- 16A 250V~, type VE13



КОНТАКТ ШУКО 2P+E 16A 250V~



- VE10PW
- VE10IW
- VE10ES
- VE10CO
- VE10NB

- винтови контакти 1,5 - 2,5 mm²
- 2P+E шуко
- 16A 250V~, тип VE10

SOCKET SCHUKO 2P+E 16A 250V~

- screw contacts 1.5-2.5mm²
- 2P+E schuko
- 16A 250V~, type VE10



КОНТАКТ ШУКО+КАПАК 2P+E 16A 250V~



- VE11PT
- VE11IT
- VE11ST
- VE11CT
- VE11BT

- винтови контакти 1,5 - 2,5 mm²
- 2P+E шуко+капак
- 16A 250V~, тип VE11

SOCKET SCHUKO+COVER 2P+E 16A 250V~

- screw contacts 1.5-2.5mm²
- 2P+E schuko+cover
- 16A 250V~, type VE11



КОНТАКТ ШУКО 2P+E 16A 250V~ BV



- VE12PW
- VE12IW
- VE12ES
- VE12CO
- VE12NB

- BV контакти чрез вкарване 1,5 - 2,5 mm²
- 2P+E шуко
- 16A 250V~, тип VE12

SOCKET SCHUKO 2P+E 16A 250V~ BV

- BV plug-in contacts 1.5-2.5mm²
- 2P+E schuko
- 16A 250V~, type VE12



КОНТАКТ ШУКО+КАПАК 2P+E 16A 250V~ BV



- VE13PT
- VE13IT
- VE13ST
- VE13CT
- VE13BT

- BV контакти чрез вкарване 1,5 - 2,5 mm²
- 2P+E шуко+капак
- 16A 250V~, тип VE13

SOCKET SCHUKO+COVER 2P+E 16A 250V~ BV

- BV plug-in contacts 1.5-2.5mm²
- 2P+E schuko+cover
- 16A 250V~, type VE13



S O C K E T S V E

КОНТАКТ ФРЕНСКИ 2P+E 16A 250V~ __ XO

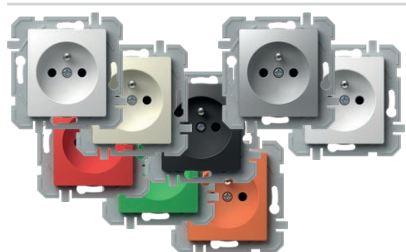

- VE40PWXO - винтови контакти 1,5 - 2,5 mm²
- VE40IWXO - XO без панел
- VE40ESXO - 2P+E френски контакт
- VE40COXO - 16A 250V~, тип VE40
- VE40NBXO
- VE40RDXO - screw contacts 1.5-2.5mm²
- VE40GRXO - XO without surround
- VE40ORXO - 2P+E French
- 16A 250V~, type VE40

SOCKET FRENCH 2P+E 16A 250V~ __ XO

- screw contacts 1.5-2.5mm²
- XO without surround
- 2P+E French
- 16A 250V~, type VE40



КОНТАКТ ФРЕНСКИ+КАПАК 2P+E 16A 250V~ __ XO



- VE41PTXO - винтови контакти 1,5 - 2,5 mm²
- VE41ITXO - XO без панел
- VE41STXO - 2P+E френски контакт+капак
- VE41PTXO - 16A 250V~, тип VE41
- VE41BTXO
- VE41PPXO

SOCKET FRENCH+COVER 2P+E 16A 250V~ __ XO

- screw contacts 1.5-2.5mm²
- XO without surround
- 2P+E French+cover
- 16A 250V~, type VE41



КОНТАКТ ФРЕНСКИ 2P+E 16A 250V~ BV __ XO

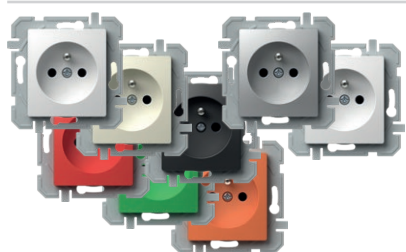

- VE42PWXO - BV контакти чрез вкарване 1,5 - 2,5 mm²
- VE42IWXO - XO без панел
- VE42ESXO - 2P+E френски контакт
- VE42COXO - 16A 250V~, тип VE42
- VE42NBXO
- VE42RDXO - BV plug-in contacts 1.5-2.5mm²
- VE42GRXO - XO without surround
- VE42ORXO - 2P+E French
- 16A 250V~, type VE42

SOCKET FRENCH 2P+E 16A 250V~ BV __ XO

- BV plug-in contacts 1.5-2.5mm²
- XO without surround
- 2P+E French
- 16A 250V~, type VE42



КОНТАКТ ФРЕНСКИ+КАПАК 2P+E 16 A 250 V~ BV __ XO



- VE43PTXO - BV контакти чрез вкарване 1,5 - 2,5 mm²
- VE43ITXO - XO без рамка
- VE43STXO - 2P+E френски контакт+капак
- VE43PTXO - 16 A 250 V~, тип VE43
- VE43BTXO
- VE43PPXO

SOCKET FRENCH+COVER 2P+E 16A 250V~ BV __ XO

- BV plug-in contacts 1.5-2.5mm²
- XO without surround
- 2P+E French+cover
- 16A 250V~, type VE43



КОНТАКТ ФРЕНСКИ 2P+E 16A 250V~



- VE40PW - винтови контакти 1,5 - 2,5 mm²
- VE40IW - 2P+E френски контакт
- VE40ES - 16A 250V~, тип VE40
- VE40CO
- VE40NB

SOCKET FRENCH 2P+E 16A 250V~

- screw contacts 1.5-2.5mm²
- 2P+E French
- 16A 250V~, type VE40



КОНТАКТ ФРЕНСКИ+КАПАК 2P+E 16A 250V~



- VE41PT - винтови контакти 1,5 - 2,5 mm²
- VE41IT - 2P+E френски контакт+капак
- VE41BT - 16A 250V~, тип VE41
- VE41ST

SOCKET FRENCH+COVER 2P+E 16A 250V~

- screw contacts 1.5-2.5mm²
- 2P+E French+cover
- 16A 250V~, type VE41



КОНТАКТ ФРЕНСКИ 2P+E 16A 250V~ BV



- VE42PW - BV контакти чрез вкарване 1,5 - 2,5 mm²
- VE42IW - 2P+E френски контакт
- VE42ES - 16A 250V~, тип VE42
- VE42CO
- VE42NB

SOCKET FRENCH 2P+E 16A 250V~ BV

- BV plug-in contacts 1.5-2.5mm²
- 2P+E French
- 16A 250V~, type VE42



КОНТАКТ ФРЕНСКИ+КАПАК 2P+E 16A 250V~ BV



- VE43PT - BV контакти чрез вкарване 1,5 - 2,5 mm²
- VE43IT - 2P+E френски контакт+капак
- VE43BT - 16A 250V~, тип VE43
- VE43ST

SOCKET FRENCH+COVER 2P+E 16A 250V~ BV

- BV plug-in contacts 1.5-2.5mm²
- 2P+E French+cover
- 16A 250V~, type VE43



КОНТАКТ ШУКО DOUBLE 2P+E 16A 250V~



- VE16PWKS
- VE16WKS
- VE16ESKS
- VE16NBKS

- 2P+E шуко двоен, 16A 250V~, тип VE16
- в съответствие с IEC 60884-1, CEE7
- винтови контакти 1,5 - 2,5 mm²
- KS защита от допир на контакти

SOCKET SCHUKO DOUBLE 2P+E 16A 250V~

- 2P+E schuko double
- 16A 250V~, type VE16
- in accordance with IEC 60884-1, CEE7
- screw contacts 1.5-2.5 mm²
- KS shuttered live contacts



КОНТАКТ ФРЕНСКИ ДВОЕН 2P+E 16A 250V~



- VE46PWKS
- VE46WKS
- VE46ESKS
- VE46NBKS

- 2P+E френски двоен, 16A 250V~, тип VE46
- в съответствие с IEC 60884-1, CEE7; NF C 61-314, CSN 33 2318; PN-E 93201
- винтови контакти 1,5 - 2,5 mm²
- KS защита от допир на контакти

SOCKET FRENCH DOUBLE 2P+E 16A 250V~

- 2P+E French double
- 16A 250V~, type VE46
- in accordance with IEC 60884-1, CEE7; NF C 61-314, CSN 33 2318; PN-E 93201
- screw contacts 1.5-2.5 mm²
- KS shuttered live contacts



КОНТАКТ 2P 16A 250V~

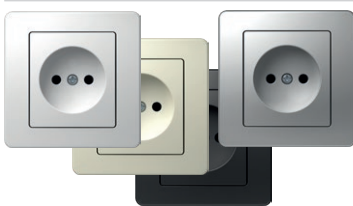

- VE30PW
- VE30IW
- VE30ES
- VE30NB

- 2P без контакт за заземяване
- 16A 250V~
- в съответствие с EN 60884-1, CEE7 (лист със стандарти I)
- винтови контакти 1,5 - 2,5 mm²

SOCKET 2P 16A 250V~

- 2P without earthing contact
- 16A 250V~
- in accordance with EN 60884-1, CEE7 (standard sheet I)
- screw contacts 1.5-2.5mm²

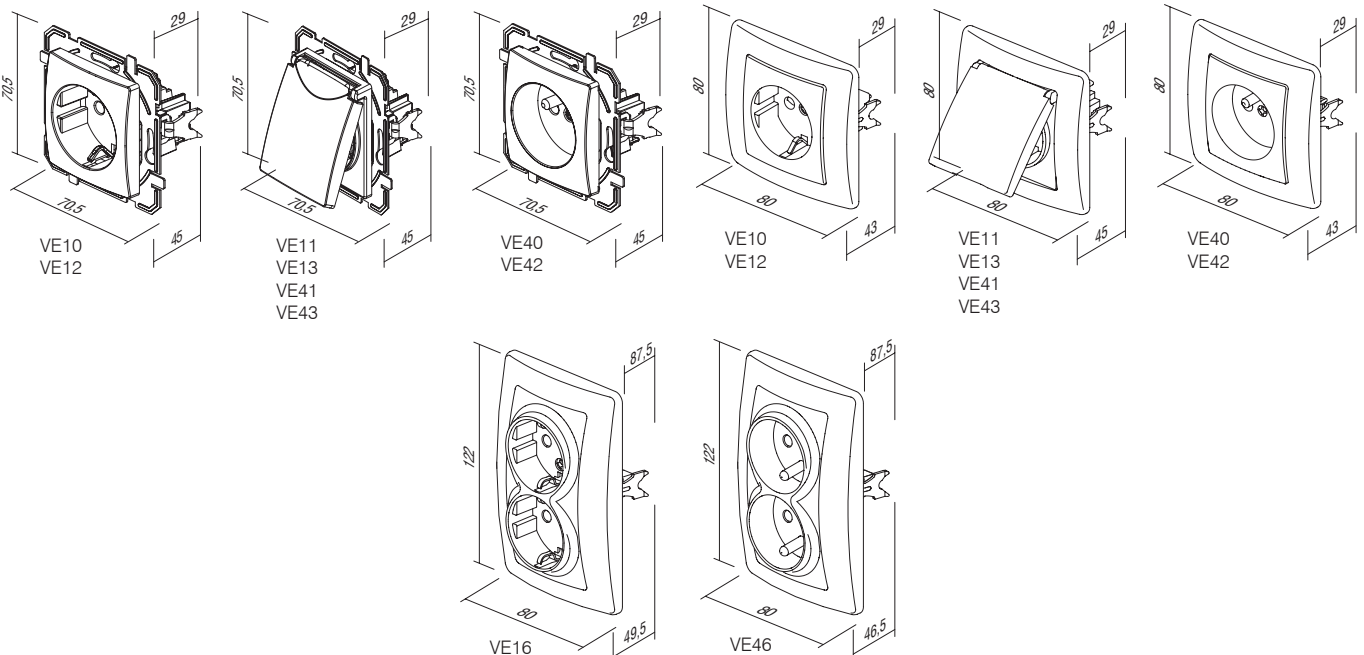



KE37

PW

тип type	описание description	технически данни technical data	цвет colour
KE11	КОНЕКТОР ЗА ТВ-РАДИО КРАЕН SOCKET TV-R END-LINE	1dB	<input type="checkbox"/> PW снежнобял цвят polar white
KE12	КОНЕКТОР ЗА ТВ-РАДИО ПРЕХОДЕН SOCKET TV-R THROUGHPASS	10dB	<input type="checkbox"/> IW слонова кост ivory white
KE16	КОНЕКТОР ЗА СATEЛИТНА ТВ-РАДИО КРАЕН SOCKET SAT-TV-R END-LINE	3dB	<input type="checkbox"/> ES сребрист цвят с анодизирано покритие elox silver
⋮	⋮	⋮	<input type="checkbox"/> CO бял с термореактивен материал white thermoset
⋮	⋮	⋮	<input type="checkbox"/> NB тъмночерен night black

КОНЕКТОР ЗА ТВ-РАДИО КРАЕН 1 dB



KE11

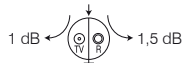

- за ТВ-радио краен
- честотен обхват 5÷862 MHz
- затихване: Радио-1,5 dB, ТВ-1 dB
- в съответствие с EN 50083-1
- винтови контакти

SOCKET TV-R END-LINE 1dB

- TV-R end-line
- frequency range 5÷862MHz
- reduction: R-1.5dB, TV-1dB
- in accordance with EN 50083-1
- screw contacts

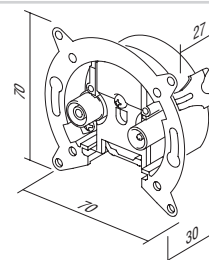

КОНЕКТОР ЗА ТВ-РАДИО ПРЕХОДЕН 10 dB



KE12

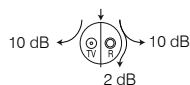

- преходник за ТВ-радио
- честотен обхват 5÷862 MHz
- затихване: Радио-10 dB, ТВ-10 dB, преход-2 dB
- в съответствие с EN 50083-1
- винтови контакти

SOCKET TV-R THROUGHPASS 10dB

- TV-R throughpass
- frequency range 5÷862MHz
- reduction: R-10dB, TV-10dB, through-2dB
- in accordance with EN 50083-1
- screw contacts

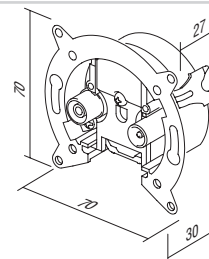

КОНЕКТОР ЗА СATEЛИТНА ТВ-РАДИО КРАЕН 3 dB



KE16

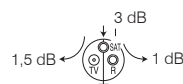

- за сателитна ТВ-радио краен
- честотен обхват 5÷2400 MHz
- затихване: Радио-1dB, ТВ-1,5dB, сателитна ТВ-3 dB
- за монтаж в кръгла конзола Ø60 с крачета или винтове
- в съответствие с EN 50083-1
- винтови контакти

SOCKET SAT-TV-R END-LINE 3dB

- SAT-TV-R end-line
- frequency range 5÷2400MHz
- reduction: R-1dB, TV-1.5dB, SAT-3dB
- for mounting in round box Ø60 with claws or screws
- in accordance with EN 50083-1
- screw contacts

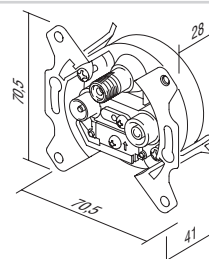

КОНЕКТОР ЗА ТЕЛЕФОН KS RJ11 6/4

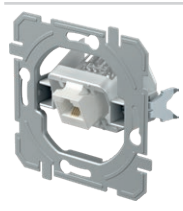

KE36

- KS модул стандарт за закрепване
- RJ11 6/4
- в съответствие с IEC 60603-7

SOCKET TEL KS RJ11 6/4

- KS keystone fixing standard
- RJ11 6/4
- in accordance with IEC 60603-7

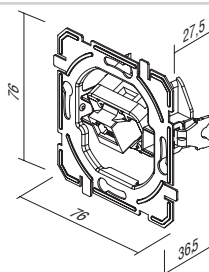

КОНЕКТОР CAT5e KS RJ45 8/8

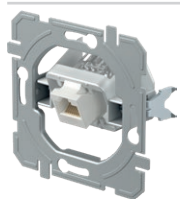

KE37

- KS модулен стандарт за закрепване
- CAT5e, RJ45 8/8
- в съответствие с IEC 60603-7

SOCKET CAT5e KS RJ45 8/8
 - KS keystone fixing standard
 - CAT5e, RJ45 8/8
 - in accordance with IEC 60603-7

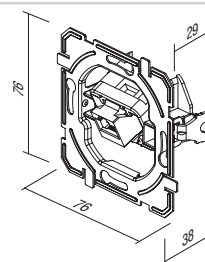

КОНЕКТОР CAT6s KS RJ45 8/8 SLIM

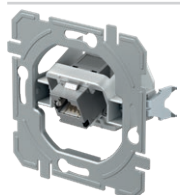

KE40

- KS модулен стандарт за закрепване
- CAT6s, RJ45 8/8
- в съответствие с IEC 60603-7

SOCKET CAT6s KS RJ45 8/8 SLIM
 - KS keystone fixing standard
 - CAT6s, RJ45 8/8
 - in accordance with IEC 60603-7

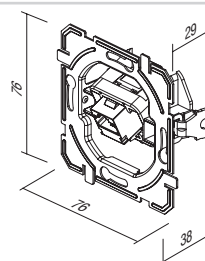

КОНЕКТОР ЗА ТЕЛЕФОН KS 2x RJ11 6/4

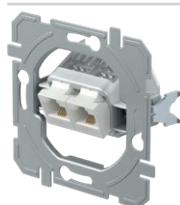

KE38

- KS модулен стандарт за закрепване
- 2 x RJ11 6/4
- в съответствие с IEC 60603-7

SOCKET TEL KS DOUBLE 2x RJ11 6/4
 - KS keystone fixing standard
 - 2x RJ11 6/4
 - in accordance with IEC 60603-7

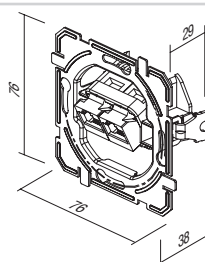

ДВОЕН КОНЕКТОР CAT5e KS 2x RJ45 8/8

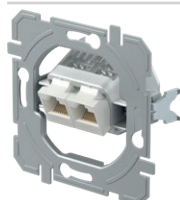

KE39

- KS модулен стандарт за закрепване
- 2 x CAT5e, RJ45 8/8
- в съответствие с IEC 60603-7

SOCKET CAT5e KS DOUBLE 2x RJ45 8/8
 - KS keystone fixing standard
 - 2x CAT5e, RJ45 8/8
 - in accordance with IEC 60603-7

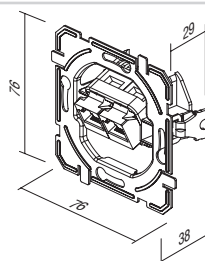

ДВОЕН КОНЕКТОР CAT6s KS 2x RJ45 8/8 SLIM



KE41

- KS модулен стандарт за закрепване
- 2 x CAT6s, RJ45 8/8
- в съответствие с IEC 60603-7

SOCKET CAT6s KS DOUBLE 2x RJ45 8/8 SLIM
 - KS keystone fixing standard
 - 2x CAT6s, RJ45 8/8
 - in accordance with IEC 60603-7

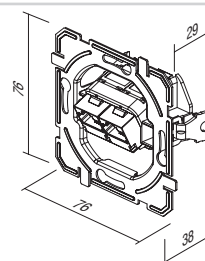

АДАПТЕР KS ЕДИНИЧЕН

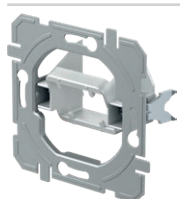

KE45

- KS модулен стандарт за закрепване – единичен
- AMP, Avaya, Brandrex, FMT, Mfico, Tyco, ...
- комуникационният модул не е включен в доставката

ADAPTER KS SINGLE
 - KS keystone fixing standard - single
 - AMP, Avaya, Brandrex, FMT, Mfico, Tyco, ...
 - communication module not included

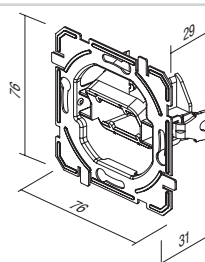

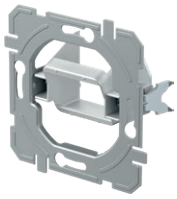

KE46

АДАПТЕР KS ДВОЕН

- KS модулен стандарт за закрепване – двоен
- AMP, Tyco, ...
- комуникационният модул не е включен в доставката

ADAPTER KS DOUBLE

- KS keystone fixing standard - double
- AMP, Tyco, ...
- communication module not included

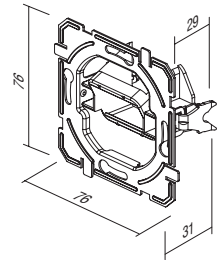

KE47

АДАПТЕР PD ДВОЕН

- стандарт за закрепване PD Panduit Mini-COM – двоен
- комуникационният модул не е включен в доставката

ADAPTER PD DOUBLE

- PD Panduit Mini-COM fixing standard - double
- communication module not included

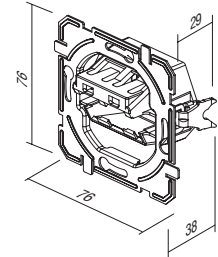

КОНЕКТОР ЗА ТВ ОСНОВЕН 0 dB



- KE10PW
- KE10IW
- KE10ES
- KE10CO
- KE10NB

- контакт за ТВ базов
- затихване 0 dB
- заден конектор – стандарт F

SOCKET TV BASIC 0dB

- TV basic
- reduction 0dB
- back connector – F standard



КОНЕКТОР ЗА ТВ-РАДИО КРАЕН 1 dB



- KE11PW
- KE11IW
- KE11ES
- KE11CO
- KE11NB

- за ТВ-радио краен
- честотен обхват 5÷862 MHz
- затихване: Радио-1.5 dB, ТВ-1 dB
- в съответствие с EN 50083-1
- винтови контакти

SOCKET TV-R END-LINE 1dB

- TV-R end-line
- frequency range 5÷862 MHz
- reduction: R-1.5dB, TV-1dB
- in accordance with EN 50083-1
- screw contact



КОНЕКТОР ЗА ТВ-РАДИО ПРЕХОДЕН 10 dB



- KE12PW
- KE12IW
- KE12ES
- KE12CO
- KE12NB

- преходник за ТВ-радио
- честотен обхват 5÷862 MHz
- затихване: Радио-10 dB, ТВ-10 dB, преход-2 dB
- в съответствие с EN 50083-1
- винтови контакти

SOCKET TV-R TROUGH-PASS 10dB

- TV-R troughpass
- frequency range 5÷862 MHz
- reduction: R-10dB, TV-10dB, trough-2dB
- in accordance with EN 50083-1
- screw contacts



КОНЕКТОР ЗА САТЕЛИТНА ТВ-ТВ-РАДИО КРАЕН 3 dB



- KE16PW
- KE16IW
- KE16ES
- KE16CO
- KE16NB

- за сателитна ТВ-ТВ-радио краен
- честотен обхват 5÷2400 MHz
- затихване: Радио-1dB, ТВ-1.5dB, сателитна ТВ-3 dB
- в съответствие с EN 50083-1
- винтови контакти

SOCKET SAT-TV-R END-LINE 3dB

- SAT-TV-R end-line
- frequency range 5÷2400 MHz
- reduction: R-1dB, TV-1.5dB, SAT-3dB
- in accordance with EN 50083-1
- screw contacts



КОНЕКТОР ЗА АУДИОСИГНАЛИ 2xRCA



- KE22PW
- KE22IW
- KE22ES
- KE22CO
- KE22NB

- за аудиосигнали, 2xRCA
- свързване на кабела чрез запояване

SOCKET AUDIO 2xRCA

- audio 2xRCA
- soldering connection of cable



КОНЕКТОР ЗА ВИСОКОГОВОРТЕЛИ



- KE23PW
- KE23IW
- KE23ES
- KE23CO
- KE23NB

- за аудиосигнали, 2x Ø4 mm
- за проводник за високоговорители, с щепсел тип банан Ø4 mm или плоски конектори
- свързване на кабела от задната страна чрез запояване

SOCKET AUDIO LOUDSPEAKERS

- audio 2x Ø4mm
- to accommodate speaker wire, banana plug Ø4mm or spades
- soldering connection of cable at the back side



КОНЕКТОР ЗА ТЕЛЕФОН KS RJ11 6/4

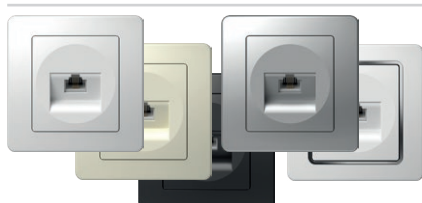

- KE36PW
- KE36IW
- KE36ES
- KE36CO
- KE36NB

- KS модул стандарт за закрепване
- RJ11 6/4
- в съответствие с IEC 60603-7

SOCKET TEL KS RJ11 6/4

- KS keystone fixing standard
- RJ11 6/4
- in accordance with IEC 60603-7





- KE37PW
- KE37IW
- KE37ES
- KE37CO
- KE37NB

КОНЕКТОР CAT5e KS RJ45 8/8

- KS модулен стандарт за закрепване
- CAT5e, RJ45 8/8
- в съответствие с IEC 60603-7

SOCKET CAT5e KS RJ45 8/8

- KS keystone fixing standard
- CAT5e, RJ45 8/8
- in accordance with IEC 60603-7

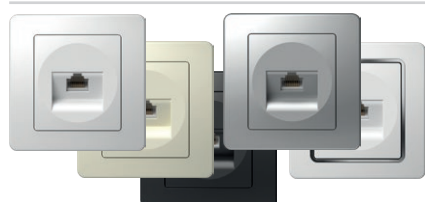

- KE40PW
- KE40IW
- KE40ES
- KE40CO
- KE40NB

КОНЕКТОР CAT6s KS RJ45 8/8 SLIM

- KS модулен стандарт за закрепване
- CAT6s, RJ45 8/8
- в съответствие с IEC 60603-7

SOCKET CAT6s KS RJ45 8/8 SLIM

- KS keystone fixing standard
- CAT6s, RJ45 8/8
- in accordance with IEC 60603-7

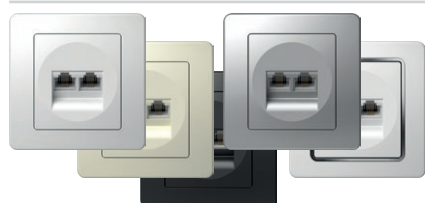

- KE38PW
- KE38IW
- KE38ES
- KE38CO
- KE38NB

КОНЕКТОР ЗА ТЕЛЕФОН KS 2x RJ11 6/4

- KS модулен стандарт за закрепване
- 2x RJ11, 6/4
- в съответствие с IEC 60603-7

SOCKET TEL KS DOUBLE 2x RJ11 6/4

- KS keystone fixing standard
- 2x RJ11, 6/4
- in accordance with IEC 60603-7



- KE39PW
- KE39IW
- KE39ES
- KE39CO
- KE39NB

ДВОЕН КОНЕКТОР CAT5e KS 2x RJ45 8/8

- KS модулен стандарт за закрепване
- 2 x CAT5e, RJ45 8/8
- в съответствие с IEC 60603-7

SOCKET CAT5e KS DOUBLE 2x RJ45 8/8

- KS keystone fixing standard
- 2x CAT5e, RJ45 8/8
- in accordance with IEC 60603-7



- KE41PW
- KE41IW
- KE41ES
- KE41CO
- KE41NB

ДВОЕН КОНЕКТОР CAT6s KS 2x RJ45 8/8 SLIM

- KS модулен стандарт за закрепване
- 2 x CAT6s, RJ45 8/8
- в съответствие с IEC 60603-7

SOCKET CAT6s KS DOUBLE 2x RJ45 8/8 SLIM

- KS keystone fixing standard
- 2x CAT6s, RJ45 8/8
- in accordance with IEC 60603-7

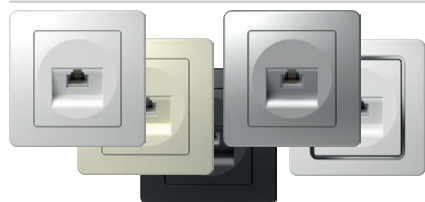

- KE35PW
- KE35IW
- KE35ES
- KE35CO
- KE35NB

КОНЕКТОР TEL LT RJ11 6/4

- телефонен LT винтов
- винтови контакти
- RJ11 6/4
- в съответствие с IEC 60603-7

SOCKET TEL LT RJ11 6/4

- TEL LT screw
- screw contacts
- RJ11 6/4
- in accordance with IEC 60603-7

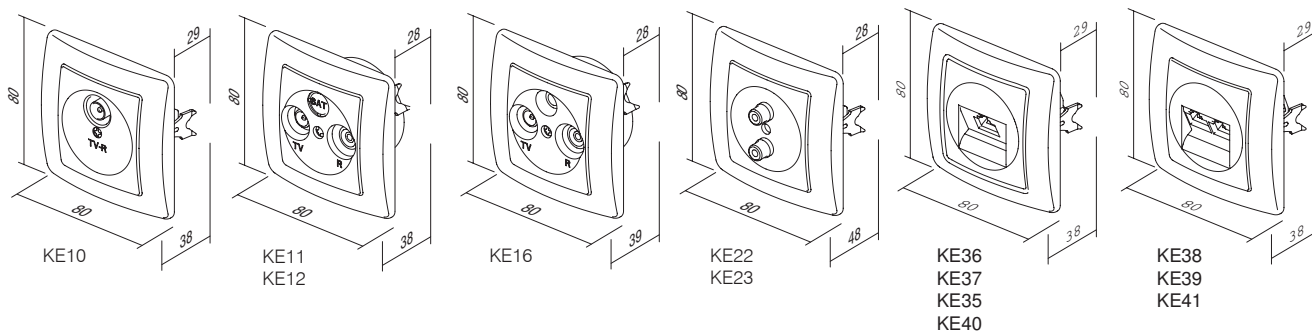

П А Н Е Л И З А К О М У Н И К А Ц И И К Е



PE20

PW

тип type	описание description	технически данни technical data	ЦВЯТ colour
PE10	ПАНЕЛ ЗА ТВ-РАДИО COVER TV-R	2P/3P	<input type="checkbox"/> PW снежнобял цвят polar white
PE20	ПАНЕЛ KS ЕДИНИЧЕН COVER KS SINGLE		<input type="checkbox"/> IW слонова кост ivory white
PE21	ПАНЕЛ KS ДВОЕН COVER KS DOUBLE		<input type="checkbox"/> ES сребрист цвят с анодизирано покритие elox silver
...	<input type="checkbox"/> CO бял с термореактивен материал white thermoset
			<input type="checkbox"/> NB тъмночерен night black

ПАНЕЛ ЗА ТВ-РАДИО 2P/3P

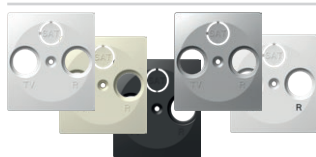

- PE10PW
- PE10IW
- PE10ES
- PE10CO
- PE10NB

- панел за ТВ-радио, 2P или 3P с винт

COVER TV-R 2P/3P

- TV-R cover, 2P or 3P with screw



ПАНЕЛ KS ЕДИНИЧЕН

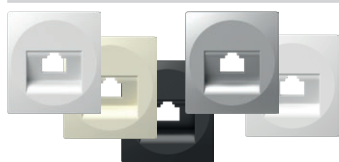

- PE20PW
- PE20IW
- PE20ES
- PE20CO
- PE20NB

- панел KS единичен

COVER KS SINGLE

- KS cover single



ПАНЕЛ KS ДВОЕН

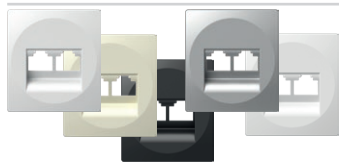

- PE21PW
- PE21IW
- PE21ES
- PE21NB

- панел KS двоен

COVER KS DOUBLE

- KS cover double



ПАНЕЛ TAE/TDO



- PE30PW
- PE30IW
- PE30ES
- PE30NB

- панел TAE или TDO с винт

COVER TAE/TDO

- TAE or TDO cover with screw

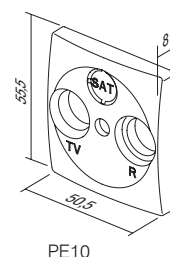
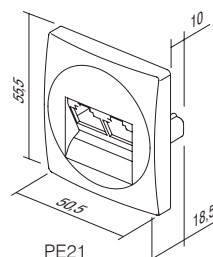
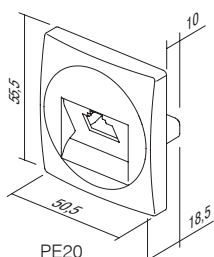
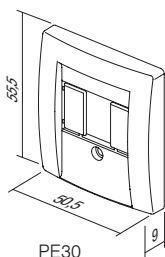



EE15

PW

тип type	описание description	технически данни technical data	цвет colour
EE15	DIMMER ROTATIVE 2WAY DIMMER ROTATIVE 2WAY	RL 400W	<input type="checkbox"/> PW снежнобял цвят polar white
EE16	DIMMER ROTATIVE 2WAY DIMMER ROTATIVE 2WAY	RLC 400W	<input type="checkbox"/> IW слонова кост ivory white
EE19	DIMMER ROTATIVE 2WAY DIMMER ROTATIVE 2WAY	LED 100W	<input type="checkbox"/> ES сребрист цвят с анодизирано покритие elox silver
⋮	⋮	⋮	<input type="checkbox"/> CO бял с термореактивен материал white thermoset
⋮	⋮	⋮	<input type="checkbox"/> NB тъмночерен night black

ДИМЕР, ВЪРТЯЩ ТИП/ДВУПОСОЧЕН, АКТИВЕН/ИНДУКТИВЕН ТОВАР 400 W



EE15

- управление чрез завъртане, с двупосочен ключ
- активен/индуктивен товар, 40 W – 400 W
- възможна е комбинация с двупосочен ключ
- не се допуска комбинация с допълнителни димери
- в съответствие с EN 60669-1 и EN 60669-2-1
- контакти чрез вкарване на проводниците 1,5 mm²
- захранващо напрежение 230 V~ 50 Hz
- вътрешен диаметър на бутона Ø6 mm
- предпазител за смяна е включен в доставката

DIMMER ROTATIVE 2WAY RL 400W

- rotation control with 2-way switch
- load RL, 40W - 400W
- 2-way switch combination is possible
- more dimmers combination is not allowed
- in accordance with EN 60669-1 and EN 60669-2-1
- plug-in contacts 1.5mm²
- supply 230V~ 50Hz
- button inner diameter Ø6mm
- replaceable fuse included

ДИМЕР, ВЪРТЯЩ ТИП/ДВУПОСОЧЕН, АКТИВЕН/ИНДУКТИВЕН/КАПАЦИТИВЕН ТОВАР 400 W

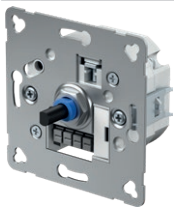

EE16

- управление чрез завъртане, с двупосочен ключ
- активен/индуктивен/капацитивен товар, 20 W – 400 W
- възможна е комбинация с двупосочен ключ
- не се допуска комбинация с допълнителни димери
- в съответствие с EN 60669-1 и EN 60669-2-1
- контакти чрез вкарване на проводниците 1,5 mm²
- захранващо напрежение 230 V~ 50 Hz
- вътрешен диаметър на бутона Ø6 mm
- електронен предпазител

DIMMER ROTATIVE 2WAY RLC 400W

- rotation control with 2-way switch
- load RLC, 20W - 400W
- 2-way switch combination is possible
- more dimmers combination is not allowed
- in accordance with EN 60669-1 and EN 60669-2-1
- plug-in contacts 1.5mm²
- supply 230V~ 50Hz
- button inner diameter Ø6mm
- electronic fuse



EE19

ДИМЕР, ВЪРТЯЩ ТИП/ДВУПОСОЧЕН, ЗА СВЕТОДИОДНО ОСВЕТЛЕНИЕ 100 W

- управление чрез завъртане, с двупосочен ключ
- товар: светодиодно осветление, 0 - 100 W (max. 10 светодиода)
GLS, 10-250 W
- възможна е комбинация с двупосочен ключ
- не се допуска комбинация с допълнителни димери
- в съответствие с EN 60669-1 и EN 60669-2-1
- контакти чрез вкарване на проводниците 1,5 mm²
- захранващо напрежение 230 V~ 50 Hz
- предпазител за смяна е включен в доставката
- вътрешен диаметър на бутона Ø6 mm

DIMMER ROTATIVE 2WAY LED 100W

- rotation control with 2-way switch
- load: LED, 0-100W (max. 10 LEDs)
GLS, 10-250W
- 2-way switch combination is possible
- more dimmers combination is not allowed
- in accordance with EN 60669-1 and EN 60669-2-1
- plug-in contacts 1.5mm²
- supply 230V~ 50Hz
- replaceable fuse included
- button inner diameter Ø6mm

IR КЛЮЧ 5 А 250 V~

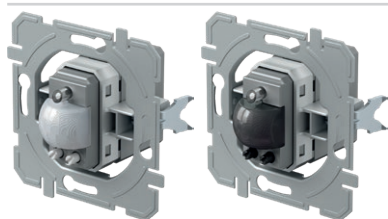

- EE32A1
- EE32A2

- инфрачервен ключ IR
- захранване: 230 V~ ±10 % 50 Hz
- реле: 5 A/250 V~ (нулевата стойност)
- клас на защита: IP40
- сечение на проводниците при контакта 0,75 - 2,5 mm²
- ъгъл на откриване: до 110° при 20° C
- разстояние на откриване: прил. 8 m при 20° C
- регулируема продължителност: от прил. 5 сек до 12 мин
- регулиране на яркостта на осветлението: от прил. 5 до 200 лукса
- работна температура: от 0° C до +40° C
- не е подходящо за инсталиране в конзоли с дълбочина 45 mm
- само за използване на закрито

IR SWITCH 5A 230V~

- IR infrared switch
- supply voltage: 230V~ ±10 % 50Hz
- relay: 5A / 250V~ (zero crossing)
- protection rating: IP40
- cross-section of wires at the contact terminal: 0.75 - 2.5 mm²
- detection angle: up to 110° at 20°C
- detection area: approx. 8 m at 20°C
- adjustability of duration: from approx. 5 s to 12 min
- adjustability of brightness: from approx. 5 to 200 LUX
- operating temperature: from 0°C to +40°C
- not suitable for installation in 45 mm deep boxes
- only for indoor usage

USB ЗАХРАНВАЩ БЛОК 5V 2,4A



EE67

- за зареждане на електронни устройства чрез стандартен USB порт (съвместим с устройства на Apple)
- захранване: 100-230V~ 50/60Hz
- консумация на енергия:
300mA при 100V~/150mA при 230V~
- консумация на енергия в режим на готовност: 30mW при 230V~
- номинално изходно напрежение: 5 VCD (± 5%) SELV
- изходно напрежение на пулсации: 150 mV
- номинален изходен ток: 2,4A (±10%)
- вид конектор: USB A/USB A
- ефективност: максимум 77%
- температура на работа: 0° C/+45° C (за употреба в затворени пространства)
- Клас на IP защита: IP20, само за употреба в затворени пространства
- устройство клас II
- категория свръхнапрежение (EN 62109): Клас III
- контакти с винтови клеми: макс. 2,5 mm²
- устройство с контактна междина най-малко 3 mm
- в съответствие с Директива EN 60950-1 и Директива за безопасност на нисковолтови електрически съоръжения (LVD) и Директива относно електромагнитна съвместимост (EMC)

USB POWER SUPPLY UNIT 5V 2.4A

- for charging electronic devices via a standard USB port (also compatible with Apple devices)
- power supply: 100-230V~ 50/60Hz
- power consumption: 300mA at 100V~/150mA at 230V~
- standby power consumption: 30mW at 230V~
- nominal output voltage: 5 VCD (± 5%) SELV
- output ripple voltage: 150mV
- nominal output current: 2.4A (±10%)
- connector type: USB A / USB A
- efficiency: maximum of 77%
- operating temperature: 0°C/+45°C (indoor use)
- IP protection class: IP20, indoor use only
- class device II
- overvoltage category (EN 62109): Class III
- screw contacts: max. 2.5 mm²
- device with a contact gap of at least 3mm
- in accordance with the EN 60950-1 and LVD & EMC directives

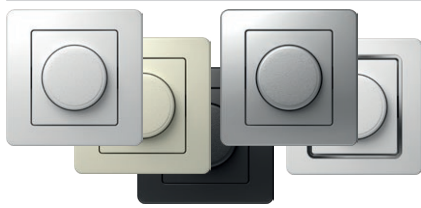

- EE15PW
- EE15IW
- EE15ES
- EE15CO
- EE15NB

ДИМЕР, ВЪРТЯЩ ТИП/ДУПОСОЧЕН, АКТИВЕН/ИНДУКТИВЕН ТОВАР 400 W

- управление чрез завъртане, с двупосочен ключ
- активен/индуктивен товар, 40 W – 400 W
- възможна е комбинация с двупосочен ключ
- не се допуска комбинация с допълнителни димери
- в съответствие с EN 60669-1 и EN 60669-2-1
- контакти чрез вкарване на проводниците 1,5 mm²
- захранващо напрежение 230 V~ 50 Hz
- предпазител за смяна е включен в доставката



DIMMER ROTATIVE 2WAY RL 400W

- rotation control with 2-way switch
- load RL, 40W - 400W
- 2-way switch combination is possible
- more dimmers combination is not allowed
- in accordance with EN 60669-1 and EN 60669-2-1
- plug-in contacts 1.5mm²
- supply 230V~ 50Hz
- replaceable fuse included

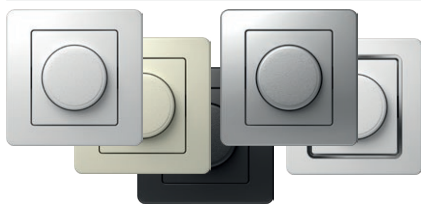

- EE16PW
- EE16IW
- EE16ES
- EE16CO
- EE16NB

ДИМЕР, ВЪРТЯЩ ТИП/ДУПОСОЧЕН, АКТИВЕН/ИНДУКТИВЕН/КАПАЦИТИВЕН ТОВАР 400 W

- управление чрез завъртане, с двупосочен ключ
- активен/индуктивен/капацитивен товар, 20 W – 400 W
- възможна е комбинация с двупосочен ключ
- не се допуска комбинация с допълнителни димери
- в съответствие с EN 60669-1 и EN 60669-2-1
- контакти чрез вкарване на проводниците 1,5 mm²
- захранващо напрежение 230 V~ 50 Hz
- електронен предпазител



DIMMER ROTATIVE 2WAY RLC 400W

- rotation control with 2-way switch
- load RLC, 20W - 400W
- 2-way switch combination is possible
- more dimmers combination is not allowed
- in accordance with EN 60669-1 and EN 60669-2-1
- plug-in contacts 1.5mm²
- supply 230V~ 50Hz
- electronic fuse



- EE19PW
- EE19IW
- EE19ES
- EE19CO
- EE19NB

ДИМЕР, ВЪРТЯЩ ТИП/ДУПОСОЧЕН, ЗА СВЕТОДИОДНО ОСВЕТЛЕНИЕ 100 W

- управление чрез завъртане, с двупосочен ключ
- товар: светодиодно осветление, 0 - 100 W (max. 10 светодиода)
GLS, 10-250 W
- възможна е комбинация с двупосочен ключ
- не се допуска комбинация с допълнителни димери
- в съответствие с EN 60669-1 и EN 60669-2-1
- контакти чрез вкарване на проводниците 1,5 mm²
- захранващо напрежение 230 V~ 50 Hz
- предпазител за смяна е включен в доставката



DIMMER ROTATIVE 2WAY LED 100W

- rotation control with 2-way switch
- load: LED, 0-100W (max. 10 LEDs)
GLS, 10-250W
- 2-way switch combination is possible
- more dimmers combination is not allowed
- in accordance with EN 60669-1 and EN 60669-2-1
- plug-in contacts 1.5mm²
- supply 230V~ 50Hz
- replaceable fuse included



- EE32PW
- EE32IW
- EE32ES
- EE32CO
- EE32NB

IR КЛЮЧ 5 A 230V~

- инфрачервен ключ IR
- захранване: 230 V~ ±10 % 50 Hz
- реле: 5 A/250 V~ (нулевата стойност)
- клас на защита: IP40
- сечение на проводниците при контакта 0,75 - 2,5 mm²
- ъгъл на откриване: до 110° при 20° C
- разстояние на откриване: прил. 8 m при 20° C
- регулируема продължителност: от прил. 5 сек до 12 мин
- регулиране на яркостта на осветлението: от прил. 5 до 200 лукса
- работна температура: от 0° C до +40° C
- не е подходящо за инсталиране в конзоли с дълбочина 45 mm
- само за използване на закрито



IR SWITCH 5A 230V~

- IR infrared switch
- supply voltage: 230V~ ±10 % 50Hz
- relay: 5A / 250V~ (zero crossing)
- protection rating: IP40
- cross-section of wires at the contact terminal: 0.75 - 2.5 mm²
- detection angle: up to 110° at 20°C
- detection area: approx. 8 m at 20°C
- adjustability of duration: from approx. 5 s to 12 min
- adjustability of brightness: from approx. 5 to 200 LUX
- operating temperature: from 0°C to +40°C
- not suitable for installation in 45 mm deep boxes
- only for indoor usage



- EE67PW
- EE67IW
- EE67NB
- EE67ES

USB ЗАХРАНВАЩ БЛОК 5V 2,4A

- за зареждане на електронни устройства чрез стандартен USB порт (съвместим с устройства на Apple)
- захранване: 100-230V~ 50/60Hz
- консумация на енергия: 300mA при 100V~/150mA при 230V~
- консумация на енергия в режим на готовност: 30mW при 230V~
- номинално изходно напрежение: 5 VCD ($\pm 5\%$) SELV
- изходно напрежение на пулсации: 150 mV
- номинален изходен ток: 2,4A ($\pm 10\%$)
- вид конектор: USB A/USB A
- ефективност: максимум 77%
- температура на работа: 0°C/+45°C (за употреба в затворени пространства)
- Клас на IP защита: IP20, само за употреба в затворени пространства
- устройство клас II
- категория свръхнапрежение (EN 62109): Клас III
- контакти с винтови клеми: макс. 2,5 mm²
- устройство с контактна междина най-малко 3 mm
- в съответствие с Директива EN 60950-1 и Директива за безопасност на нисковолтови електрически съоръжения (LVD) и Директива относно електромагнитна съвместимост (EMC)



USB POWER SUPPLY UNIT 5V 2.4A

- for charging electronic devices via a standard USB port (also compatible with Apple devices)
- power supply: 100-230V~ 50/60Hz
- power consumption: 300mA at 100V~/150mA at 230V~
- standby power consumption: 30mW at 230V~
- nominal output voltage: 5 VCD ($\pm 5\%$) SELV
- output ripple voltage: 150mV
- nominal output current: 2.4A ($\pm 10\%$)
- connector type: USB A / USB A
- efficiency: maximum of 77%
- operating temperature: 0°C/+45°C (indoor use)
- IP protection class: IP20, indoor use only
- class device II
- overvoltage category (EN 62109): Class III
- screw contacts: max. 2.5 mm²
- device with a contact gap of at least 3mm
- in accordance with the EN 60950-1 and LVD & EMC directives

EE15, EE16, EE19

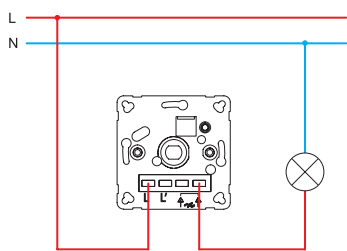

EE15, EE16, EE19

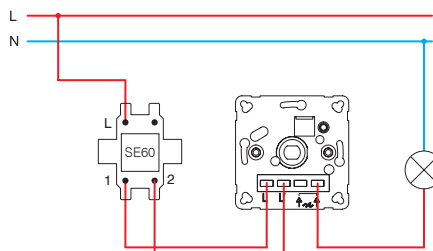

EE15, EE16, EE19

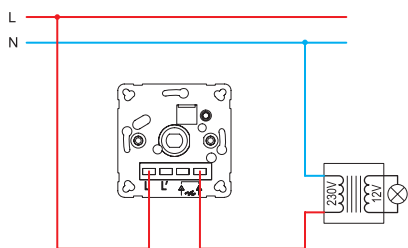

EE15, EE16, EE19

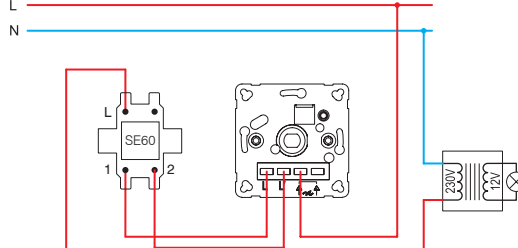

EE16, EE19

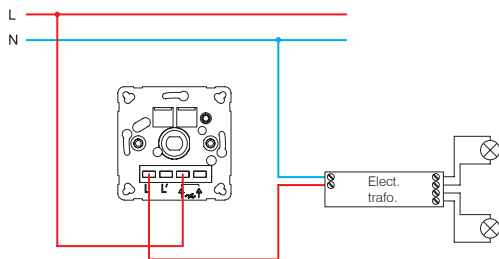

EE16, EE19

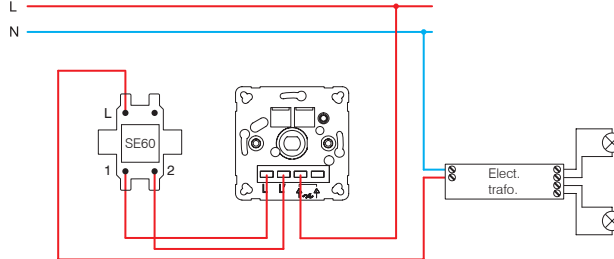

EE15 (40÷400W)

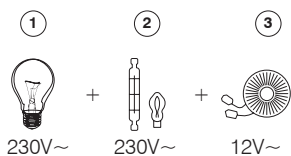

EE16 (20÷400W)

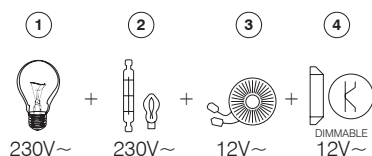

EE19 (GLS 10÷250W ; LED 0÷100W)

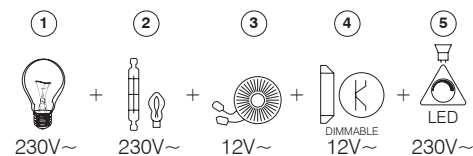

- 1 – лампа с нажежаема жичка / incandescent lamp
- 2 – халогенна лампа / halogen lamp

- 3 – класически трансформатор / classical transformer
- 4 – Димиращ електронен трансформатор / dimmable electronic transformer
- 5 – димируема светодиодна лампа / dimmable LED lamp

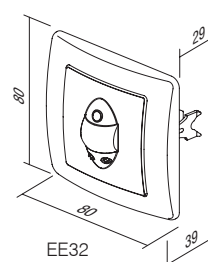
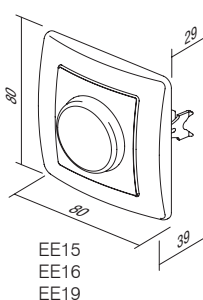
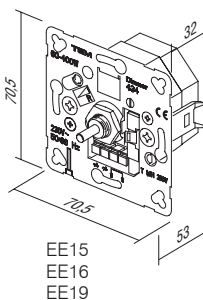
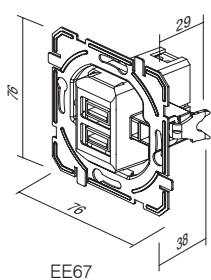

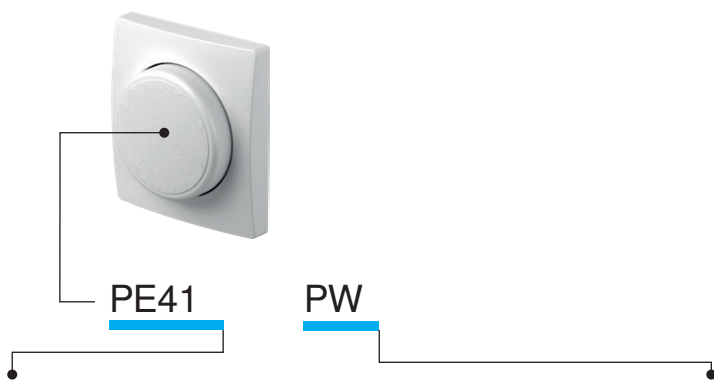

тип type	описание description	ЦВЯТ colour
PE41	ПАНЕЛ ЗА ДИМЕР COVER DIMMER	<input type="checkbox"/> PW снежнобял цвят polar white <input type="checkbox"/> IW слонова кост ivory white <input type="checkbox"/> ES сребрист цвят с анодизирано покритие elox silver <input type="checkbox"/> CO бял с термореактивен материал white thermoset <input type="checkbox"/> NB тъмночерен night black

ПАНЕЛ ЗА ДИМЕР Ø6



- PE41PW
- PE41IW
- PE41NB
- PE41ES
- PE41CO

- панел за димер Ø6 mm
- за EE15, EE16, EE19

COVER DIMMER Ø6

- cover dimmer Ø6mm
- for EE15, EE16, EE19



ПАНЕЛ IR КЛЮЧ



- PE32PW
- PE32IW
- PE32NB
- PE32ES

- панел за ИЧ ключ

COVER IR SWITCH

- cover IR switch



КАПАК ЗА USB ЗАХРАНВАЩ БЛОК



- PE67PW
- PE67IW
- PE67NB
- PE67ES

- Капак за USB захранващ блок

USB SUPPLY UNIT COVER

- USB supply unit cover

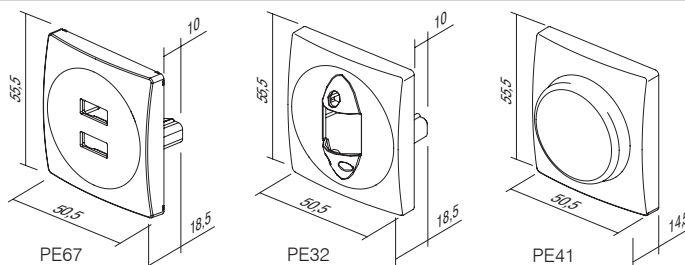

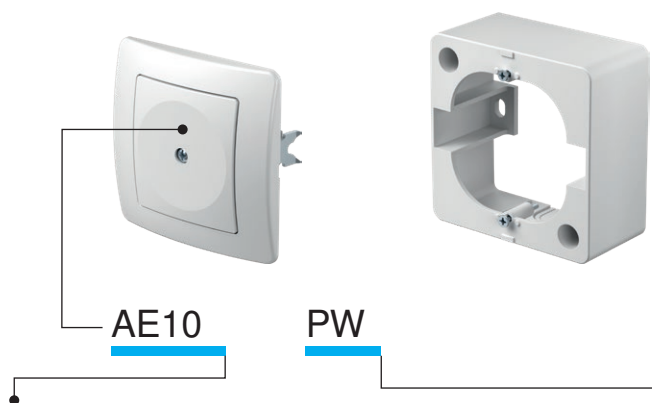

тип type	описание description	цвет colour
AE10	КАПАЧЕ BLANK	<input type="checkbox"/> PW снежнобял цвят polar white
AE20	СЪЕДИНИТЕЛНА КОНЗОЛА 5POLE 3P+N+E 5x4 mm ² CONNECTION BOX 3P+N+E 5X4mm ²	<input type="checkbox"/> IW слонова кост ivory white
AE30	КОНЗОЛА ЗА ВЪНШЕН МОНТАЖ 1 SURFACE MOUNT BOX	<input type="checkbox"/> ES сребрист цвят с анодизирано покритие elox silver
·	·	<input type="checkbox"/> CO бял с термореактивен материал white thermoset
·	·	<input type="checkbox"/> NB тъмночерен night black

КАПАЧЕ

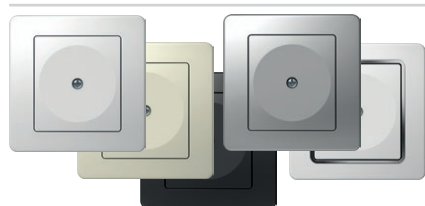

- AE10PW
- AE10IW
- AE10NB
- AE10ES
- AE10CO

- за запълване на празни позиции

BLANK

- for filling up empty spaces

СЪЕДИНИТЕЛНА КОНЗОЛА 5POLE 3P+N+E 5x4 mm²

- AE20PW
- AE20IW

- съединителна конзола 3P +N+E
- 16 A 400 V~
- в съответствие с VDE 0606-1:2000
- винтови контакти 1,5 - 4 mm²

CONNECTION BOX 5POLE 3P+N+E 5x4mm²

- 3P+N+E connection box
- 16A 400V~
- in accordance with VDE 0606-1:2000
- screw contacts 1.5-4mm²



КОНЗОЛА ЗА ВЪНШЕН МОНТАЖ 1

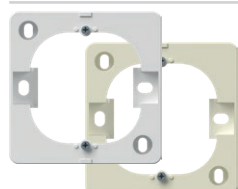

- AE30PW
- AE30IW

- конзола за външен монтаж

SURFACE MOUNT BOX 1

- surface mounting box



КУТИЯ ЗА МОНТАЖ НА ПОВЪРХНОСТИ ЗА ДВОЕН КОНТАКТ

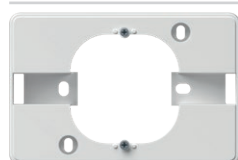

- AE31PW

- конзола за външен монтаж

SURFACE MOUNT BOX FOR

EKONOMIK DOUBLE SOCKET

- surface mounting box



СТЕННА ЗАЩИТА



- AE50PW
- AE50TS

- защитава повърхността около контакт или ключ

WALL PROTECTION

- protects surface around socket or switch

ЗАЩИТА ЗА ДЕЦА KS



- AE51PW
- AE51IW

- KS допълнителен елемент за защита за деца

CHILD PROTECTION KS

- KS additional child protection insert - shuttered live contacts

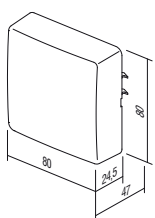

AE20

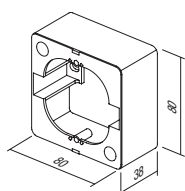

AE30

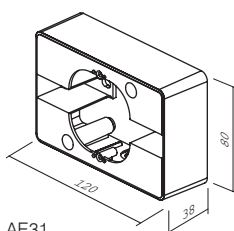

AE31

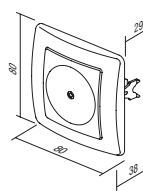

AE10

S U R R O U N D S O E

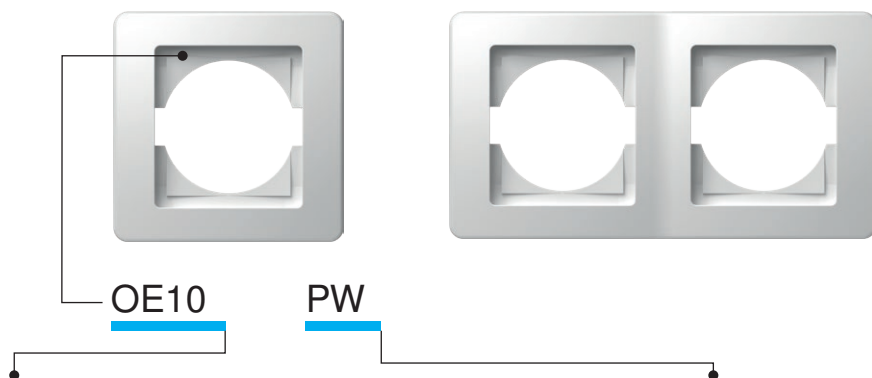

тип type	описание description	цвет colour
OE10	РАМКА ЕКОНОМИК 1 SURROUND EKONOMIK 1	<input type="checkbox"/> PW снежнобял цвят polar white
OE20	РАМКА ЕКОНОМИК 2 ХОРИЗОНТАЛНА SURROUND EKONOMIK 2 HORIZONTAL	<input type="checkbox"/> IW слонова кост ivory white
OE30	РАМКА ЕКОНОМИК 3 ХОРИЗОНТАЛНА SURROUND EKONOMIK 3 HORIZONTAL	<input type="checkbox"/> ES сребрист цвят с анодизирано покритие elox silver
⋮	⋮	<input type="checkbox"/> CO бял с термореактивен материал white thermoset
⋮	⋮	<input type="checkbox"/> NB тъмночерен night black

РАМКА ЕКОНОМИК 1



- OE10PW
- OE10IW
- OE10ES
- OE10CO
- OE10NB

- декоративна рамка единична
- в съответствие с EN 60669-1

SURROUND EKONOMIK 1
- decorative surround 1-gang
- in accordance with EN 60669-1

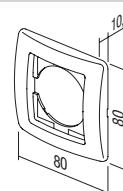

РАМКА ЕКОНОМИК 2 ХОРИЗОНТАЛНА



- OE20PW
- OE20IW
- OE20ES
- OE20CO
- OE20NB

- декоративна рамка двойна хоризонтална
- в съответствие с EN 60669-1

SURROUND EKONOMIK 2 HORIZONTAL
- decorative surround 2-gang horizontal
- in accordance with EN 60669-1

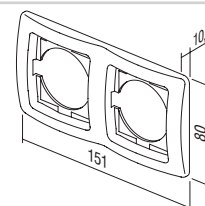

РАМКА ЕКОНОМИК 2 ВЕРТИКАЛНА



- OE21PW
- OE21IW
- OE21ES
- OE21CO
- OE21NB

- декоративна рамка двойна вертикална
- в съответствие с EN 60669-1

SURROUND EKONOMIK 2 VERTICAL
- decorative surround 2-gang vertical
- in accordance with EN 60669-1

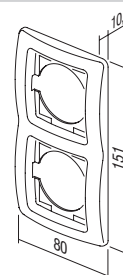

РАМКА ЕКОНОМИК 3 ХОРИЗОНТАЛНА



- OE30PW
- OE30IW
- OE30ES
- OE30CO
- OE30NB

- декоративна рамка тройна хоризонтална
- в съответствие с EN 60669-1

SURROUND EKONOMIK 3 HORIZONTAL
- decorative surround 3-gang horizontal
- in accordance with EN 60669-1

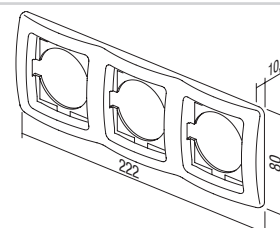



- OE31PW
- OE31IW
- OE31ES
- OE31CO
- OE31NB

РАМКА ЕКОНОМИК 3 ВЕРТИКАЛНА

- декоративна рамка тройна вертикална
- в съответствие с EN 60669-1

SURROUND EKONOMIK 3 VERTICAL

- decorative surround 3-gang vertical
- in accordance with EN 60669-1

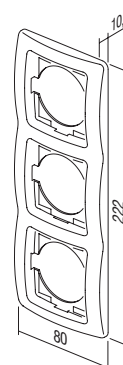

- OE40PW
- OE40IW
- OE40ES
- OE40NB

РАМКА ЕКОНОМИК 4 ХОРИЗОНТАЛНА

- декоративна рамка четворна хоризонтална
- в съответствие с EN 60669-1

SURROUND EKONOMIK 4 HORIZONTAL

- decorative surround 4-gang horizontal
- in accordance with EN 60669-1

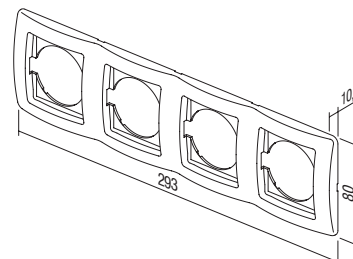

- OE41PW
- OE41IW
- OE41ES
- OE41NB

РАМКА ЕКОНОМИК 4 ВЕРТИКАЛНА

- декоративна рамка четворна вертикална
- в съответствие с EN 60669-1

SURROUND EKONOMIK 4 VERTICAL

- decorative surround 4-gang vertical
- in accordance with EN 60669-1

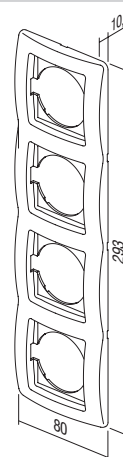

- OE50PW
- OE50IW
- OE50ES
- OE50NB

РАМКА ЕКОНОМИК 5 ХОРИЗОНТАЛНА

- декоративна рамка петорна хоризонтална
- в съответствие с EN 60669-1

SURROUND EKONOMIK 5 HORIZONTAL

- decorative surround 5-gang horizontal
- in accordance with EN 60669-1

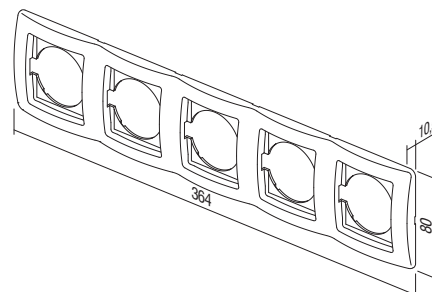

ЦВЕТНИ ДЕКОРАТИВНИ РАМКИ /
 COLOR DECORATIVE FRAMES



OE90GR	ЗЕЛЕНА / GREEN	OE90YL	ЖЪЛТА / YELLOW	OE90MB	МЕТ. СИНЯ / MET. BLUE
OE90BL	СИНЯ / BLUE	OE90WH	БЯЛА / WHITE	OE90BZ	БРОНЗ / BRONZE
OE90VO	ВИОЛЕТОВА / VIOLET	OE90GY	СИВА / GREY	OE90CR	СРЕБРИСТА / SILVER
OE90PI	РОЗОВА / PINK	OE90BK	ЧЕРНА / BLACK	OE90GO	ЗЛАТИСТА / GOLD
OE90RD	ЧЕРВЕНА / RED				





fontana



TEM



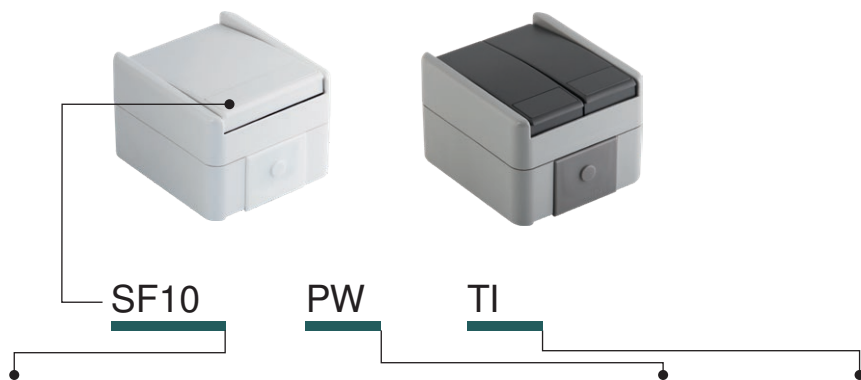

тип type	описание description	технически данни technical data	цвет colour	допълнителна информация 1 optional data 1
SF10	SWITCH 1WAY SWITCH 1WAY	IP44 10AX 250V~	<input type="checkbox"/> PW бял-матов white-mat	TI неонов лампа+индикация neon lamp+indication
SF11	PUSH BUTTON 1WAY PUSH BUTTON 1WAY	IP44 10A 250V~	<input type="checkbox"/> GY сив-матов grey-mat	
SF20	SWITCH 2POLE SWITCH 2POLE	IP44 10AX 250V~		
:	:	:		
:	:	:		

КЛЮЧ 1WAY IP44 10AX 250V~



- SF10PW
- SF10GY

- 10AX 250V~, тип SF10
- в съответствие с EN 60669-1
- контакти чрез вкарване 1,5 - 2,5 mm²

SWITCH 1WAY IP44 10AX 250V~
- 10AX 250V~, type SF10
- in accordance with EN 60669-1
- plug-in contacts 1.5-2.5mm²



КЛЮЧ 1WAY IP44 10AX 250V~ __ TI



- SF10PWTI
- SF10GYTI

- TI индикатор+неонова лампа
- 10AX 250V~, тип SF10
- в съответствие с EN 60669-1
- контакти чрез вкарване 1,5 - 2,5 mm²

SWITCH 1WAY IP44 10AX 250V~ __ TI
- TI indicator+neon lamp
- 10AX 250V~, type SF10
- in accordance with EN 60669-1
- plug-in contacts 1.5-2.5mm²



БУТОН 1WAY IP44 10A 250V~ __ TI



- SF11PWTI
- SF11GYTI

- TI индикатор+неонова лампа
- 10A 250V~, тип SF11
- в съответствие с EN 60669-1
- контакти чрез вкарване 1,5 - 2,5 mm²

PUSH BUTTON 1WAY IP44 10A 250V~ __ TI
- TI indicator+neon lamp
- 10A 250V~, type SF11
- in accordance with EN 60669-1
- plug-in contacts 1.5-2.5mm²



КЛЮЧ 2POLE IP44 10AX 250V~



- SF20PW
- SF20GY

- 10AX 250V~, тип SF20
- в съответствие с EN 60669-1
- контакти чрез вкарване 1,5 - 2,5 mm²

SWITCH 2POLE IP44 10AX 250V~
- 10AX 250V~, type SF20
- in accordance with EN 60669-1
- plug-in contacts 1.5-2.5mm²



	<ul style="list-style-type: none"> <input type="checkbox"/> SF50PW <input type="checkbox"/> SF50GY 	<p>КЛЮЧ 2GANG-1WAY IP44 10AX 250V~</p> <ul style="list-style-type: none"> - 10AX 250V~, тип SF50 - в съответствие с EN 60669-1 - контакти чрез вкарване 1,5 - 2,5 mm² <p><i>SWITCH 2GANG-1WAY IP44 10AX 250V~</i></p> <ul style="list-style-type: none"> - 10AX 250V~, type SF50 - in accordance with EN 60669-1 - plug-in contacts 1.5-2.5mm² 	
	<ul style="list-style-type: none"> <input type="checkbox"/> SF51PW <input type="checkbox"/> SF51GY 	<p>БУТОН 2GANG-1WAY IP44 10A 250V~</p> <ul style="list-style-type: none"> - 10 A 250 V~, тип SF51 - в съответствие с EN 60669-1 - контакти чрез вкарване 1,5 - 2,5 mm² <p><i>PUSH BUTTON 2GANG-1WAY IP44 10A 250V~</i></p> <ul style="list-style-type: none"> - 10A 250V~, type SF51 - in accordance with EN 60669-1 - plug-in contacts 1.5-2.5mm² 	
	<ul style="list-style-type: none"> <input type="checkbox"/> SF60PW <input type="checkbox"/> SF60GY 	<p>КЛЮЧ 2WAY IP44 10AX 250V~</p> <ul style="list-style-type: none"> - 10AX 250V~, тип SF60 - в съответствие с EN 60669-1 - контакти чрез вкарване 1,5 - 2,5 mm² <p><i>SWITCH 2WAY IP44 10AX 250V~</i></p> <ul style="list-style-type: none"> - 10AX 250V~, type SF60 - in accordance with EN 60669-1 - plug-in contacts 1.5-2.5mm² 	
	<ul style="list-style-type: none"> <input type="checkbox"/> SF60PWTI <input type="checkbox"/> SF60GYTI 	<p>КЛЮЧ 2WAY IP44 10AX 250V~ __ TI</p> <ul style="list-style-type: none"> - TI индикатор+неонова лампа - 10AX 250V~, тип SF60 - в съответствие с EN 60669-1 - контакти чрез вкарване 1,5 - 2,5 mm² <p><i>SWITCH 2WAY IP44 10AX 250V~ __ TI</i></p> <ul style="list-style-type: none"> - TI indicator+neon lamp - 10AX 250V~, type SF60 - in accordance with EN 60669-1 - plug-in contacts 1.5-2.5mm² 	
	<ul style="list-style-type: none"> <input type="checkbox"/> SF63PW <input type="checkbox"/> SF63GY 	<p>КЛЮЧ 2WAY DOUBLE IP44 10AX 250V~</p> <ul style="list-style-type: none"> - 10AX 250V~, тип SF63 - в съответствие с EN 60669-1 - контакти чрез вкарване 1,5 - 2,5 mm² <p><i>SWITCH 2WAY DOUBLE IP44 10AX 250V~</i></p> <ul style="list-style-type: none"> - 10AX 250V~, type SF63 - in accordance with EN 60669-1 - plug-in contacts 1.5-2.5mm² 	
	<ul style="list-style-type: none"> <input type="checkbox"/> SF70PW <input type="checkbox"/> SF70GY 	<p>КРЪСТАТ КЛЮЧ IP44 10AX 250V~</p> <ul style="list-style-type: none"> - 10AX 250V~, тип SF70 - в съответствие с EN 60669-1 - контакти чрез вкарване 1,5 - 2,5 mm² <p><i>SWITCH INTERMEDIATE IP44 10AX 250V~</i></p> <ul style="list-style-type: none"> - 10AX 250V~, type SF70 - in accordance with EN 60669-1 - plug-in contacts 1.5-2.5mm² 	

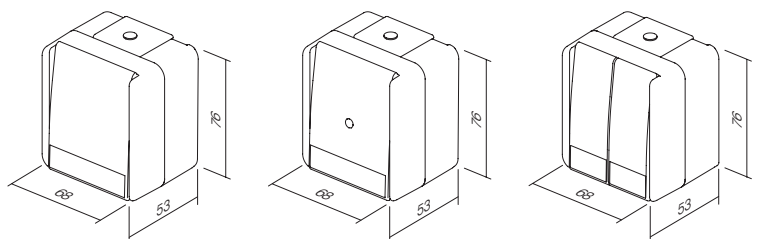

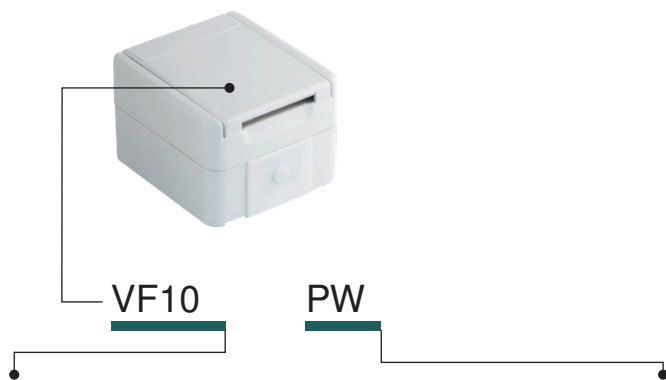

тип type	описание description	технически данни technical data	цвет colour
VF10	КОНТАКТ SCHUKO+КАПАК SOCKET SCHUKO+COVER	IP44 2P+E 16A 250V~	<input type="checkbox"/> PW бял-матов white-mat <input type="checkbox"/> GY сив-матов grey-mat



- VF10PW
- VF10GY

КОНТАКТ SCHUKO+КАПАК IP44 2P+E 16A 250V~

- винтови контакти 1,5 - 2,5 mm²
- 2P+E шуко+капак
- 16A 250 V~, тип VF10
- в съответствие с EN 60884-1, CEE7

SOCKET SCHUKO+COVER IP44 2P+E 16A 250V~

- screw contacts 1.5-2.5mm²
- 2P+E schuko+cover
- 16A 250V~, type VF10
- in accordance with EN 60884-1, CEE7



- VF12PW
- VF12GY

КОНТАКТ SCHUKO+КАПАК IP44 2P+E 16A 250V~ BV

- BV контакти чрез вкарване 1,5 - 2,5 mm²
- 2P+E шуко+капак
- 16A 250 V~, тип VF12
- в съответствие с EN 60884-1, CEE7

SOCKET SCHUKO+COVER IP44 2P+E 16A 250V~ BV

- BV plug-in contacts 1.5-2.5mm²
- 2P+E schuko+cover
- 16A 250V~, type VF12
- in accordance with EN 60884-1, CEE7

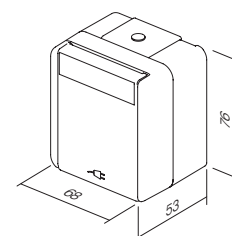

SF10
SF60

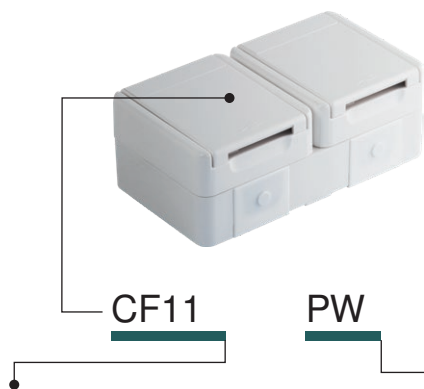

тип type	описание description	технически данни technical data	цвет colour
CF10	КОМПЛЕКТ КОНТАКТИ ШУКО ДВОЙНИ ХОРИЗОНТАЛНИ <i>SOCKET SET SCHUKO DOUBLE HORIZ</i>	2x 2P+E 16A 250V~ IP44	<input type="checkbox"/> PW бял-матов <i>white-mat</i>
CF11	КОМПЛЕКТ КОНТАКТИ ШУКО ДВОЙНИ ВЕРТИКАЛНИ <i>SOCKET SET SCHUKO DOUBLE VERT</i>	2x 2P+E 16A 250V~ IP44	<input checked="" type="checkbox"/> GY сив-матов <i>grey-mat</i>
CF12	КОМПЛЕКТ КОНТАКТИ ШУКО ДВОЙНИ ВЕРТИКАЛНИ <i>SOCKET SCH+SWITCH 2WAY HORIZ</i>	16A + 10A 250V~ IP44	
⋮	⋮	⋮	
⋮	⋮	⋮	



- CF10PW
 CF10GY

КОМПЛЕКТ КОНТАКТИ ШУКО ДВОЙНИ ХОРИЗОНТАЛНИ IP44 2x 2P+E 16A 250V~

- винтови контакти 1,5 - 2,5 mm²
- 2x 2P+E шуко+капак хоризонтални
- 16A 250 V~, тип CF10
- в съответствие с EN 60884-1, CEE7

SOCKET SET SCHUKO DOUBLE HORIZONTAL IP44 2x 2P+E 16A 250V~
- screw contacts 1.5-2.5mm²
- 2x 2P+E schuko+cover horizontal
- 16A 250V~, type CF10
- in accordance with EN 60884-1, CEE7



- CF11PW
 CF11GY

КОМПЛЕКТ КОНТАКТИ ШУКО ДВОЙНИ ВЕРТИКАЛНИ IP44 2x 2P+E 16A 250V~

- винтови контакти 1,5 - 2,5 mm²
- 2x 2P+E шуко+капак вертикални
- 16A 250 V~, тип CF11
- в съответствие с EN 60884-1, CEE7

SOCKET SET SCHUKO DOUBLE VERTICAL IP44 2x 2P+E 16A 250V~
- screw contacts 1.5-2.5mm²
- 2x 2P+E schuko+cover vertical
- 16A 250V~, type CF11
- in accordance with EN 60884-1, CEE7



- CF12PW
 CF12GY

КОМПЛЕКТ КОНТАКТ ШУКО+КЛЮЧ ХОРИЗОНТАЛНИ 2WAY IP44 16A + 10AX 250V~

- винтове (контакта), чрез вкарване на проводниците (ключа) контакти 1,5 - 2,5 mm²
- 2P+E шуко+капак + ключ 2-way хоризонтални
- 16 A + 10AX 250 V~, тип CF12
- в съответствие с EN 60884-1, CEE7, EN 60669-1

SOCKET SCH+SWITCH SET 2WAY HORIZONTAL IP44 16A + 10AX 250V~
- screw (socket), plug-in (switch) contacts 1.5-2.5mm²
- 2P+E schuko+cover + switch 2-way horizontal
- 16A + 10AX 250V~, type CF12
- in accordance with EN 60884-1, CEE7, EN 60669-1



КОМПЛЕКТ КОНТАКТ ШУКО+КЛЮЧ ВЕРТИКАЛНИ IP44 16A + 10AX 250V~



- CF13PW
- CF13GY

- винтове (контакта), чрез вкарване на проводниците (ключа)
- контакти чрез вкарване 1,5 - 2,5 mm²
- 2P+E шуко+капак + ключ 2-way вертикални
- 16 A + 10AX 250 V~, тип CF13
- в съответствие с EN 60884-1, CEE7, EN 60669-1

SOCKET SCH+SWITCH 2WAY SET VERTICAL IP44 16A + 10AX 250V~

- screw (socket), plug-in (switch) contacts 1.5-2.5mm²
- 2P+E schuko+cover + switch 2-way vertical
- 16A + 10AX 250V~, type CF13
- in accordance with EN 60884-1, CEE7, EN 60669-1



КОМПЛЕКТ КОНТАКТИ ШУКО ДВОЙНИ ХОРИЗОНТАЛНИ IP44 2x 2P+E 16A 250V~ BV



- CF14PW
- CF14GY

- BV контакти чрез вкарване 1,5 - 2,5 mm²
- 2x 2P+E шуко+капак хоризонтални
- 16A 250 V~, тип CF14
- в съответствие с EN 60884-1, CEE7

SOCKET SET SCHUKO DOUBLE HORIZONTAL IP44 2x 2P+E 16A 250V~ BV

- BV plug-in contacts 1.5-2.5mm²
- 2x 2P+E schuko+cover horizontal
- 16A 250V~, type CF14
- in accordance with EN 60884-1, CEE7



КОМПЛЕКТ КОНТАКТИ ШУКО ДВОЙНИ ВЕРТИКАЛНИ IP44 2x 2P+E 16A 250V~ BV



- CF15PW
- CF15GY

- BV контакти чрез вкарване 1,5 - 2,5 mm²
- 2x 2P+E шуко+капак вертикални
- 16A 250 V~, тип CF15
- в съответствие с EN 60884-1, CEE7

SOCKET SET SCHUKO DOUBLE VERTICAL IP44 2x 2P+E 16A 250V~ BV

- BV plug-in contacts 1.5-2.5mm²
- 2x 2P+E schuko+cover vertical
- 16A 250V~, type CF15
- in accordance with EN 60884-1, CEE7



КОМПЛЕКТ КОНТАКТ ШУКО+КЛЮЧ ХОРИЗОНТАЛНИ 2WAY IP44 16A + 10AX 250V~ BV



- CF16PW
- CF16GY

- BV контакти чрез вкарване 1,5 - 2,5 mm²
- 2P+E шуко+капак + ключ 2-way хоризонтални
- 16 A + 10AX 250 V~, тип CF16
- в съответствие с EN 60884-1, CEE7, EN 60669-1

SOCKET+SWITCH SET SCH+2WAY HORIZONTAL IP44 16A + 10AX 250V~ BV

- BV plug-in contacts 1.5-2.5mm²
- 2P+E schuko+cover + switch 2-way horizontal
- 16A + 10AX 250V~, type CF16
- in accordance with EN 60884-1, CEE7, EN 60669-1



КОМПЛЕКТ КОНТАКТ ШУКО+КЛЮЧ 2WAY ВЕРТИКАЛНИ IP44 16A + 10AX 250V~ BV



- CF17PW
- CF17GY

- BV контакти чрез вкарване 1,5 - 2,5 mm²
- 2P+E шуко+капак + ключ 2-way вертикални
- 16 A + 10AX 250 V~, тип CF17
- в съответствие с EN 60884-1, CEE7, EN 60669-1

SOCKET SCH+SWITCH 2WAY SET VERTICAL IP44 16A + 10AX 250V~ BV

- BV plug-in contacts 1.5-2.5mm²
- 2P+E schuko+cover + switch 2-way vertical
- 16A + 10AX 250V~, type CF17
- in accordance with EN 60884-1, CEE7, EN 60669-1



П Р И Н А Д Л Е Ж Н О С Т И А Ф

A C C E S S O R I E S

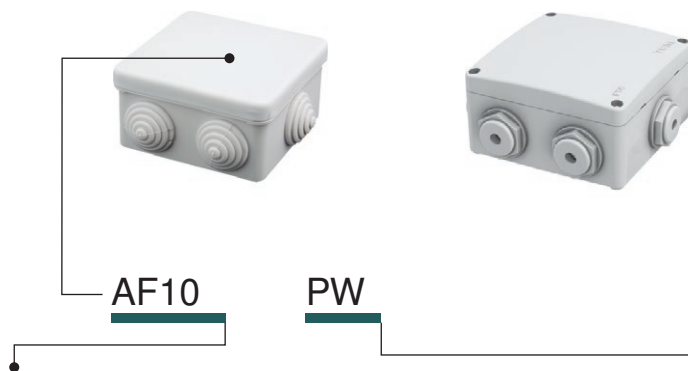

тип type	описание description	технически данни technical data	цвет colour
AF10	РАЗПРЕДЕЛИТЕЛНА КУТИЯ DISTRIBUTION BOX	IP44 RN01	<input type="checkbox"/> PW бял-матов white-mat
AF20	РАЗПРЕДЕЛИТЕЛНА КУТИЯ DISTRIBUTION BOX	IP55 NDO1	<input type="checkbox"/> GY сив-матов grey-mat

РАЗПРЕДЕЛИТЕЛНА КУТИЯ IP44 RN01



- AF10PW
- AF10GY

- разпределителна кутия за външен монтаж IP44
- 16 A 400 V~
- в съответствие с IEC/EN 60670-1, IEC/EN 60670-22

DISTRIBUTION BOX IP44 RN01

- surface mounting distribution box IP44
- 16A 400V~
- in accordance with IEC/EN 60670-1, IEC/EN 60670-22

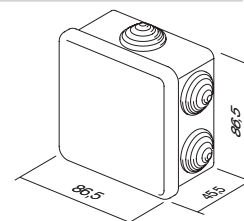

РАЗПРЕДЕЛИТЕЛНА КУТИЯ IP55 ND01



- AF20PW
- AF20GY

- съединителна кутия за външен монтаж IP55
- кабелните щучери са включени в доставката
- в съответствие с IEC/EN 60670-1, IEC/EN 60670-22

DISTRIBUTION BOX IP55 ND01

- surface mounting connection box IP55
- glands included
- in accordance with IEC/EN 60670-1, IEC/EN 60670-22

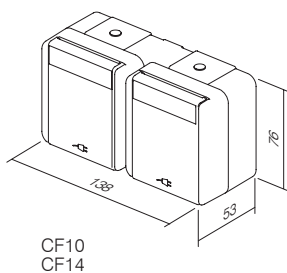
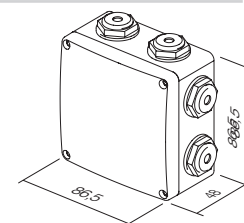

CF10
CF14

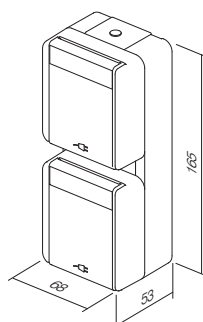

CF11
CF15

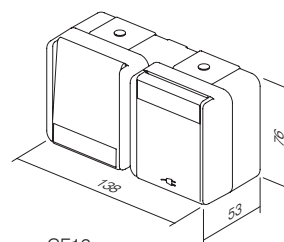

CF12
CF16

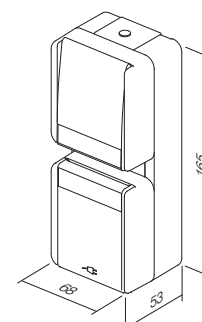

CF13
CF17

код	описание на продукта	страница	код	описание на продукта	страница
КЛЮЧОВЕ SM			КОМУНИКАЦИИ КМ		
SM10	КЛЮЧ 1WAY 16AX 250V~ 1M	38	KM10-	КОНЕКТОР ЗА ТВ ОСНОВЕН 0 dB 1M	52
SM11	БУТОН 1WAY 16A 250V~ 1M	38	KM20-	КОНЕКТОР ЗА ТВ ОСНОВЕН 0 dB 2M	52
SM12	КЛЮЧ 1WAY 20A 250V~ 1M	38	KM11-	КОНЕКТОР ЗА ТВ КРАЕН 1 dB 1M	52
SM20	КЛЮЧ 2POLE 16AX 250V~ 1M	38	KM12-	КОНЕКТОР ЗА ТВ ПРЕХОДЕН 10 dB 1M	52
SM40	КЛЮЧ ЗА ЩОРИ 1-0-2 16AX 250V~ 1M	39	KM15-	КОНЕКТОР ЗА САТЕЛИТНА ТВ ОСНОВЕН 0 dB 1M	53
SM41	БУТОН ЗА ЩОРИ 1-0-2 16A 250V~ 1M	39	KM24-	КОНЕКТОР ЗА САТЕЛИТНА ТВ ОСНОВЕН 0 dB 2M	53
SM60	КЛЮЧ 2WAY 16AX 250V~ 1M	39	KM16-	КОНЕКТОР ЗА САТЕЛИТНА ТВ КРАЕН 1 dB 1M	53
SM61	БУТОН 2WAY 16A 250V~ 1M	39	KM19-	КОНЕКТОР ЗА РАДИО ОСНОВЕН 0 dB 1M	53
SM70	КРЪСТАТ КЛЮЧ 16AX 250V~ 1M	39	KM29-	КОНЕКТОР ЗА РАДИО ОСНОВЕН 0 dB 2M	53
SM10-	КЛЮЧ 1WAY 16AX 250V~ 1M	40	KM25-	КОНЕКТОР ЗА САТЕЛИТНА ТВ КРАЕН 1 dB 2M	53
SM10-IN	КЛЮЧ 1WAY 16AX 250V~ 1M IN	40	KM22-	КОНЕКТОР ЗА АУДИОСИГНАЛИ 2xRCA 1M	54
SM11-	БУТОН 1WAY 16A 250V~ 1M	40	KM23-	КОНЕКТОР ЗА ВИСОКОГОВОРИТЕЛИ 1M	54
SM11-IN01	БУТОН 1WAY 16A 250V~ 1M IN 01	40	KM26-	КОНЕКТОР ЗА ВИСОКОГОВОРИТЕЛИ 2M	54
SM11-IN02	БУТОН 1WAY 16A 250V~ 1M IN 02	41	KM30-	КОНЕКТОР ЗА ТЕЛЕФОН LT RJ11 6/4 1M	55
SM20-NT03	КЛЮЧ 2POLE 16AX 250V~ 1M NT 03	41	KM31-	КОНЕКТОР ЗА ТЕЛЕФОН BT SEC 6/6 1M	55
SM20-IN	КЛЮЧ 2POLE 16AX 250V~ 1M IN	41	KM36-	КОНЕКТОР ЗА ТЕЛЕФОН KS RJ11 6/4 1M	55
SM40-NT10	КЛЮЧ ЗА ЩОРИ 1-0-2 16AX 250V~ 1M NT 10	41	KM37-	КОНЕКТОР CAT5e KS RJ45 8/8 1M	55
SM41-NT10	БУТОН ЗА ЩОРИ1-0-2 16A 250V~ 1M NT 10	41	KM35-	АДАПТЕР KS 1M	55
SM60-	КЛЮЧ 2WAY 16AX 250V~ 1M	41	KM38-	АДАПТЕР KS СЪС ЗАЩИТА ПРОТИВ ПРАХ 1M	55
SM61-	БУТОН 2WAY 16A 250V~ 1M	42	KM39-	КОНЕКТОР CAT6 SCH KS RJ45 8/8 1M	56
SM62-CD	БУТОН 2WAY С ШНУР 16A 250V~ 1M __ CD	42	KM50-	УНИВЕРСАЛЕН АДАПТЕР KS UNIVERSAL 1M	56
SM70-	КРЪСТАТ КЛЮЧ 16AX 250V~ 1M	42	KM40-	АДАПТЕР PD 1M	56
БУТОНИ ТМ			KM43-	АДАПТЕР PD СЪС ЗАЩИТА ПРОТИВ ПРАХ 1M	56
TM11-	БУТОН 1M	43	KM46-	АДАПТЕР R&M 1M	56
TM11-IN	БУТОН 1M IN	43	KM52-	АДАПТЕР R&M CAT6A 1M	56
TM12-	БУТОН 2M	43	KM47-	АДАПТЕР R&M СЪС ЗАЩИТА ПРОТИВ ПРАХ 1M	57
TM12-IN	БУТОН 2M IN	43	KM53-	АДАПТЕР R&M CAT6A СЪС ЗАЩИТА ПРОТИВ ПРАХ 1M	57
TM13-IL	БУТОН 2M С ПАНЕЛ С НАДПИС	44	KM45-	АДАПТЕР LK 1M	58
TM15-	БУТОН 1M 2POLE	44	KA26	АДАПТЕР NEXANS/SCHRACK 2M	58
TM21-	КАПАЧЕ 1M	44	KM48-	АДАПТЕР AT&T SYSTIMAX СЪС ЗАЩИТА ПРОТИВ ПРАХ 1M	58
TM22-	КАПАЧЕ 2M	44	KM51-	КОНЕКТОР USB ТИП А 1M	58
TM31-	ИЗХОД ЗА КАБЕЛ 1M	44	КОМУНИКАЦИОННИ ПРИНАДЛЕЖНОСТИ КА		
ОСВЕТЛЕНИЕ IA			KA10	КОНЕКТОР KS RJ11 RJ11 6/4	59
IA100R	НЕОНОВА ЛАМПА 230 V~ 0,34 W	46	KA11	КОНЕКТОР KS CAT5e RJ45 8/8	59
IA20-	СВЕТОДИОДНА ЛАМПА 230 V AC/DC 0,4W	46	KA12	КОНЕКТОР KS CAT5eS RJ45 8/8	59
IA21-	СВЕТОДИОДНА ЛАМПА 24 V AC/DC 0,2W	46	KA15	КОНЕКТОР KS RJ45 SCHRACK RJ45 8/8	59
IA22-	СВЕТОДИОДНА ЛАМПА 12V AC/DC 0,10W	46	KA16	КОНЕКТОР KS RJ45 SCHRACK RJ45 8/8	59
IA50	RC ВЕРИГА 250 V	46	KA17	КОНЕКТОР KS CAT6a SCHRACK RJ45 8/8	59
КОНТАКТИ VM			KA18	КОНЕКТОР KS RJ45 SCHRACK RJ45 8/8	60
VM10-	КОНТАКТ ШУКО+KS 2P+E 16A 250V~ 2M	48	KA27	КОНЕКТОР KS HDMI	60
VM11-	КОНТАКТ ШУКО+KS+КАПАК 2P+E 16A 250V~ 2M	48	KA28	КАБЕЛ KS HDMI	60
VM20-	КОНТАКТ EURO+KS 2P 10A 250V~ 1M	49	ЕЛЕКТРОНИКА ЕМ		
VM40-	КОНТАКТ ФРЕНСКИ+KS 2P+E 16A 250V~ 2M	49	EM12-	ДИМЕР, ВЪРТЯЩ ТИП/2WAY RL 300W 1M	61
VM41-	КОНТАКТ ФРЕНСКИ+KS+КАПАК 2P+E 16A 250V~ 2M	49	EM13-	ДИМЕР, ВЪРТЯЩ ТИП/2WAY LED 60W 1M	61
VM30-	КОНТАКТ ИТАЛИАНСКИ R17/11+KS 2P+E 16A 250V~ 1M	49	EM14-	ДИМЕР, ВЪРТЯЩ ТИП/2WAY LED 180W 1M	62
VM31-	КОНТАКТ ШУКО/ИТАЛИАНСКИ R17/11+KS 2P+E 16A 250V~ 2M	49	EM15-	ДИМЕР, ВЪРТЯЩ ТИП, R 250W 1M	62
VM32-	КОНТАКТ ШУКО/ИТАЛИАНСКИ R30+KS 2P+E 16A 250V~ 2M	50	EM16-	1 - 10 V ДИМЕР, ВЪРТЯЩ ТИП, ДВУПОСОЧЕН	62
VM33-	КОНТАКТ ИТАЛИАНСКИ R11+KS 2P+E 10A 250V~ 1M	50	EM23	ДИМЕР, ВГРАДЕН R (250 W), (RC, RL 200VA)	63
VM21-	КОНТАКТ EURO/АМЕРИКАНСКИ+KS 2P 16A 250V~ 1M	50	EM18	ДИМЕРНО УСТРОЙСТВО ЗА СВЕТОДИОДИ 250W	63
VM52-	КОНТАКТ БРИТАНСКИ BS 1363+KS 2P+E 13A 250V~ 2M	50	EM19	ДИМЕРНО УСТРОЙСТВО ЗА СВЕТОДИОДИ, ПОСТОЯНЕН ТОК 96 W	63
VM55-	КОНТАКТ МУЛТИСТАНДАРТИЯТ+KS 2P+E 13A 250V~ 2M	50	EM25-	КЛЮЧ/УНИВЕРСАЛЕН ДИМЕР RLC 0-300W 2M	65
VM80	УСТРОЙСТВО ЗА ЗАЩИТА СРЕЩУ ОТСКОЦИ НА НАПРЕЖЕНИЕТО MPE MINI 275V/50Hz	80	EM26-	БУТОННО УСТРОЙСТВО ЗА УПРАВЛЕНИЕ 2M	67
			EM27	ЧЕСТОТЕН ФИЛТЪР	67
			EM25PPOL20	КОМПЛЕКТ КЛЮЧ/УНИВЕРСАЛЕН ДИМЕР RLC 0-300W 2M PP OL20	67
			EM31-	КЛЮЧ IR SWITCH 5A 230V~ 1M	68
			EM32-	КЛЮЧ IR SWITCH 5A 230V~ 2M	68
			EM37-	КЛЮЧ ОСНОВЕН 6A 230 V~ 2M	70
			EM38-	ТЕРМОСТАТ ЗА ОТОПЛЕНИЕ 5(2) A 230 V~ 2M	71
			EM39	ТЕРМОСТАТ ЗА ОТОПЛЕНИЕ/ОХЛАЖДАНЕ 3(1,5) A 230 V~ 2M	71
			NM39	МОНТАЖНА РАМКА С ВИНТОВЕ ЗА ТЕРМОСТАТИ FANTINI COSMI 3M	72
			EM40-	КЛЮЧ С КАРТА ЗА ИКОНОМИЯ НА ЕНЕРГИЯ ЗА 250V~ 3M	72
			EM47	ISO КАРТА	72
			EM44-	КЛЮЧ С КАРТА ЗА ИКОНОМИЯ НА ЕНЕРГИЯ RF HF 13,56 MGz 3M	73
			EM49	УСТРОЙСТВО ЗА УПРАВЛЕНИЕ ЗА ИКОНОМИЯ НА ЕНЕРГИЯ 2x16A 250V~	73
			EM45	РАЗПРЕДЕЛИТЕЛ SPL-1	73
			EM60-	КОНТАКТ ЗА САМОБЪРСНАЧКА 230V~/120V~ 3M	74
			EM67-	USB ЗАХРАНВАЩО УСТРОЙСТВО 5 V 2,4 A 1M	74
			EM68-	USB ЗАХРАНВАЩ БЛОК 5V 3,0A	75
			EM55	СВЕТОДИОДНО АВАРИЙНО ОСВЕТЛЕНИЕ 250 V~ 0,90 W, NiCd 3h 7M	75
			EM57	АВАРИЙНА СВЕТОДИОДНА ЛАМПА 230V~50 Hz, 0,5 W, NiMH 2h 2M	75
			EM50-	ЕДНОЦВЕТНА СВЕТОДИОДНА ЛАМПА 250V~ 0,8W 2M	75
			EM51-	ДВУЦВЕТНА СВЕТОДИОДНА ЛАМПА 250V~ 2x0,4W 2M	76
			EM52-	ДВУЦВЕТНА СВЕТОДИОДНА ЛАМПА 3D 250V~ 2x0,4W 2M	76
			EM71-	ПРЕВКЛЮЧАТЕЛ С ПРЪСТОВ ОТПЕЧАТЪК BIOPASS 2M	77
			EM80-	БЕЗКОНТАКТЕН КЛЮЧ, 10 A 240 V~	78
			EM81-	БЕЗКОНТАКТЕН КЛЮЧ	78
			EM91-	ЗУМЕР 8VA 12V~ 1M	79
			EM93-	ЗУМЕР 8VA 12V~ 1M	79
			EM94-	CSENGO 230V~ 6mA rms 1M	79
			EM95-	РЕГУЛАТОР НА СИЛАТА НА ЗВУКА 100V AUDIO LINE 35W 2M	80
			EM96-	РЕГУЛАТОР НА СИЛАТА НА ЗВУКА 4 - 8 Ω 35 W 2M	80

код	описание на продукта	страница	код	описание на продукта	страница
КОМПЛЕКТИ СМ			КУТИИ		
SM10-	КОМПЛЕКТ КОНТАКТИ 2 x ШУКО 2P+E 16A 250V~ 4M	81	КРЪГЛИ КОНЗОЛИ		
SM11-	КОМПЛЕКТ КОНТАКТИ 3 x ШУКО 2P+E 16A 250V~ 7M	81	DE10	КРЪГЛА КОНЗОЛА ЗА ТУХЛЕНИ СТЕНИ SM60-01	110
SM15	КОМПЛЕКТ СЪЕДИНИТЕЛНИ ПРОВОДНИЦИ 3x1,5 mm2 1M	82	DE11	КРЪГЛА КОНЗОЛА ЗА ТУХЛЕНИ СТЕНИ, ДЪЛБОКА SM60-06	110
SM16	КОМПЛЕКТ СЪЕДИНИТЕЛНИ ПРОВОДНИЦИ 3x2,5 mm2 2M	82	DE30	СОМБИ-CLIP SM60-03	110
SM17	КОМПЛЕКТ ВИНТОВЕ 3.5x20	82	DE31	СОМБИ-CLIP SM60-04	110
SM18	КОМПЛЕКТ ВИНТОВЕ 3.5x35	82	DE12	КРЪГЛА КОНЗОЛА ЗА ТУХЛЕНИ СТЕНИ 65-46	111
SM19	КОМПЛЕКТ ВИНТОВЕ 3.5x50	82	DE13	КРЪГЛА КОНЗОЛА ЗА ТУХЛЕНИ СТЕНИ 65-60	111
SM22-	КОМПЛЕКТ КЛЮЧОВЕ IP44 2M	82	DE14	ДОПЪЛНИТЕЛЕН ДЕТАЙЛ ЗА MD 65-46	111
SM23-	КОМПЛЕКТ КОНТАКТИ IP44 2M	82	DE32	СОМБИ-CLIP MD 65-71	111
SM25-OL	КОМПЛЕКТ КЛЮЧ ЗА БАНЯ 3 x 20A 250 V~ 4M OL	82	DE33	СОМБИ-CLIP MD 65-91	111
SM25-OS	КОМПЛЕКТ КЛЮЧ ЗА БАНЯ 3 x 20A 250 V~ 4M OS	82	DE20	ЗАЩИТЕН КАПАК ЗА КОНЗОЛА 60	111
NM41	МОНТАЖНА РАМКА ЗА КОМПЛЕКТ ЗА БАНЯ 4M	83	DE21	ЗАЩИТЕН КАПАК ЗА КОНЗОЛА 65	111
OL41-	ПАНЕЛ LINE ЗА КОМПЛЕКТ ЗА БАНЯ	83	DE22	ДЕКОРАТИВЕН КАПАК ЗА КОНЗОЛА SM60	111
OS41-	ПАНЕЛ SOFT ЗА КОМПЛЕКТ ЗА БАНЯ	83	HE10	КРЪГЛА КОНЗОЛА ЗА ТУХЛЕНИ СТЕНИ SM68x40	114
АНТИБАКТЕРИАЛНА ПРОГРАМА AW			HE11	КРЪГЛА КОНЗОЛА ЗА ТУХЛЕНИ СТЕНИ SM68x55	114
TM11AW	БУТОН 1M	85	BE10	КРЪГЛА КОНЗОЛА ЗА СТЕНИ ОТ БЕТОН 60-49	114
TM11AWIN	БУТОН 1M IN	85	BE11	КРЪГЛА КОНЗОЛА ЗА СТЕНИ ОТ БЕТОН 60-77	114
TM12AW	БУТОН 2M	85	BE20	ЗАДНА ОПОРА ЗА КОНЗОЛА ЗА СТЕНИ ОТ БЕТОН	114
TM12AWIN	БУТОН 2M IN	85	BE21	ОГРАНИЧИТЕЛ ЗА ТРЪЧИ ЗА КОНЗОЛИ ЗА СТЕНИ ОТ БЕТОН 16	114
TM21AW	КАПАЧЕ 1M	85	ПРАВОЪГЪЛНИ КОНЗОЛИ		
TM22AW	КАПАЧЕ 2M	85	DM30	ПРАВОЪГЪЛНА КОНЗОЛА ЗА ТУХЛЕНИ СТЕНИ PM3	118
VM10AW	КОНТАКТ ШУКО+KS 2P+E 16A 250V~ 2M	86	DM31	ПРАВОЪГЪЛНА КОНЗОЛА ЗА ТУХЛЕНИ СТЕНИ PM3-65	118
VM11AW	КОНТАКТ ШУКО+KS+КАПАК 2P+E 16A 250V~ 2M	86	DM40	ПРАВОЪГЪЛНА КОНЗОЛА ЗА ТУХЛЕНИ СТЕНИ PM4	118
VM20AW	КОНТАКТ EURO+KS 2P 10A 250V~ 1M	86	DM41	ПРАВОЪГЪЛНА КОНЗОЛА ЗА ТУХЛЕНИ СТЕНИ PM4-65	118
KM11AW	КОНЕКТОР ЗА ТВ КРАЕН 1 dB 1M	86	DM70	ПРАВОЪГЪЛНА КОНЗОЛА ЗА ТУХЛЕНИ СТЕНИ PM7	119
KM35AW	АДАПТЕР KS 1M	86	DM71	ПРАВОЪГЪЛНА КОНЗОЛА ЗА ТУХЛЕНИ СТЕНИ PM7-65	119
OS20AW	ПАНЕЛ SOFT 2M	87	DM72	ПРАВОЪГЪЛНА КОНЗОЛА ЗА ТУХЛЕНИ СТЕНИ PM72-65	119
OS24AW	ПАНЕЛ SOFT 2x2M	87	DM80	ДИСТАНЦИОНЕН ЕЛЕМЕНТ ЗА КОНЗОЛА PM	119
OS26AW	ПАНЕЛ SOFT 3x2M	87	DM33	ЗАЩИТЕН КАПАК ЗА КОНЗОЛА PM3	120
OS30AW	ПАНЕЛ SOFT 3M	87	DM34	ДЕКОРАТИВЕН КАПАК ЗА КОНЗОЛА PM3	120
OS40AW	ПАНЕЛ SOFT 4M	87	DM43	ЗАЩИТЕН КАПАК ЗА КОНЗОЛА PM4	120
OS70AW	ПАНЕЛ SOFT 7M	87	DM44	ДЕКОРАТИВЕН КАПАК ЗА КОНЗОЛА PM4	120
ПАНЕЛИ PURE OP			DM73	ЗАЩИТЕН КАПАК ЗА КОНЗОЛА PM7	120
OP20-	ПАНЕЛ PURE 2M	90	DM74	ДЕКОРАТИВЕН КАПАК ЗА КОНЗОЛА PM7	120
OP24-	ПАНЕЛ PURE 2x2M	90	DM75	ДЕКОРАТИВЕН КАПАК ЗА КОНЗОЛА PM72	121
OP26-	ПАНЕЛ PURE 3x2M	90	NM30	ПРАВОЪГЪЛНА КОНЗОЛА ЗА КУХИ СТЕНИ VM3	122
OP28-	ПАНЕЛ PURE 4x2M	90	NM40	ПРАВОЪГЪЛНА КОНЗОЛА ЗА КУХИ СТЕНИ VM4	122
OP30-	ПАНЕЛ PURE 3M	91	NM70	ПРАВОЪГЪЛНА КОНЗОЛА ЗА КУХИ СТЕНИ VM7	122
OP40-	ПАНЕЛ PURE 4M	91	NM72	ПРАВОЪГЪЛНА КОНЗОЛА ЗА КУХИ СТЕНИ VM72	122
OP70-	ПАНЕЛ PURE 7M	91	VM30	ПРАВОЪГЪЛНА КОНЗОЛА ЗА СТЕНИ ОТ БЕТОН VM3	123
OP13-	ПАНЕЛ PURE 1/3M	91	VM40	ПРАВОЪГЪЛНА КОНЗОЛА ЗА СТЕНИ ОТ БЕТОН VM4	123
OP23-	ПАНЕЛ PURE 2/3M	91	VM70	ПРАВОЪГЪЛНА КОНЗОЛА ЗА СТЕНИ ОТ БЕТОН VM7	123
ПРОДУКТОВА ГАМА ПАНЕЛИ OL			VM80	FIXING COMBI-CLIP VM	123
OL20-	ПАНЕЛ LINE 2M	94	VM82	ДИСТАНЦИОНЕН ЕЛЕМЕНТ ЗА КОНЗОЛИ VM	123
OL24-	ПАНЕЛ LINE 2x2M	94	СЪЕДИНИТЕЛНИ КУТИИ		
OL26-	ПАНЕЛ LINE 3x2M	94	DW10	КРЪГЛА СЪЕДИНИТЕЛНА КОНЗОЛА ЗА ТУХЛЕНИ СТЕНИ DSM78	126
OL28-	ПАНЕЛ LINE 4x2M	94	NW10	КРЪГЛА СЪЕДИНИТЕЛНА КОНЗОЛА ЗА КУХИ СТЕНИ SM78x45	126
OL29-	ПАНЕЛ LINE 5x2M	94	DE23	ДЕКОРАТИВЕН КАПАК ЗА КОНЗОЛА SM78	126
OL30-	ПАНЕЛ LINE 3M	95	DE24	ЗАЩИТЕН КАПАК ЗА КОНЗОЛА 78	126
OL40-	ПАНЕЛ LINE 4M	95	NW20	КВАДРАТНА СЪЕДИНИТЕЛНА КОНЗОЛА ЗА ТУХЛЕНИ СТЕНИ SM105x105	126
OL70-	ПАНЕЛ LINE 7M	95	ПРИНАДЛЕЖНОСТИ ЗА СВЪРЗВАНЕ		
OL10-	ПАНЕЛ LINE 1/2M	95	UW10-	1 РЕД КЛЕМОРЕДИ ЗАТВОРЕНИ PC 2x2,5 mm ² 10P	128
OL13-	ПАНЕЛ LINE 1/3M	95	UW11-	1 РЕД КЛЕМОРЕДИ ЗАТВОРЕНИ PC 2x4 mm ² 10P	128
OL23-	ПАНЕЛ LINE 2/3M	95	UW12-	1 РЕД КЛЕМОРЕДИ ЗАТВОРЕНИ PC 2x6 mm ² 10P	128
ПАНЕЛИ SOFT OS			UW15-	1 РЕД КЛЕМОРЕДИ PA 2x2,5 mm ² 12P	128
OS20-	ПАНЕЛ SOFT 2M	98	UW16-	1 РЕД КЛЕМОРЕДИ PA 2x4 mm ² 12P	128
OS24-	ПАНЕЛ SOFT 2x2M	98	UW17-	1 РЕД КЛЕМОРЕДИ PA 2x6 mm ² 12P	128
OS26-	ПАНЕЛ SOFT 3x2M	98	UW29-	2 РЕДА КЛЕМОРЕДИ PP 1,0-4,0 mm ² 12P	128
OS28-	ПАНЕЛ SOFT 4x2M	98	UW30-	2 РЕДА КЛЕМОРЕДИ PP 1,5-6,0 mm ² 12P	128
OS30-	ПАНЕЛ SOFT 3M	99	UW31-	2 РЕДА КЛЕМОРЕДИ PP 2,5-10 mm ² 12P	128
OS40-	ПАНЕЛ SOFT 4M	99	UW32-	2 РЕДА КЛЕМОРЕДИ PP 4,0-16 mm ² 12P	128
OS70-	ПАНЕЛ SOFT 7M	99	UW25-	2 РЕДА КЛЕМОРЕДИ PA 1,0-4,0 mm ² 12P	129
OS72-	ПАНЕЛ SOFT 2x7M	99	UW26-	2 РЕДА КЛЕМОРЕДИ PA 1,5-6,0 mm ² 12P	129
OS10-	ПАНЕЛ SOFT 1/2M	99	UW27-	2 РЕДА КЛЕМОРЕДИ PA 2,5-10 mm ² 12P	129
OS13-	ПАНЕЛ SOFT 1/3M	99	UW28-	2 РЕДА КЛЕМОРЕДИ PA 4,0-16 mm ² 12P	129
OS23-	ПАНЕЛ SOFT 2/3M	99	UW40-	СЪЕДИНИТЕЛИ С ВКАРВАНЕ НА ПРОВОДНИЦИТЕ PA 1,5 mm ² 3P	129
МОНТАЖНИ РАМКИ NM			UW41-	СЪЕДИНИТЕЛИ С ВКАРВАНЕ НА ПРОВОДНИЦИТЕ PA 1,5 mm ² 5P	129
NM20	МОНТАЖНА РАМКА С КРАЧЕТА 2M	104	UW42-	СЪЕДИНИТЕЛИ С ВКАРВАНЕ НА ПРОВОДНИЦИТЕ PA 1,5 mm ² 8P	129
NM21	МОНТАЖНА РАМКА БЕЗ ВИНТОВЕ 2M	104	UW45-	СЪЕДИНИТЕЛИ С ВКАРВАНЕ НА ПРОВОДНИЦИТЕ PA 2,5 mm ² 3P	129
NM24	МЕТАЛНА МОНТАЖНА РАМКА С КРАЧЕТА 2M	104	UW46-	СЪЕДИНИТЕЛИ С ВКАРВАНЕ НА ПРОВОДНИЦИТЕ PA 2,5 mm ² 4P	129
NM25	МЕТАЛНА МОНТАЖНА РАМКА БЕЗ ВИНТОВЕ 2M	104	UW47-	СЪЕДИНИТЕЛИ С ВКАРВАНЕ НА ПРОВОДНИЦИТЕ PA 2,5 mm ² 5P	129
NM30	МЕТАЛНА МОНТАЖНА РАМКА С ВИНТОВЕ 3M	105	UW50-	СЪЕДИНИТЕЛИ С ВКАРВАНЕ НА ПРОВОДНИЦИТЕ PA 2,5 mm ² 2/1P	129
NM40	МЕТАЛНА МОНТАЖНА РАМКА С ВИНТОВЕ 4M	105			
NM70	МЕТАЛНА МОНТАЖНА РАМКА С ВИНТОВЕ 7M	105			
NM72	МЕТАЛНА МОНТАЖНА РАМКА С ВИНТОВЕ 2x7M	105			
NM10	МОНТАЖНА РАМКА С КРАЧЕТА 1/2M	106			
NM11	МОНТАЖНА РАМКА БЕЗ ВИНТОВЕ 1/2M	106			
NM23	МОНТАЖНА РАМКА С КРАЧЕТА 2/3M	106			
NM32	МЕТАЛНА МОНТАЖНА РАМКА С ВИНТОВЕ 2/3M	106			

код	описание на продукта	страница
КОНЗОЛИ СУВО IP20 AC		
AC11-	КОНЗОЛА NO СУВО СЪС ЗАДЕН КАПАК IP20 1M	132
AC21-	КОНЗОЛА NO СУВО СЪС ЗАДЕН КАПАК IP20 2M	132
AC41-	КОНЗОЛА NO СУВО СЪС ЗАДЕН КАПАК IP20 4M	132
AC61-	КОНЗОЛА NO СУВО СЪС ЗАДЕН КАПАК IP20 6M	132
КОНЗОЛИ СУВО IP55 AQ		
AQ20-	КОНЗОЛА NO СУВО IP55 2M	133
AQ22-	КОНЗОЛА NO СУВО IP55 2x2M	133
AQ30-	КОНЗОЛА NO СУВО IP55 3M	133
AQ21-	КУТИЯ PO СУВО IP55 2M	134
AQ31-	КОНЗОЛА PO СУВО IP55 3M	134
СИСТЕМА ЗА КАНАЛ ЗА КАБЕЛИ МА		
RT10	АДАПТЕР МА 162	135
RT12-	ПАНЕЛ МА 92 2/3M	135
RT14-	ПАНЕЛ МА 162 4M	135
RT17-	ПАНЕЛ МА 162 7M	135
RT20-	ОСНОВА ЗА КАНАЛ МА 130x65	136
RT21-	ОСНОВА ЗА КАНАЛ МА 165x65	136
RT25	ПРЕДЕН КАПАК МА 92	136
RT30	КАБЕЛНА СКАРА МА 43	136
RT31	КАБЕЛНА СКАРА МА 43 AL	136
RT32	КАБЕЛНА СКАРА МА 43 AL ДВОЙНА	136
RT35-	КРАЕН ЕЛЕМЕНТ МА 130x65	137
RT36-	КРАЕН ЕЛЕМЕНТ МА 165x65	137
RT38	КОМПЛЕКТ СЪЕДИНИТЕЛЕН ЕЛЕМЕНТ МА 65	137
RT40-	УНИВЕРСАЛЕН ЪГЛОВ ЕЛЕМЕНТ МА 130x65	137
RT41-	УНИВЕРСАЛЕН ЪГЛОВ ЕЛЕМЕНТ МА 165x65	137
RT42	ЗАЗЕМИТЕЛЕН ЕЛЕМЕНТ МА 2x A6.3	137
RT43-	ЛКОЛЯНО МА 130x65	138
RT44-	ЛКОЛЯНО МА 165x65	138
RT45-	ТКОЛЯНО МА 130x65	138
RT46-	ТКОЛЯНО МА 165x65	138
RT50-	ЕДИНИЧНА ЗАКРЕПВАЩА ПЛАСТИНА МА 130x65	139
RT51-	ДВОЙНА ЗАКРЕПВАЩА ПЛАСТИНА МА 130x65	139
RT52-	СЕРВИЗНА КОЛОНА МА 130x65x500	139
RT53-	ДВОЙНА СЕРВИЗНА КОЛОНА МА 130x65x500	139
ПОДОВИ КОНЗОЛИ МТ		
RB50	ОСНОВА ЗА ПОДОВА КОНЗОЛА 4M	141
RB60	ВЛОЖКА ЗА ПОДОВА РАЗПРЕДЕЛИТЕЛНА КОНЗОЛА 4M	141
RB65S1	КАПАК ЗА ПОДОВА РАЗПРЕДЕЛИТЕЛНА КОНЗОЛА 4M	141
RB51	ОСНОВА ЗА ПОДОВА КОНЗОЛА 7M	141
RB61	ВЛОЖКА ЗА ПОДОВА РАЗПРЕДЕЛИТЕЛНА КОНЗОЛА 7M	141
RB66S1	КАПАК ЗА ПОДОВА РАЗПРЕДЕЛИТЕЛНА КОНЗОЛА 7M	141
RB52	ОСНОВА ЗА ПОДОВА КОНЗОЛА 2X7M	142
RB62	ВЛОЖКА ЗА ПОДОВА РАЗПРЕДЕЛИТЕЛНА КОНЗОЛА 2X7M	142
RB67S2	КАПАК ЗА ПОДОВА РАЗПРЕДЕЛИТЕЛНА КОНЗОЛА 2X7M	142
RB53	ОСНОВА ЗА ПОДОВА КОНЗОЛА 4X7M	142
RB62	ВЛОЖКА ЗА ПОДОВА РАЗПРЕДЕЛИТЕЛНА КОНЗОЛА 2X7M	142
RB68S2	КАПАК ЗА ПОДОВА РАЗПРЕДЕЛИТЕЛНА КОНЗОЛА 4X7M	142
RB55S1	ПОДОВА КОНЗОЛА С КАПАК ЗА ДВОЕН ПОД 4M	143
RB60	ВЛОЖКА ЗА ПОДОВА РАЗПРЕДЕЛИТЕЛНА КОНЗОЛА 4M	143
RB56S1	ПОДОВА КОНЗОЛА С КАПАК ЗА ДВОЕН ПОД 7M	144
RB61	ВЛОЖКА ЗА ПОДОВА РАЗПРЕДЕЛИТЕЛНА КОНЗОЛА 7M	144
RB57S2	ПОДОВА КОНЗОЛА С КАПАК ЗА ДВОЕН ПОД 2X7M	144
RB62	ВЛОЖКА ЗА ПОДОВА РАЗПРЕДЕЛИТЕЛНА КОНЗОЛА 2X7M	144
RB58S2	ПОДОВА КОНЗОЛА С КАПАК ЗА ДВОЕН ПОД 4X7M	144
RB62	ВЛОЖКА ЗА ПОДОВА РАЗПРЕДЕЛИТЕЛНА КОНЗОЛА 2X7M	145
RB10	АДАПТЕР ЗА DIN РЕЛСА 35mm 1M	145
RB11	АДАПТЕР ЗА DIN РЕЛСА 35mm 2M	145

код	описание на продукта	страница
КЛЮЧОВЕ SQ		
SQ10-XO	КЛЮЧ 1WAY 10AX 250V~	158
SQ10-INXO	КЛЮЧ 1WAY 10AX 250V~ __ IN	158
SQ11-XO	БУТОН 1WAY 10A 250V~	158
SQ11-IN01XO	БУТОН 1WAY 10A 250V~ __ IN 01	158
SQ11-IN02XO	БУТОН 1WAY 10A 250V~ __ IN 02	159
SQ22-IN03XO	КЛЮЧ 2POLE 16AX 250V~ __ IN 03	159
SQ50-XO	КЛЮЧ 2GANG-1WAY 10AX 250V~	159
SQ51-XO	БУТОН 2GANG-1WAY 10A 250V~	159
SQ52-NT09XO	КЛЮЧ ЗА ЩОРИ 10AX 250V~ __ NT 09	159
SQ53-NT09XO	БУТОН ЗА ЩОРИ 10A 250V~ __ NT 09	159
SQ60-XO	КЛЮЧ 2WAY 10AX 250V~	159
SQ63-XO	ДВОЕН КЛЮЧ 2WAY 10AX 250V~	160
SQ70-XO	КРЪСТАТ КЛЮЧ 10AX 250V~	160
ОСВЕТЛЕНИЕ IA		
IA10-	НЕОНОВА ЛАМПА 230 V~ 0,34 W	161
IA20-	СВЕТОДИОДНА ЛАМПА 230V ~ AC/DC 0,4W	161
IA21-	СВЕТОДИОДНА ЛАМПА 24 V AC/DC 0,2W	161
IA22-	СВЕТОДИОДНА ЛАМПА 12 V AC/DC 0,1W	161
КОНТАКТИ VQ		
VQ10-XO	КОНТАКТ ШУКО 2P+E 16A 250V~ __ XO	164
VQ11-XO	КОНТАКТ ШУКО+КАПАК 2P+E 16A 250V~ __ XO	164
VQ12-XO	КОНТАКТ ШУКО 2P+E 16A 250V~ BV __ XO	164
VQ13-XO	КОНТАКТ ШУКО+КАПАК 2P+E 16A 250V~ BV __ XO	164
VQ16-	КОНТАКТ ШУКО ДВОЕН 2P+E 16A 250V~	164
КОМУНИКАЦИИ KQ		
KQ10-XO	КОНТАКТ ЗА ТВ БА30В 0 dB	165
KQ11-XO	КОНТАКТ ЗА ТВ-РАДИО КРАЕН 1 dB	165
KQ12-XO	КОНТАКТ ЗА ТВ-РАДИО ПРЕХОДЕН 10 dB	165
KQ16-XO	КОНТАКТ ЗА САТЕЛИТНА ТВ-РАДИО КРАЕН 3 dB	165
KQ22-XO	КОНТАКТ ЗА АУДИОСИГНАЛИ 2xRCA	166
KQ23-XO	КОНТАКТ ЗА ВИСОКОГОВОРИТЕЛИ	166
KQ36-XO	КОНЕКТОР ЗА ТЕЛЕФОН KS RJ11 6/4	166
KQ37-XO	КОНЕКТОР CAT5e KS RJ45 8/8	166
KQ38-XO	КОНЕКТОР ЗА ТЕЛЕФОН KS ДВОЕН 2x RJ11 6/4	166
KQ39-XO	КОНЕКТОР CAT5e KS ДВОЕН 2x RJ45 8/8	166
KQ35-XO	КОНЕКТОР ЗА ТЕЛЕФОН LT RJ11 6/4	166
KQ40-XO	КОНЕКТОР CAT6s KS ДВОЕН 2x RJ45 8/8 SLIM	167
KQ41-XO	КОНЕКТОР CAT6s KS ДВОЕН 2x RJ45 8/8 SLIM	167
ЕЛЕКТРОНИКА EQ		
EQ15-XO	ДИМЕР, ВЪРТЯЩ ТИП, ДВУПОСОЧЕН, АКТИВЕН/ИНДУКТИВЕН ТОВАР 400W	168
EQ16-XO	ДИМЕР, ВЪРТЯЩ ТИП, ДВУПОСОЧЕН, АКТИВЕН/ИНДУКТИВЕН/КАПАЦИТИВЕН ТОВАР 400W	168
EQ19-XO	ДИМЕР, ВЪРТЯЩ ТИП, ДВУПОСОЧЕН, ЗА СВЕТОДИОДНО ОСВЕТЛЕНИЕ 100W	168
EQ32-XO	КЛЮЧ IR 5A 230V~	170
EQ35-XO	ОТОПЛЕНИЕ С ТЕРМОСТАТ 10A 230V~	170
EQ36-XO	ОТОПЛЕНИЕ/ОХЛАЖДАНЕ С ТЕРМОСТАТ 5A 230V~	170
EQ37-XO	ПОДОВО ОТОПЛЕНИЕ С ТЕРМОСТАТ 16A 230V~	171
EQ68-	USB ЗАХРАНВАЩО УСТРОЙСТВО 5V 3.0A	171
КАПАЦИ PQ		
PQ10-XO	КАПАЧЕ	172
PQ30-	ПАНЕЛ TAE/TDO	172
РАМКИ OQ		
OQ10-	ПАНЕЛ LOGIQ 1	173
OQ20-	ПАНЕЛ LOGIQ 2	173
OQ30-	ПАНЕЛ LOGIQ 3	174
OQ40-	ПАНЕЛ LOGIQ 4	174
OQ50-	ПАНЕЛ LOGIQ 5	174

код	описание на продукта	страница
КЛЮЧОВЕ SE		
SE10	КЛЮЧ 1WAY 10AX 250V~	186
SE11	БУТОН 1WAY 10A 250V~	186
SE22	КЛЮЧ 2POLE 16AX 250V~	186
SE50	КЛЮЧ 2GANG-1WAY 10AX 250V~	186
SE51	БУТОН 2GANG-1WAY 10A 250V~	187
SE52	КЛЮЧ ЗА ЩОРИ 10AX 250V~	187
SE53	БУТОН ЗА ЩОРИ 10A 250V~	187
SE60	КЛЮЧ 2WAY 10AX 250V~	187
SE63	ДВОЕН КЛЮЧ 2WAY 10AX 250V~	187
SE70	КРЪСТАТ КЛЮЧ 10AX 250V~	187
SE10-	КЛЮЧ 1WAY 10AX 250V~	188
SE10-IN	КЛЮЧ 1WAY 10AX 250V~ IN	188
SE11-	БУТОН 1WAY 10A 250V~	188
SE11-TI50	БУТОН 1WAY 10A 250V~ TI 50	188
SE11-TI51	БУТОН 1WAY 10A 250V~ TI 51	188
SE11-IL	БУТОН 1WAY 10A 250V~ IL	188
SE22-IN03	КЛЮЧ 2POLE 16AX 250V~ IN 03	188
SE50-	КЛЮЧ 2GANG-1WAY 10AX 250V~	189
SE51-	БУТОН 2GANG-1WAY 10A 250V~	189
SE52-NT09	КЛЮЧ ЗА ЩОРИ 10AX 250V~ NT 09	189
SE53-NT09	БУТОН ЗА ЩОРИ 10A 250V~ NT 09	189
SE60-	КЛЮЧ 2WAY 10AX 250V~	189
SE63-	ДВОЕН КЛЮЧ 2WAY 10AX 250V~	189
SE70-	КРЪСТАТ КЛЮЧ 10AX 250V~	189
БУТОНИ ТЕ		
TE10-	БУТОН 1GANG	190
TE10-IN	БУТОН С ИНДИКАТОР	190
TE13-IL	БУТОН С ПАНЕЛ С НАДПИС IL	190
TE11-	БУТОН 2GANG	190
ОСВЕТЛЕНИЕ IA		
IA10-	НЕОНОВА ЛАМПА 230 V~ 0,34 W	191
IA20-	СВЕТОДИОДНА ЛАМПА 230V ~ AC/DC 0,4W	191
IA21-	СВЕТОДИОДНА ЛАМПА 24 V AC/DC 0,2W	191
IA22-	СВЕТОДИОДНА ЛАМПА 12 V AC/DC 0,1W	191
КОНТАКТИ VE		
VE10-XO	КОНТАКТ ШУКО 2P+E 16A 250V~ XO	194
VE11-XO	КОНТАКТ ШУКО+КАПАК 2P+E 16A 250V~ XO	194
VE12-XO	КОНТАКТ ШУКО 2P+E 16A 250V~ BV XO	194
VE13-XO	КОНТАКТ ШУКО+КАПАК 2P+E 16A 250V~ BV XO	194
VE10-	КОНТАКТ ШУКО 2P+E 16A 250V~	194
VE11-	КОНТАКТ ШУКО+КАПАК 2P+E 16A 250V~	194
VE12-	КОНТАКТ ШУКО 2P+E 16A 250V~ BV	194
VE13-	КОНТАКТ ШУКО+КАПАК 2P+E 16A 250V~ BV	194
VE40-XO	КОНТАКТ ФРЕНСКИ 2P+E 16A 250V~ XO	195
VE41-XO	КОНТАКТ ФРЕНСКИ+КАПАК 2P+E 16A 250V~ XO	195
VE42-XO	КОНТАКТ ФРЕНСКИ 2P+E 16A 250V~ BV XO	195
VE43-XO	КОНТАКТ ФРЕНСКИ+КАПАК 2P+E 16A 250V~ BV XO	195
VE40-	КОНТАКТ ФРЕНСКИ 2P+E 16A 250V~	195
VE41-	КОНТАКТ ФРЕНСКИ+КАПАК 2P+E 16A 250V~	195
VE42-	КОНТАКТ ФРЕНСКИ 2P+E 16A 250V~ BV	195
VE43-	КОНТАКТ ФРЕНСКИ+КАПАК 2P+E 16A 250V~ BV	195
VE16-	ДВОЕН КОНТАКТ ШУКО 2P+E 16A 250V~	196
VE46-	ДВОЕН КОНТАКТ ФРЕНСКИ 2P+E 16A 250V~	196
VE30-	КОНТАКТ 2P 16A 250V~	196
КОМУНИКАЦИИ KE		
KE11	КОНЕКТОР ЗА ТВ-РАДИО КРАЕН 1 dB	197
KE12	КОНЕКТОР ЗА ТВ-РАДИО ПРЕХОДЕН 10 dB	197
KE16	КОНЕКТОР ЗА САТЕЛИТНА ТВ-РАДИО КРАЕН 3 dB	197
KE36	КОНЕКТОР TEL KS RJ11 6/4	197
KE37	КОНЕКТОР CAT5e KS RJ45 8/8	198
KE40	КОНЕКТОР CAT6s KS RJ45 8/8 SLIM	198
KE38	ДВОЕН КОНЕКТОР TEL KS 2x RJ11 6/4	198
KE39	ДВОЕН КОНЕКТОР CAT5e KS 2x RJ45 8/8	198
KE41	ДВОЕН КОНЕКТОР CAT6s KS 2x RJ45 8/8 SLIM	198
KE45	ЕДИНИЧЕН АДАПТЕР KS	198
KE46	ДВОЕН АДАПТЕР KS	199
KE47	ДВОЕН АДАПТЕР PD	199
KE10-	КОНЕКТОР ЗА ТВ ОСНОВЕН 0 dB	200
KE11-	КОНЕКТОР ЗА ТВ-РАДИО КРАЕН 1 dB	200
KE12-	КОНЕКТОР ЗА ТВ-РАДИО ПРЕХОДЕН 10 dB	200
KE16-	КОНЕКТОР ЗА САТЕЛИТНА ТВ-РАДИО КРАЕН 3 dB	200
KE22-	КОНЕКТОР ЗА АУДИОСИГНАЛИ 2xRCA	200
KE23-	КОНЕКТОР ЗА ВИСОКОГОВОРИТЕЛИ	200
KE36-	КОНЕКТОР TEL KS RJ11 6/4	200
KE37-	КОНЕКТОР CAT5e KS RJ45 8/8	201
KE40-	КОНЕКТОР CAT6s KS RJ45 8/8 SLIM	201
KE38-	ДВОЕН КОНЕКТОР TEL KS 2x RJ11 6/4	201
KE39-	ДВОЕН КОНЕКТОР CAT5e KS 2x RJ45 8/8	201
KE41-	ДВОЕН КОНЕКТОР CAT6s KS 2x RJ45 8/8 SLIM	201
KE35-	КОНЕКТОР TEL LT RJ11 6/4	201

код	описание на продукта	страница
КАПАЦИ РЕ		
PE10-	ПАНЕЛ ЗА ТВ-РАДИО 2P/3P	202
PE20-	ЕДИНИЧЕН ПАНЕЛ KS	202
PE21-	ДВОЕН ПАНЕЛ KS	202
PE30-	ПАНЕЛ TAE/TDO	202
ЕЛЕКТРОНИКА ЕЕ		
EE15	ДИМЕР, ВЪРТЯЩ ТИП ДВУПОСОЧЕН RL 400 W	203
EE16	ДИМЕР, ВЪРТЯЩ ТИП ДВУПОСОЧЕН RLC 400 W	203
EE19	ДИМЕР, ВЪРТЯЩ ТИП ДВУПОСОЧЕН RLC 100 W	204
EE32	IR КЛЮЧ 5 A 230V~	204
EE67	USB ЗАХРАНВАЩ БЛОК 5V 2,4A	204
EE15-	ДИМЕР, ВЪРТЯЩ ТИП ДВУПОСОЧЕН RL 400 W	205
EE16-	ДИМЕР, ВЪРТЯЩ ТИП ДВУПОСОЧЕН RLC 400 W	205
EE19-	ДИМЕР, ВЪРТЯЩ ТИП ДВУПОСОЧЕН RLC 100 W	205
EE32-	КЛЮЧ IR 5A 230V~	205
EE67-	USB ЗАХРАНВАЩ БЛОК 5V 2,4A	206
ПАНЕЛИ ЗА ЕЛЕКТРОНИКА РЕ		
PE41-	ПАНЕЛ ЗА ДИМЕР Ø6	208
PE32-	ПАНЕЛ IR КЛЮЧ	208
PE67-	КАПАК ЗА USB ЗАХРАНВАЩ БЛОК	208
ПРИНАДЛЕЖНОСТИ АЕ		
AE10-	КАПАЧЕ	209
AE20-	СЪЕДИНИТЕЛНА КОНЗОЛА 5POLE 3P+N+E 5x4 mm ²	209
AE30-	КОНЗОЛА ЗА ВЪНШЕН МОНТАЖ 1	209
AE31-	КУТИЯ ЗА МОНТАЖ НА ПОВЪРХНОСТИ ЗА ДВОЕН КОНТАКТ	209
AE50-	СТЕННА ЗАЩИТА	210
AE51-	ЗАЩИТА ЗА ДЕЦА KS	210
РАМКИ ОЕ		
OE10-	РАМКА ЕКОНОМИК 207	211
OE20-	РАМКА ЕКОНОМИК 2 ХОРИЗОНТАЛНА	211
OE21-	РАМКА ЕКОНОМИК 2 ВЕРТИКАЛНА	211
OE30-	РАМКА ЕКОНОМИК 3 ХОРИЗОНТАЛНА	211
OE31-	РАМКА ЕКОНОМИК 3 ВЕРТИКАЛНА	212
OE40-	РАМКА ЕКОНОМИК 4 ХОРИЗОНТАЛНА	212
OE41-	РАМКА ЕКОНОМИК 4 ВЕРТИКАЛНА	212
OE50-	РАМКА ЕКОНОМИК 5 ХОРИЗОНТАЛНА	212
OE90-	ЦВЕТНИ ДЕКОРАТИВНИ РАМКИ	213
fontana		
код	описание на продукта	страница
КЛЮЧОВЕ SF		
SF10-	КЛЮЧ 1WAY IP44 10AX 250V~	216
SF10-TI	КЛЮЧ 1WAY IP44 10AX 250V~ TI	216
SF11-TI	БУТОН 1WAY IP44 10A 250V~ TI	216
SF20-	КЛЮЧ 2POLE IP44 10AX 250V~	216
SF50-	КЛЮЧ 2GANG-1WAY IP44 10AX 250V~	217
SF51-	БУТОН 2GANG-1WAY IP44 10A 250V~	217
SF60-	КЛЮЧ 2WAY IP44 10AX 250V~	217
SF60-TI	КЛЮЧ 2WAY IP44 10AX 250V~ TI	217
SF63-	ДВОЕН КЛЮЧ 2WAY 10AX 250V~	217
SF70-	КРЪСТАТ КЛЮЧ IP44 10AX 250V~	217
КОНТАКТИ VF		
VF10-	КОНТАКТ ШУКО+КАПАК IP44 2P+E 16A 250V~	218
VF12-	КОНТАКТ ШУКО+КАПАК IP44 2P+E 16A 250V~ BV	218
КОМПЛЕКТИ CF		
CF10-	КОМПЛЕКТ КОНТАКТИ ШУКО ДВОИНИ ХОРИЗОНТАЛНИ IP44 2x2P+E 16A 250V~	219
CF11-	КОМПЛЕКТ КОНТАКТИ ШУКО ДВОИНИ ВЕРТИКАЛНИ IP44 2x2P+E 16A 250V~	219
CF12-	КОМПЛЕКТ КОНТАКТИ ШУКО+КЛЮЧ 2WAY ХОРИЗОНТАЛНИ IP44 16A + 10AX 250V~	219
CF13-	КОМПЛЕКТ КОНТАКТИ ШУКО+КЛЮЧ 2WAY ВЕРТИКАЛНИ IP44 16A + 10AX 250V~	220
CF14-	КОМПЛЕКТ КОНТАКТИ ШУКО ДВОИНИ ХОРИЗОНТАЛНИ IP44 2x 2P+E 16A 250V~ BV	220
CF15-	КОМПЛЕКТ КОНТАКТИ ШУКО ДВОИНИ ВЕРТИКАЛНИ IP44 2x 2P+E 16A 250V~ BV	220
CF16-	КОМПЛЕКТ КОНТАКТИ ШУКО+КЛЮЧ 2WAY ХОРИЗОНТАЛНИ IP44 16A + 10AX 250V~ BV	220
CF17-	КОМПЛЕКТ КОНТАКТИ ШУКО+КЛЮЧ 2WAY ВЕРТИКАЛНИ IP44 16A + 10AX 250V~ BV	220
ПРИНАДЛЕЖНОСТИ АФ		
AF10-	РАЗПРЕДЕЛИТЕЛНА КУТИЯ IP44 RN01	221
AF20-	РАЗПРЕДЕЛИТЕЛНА КУТИЯ IP55 ND01	221



TEM

On | Off and everything in between

100% ELEKTRIČEN

www.tem.si

TEM

On|Off and everything in between



www



TEM

TEM ČATEŽ d.o.o.
Čatež 13, 8212 VELIKA LOKA
SLOVENIJA
tem@tem.si
www.tem.si

T +386(0)7 348 99 00

TEM

BG

www.tem.si

